



PSA Cards 2.4 for Windows

Contents Copyright © 1993-1995 by William L. Rogers

Click on a topic to see more or use the browse buttons (>> and << above).

[Introduction](#)

[Summaries](#)

[How To...](#)

[Menus](#)

[Opening a File](#)

[Merging PSA Cards files](#)

[ASCII Import](#)

[Export and Mail Merge](#)

[Auto Clipboard](#)

[Saving a File](#)

[Printing Cards](#)

[Printing Envelopes](#)

[Printing Labels](#)

[Printing Address Books](#)

[Searching](#)

[New Entries](#)

[Editing Old Entries](#)

[Divider Tabs](#)

[The Clipboard](#)

[Entry Groups](#)

[Object Linking and Embedding \(OLE 2.0\)](#)

[Phone Dialer](#)

[Toolbar](#)

[Keyboard and Mouse Shortcuts](#)

[Registering PSA Cards](#)



PSA Cards 2.4 for Windows Introduction

PSA Cards is an easy to use address program. It looks like a card file and it works like a card file. Just click on a divider tab or card to open or close it. PSA Cards can print Rolodex cards, print envelopes, print mailing labels, print address books, and dial phone numbers. PSA Cards also has a facility for dated information such as birthdays, anniversaries, or appointments. You can ask PSA Cards to remind you when a date is about to occur. Other features include merging two PSA Cards files, importing data from an ASCII file or Microsoft CardFile, exporting any field (including mail merge lists) to a file or the clipboard for use in other applications, and the ability to create groups of entries for organizing various types of lists. These lists can be used to address Christmas cards, invitations, and to export addresses for mail merge in a word processor. There are no inherent limits on the number of entries or lengths of fields.

PSA Cards is also an OLE 2.0 container application. This means that you can link or embed objects (pictures, maps, documents, sound and video clips) created in other programs in your PSA Cards entries. See the [OLE Summary](#) for more information about this exciting new technology.

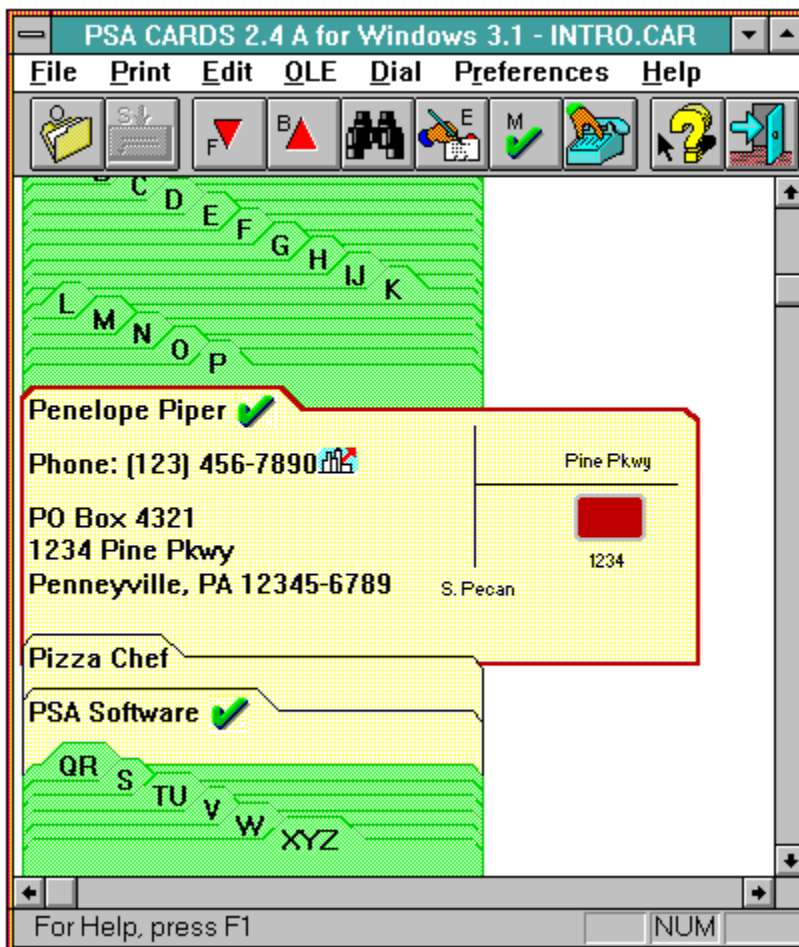

For a list of how to accomplish some common operations see [Common Tasks](#)

For an index of commands see [Menus and their Commands](#)

Some commands are also available from the **[Toolbar](#)** and from the **[Keyboard](#)**.

The [Summaries](#) topic contains links to overviews of how to use PSA Cards.

You can also click on various parts of this sample PSA Cards window to find out what they do.

Summaries

[Creating a New Entry](#)

[Moving around in the file and selecting entries.](#)

[I/O Summary](#)

[Printing Summary](#)

[Using Check Marks](#)

[Using Groups](#)

[Clipboard Summary](#)

[OLE Summary](#)

Common Tasks

How to:

[Add dated information](#)
[Add more phone numbers](#)
[Add a work address](#)
[Backup a data file](#)
[Change the printer font](#)
[Change the screen Font](#)
[Change the size of the Toolbar buttons](#)
[Clear Check Marks](#)
[Copy an address to the clipboard](#)
[Dial a phone number](#)
[Enter a card](#)
[Edit a card](#)
[Edit dividers](#)
[Edit groups](#)
[Enter the name of a business](#)
[Find someone](#)
[Import data from another program](#)
[Import data from MS CardFile.](#)
[Merge two Card files](#)
[Move around in the file and select entries](#)
[Open a divider or card from the keyboard](#)
[Print address books](#)
[Print cards](#)
[Print envelopes](#)
[Print labels](#)
[Register PSA Cards](#)
[Save a subset of entries](#)
[Search any field](#)
[Select an entry for Printing](#)
[Select a group of entries for Printing](#)
[Setup a return address for envelopes](#)
[Use Object Linking and Embedding \(OLE\)](#)

Menus and Their Commands

Commands

File menu

Print menu

Edit menu

OLE menu

Dial menu

Preferences menu

Help menu

System menu

Toolbar

Keyboard Shortcuts

Summaries

File menu commands

The File menu offers the following commands:

<u>New</u>	Creates a new Card file.
<u>Open</u>	Opens an existing Card file.
<u>Merge</u>	Merges the current Card file with another one.
<u>Import</u>	Imports an address file from another program
<u>Export</u>	Exports any field(s) to a text file.
<u>Save</u>	Saves an opened Card file using the same file name.
<u>Save As</u>	Saves a PSA Cards file to a specified file name.
<u>Backup</u>	Backs up the current file.
<u>Recent File</u>	Opens one of the four most recently used PSA Cards files.
<u>Exit</u>	Exits PSA Cards .

See Also: [I/O Summary](#)

Print menu commands

The Print menu offers the following commands:

<u>Setup Ret Addr</u>	Brings up the return address dialog box for entering the envelope return address.
<u>CMark</u>	Sets the <u>Check Mark</u> for the current entry.
<u>CMark Wrk Addr - 1st</u>	Use the first person's work address for envelopes
<u>CMark Wrk Addr - 2nd</u>	Use the second person's work address for envelopes
<u>CMark All</u>	Set Check Marks for all entries.
<u>CMark Updates</u>	Marks all entries modified after a certain date.
<u>Clear All CMarks</u>	Clears all selection marks from all entries.
<u>Toggle CMarks</u>	Marks unmarked entries and unmarks marked entries.
<u>Print Preview - Cards</u>	Displays the cards as they would appear printed on file cards.
<u>Print Preview - Envelopes</u>	Displays envelopes as they would appear printed.
<u>Print Preview - Labels</u>	Displays labels as they would appear printed.
<u>Print Preview - Address Book</u>	Displays address book as it would appear printed
<u>Print - Cards</u>	Prints either selected entries or all entries as file cards.
<u>Print - Envelopes</u>	Prints envelopes either for selected entries or all entries.
<u>Print - Labels</u>	Prints labels either for selected entries or all entries.
<u>Print - Address Book</u>	Prints address book for selected entries or all entries
<u>Print Setup</u>	Selects the printer and printer driver

See Also:

[Printing Summary](#)
[Using Check Marks](#)

Edit menu commands

The Edit menu offers the following commands:

<u>Locate</u>	Click on this to search for someone's name
<u>Edit Cur Entry</u>	Click on this to modify the currently selected entry
<u>New Entry</u>	Click on this to start a new residential entry
<u>New Business</u>	Click on this to start a new business entry
<u>Duplicate</u>	This command duplicates the current entry.
<u>Clipboard</u>	Use this to copy text from an <u>open entry</u> to the clipboard.
<u>Edit Cur Divider</u>	Use this command to modify the currently selected <u>divider</u>
<u>New Divider</u>	Click on this to create a new divider
<u>Remove Cur Entry</u>	Use this to delete the currently selected entry
<u>Remove Cur Divider</u>	Click on this to delete the currently selected divider
<u>Remove CMark Entries</u>	Deletes all entries with Check Marks.
<u>Edit Groups</u>	Use to change the list of entries in each group.
<u>Display Groups</u>	Use to toggle display of an entry's membership in groups.
<u>Show Only Cur Grp</u>	Use to toggle display of all entries or just entries in the current group.

See Also:

[Creating a New Entry](#)

[Using Check Marks](#)

[Using Groups](#)

OLE menu commands

The Object Linking and Embedding menu offers the following commands:

<u>Hide OLE</u>	Hides or displays OLE items
<u>Enable OLE</u>	Enables or disables move or resize of OLE items
<u>Move/Resize</u>	
<u>Toggle Iconic</u>	Toggles an OLE item between its iconic and graphic representations
<u>Copy Object</u>	Copy currently selected OLE item to clipboard
<u>Paste Object</u>	Paste clipboard OLE item into currently selected card
<u>Paste Object Link</u>	Paste clipboard OLE link into currently selected card
<u>Delete Object</u>	Delete currently selected OLE item or link
<u>Insert New Object</u>	Insert an OLE item or link into the currently selected card
<u>Object Links</u>	Object link
<u>OLE Verbs</u>	Play, edit, or activate currently selected OLE item

See Also: [OLE Summary](#)

Dial menu commands

The dial menu offers the following commands:

<u>Dial Number</u>	Dials a telephone number
<u>End Call</u>	Hangs up modem or aborts redial on busy signal
<u>Dialing Setup</u>	Setup dialog for automatic dialing

Preferences menu commands

The Preferences menu offers the following commands:

<u>Toolbar</u>	Shows or hides the toolbar.
<u>Status Bar</u>	Shows or hides the status bar.
<u>Sounds</u>	Toggles sounds on and off.
<u>Screen Font</u>	Select screen font
<u>Address Pref</u>	Set preference for PO Box or street address
<u>Toolbar Size</u>	Change the toolbar button size
<u>CMark Preferences</u>	Change the order of address selection within and entry.

Help menu commands

The Help menu offers the following commands, which provide you assistance with this application:

<u>Contents</u>	Table of contents for on-line help.
<u>Using Help</u>	Provides general instructions on using help.
<u>About</u>	Displays the version number of this application.
<u>Register...</u>	Register PSA Cards with PSA Software.

System menu commands

The System menu commands are accessed by clicking on the System menu button in the title bar:



The system menu commands are used to control the location and size of the application's window and to exit the application or switch to another application.

<u>Restore</u>	Restore the window to its size before using the Minimize or Maximize commands
<u>Move</u>	Move the window with arrow keys
<u>Size</u>	Change the window size with arrow keys
<u>Minimize</u>	Reduce the window to an icon
<u>Maximize</u>	Enlarge the window to its maximum size
<u>Close</u>	Close the window
<u>Switch To</u>	Switch to another application

Shortcuts

Keys: Alt+Spacebar

Input / Output Summary

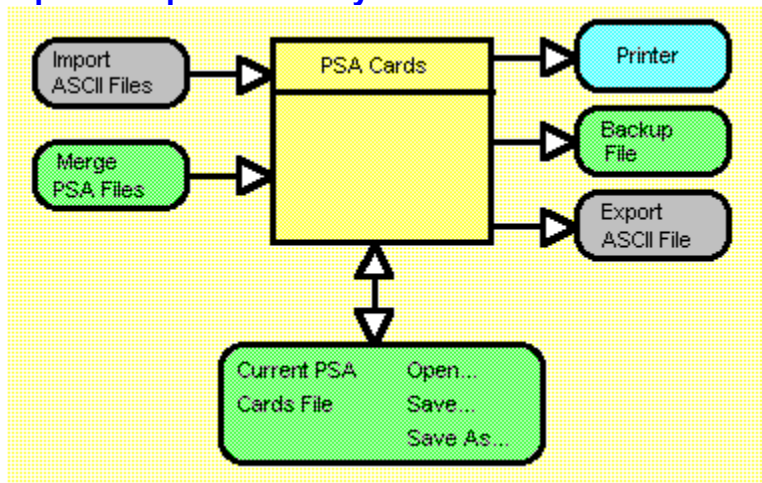

PSA Cards can read and write several types of files and send text and images to the printer. This topic is intended to summarize and clarify the relationships between PSA Cards and its files.

Besides the keyboard and mouse, PSA Cards can get input from an ASCII import file; or by Merging two PSA Cards files; or by reading an existing PSA Cards file with the Open command. A PSA Cards file is a specially formatted binary file used by PSA Cards to store information. It can only be read and written by PSA Cards. It contains your card entries and embedded (OLE) objects. Its file type is *.car. It is distinct from, and separate from, both the ASCII Import file and the ASCII Export file. The Import and Export files are plain text files that are used to move data in and out of the PSA Cards environment. They should not be confused with PSA Cards files. For instance, writing Export data to a PSA Cards file will destroy it and cause the loss of all the data it contains. The program attempts to prevent such accidents, but cannot guarantee protection from a really determined user.

Changes, imported data, and merged information are saved in the current PSA Cards file using the Save command. The Save As command is used to save the information currently in PSA Cards in a new or different file. The file used in the Save As command becomes the current file. The name of the current file will appear in the title bar of the main window.

Information is also output from the program to the printer, to PSA Cards backup files, and to ASCII export files. The backup file is also a PSA Cards file. It is normally written to a different disk than the current PSA Cards file's disk. If there is some mishap with the current file the backup file can be read with the Open command. ASCII export files can be listing files suitable for editing with a word processor or text editor, tab delimited files suitable for input to a spreadsheet program, or mail merge files for producing form letters with a word processor.

New command (File menu)

Use this command to create a new PSA Cards file.
You can open an existing card file with the Open command.

See Also: I/O Summary

Open command (File menu)

Use this command to open an existing [PSA Cards file](#). This command displays the [File Open](#) dialog box. You can create new card files with the [New command](#).

Shortcuts



Toolbar:
Keys: Ctrl+O

See Also:

[I/O Summary](#)

Merge command (File menu)

If you keep your addresses in two different files -- perhaps on two different computers, it is difficult to keep the files consistent with each other. The merge command can help with this problem.

This command is used to merge the currently open file with another PSA Cards file. When you click on this command, a File Open dialog box is displayed. Select the file you want to merge. PSA Cards then displays the File Merge dialog box. This box is used to control whether or not changes are marked and whether or not you want to **verify** each change. If you want only changes marked, clear all the Check Marks (Print menu) before executing this command. You can also specify how entries with the same name but different data are handled. If you pick the **Keep Newest** button, the entry that was modified last will be kept. The **Keep Both** button will keep both entries so that you select which one to delete after the merge is completed.

If you ask to have each change verified, a Change Verification dialog box will be displayed for each entry to be changed.

If you have embedded or linked objects (OLE items) in file being merged with the current file, you may, in some unusual circumstances, get an error message that says Failed to clone merged OLE item. This means that the program could not copy an OLE item from one file to the other. The copy of the current file in memory may also be corrupted and you should NOT save it disk. To complete the merge, you should exit and re-execute PSA Cards, open the file you are trying to merge, delete the OLE items in the problem entry, save the file, open the original file, and retry the merge operation.

The merged file is not written to disk until you execute Save or Save As.

See Also: I/O Summary

Change Verification dialog box

This dialog box is used to verify whether or not you want a given change to be made during a file merge. If you want the proposed change completed, click **Yes**, if not click **No**. If you want all the rest of the changes in the merge completed without further verification, click **Yes to All**. After the merge you have the option of discarding all the changes by simply not updating your PSA Cards file.

File Open dialog box (File menu)

The following options allow you to specify which file to open:

File Name

Type or select the filename you want to open. This box lists files with the extension you select in the List Files of Type box.

List Files of Type

Select the type of file you want to open: PSA Cards uses file types *.crd for PSA Cards files, *.adr for import files, and *.txt for export files.

Drives

Select the drive in which PSA Cards stores the file that you want to open.

Directories

Select the directory in which PSA Cards stores the file that you want to open.

Network...

Choose this button to connect to a network location, assigning it a new drive letter.

This dialog box is invoked by:

File Open command

File Merge command

File Import command

See Also:

I/O Summary

Import command (File menu)

This command is used to import data from another program. The file to be imported must be an ASCII file, i.e., a simple text file. The first character in the file is the character that is used to **delimit** fields in the file's data records. The rest of the first line of the file has the field names for each record in the file. The field names must be from the following list:

fname1	First name, name one
lname1	Last name, name one
nname1	Nickname, name one
fname2	First name, name two
lname2	Last name, name two
nname2	Nickname, name two
street	Street address
city	Name of city
state	Name of state
zip	ZIP code
area_code1	Area code for first phone number
phone1	First phone number
area_code2	Area code for second phone number
phone2	Second phone number
comment	Miscellaneous information

The field names can be in any order and must be in all lower case, spelled exactly as in the above list. The field names may be separated by a blank, a comma or the delimiter character. At least one of either **fname1** or **lname1** must be present.

If the area code is contained within the phone number and is delimited by () or by the first of two hyphens (see [examples](#)), the **area_code1** and/or **area_code2** fields may be omitted. If the area code is embedded in the phone number and the area code field name is omitted, PSA Cards will attempt to extract it during the import process.

If a **phone number** does not have an area code, the resulting area code field will be empty. If you want to supply a default area code for phone numbers which do not have area codes, add the string: `deflac=nnn` to the end of the first line in the file. Be sure to include a blank (space) between the last field name and `deflac=nnn`. `nnn` is the three digit default area code.

The data records follow the field list, one line for each entry. The data in each field must be separated by the **delimiter** character. This character is normally a tab, but can be any character that is not present anywhere in the data and is not a carriage return or newline character. Use successive delimiters for missing fields. Every record (line) must have the same fields.

Double quotation marks can be used to force PSA Cards to ignore delimiter characters that may be embedded in data fields. This likely to happen if the delimiter is a comma. If the data for a field begins and ends with double quotes, any delimiters between the two double quotes will be ignored. This is the default behavior. If this is not what you want, add the string:

ignore quotes

to the end of the first line. Double quotes will then be treated like any other character.

Normally one uses this import feature by editing the field description (first line) into an existing text file that has been written by another program. Data from Microsoft's CardFile program can be imported using the DOS utility program [CONVERT](#).

Shortcut

Keys: Ctrl+I

See Also:

[I/O Summary](#)

Importing data from Microsoft CardFile

There is a DOS utility program called CONVERT that can be used to convert a file written by Microsoft CardFile to an ASCII format which can be read into PSA Cards using the Import command. This program is documented more fully in the README.TXT file which accompanies PSA Cards.

Export command (File menu)

This command is used to export data to an ASCII file and to set up the Auto Clipboard feature. It brings up the Export dialog box. Data from any field or names and addresses formatted for mail merge can be written to an ASCII file for any entry or group of entries. The Auto Clipboard feature can be set up to copy any field or combination of fields to the clipboard each time an entry is opened.

Shortcut:

Keys: Ctrl+X

See Also:

[I/O Summary](#)

Export dialog box (File menu)



PSA Cards is designed to do three kinds of data export to an ASCII text file:

1. **Mail merge** to a word processing program.
2. **Fixed number of fields** in each record and with a header record.
3. A **data listing** to a file with carriage returns between data items.

Mail Merge

A mail merge file can be used in a word processing program to prepare form letters to a list of people or companies. To export names and address for mail merge, check the mail merge box and clear all the others in the **Export** column of checkboxes. The delimiters for the **Export Fields** and **Export Entries** should be a tab (\t) and carriage return new-line (\r\n) respectively. In the **File Export Only** section, clear all the check boxes but the one labeled **Fixed Number of Fields**. Use the radio buttons to indicate if you want to export every entry or just the ones with Check Marks. Finally click on the **Export** button.

PSA Cards will write a file with a header record (line) to define the following fields:

Envl1	(First line of <u>envelope title</u> field of an address)
Envl2	(Second and subsequent lines of envelope field)
Street or POB	(Street number and name field or PO Box)
City	(City field)
State	(State field)
ZIP	(ZIP code field)
FirstName	(First name(s) from Name fields)
LastName	(Title and Last name(s) from Name fields)

The FirstName exported field is intended to be used for the a letter's informal salutation as in Dear Fred. The LastName exported field is intended for a formal salutation as in Dear Mr. Jones. The Envl1, Envl2, Street, City, State, and ZIP are to be used to form the address portion of the letter above the salutation. PSA Cards attempts to extract text strings from the envelope title field, the First Name, Last Name, and Nick Name fields of both the names in an entry to form sensible names for a letter's salutation. The rules used to do this are complex and are not guaranteed to always produce a satisfactory result.

How to set up entries for the best mail merge results. This section refers the new entry and edit entry commands in the Edit Menu. For every entry that contains a person's name, put a form of address such as Mr., Dr. or MD in the first line of the envelope title field in the address group. Enter businesses as businesses not as residences. Use Messrs. in the envelope title for two men in the same entry and Mmes. for two women in the same entry. If there are two people in an entry, use both Name One and Name Two. Put nicknames in the Nick Name field -- not after the first name in the First Name field. If a person uses their middle name for a first name as in J. Alfred, put Alfred in the Nick Name field as well as the First Name field. Put modifiers such as Jr. or III after the last name in the Last Name field. You can preview the effect on mail merge of changes in an entry by using the Auto Clipboard feature described below. Check the Auto Clipboard Mail Merge box. Then after editing an entry (Edit menu) use the

Alt+Shit+C keys to look at the mail merge fields for the entry.

Your **word processing program** should have a facility for importing these names and addresses in a mail merge operation. To find out how to use mail merge in Word 6.0, use the main search command in the Help menu to look for Mail Merge, then choose the topic: Mail Merge: Step by Step. You should, of course, check each and every letter's address and salutation. PSA Cards attempts to generate reasonable names and addresses. However a computer program that deals with something like addressing letters will, sooner or later, do something that is egregiously stupid. We've all received form letters with computer generated blunders in them.

Fixed Number of Fields

The fixed number of fields file is for generalized input to another program. An example would be a file with names and phone numbers for input to a Personal Digital Assistant (PDA). To create such a file, check the boxes under Export for the kinds of data you want to export. If the data includes an address, be sure to check the **Divide Address** box in the File Export Only group. This will replace the carriage returns inside the address with field delimiters and will result in separate exported title, company, P O Box, street, city, state, and Zip fields. If you want names divided into first name and last name; or phone numbers divided into area codes and numbers, check the **Divide Names** or **Divide Phone Numbers** boxes.

The number of fields in each record will depend on the Export and Divide boxes checked, and the maximum number of phones, and dated fields in any of the entries being exported. If phones or dated fields are exported, all the entries to be exported are scanned first for the maximum number of phones or dated entries. Then each entry's record is written with the same number of fields. If the information for a field is missing, the field is represented by two successive delimiter characters. The **Export Entries** (end of record) delimiter should be a carriage return, newline sequence of characters.

Once you have written the export file, you can edit it with a text editor. A spreadsheet program can also be used to rearrange and delete fields (spreadsheet columns). Using a tab for the **Export Fields** delimiter will make it easier to load the export file into the spreadsheet.

Data Listing

The data listing format is intended for general use in a text editor or word processor. Use carriage return-linefeed for both the field delimiter and the entry delimiter. Clear the Fixed Number of Fields and Divide Address checkboxes. Then you will get a file with each data item on a separate line and a blank line between entries. Addresses will appear in their natural format.

The Check Mark is used with the **Export only marked entries** radio button. If you want to export a work address, use the work address Check Mark. If you want to export all of the entries in a PSA Cards file, click on the **Export all entries** radio button.

When you click the **Export** button, a file dialog box is displayed. Use this dialog box to indicate the path and name of the ASCII text file for the exported data. This file is **NOT** the PSA Cards file (file type *.car). If you write exported data to a PSA Cards file, all the information in the PSA Cards file will be overwritten and destroyed.

The Auto Clipboard

The Auto Clipboard feature can be used to automatically load a field or fields into the clipboard each time an entry is opened. Select the desired information by checking the boxes under **Auto Clipboard**. This feature is handy if you write a lot of letters. You can have a name and address ready to paste in your word processor just by clicking on an entry. If you send a lot e-mail, you can select the e-mail field to be loaded each time an entry is opened.

Each time the clipboard is loaded, you will hear a beep. This is to remind you that this feature is turned on and is changing the contents of the clipboard. To turn off the beep, uncheck the Sounds command in the Preferences menu. To turn off the auto clipboard feature, clear all the Auto Clipboard boxes in this dialog.

You can look at and edit the current text in the clipboard by using the Clipboard command (Alt+Shift+C) in the Edit menu. You can also Ctrl+Click directly on data in entries in the main window to load it to the clipboard. See the clipboard summary topic for more information about this feature.

See Also: I/O Summary

Mail Merge - How it Works

Since the FirstName exported field is for an informal salutation, the program will use the Nick Name field if it is not empty. Otherwise, the First Name field is used. If the entry is for a residence, the data in Name One is used. If the entry is for a business, Name Two is used since that is the Contact Name. If the envelope title field or name fields contain information about a person's title (such as Mr., Dr., MD, Col. and so on), the program will attempt to form an appropriate formal salutation such as Dr. Welby or Mr. Smith for the exported LastName field. If there is some indication that the letter is addressed to more than one person such as the text strings Mr. and Mrs., Messrs., Mmes., or just the word and, the program will try to form salutations with both names. This results in FirstName exported fields such as Bob and Sally; and LastName exported fields such as Dr. and Mrs. Welby, or Messrs. Smith and Jones.

What happens if an entry has exported fields that are empty? If the envelope title field of the entry is empty, the first and last names from Name One are used for Env1 and the Env2 field is empty. When the program can't find anything to put in the FirstName or LastName field, the string Sir is used.

What happens to initials? If the FirstName field has trailing initials such as in John J., the first blank and everything after it are dropped. If FirstName starts with an initial (people who use initials in place of their first name), it is not changed. If a person's form of address (such as Mr.) is included in an entry's First Name field, or in an entry's Last Name field (such as MD), the program will remove it before copying the name to the exported FirstName or LastName field and will use it to form a title for the exported LastName field. If a person uses their middle name for a first name as in J. Alfred, put Alfred in the Nick Name field as well as the First Name field. Then the informal salutation will be Dear Alfred, not Dear J. Alfred. If a person's first name is two words such as Billy Bob, the program will keep the second word. Since there is no way to distinguish between this case and a spelled out middle name, use the middle initial when creating or editing an entry rather than spelling out the middle name.

What happens if both street and PO Box are present? Either the street address or the post office box are used. Use the Address Pref command to control the choice for this case.

Save command (File menu)

Use this command to save your work to its current file name and directory. When you save for the first time, PSA Cards displays the Save As dialog box so you can name your PSA Cards file. If you want to change the name and directory of an existing card file before you save it, choose the Save As command.

Shortcuts



Toolbar:
Keys: Ctrl+S

See Also:

[I/O Summary](#)

Save As command (File menu)

Use this command to save and name your PSA Cards file. PSA Cards displays the Save As dialog box so you can name your card file.

To save a card file with its existing name and directory, use the Save command.

See Also: I/O Summary

File Save As dialog box (File menu)

The following options allow you to specify the name and location of the file you're about to save:

File Name

Type a new filename to save a PSA Cards file with a different name. PSA Cards adds the extension you specify in the Save File As Type box.

Drives

Select the drive in which you want to store the card file

Directories

Select the directory in which you want to store the card file

Network...

Choose this button to connect to a network location, assigning it a new drive letter.

This dialog box is invoked by:

File Save command

File Save As command

Export command

See Also:

I/O Summary

Backup command (File menu)

Use this command to back up the current PSA Cards file to another disk and/or directory. It brings up the Backup Directory dialog box.

See Also: I/O Summary

Backup Directory dialog (Backup command)

Enter the disk and directory path where you want to back up the current PSA Cards file. The current file will be backed up to that directory using the current file name.

The **Reminder Frequency** is the number of changes to the file before you are reminded to back it up. The number of changes is checked each time you open a file. If you don't want any backup reminders at all, set the Reminder Frequency to zero. If the backup reminder comes up and you tell the program you don't want to do a backup, the number of accumulated changes is reduced so that you will not be reminded again right away.

See Also: I/O Summary

1, 2, 3, 4 command (File menu)

Use the numbers and filenames listed at the bottom of the File menu to open the last four PSA Cards files you closed. Choose the number that corresponds with the file you want to open.

See Also: I/O Summary

Exit command (File menu)

Use this command to end your PSA Cards session. You can also use the Close command on the System menu or tool bar. PSA Cards prompts you to save PSA Cards files with unsaved changes.

Shortcuts

Mouse: Double-click the application's System menu button.



Toolbar:
Keys: Alt+F4

Printing Summary

PSA Cards will print rotary file cards, envelopes, mailing labels, address books, phone books, and listings. Envelopes and mailing labels can have return addresses. Return addresses can be setup using the Return Addresses command. They can also be edited and selected in the Printing Envelopes and Printing Labels dialog boxes. Address books, phone books and listings are selected and printed from the Printing Address Books dialog box.

The printer font can be changed from any of the Print Setup dialog boxes. There is a single printer font selection that applies to all of the print formats. The Print Setup dialog boxes are used to select printing options and to initiate printing or print preview. There are four Print Setup dialog boxes; one for cards, one for envelopes, one for mailing labels, and one for address books. They can be accessed from the Print or Print Preview commands in the Print menu.

Print Preview will display the printed output as it will appear on the printer. You can use it to check your printer output before committing it to paper. The Print Preview Toolbar is used to browse multipage print preview displays and to initiate printing from Print Preview mode.

You can select all of the entries for printing from each of the print setup dialogs or you can print just the entries with Check Marks. See the Check Mark summary for information about setting and using Check Marks.

Using Check Marks

Check Marks are a way tagging individual entries for a variety of operations. Check Marks can be used to indicate which entries are to be printed, or deleted, or exported, or added to a Group.

Check Marks can be set on individual entries by the CMark, and the CMark Work Address commands. The CMark All command will set Check Marks on all the entries and the Clear All CMarks command will remove all Check Marks. The Toggle CMarks command will clear all Check Marks on entries that have them and set Check Marks on entries that don't have them. The CMark Updates command can be used to set Check Marks on all entries that were modified after a specified date.

The Locate, Search Dates, and Edit Groups dialog boxes can set Check Marks depending on search results or group membership. The Edit Groups dialog box can also add Check Marked entries to groups.

The CMark Preferences commands are used to indicate which type of address is to be selected for printing or export to an ASCII file. If there is more than one address in an entry (main address, work addresses) these commands control which one is selected for output when the entry is Check Marked.

The Edit Cur Entry, Duplicate, and Merge commands; and Object Linking and Embedding operations will cause Check Marks to be set for entries that they cause to be modified.

Using Check Marks to Save a Subset of Entries

You can use Check Marks to create a PSA Cards file with a subset of entries from another PSA Cards file. You would need to do this if you want to give someone else a file with only part of your addresses and phone numbers.

First clear all the existing Check Marks. Then select the entries you want to save, using the Check Mark commands described above. After all the entries to be saved have Check Marks, use the Toggle CMarks and Remove CMark Entries commands to delete the entries you don't want on your new file. Last, use the **Save As** command (File menu) to save the remaining entries to a new file. Be sure to use the Save As command. If you use the Save command, the current file will be overwritten with only the entries that you haven't deleted, destroying all the other entries.

Setup Return Address command (Print menu)

This command is used to invoke the Return Address dialog box. You can enter and select up to four different return addresses for envelopes using the Return Address dialog box. The Return Address dialog box can also be accessed from the Envelope Printing Dialog box and the Label Printing Dialog box. PSA Cards saves return the addresses when you update your file.

Check Mark command (Print menu)

Use this command to set and clear entry Check Marks. Check Marks are used to tag entries for various operations. Their most common use is to select entries for printing. Check marks can also be used to form Groups, select entries for export, and flag entries as having been modified. Click on the card you want to have a Check Mark, then click this command. You can also mark a card without opening it by clicking on it with the right mouse button. A Check Mark  will appear at the end of the first line in the entry. These marks are saved when you update your [PSA Cards file](#). Marking an entry that is already selected will clear its Check Mark. Entries can also be marked in the Search, Search Dates, and Edit Groups dialogs.

Shortcuts

Keys: Ctrl+M



Toolbar:

Mouse: Right click on the card.

See Also:

[Check Mark Summary](#)

[Printing Summary](#)

[CMark Work Address for Printing - 1st command](#)

[CMark Work Address for Printing - 2nd command](#)

[Moving around in the file and selecting entries.](#)

Mark Work Address for Printing - 1st command (Print menu)

Use this command to select and deselect entries for printing or exporting work addresses. Click on the entry you want to select, then click this command. A "W1" will appear after the Check Mark at end of the first line of the entry. The work address of the first person in the entry will be used when printing or exporting addresses. These marks are saved when you update your PSA Cards file. Marking a Check Marked entry will clear its Check Mark. This command is disabled if there is work address for the first person in the entry.

See Also:

CMark Work Address for Printing - 2nd command

CMark command

Printing Summary

Using Check Marks

Mark Work Address for Printing - 2nd command (Print menu)

Use this command to select and deselect entries for printing or exporting work addresses. Click on the entry you want to select, then click this command. A "W2" will appear after the Check Mark at end of the first line of the entry. The work address of the second person in the entry will be used when printing or exporting addresses. These marks are saved when you update your PSA Cards file. Marking a Check Marked entry will clear its Check Mark. This command is disabled if there is no work address for the second person in the entry.

See Also:

[CMark Work Address for Printing - 1st command](#)

[CMark command](#)

[Printing Summary](#)

[Using Check Marks](#)

Mark All command (Print menu)

Use this command when you want to set Check Marks on all but a few entries. After setting the Check Mark for all entries, you can deselect the entries you don't want to be included in Check Mark operations. You can toggle a card's Check Mark without opening the card by clicking on it with the right mouse button. If an entry is already Check Marked, this command does not affect it.

See Also:

[CMark command](#)

[Printing Summary](#)

[Using Check Marks](#)

Mark Updates command (Print menu)

This command is used to set the Check Marks for all entries that have been modified after a specified date. When this command is issued the Mark Modified Entries dialog box is displayed. This dialog is used to specify a date and time.

See Also:

[Printing Summary](#)

[Using Check Marks](#)

Mark Modified Entries dialog box (Print menu)

This dialog box is handy when you want to reprint all the cards modified since a given date.

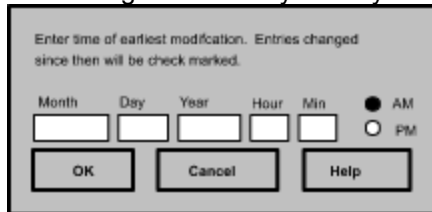

Enter time of earliest modification. Entries changed since then will be check marked.

Month Day Year Hour Min AM PM

OK Cancel Help

The controls in this box are used to set the time of the earliest card modification. When you click OK, Check Marks will be set for cards modified since this time. The new Check Marks are in addition to any existing Check Marks. The date and time set in this dialog will be saved as parts of the PSA Cards file when the file is updated.

See Also:

[Printing Summary](#)

[Using Check Marks](#)

Clear All Check Marks command (Print menu)

Use this command to clear all Check Marks for all entries. This deselects all entries with Check Marks. Check Marks for individual entries can be cleared by selecting the entry (click on it) and using the Check Mark command

See Also:

[Printing Summary](#)

[Using Check Marks](#)

Toggle Check Marks command (Print menu)

This command Check Marks all unmarked entries and clears the Check Marks for all Check Marked entries. This operation is useful in situations where you have done a search that finds all the entries that you don't want to print rather than the ones you do want to print. It can also be used to reverse selections for the [Remove CMark Entries](#) command and in [Group](#) editing.

See Also:

[Printing Summary](#)

[Using Check Marks](#)

Print Preview - Cards command (Print menu)

This command is used to display a preview of what the card entries will look like when printed on Rolodex cards. This command brings up the Card Printing dialog box. This dialog box is used to control whether or not all entries or just selected entries are previewed or printed.

See Also:

Printing Summary

Using Check Marks

Print - Cards command (Print menu)

Use this command to print card entries on Rolodex cards. This command brings up the Card Printing dialog box. This dialog box is used to control various aspects of printing cards, including whether or not all entries or just selected entries are previewed or printed. To find out how to select entries for printing see the Check Mark command

See Also:

Printing Summary

Using Check Marks

Card Printing Dialog box (Print menu)

This dialog box is used to control card printing and print preview.

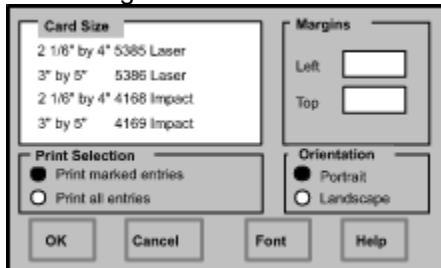

The controls in this dialog box are divided into groups for selecting the card size, setting margins, controlling what is printed, controlling the print orientation, and the OK, Font, Cancel, and Help buttons.

The **Card Size** list box can be used to select 2 1/8 by 4 inch cards or 3 by 5 inch cards for laser or impact printers. Avery supplies both sizes of cards (#5385 or #5386) as perforated card sheets for laser printers or as continuous tractor feed forms (#4168 or #4169). The correct printer driver must be selected for the form type (laser or impact). Use the [Print Setup](#) command to select the printer driver.

Use the **Margin** controls to adjust the position of the printed cards. Enter the margins in inches. Separate margins for both sizes of cards are saved as part of your [PSA Cards file](#).

The **Print Selection** controls whether just the entries with [Check Marks](#) or all entries are printed. See [Check Mark](#) command (Print menu). If no entries are checked, the Print all entries button is selected automatically and both controls are disabled.

Control the **Orientation** of the printed cards by clicking on Portrait or Landscape. Normally you should use portrait mode for printing cards.

The **Font** button can be used change the printer font. It affects the card font as well as the printed label, envelope font, and address book font, but not the screen font. The font selection becomes part of your PSA Cards file. Clicking the font button brings up the [Font dialog Box](#).

When you choose the **OK** button in print preview mode, the main window will be replaced with a print preview window in which one or two pages will be displayed in their printed format. The [print preview toolbar](#) offers you options to view either one or two pages at a time; move back and forth through the card file; zoom in and out of pages; and initiate a print job. If an impact printer form and an impact printer are currently selected, the print preview window will also display the tractor perforations and the proper form width.

If you choose the **OK** button in print mode, cards will be printed.

See Also:

[Printing Summary](#)

[Using Check Marks](#)

Print Preview - Envelopes command (Print menu)

This command is used to display a preview of what envelopes will look like when printed. This command brings up the Envelope Printing dialog box. Use this dialog box to control various aspects of envelope printing, including whether or not all entries or just selected entries are previewed or printed. To find out how to select entries for printing see the Check Mark command

See Also:

Printing Summary

Using Check Marks

Print - Envelopes command (Print menu)

This command is used to print envelopes. This command brings up the Envelope Printing dialog box. Use this dialog box to control various aspects of envelope printing, including whether or not all entries or just selected entries are previewed or printed. To find out how to select entries for printing see the Check Mark command

See Also:

Printing Summary

Using Check Marks

Envelope Printing Dialog box (Print menu)

This dialog box is used to control envelope printing and print preview for envelopes.

The dialog box is titled "Envelope Printing Dialog box (Print menu)". It contains several sections:

- Envelope Size:** Radio buttons for "Com 10 (4 1/8 by 9 1/2)", "Personal (3 5/8 by 6 1/2)", "Invitation (5 by 7)", and "User Specified". Below "User Specified" are input fields for "Width:" and "Height:".
- Print Selection:** Radio buttons for "Print marked entries" and "Print all entries".
- Margins:** Input fields for "Left:" and "Top:".
- Orientation:** Radio buttons for "Portrait", "Landscape Top Left", and "Landscape Top Right".
- Return Addr:** An "Edit" button and a text area containing the address: "Mr and Mrs. Fred Foo", "1234 Baja Vista", "Fooville, CA 9500".
- Buttons:** "Font", "Help", "Cancel", and "OK" buttons are located on the right side.

Use the **Envelope Size** buttons to select the envelope you are printing. If you need a special size, click the User Specified button and enter the envelope size in inches.

The **Print Selection** radio buttons tell PSA Cards to either print only the entries currently with Check Marks or to print all of the entries. Use the Check Mark command or the Mark Work Address for Printing - 1st (or 2nd) commands to mark entries for printing. If no entries are checked, the Print all entries button is automatically selected and both controls are disabled.

The name that is used in the address can be edited to include a title such as Mr. Fred Smith or Mr. and Mrs. Sam Jones. See the **Home Address** group in either the New Entry or Edit Current Entry commands.

Use the **Left** and **Top Margin** boxes to enter the position of the return address in inches. The top left corner of the To: address will be located relative to the top left corner of the return address. It will be 35% of the envelope width from the left edge of the return address and 45% of the envelope height below the top of the return address. So setting the correct envelope size is important. PSA Cards saves the envelope size and margins as part of the PSA Cards file.

Control the **Orientation** of the printed envelopes by clicking on **Portrait**; **Landscape, Top Left**; or **Landscape, Top Right**. Normally you should use landscape mode for printing envelopes on a laser printer. The **Landscape, Top Left** orientation is used for printers that feed envelopes with the flap to the extreme left of the special purpose tray and **Landscape, Top Right** is for printers that feed envelopes with the flap to the extreme right of the special purpose tray. Check your printer documentation for its envelope orientation and how to feed envelopes. If your printer feeds envelopes in the center rather than to the left or right, you will have to adjust the top margin until the printing appears on the envelope in the correct location. In this case Preview mode will show the addresses in the wrong position relative to the envelope outline.

The envelope printing function was developed and tested using a Hewlett Packard Laser Jet 4 printer. In spite of Microsoft's efforts to minimize printer differences through the Windows programming interface, other printers will exhibit their own idiosyncrasies. This means that getting the right margins and orientation for a particular printer and envelope size may require some experimentation. If you experience difficulties printing envelopes, please contact PSA Software for assistance.

The **Return Address** area displays the current return address selection. If you want to edit the return address or select another one, click on the **Edit** button. This will bring up the Return Address dialog box.

The **Font** button can be used change the printer font. It affects the envelope font as well as the printed card, label font, and address book font, but not the screen font. The font selection becomes part of your PSA Cards file. Clicking the font button brings up the Font dialog Box.

When you choose the **OK** button in print preview mode, the main window will be replaced with a print preview window in which one or two envelopes will be displayed in their printed format. The [print preview toolbar](#) offers you options to view either one or two pages at a time; move back and forth through the file; zoom in and out of pages; and initiate a print job. If you choose the **OK** button in print mode, envelopes will be printed.

See Also:

[Printing Summary](#)

[Using Check Marks](#)

Return Address dialog box (Print menu)

Use this dialog box to enter or edit up to four return addresses for envelopes. You can bring up this dialog box from the [Print menu](#) or the [Envelope dialog box](#) or the [Label Printing dialog box](#)



The image shows a dialog box titled "Return Address dialog box (Print menu)". It contains four radio buttons labeled "Address one", "Address two", "Address three", and "Address four". Each radio button is followed by a text box containing a return address. "Address one" is selected. At the bottom left, there is an "Omit" radio button. At the bottom right, there are three buttons: "OK", "Cancel", and "Help".

Address one	Address two
Fred Foo 1234 Baja Vista Fooville, CA 98500	Fred Foo Fanny Foo 1234 Baja Vista Fooville, CA 98500
Address three	Address four
Fanny Foo 1234 Baja Vista Fooville, CA 98500	Mr and Mrs. Fred Foo 1234 Baja Vista Fooville, CA 98600

Omit

To enter or edit a return address, click on the edit field, then type in your changes. To select a return address for printing, click on the radio button above the edit box you want to use. If you don't want any return address, click on the **Omit Return Address** button. The return addresses and the current selection state are saved as part of your PSA Cards file.

See Also:

[Printing Summary](#)

[Using Check Marks](#)

Print Preview - Labels command (Print menu)

This command is used to display a preview of what labels will look like when printed. This command brings up the Label Printing dialog box. Use this dialog box to control various aspects of label printing, including whether or not all entries or just selected entries are previewed or printed. To find out how to select entries for printing see the Check Mark command

See Also:

Printing Summary

Using Check Marks

Print Labels command (Print menu)

This command is used to print labels. This command brings up the [Label Printing dialog box](#). Use this dialog box to control various aspects of label printing, including whether or not all entries or just selected entries are previewed or printed. To find out how to select entries for printing see the [Check Mark](#) command

See Also:

[Printing Summary](#)

[Using Check Marks](#)

Print Labels Setup dialog box (Print menu)

This dialog box is used to control label printing and print preview for labels.

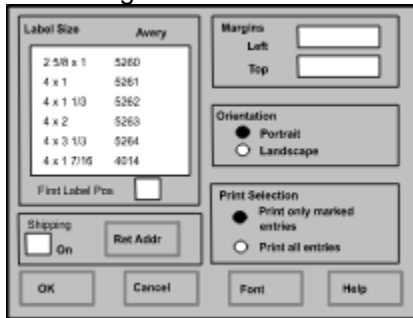

The controls in this dialog box are divided into groups for selecting the label size, setting margins, controlling what is printed, controlling the print orientation, and the OK, Font, Cancel, and Help buttons.

The **Label Size** list box can be used to select a variety of label sizes. The Avery label numbers are given on the right side of the list box. Some of the forms are for laser printers and some are for impact printers. The correct printer driver must be selected for the form type (laser or impact). Use the [Print Setup](#) command to select the printer driver.

The **First Label Position** edit box is used to put the first label on the first page somewhere other than the upper left corner. This is handy if you have a partially used sheet of peel-off labels and you want to start printing at the first unused label. The label positions are numbered from left to right and then down the page. Enter the number of the starting label position in the edit box. You can use print preview to verify that the first label will print in the correct position.

Use the **Shipping On** check box to print shipping labels. Shipping labels can be printed on Avery forms 5263, 5264, and 4161. The labels are printed with the word From: and then the return address at the top of the label and the word To: and destination address at the bottom of the label. The **Ret Addr** button can be used to edit and/or select a return address. This button brings up the [Return Address dialog box](#). Use the print preview to verify that the labels will be printed correctly.

Use the **Margin** controls to adjust the position of the printed labels. Enter the margins in inches. Separate margins for each label size are saved as part of your [PSA Cards file](#).

The **Print Selection** controls whether just the entries with [Check Marks](#) or all entries are printed. See the [Check Mark](#) command (Print menu). If no entries are checked, the Print all entries button is selected automatically and both controls are disabled.

Control the **Orientation** of the printed labels by clicking on Portrait or Landscape. Normally you should use portrait mode for printing labels.

The **Font** button can be used change the printer font. It affects the printed label font as well as the card font, envelope font, and address book font, but not the screen font. The font selection becomes part of your PSA Cards file. Clicking the font button brings up the [Font dialog Box](#).

When you choose the **OK** button in print preview mode, the main window will be replaced with a print preview window in which one or two pages will be displayed in their printed format. The [print preview toolbar](#) offers you options to view either one or two pages at a time; move back and forth through the card file; zoom in and out of pages; and initiate a print job. If an impact printer form and an impact printer are currently selected, the print preview window will also display the tractor perforations and the proper form width.

If you choose the **OK** button in print mode, labels will be printed.

See Also:

[Printing Summary](#)

[Using Check Marks](#)

Print Preview - Address Book command (Print menu)

This command is used to display a preview of what address books will look like when printed. This command brings up the [Address Book Printing dialog box](#). Use this dialog box to control various aspects of address book printing, including whether or not all entries or just selected entries are previewed or printed. To find out how to select entries for printing see the [Check Mark](#) command

See Also:

[Printing Summary](#)

[Using Check Marks](#)

Print Address Book command (Print menu)

This command is used to print address books. This command brings up the [Address Book Printing dialog box](#). Use this dialog box to control various aspects of address book printing, including whether or not all entries or just selected entries are previewed or printed. To find out how to select entries for printing see the [Check Mark](#) command

See Also:

[Printing Summary](#)

[Using Check Marks](#)

Print Address Book Setup dialog box (Print menu)

This dialog box is used to set up printing and print preview for address books.

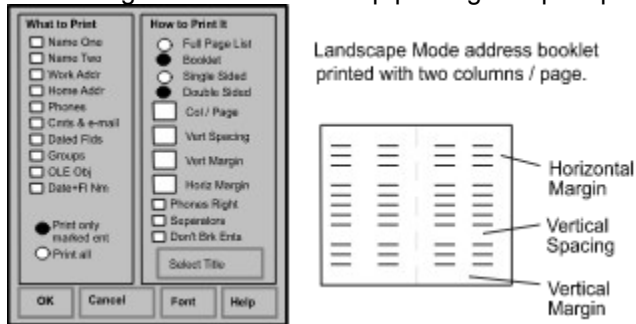

The controls in this dialog box are divided into groups for selecting what to print, how to print it, and the OK, Font, Cancel, and Help buttons. In the **What to Print** group you can select any part of your Card entries for printing. Checked items will be printed. Unchecked items will not be printed. These selections override those made in the Edit menu and the OLE menu. Check the **Date+File Name** box if you want the current date and file name printed at the bottom of each page along with the page number.

The **Print Selection** controls whether just the entries with Check Marks or all entries are printed. See the Check Mark command (Print menu). If no entries are checked, the Print all entries button is selected automatically and both controls are disabled.

In the **How to Print It** section selecting **Full Page List** will get you a 8.5 by 11 inch listing of your selections in portrait orientation. The **Booklet** selection makes an address booklet in landscape orientation. Booklet pages must be printed on both sides in a two pass operation. After printing, fold the pages in the middle and staple them in the center to make a 5.5 by 8.5 inch booklet.

The margins and vertical spacing are in inches. If the vertical spacing is set to zero, one blank line will be printed between entries with single spacing within entries. Larger vertical spacing will increase the space between sections within each entry and between entries. Overlap between columns is not checked by the program. Use the print preview command to see how each printed page will look and adjust the font, font size, horizontal margin, and number of columns to prevent overlap between columns. If you still get overlapping after adjusting the above items, it may be necessary to shorten items in the problem entries. If you are printing embedded objects (OLE items) it may be necessary to adjust their positions on the entries (open each problem entry in the main window and move the embedded object with the mouse) to achieve satisfactory results.

Checking the **Phones to the Right** box will cause the phone numbers to be moved up even with Name One and to the right side of each column of print. The maximum number of columns when using this feature is one. Using this feature also prevents entries from being broken at the bottom of a column.

Use the **Separator** check box to print a horizontal separator line between each entry. Checking the **Don't Break Entries** box will prevent dividing entries at the end of a print column.

If you are printing on both sides of the paper, the program will tell you how many sheets of paper to load in your printer. After all the sheets are printed on one side, feed them into the printer again so that the other side will print. Take care so that the top of the page will be at the same edge of the paper on both sides. The print operation does not pause where you need to turn the paper over and feed it in again. The program relies on the printer running out of paper at the end of the first pass.

The **Select Title** will bring up a dialog box where you can select an entry to use for a title on the first page. Entries are designated as possible titles in the New Entry or Edit Current Entry dialog boxes. Title entries are not printed as part of a normal selection of entries. Title pages can be designed using

Paintbrush or any other OLE Server program. To do this use the [Insert New Object](#) command in the [OLE](#) menu.

The **Font** button can be used change the printer font. It affects the printed address book fonts as well as the label fonts, card fonts, and envelope fonts, but not the screen font. The font selection becomes part of your [PSA Cards file](#). Clicking the font button brings up the [Font dialog Box](#).

When you choose the **OK** button in print preview mode, the main window will be replaced with a print preview window in which one or two pages will be displayed in their printed format. The [print preview toolbar](#) offers you options to view either one or two pages at a time; move back and forth through the card file; zoom in and out of pages; and initiate a print job.

If you choose the **OK** button in print mode, the address book or listing will be printed.

See Also:

[Printing Summary](#)

[Using Check Marks](#)

Select Title dialog box (Print Address Book Setup dialog box)

In the **Select Title** dialog box you can select an entry to use as a title on the first page of your address book. PSA Cards entries are designated as possible titles in the New Entry or Edit Current Entry dialog boxes. Title entries are not printed as part of a normal selection of entries. Title pages can be designed using Paintbrush or any other OLE Server program. To do this use the Insert New Object command in the OLE menu.

Clicking the **Set Default** button will give you a default title page that says: Addresses and Phone Numbers on it.

Choose Font dialog box (Print dialog boxes and Screen Font command)

Use this dialog box to select a printer font or screen font. When invoked from one of the print dialog boxes, the font selected here applies to printed cards, envelopes, labels and address books. The screen font is unaffected unless you got here using the Screen Font command. The printer font selection will become part of your PSA Cards file when you save it to disk. The screen font selection is saved in the cards.ini file.

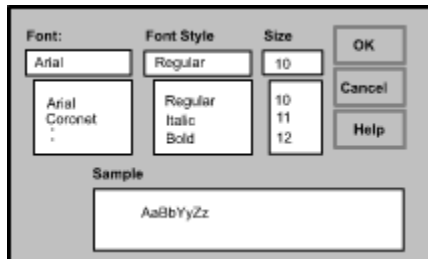

The Font dialog box is invoked from the Card Printing dialog box, the Envelope Printing dialog box, the Label Printing dialog box, and the Address Book Printing dialog box and the Screen Font command.

Print Setup command (Print menu)

Use this command to select a printer and a printer connection. This command presents a Print Setup dialog box, where you specify the printer and its connection.

See Also:

Printing Summary

Using Check Marks

Print Setup dialog box (Print menu)

This dialog box allows you to select the destination printer and its connection.

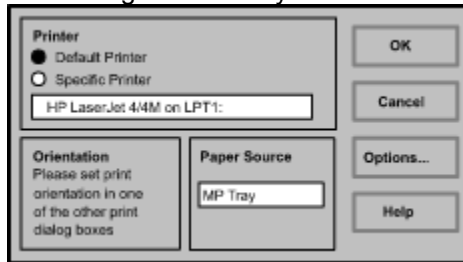

Printer

Select the printer you want to use. Choose the Default Printer; or choose the Specific Printer option and select one of the current installed printers shown in the box. You install printers and configure ports using the Windows Control Panel.

Orientation

In PSA Cards, the print orientation is set in the Print Setup dialog boxes for cards, envelopes, or labels. A separate print orientation setting is saved in the PSA Cards file for cards, envelopes, and labels.

Paper Size

Unlike the usual print dialog box, paper size is not set here. Select the card, envelope, or label size in the print card, print envelope, or print label dialog boxes. These dialog boxes are accessed from the Print menu.

Paper Source

Some printers offer multiple trays for different paper sources. Specify the tray here.

Options

Displays a dialog box where you can make additional choices about printing, specific to the type of printer you have selected.

Network...

Choose this button to connect to a network location, assigning it a new drive letter.

See Also:

[Printing Summary](#)

[Using Check Marks](#)

Print Progress Dialog (Print dialog boxes)

The Printing dialog box is shown during the time that PSA Cards is sending output to the printer. The page number indicates the progress of the printing.

To abort printing, choose Cancel.

Print Preview toolbar

The print preview toolbar offers you the following options:

Print

Start a print job.

Next Page

Preview the next printed page.

Prev Page

Preview the previous printed page.

One Page / Two Page

Preview one or two printed pages at a time.

Zoom In

Take a closer look at the printed page.

Zoom Out

Take a larger look at the printed page.

Close

Return from print preview to the editing window.

See Also:

[Printing Summary](#)

[Using Check Marks](#)

Locate command (Edit menu)

Use this command to find an entry with someone's name and to search for text strings or dates within entries. This command will bring up the [Search dialog box](#) with an alphabetical list of all the names in the [PSA Cards file](#). Select the name you want from the list and click the OK button. The entry containing the selected name will be opened. Double clicking on a name will close the dialog box and open the entry without clicking OK.

You can also search for someone by opening a divider tab and scanning entry names. See [Moving Around in the File](#) for more information.

Shortcuts

Keys: Ctrl+L

Toolbar:



Search Dialog Box (Edit Menu)



This dialog box is used to select the current entry and to search for text string or dates within entries. It comes up when you click on the Locate command in the edit menu. If no group is selected, all the names in the card file are listed alphabetically. You can use the scroll bar, page up, page down, arrow keys or mouse to select an entry. You can also type in the edit box and PSA Cards will attempt to find a matching entry. Double clicking on an entry name in the list box will close the dialog and display the entry without requiring you to click on **OK**. Clicking on the **Edit** button will bring up the Edit dialog box for the entry with the currently selected name.

If a group is selected, either by using the **Select Group** list box or by using the Show Only Cur Grp command in the Edit menu, only the members of the selected group will be listed. Clicking the **Deselect Group** button will cause all of the names to be listed in the left listbox. When you click **OK** and a group is selected, the current group will be changed to the selected group. The current group can also be set in the Edit Groups dialog box. If you click the **Deselect Group** button and then **OK**, and the Show Only Cur Grp command is in effect, the Show Only Cur Grp command will be unchecked (i.e. turned off).

If an entry has a second name entered or the name of a company is present in a work address, these names will also appear in the left listbox. You can further refine the search by clicking on the Search Other Fields button or on the Search Dates button. These buttons activate dialog boxes for searching any field for a text string or for finding dated information with a given date or using a range of dates.

After you click OK in the Search Other Fields dialog box, only the entries meeting the search criteria are listed here. You can then click on the **Set Check Marks** to set Check Marks on all the listed entries. When you first invoke this dialog box with the Locate command, the Search Other Fields search criteria are not used. That is, all entries are listed.

You can also search for someone by opening a divider tab and scanning entry names. See Moving Around in the File for more information.

Search Other Fields dialog box

This dialog box is used to find entries that have a given text string in various fields.

The dialog box contains the following elements:

- Find:** A text input field.
- In:** A list of fields with checkboxes:
 - First Name
 - Last Name
 - Home Addr
 - Business Addr
 - Dated Fid Txt
 - Comments
 - E-Mail
- If it:** A list of search criteria with radio buttons:
 - Contains
 - Matches Exactly
 - Starts With
 - Ends With
 - Sounds Like
 - Is Empty
 - Is Not Empty
- Match Case
- Set All** button
- Clear Sets** button

This dialog box is activated from the [Search](#) dialog box by clicking on its Search Other Fields button.

Enter the string you are looking for in the **Find:** edit box. Check the boxes on the left to indicate which fields you want searched. At least one of the **Home Address** or **Business Address** boxes must be checked before the **Street, City, State, or Zip** boxes are active.

The radio buttons on the right control how the string must match a field. **Matches Exactly** means the characters in the Find string must be the same as the search field. Whether or not the case must match is controlled for the first four radio buttons by the **Match Case** check box. Use the **Sounds Like** button to search for a word or name when you are uncertain of its exact spelling. Sounds Like will attempt to match the sound of the search string with words in the selected search targets. Because of the peculiarities of English spelling and pronunciation, Sounds Like doesn't guarantee correct matches in every case. If you use the **Is Empty** or **Is Not Empty** buttons, the Find string is ignored and a match is made solely on the basis of whether or not a string is empty.

Click on the **Select All** button to check all the field selection boxes and on the **Clear Sets** button to clear all the field selection boxes. When you click the **OK** button, this dialog box is closed and the names in the Search dialog box are reloaded. All the names for each entry that matches the search criteria are included. If you click the **Cancel** button in this dialog box, all the Search dialog box names are reloaded and the selections in this box are unchanged. That is, all the entry names are listed without regard to the search criteria and the selections previously present in this dialog box are undisturbed.

Search Dates dialog box

This dialog box is used to find dated fields on a given date or between two dates.

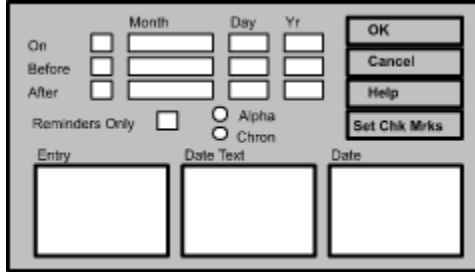

This dialog box is activated from the Search dialog box by clicking on its Search Dates button.

Use the **On**, **Before**, and **After** rows of boxes to control which dated information is shown in the Entry, Date Text, and Date list boxes. To activate a row of date boxes, click on its checkbox. If a date is recurring, its next anniversary is compared to the search dates. If a date is not recurring, its month, day, and year are used for comparison. Dates are designated as recurring or non-recurring in the Dated Fields dialog box. If the **Reminders Only** box is checked, only dated fields with alarms will be listed. If you have set search criteria in the Search Other Fields dialog box, only dated information that meets that criteria will be listed.

The **Alphabetically** and **Chronologically** radio buttons are used to control whether the dates will be listed alphabetically by entry name or chronologically by date.

If there are more entries than will fit in the list boxes, you can scroll the list boxes by selecting an entry with the mouse and then using the arrow keys to move the selection up and down.

Unlike the Search Other Fields dialog box, this dialog box does not affect which entries are listed in the main Search dialog box. For that reason, this dialog box has its own **Set Check Marks** button. Clicking on this button will set Check Marks for all of the entries in this dialog's Entry list box.

The **OK** button saves any changes you have made to the search controls in this dialog box and returns you to the main Search dialog box. The **Cancel** button just returns without saving anything.

Moving Around in the File and Selecting Entries

By Using the Mouse

To open the cards at a given divider tab, click on it. If there are entries at that divider, the first line of each entry will be displayed. The tabs are light green and the card entries are light yellow. To select a card and open it, click on it. The contents of the card will be displayed. This card is now "selected". To close a card or divider click on it again.

By Using the Keyboard

Dividers can also be opened by typing the letter key for the divider. If more than one divider starts with the same letter, typing the letter again will open the next divider with that letter. Lower case letters in the divider label are ignored. You can also open a divider by selecting it using the Tab key and then hitting the Enter key. When all the dividers are closed, the currently selected divider is drawn with a heavy black line over the divider label. To move the selection to the next divider, use the Tab key. To move backwards, use Shift+Tab. Ctrl+Tab will move to the last divider and Ctrl+Shift+Tab will move to the first divider. When selection is where you want it, hit enter and the divider will open.

When the divider is opened and there are entries at that divider, the first line of each entry will be displayed. The first card in the divider section will have a dotted line beneath its name. The dotted line means that the card is selected. To open that card hit Enter. To close the card hit Enter again. When the card is closed, the dotted line will come back. You can also move the card selection using the Tab, Shift and Ctrl keys. If a card is open and you hit the Tab key, the card will be closed and the next card will be selected (shown with the dotted line).

Mouse clicks and keyboard commands may be freely mixed while moving around and selecting entries.

When a card or divider is selected the, Forward and Back Toolbar buttons are enabled. When you click on these buttons, the current divider or card is deselected and either the next or previous divider or card is selected and opened. When a card is selected, the Check Mark commands, the Edit Cur Entry, and the Remove Cur Entry commands are also enabled.

If you double click on a card tab or the card itself, the card will be opened for editing. That is, the Edit Cur Entry dialog box will be displayed and the card will ready for editing.

You can also search for an entry using the Locate command.

Alarm dialog box (Displayed at program startup)

This dialog box is displayed when the program finds an alarm that you have set to remind you of a certain date. These dated fields are set up using the Dated Fields dialog box. If you click on the **Acknowledge** button, you will not be reminded again until the next anniversary of the alarm date occurs. If you click **Ignore**, the alarm will be triggered the next time the program is started up, provided of course, that the alarm date has not passed. If you want to reset an alarm, that you have acknowledged, use the Dated Fields dialog box to toggle the **Alarm** check-box on and off. This will restore the unacknowledged state.

Duplicate command (Edit menu)

This command duplicates the current entry and opens the Edit Entry dialog box. It is intended to be used in situations where you frequently create entries that have several identical fields. You can set up a template entry that has the identical fields filled in. Use the Duplicate command to make a copy of the template and open the Edit Entry dialog box. Then you can enter the information that is unique to the new entry.

Shortcut

Keys: Alt+Shift+D

Edit Cur Divider command (Edit menu)

This command is used to modify the currently selected divider tab. When it is selected, the Divider dialog box comes up. Also see the New Divider and Remove Cur Divider commands.

New Divider command (Edit menu)

This command is used to create a new divider tab. When it is selected, the Divider dialog box comes up.

Divider dialog box (Edit menu)

This dialog box is used to enter text for divider tabs.



This dialog is used to modify an existing divider tab or to create a new one. The **Divider Text** appears on the divider tab. The **Sort String** is used to determine the order of the divider tab in the PSA Cards file.

The default Sort String for the A divider tab is a blank (space) character. This is done because the blank is the first character in the ASCII collating sequence. Using a blank for the A divider tab ensures that it will come before any other entry. If you manage to get an entry that sorts before the first divider tab, it will not be visible.

Remove Cur Entry command (Edit menu)

Use this command to delete the currently selected entry. If no entries are selected, this command is disabled. To find out more about selecting entries see [Moving around in the file and selecting entries](#).

Remove Cur Divider command (Edit menu)

This command is used to delete the currently selected divider tab.

Remove CMark Entries (Edit menu)

This command deletes all entries with Check Marks. You can use this command to save a subset of your entries in a separate file. First select the entries you want to save by Check Marking them. Then use the [Toggle CMarks](#) command to reverse all the Check Marks, and remove the Check Marked entries with this command. Then you can save the remaining entries to a new file. Be sure not to update your existing file at this point, because that would make all the entry deletions permanent.

See Also: [Using Check Marks](#)

Edit Clipboard command (Edit menu)

Use this command to open the clipboard for editing. This command brings up the [Edit Clipboard](#) dialog box. This command is just one of a variety of ways you can use the clipboard in PSA Cards. See the [Clipboard Summary](#) for more information.

Shortcut:

Keys: Alt+Shift+C

Edit Clipboard dialog box (Edit menu)

This dialog box is used to display and edit the clipboard



Use this dialog to view and edit the current text contents of the clipboard. You can invoke it with the Clipboard command in the Edit menu. Only the text contents of the clipboard are shown. If the clipboard has non-text data in it and you click **OK - Update**, the clipboard will be cleared. You can use copy (Ctrl+Insert), cut (Shift+Delete), and paste (Shift+Insert) to change the text in the edit box. However, keep in mind that these operations themselves can change the content of the clipboard. So if you do use copy and cut while in this dialog, clicking **Cancel** will not restore the clipboard to its original state. It will just exit the dialog without further changes to the clipboard.

The clipboard can be used in a variety of ways in PSA Cards. Be sure to see the [Clipboard Summary](#)

Shortcut:

Keys: Alt+Shift+C

Clipboard Summary

The clipboard can be used several ways in PSA Cards:

Auto Load (See [Export](#) dialog)
Ctrl+Right Mouse Button
Ctrl+Left Mouse Button
Edit Clipboard command (See [Clipboard](#) dialog)
Shift+Delete
Shift+Insert
Ctrl+Insert
Copy OLE Item (See [Copy Object](#) command)
Paste OLE Item (See [Paste Object](#) command)

The Auto Load feature can be used to copy preselected fields from an entry to the clipboard each time an entry is opened in the main window. Auto Load is controlled from the [Export](#) dialog.

You can use the control key and the left mouse button to click on a field in an [open entry](#) in the main window. The field that you click on will be copied to the clipboard. If you use the control key and the right mouse button, the field will be appended to the current clipboard text. Suppose you want to copy a name and address from an open entry to the clipboard so that you can paste them into a letter you're writing. Just Ctrl+Left click on the address. To confirm your selection, do Alt+Shift+C (the Edit Clipboard command) to view the clipboard contents. You should note that the Mouse Manager (usually located in the main program group) is sometimes set up to use Ctrl+Click for its own purposes. If PSA Cards seems to be ignoring Ctrl+Click input, check the Mouse Manager.

If you want look at or edit the contents of the clipboard, use the [Clipboard](#) command.

As in most Windows programs, the Shift+Delete keys will cut text that you have highlighted in an edit control and place it in the clipboard. The Control+Insert keys will copy highlighted text to the clipboard. The Shift+Insert keys paste the clipboard contents at an edit control's insertion point.

The Copy Object and Paste Object commands are used to copy and paste Object Linking and Embedding (OLE) items.

Using Groups

PSA Cards has extensive facilities for working with collections of your entries. These collections are called groups. There can be as many groups as you need and an entry can belong to one or more groups. You can create a group by giving it a unique name. Group names can include any printing character (including blanks) except commas. Use the Edit Groups command to create groups; and to add any entry to, or remove it from, any group. You can also create new groups; and add an entry to, or delete it from, any group while using the Groups property page. The Groups property page is part of the tabbed dialog for creating or editing an entry.

You can limit Locate searches to specific groups. You can limit the display of entries in the main PSA Cards window to members of a single group using the Show Only Cur Grp command. The Display Groups command will display or hide group information for open entries in the main window.

Entry Check Marks can be set for groups in the Edit Groups dialog. Check Marked entries can also be added to groups in the Edit Groups dialog.

Edit Groups command (Edit menu)

PSA Cards lets you organize your card entries in arbitrary groups. There can be as many groups as you need and each card may belong to one or more groups. Each group is identified by a unique name. Group names can include any printing character (including blanks) except commas. Use this command to create groups and to change which entries are included in each group of entries. Executing this command invokes the Edit Groups dialog box.

See Also: Using Groups

Shortcut:

Keys: Ctrl+G

Edit Groups dialog box (Edit menu)

This dialog box is used to edit card groups.

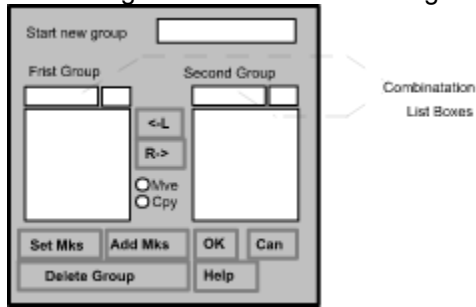

PSA Cards lets you organize your card entries in arbitrary groups. There can be as many groups as you need and each card may belong to one or more groups. Each group is identified by a unique name. Group names can include any printing character (including blanks) except commas. Groups are useful for separating the entries in your [PSA Cards file](#) into different lists. For instance one group could be a Christmas card list. Another list could be all the people in a club mailing list and so on. Once a group has been set up it can be used to control which entries are checked for printing rotary file cards, envelopes or mailing labels. Group membership can also be changed in the [Edit Current Entry's Group](#) dialog box.

To start a new group enter the name in the new group edit box and hit enter. The new group name will appear in the left combination list box and the left group list box. To add members to your new group, select the entry names from the right list box and click on the **L** button. To remove entries from a group, select the entry names in the left list box and click on the **R** button. The **L** and **R** buttons will move the selected entry names between the two list boxes. You can also double click on an entry in either list to move or copy it to the other list. The default for the right list box is all of the entries that are not in the group on the left. If you want to move or copy entries between two groups, select the second group using the right hand combination list box. If the left and right groups are different, you can use the **Copy** radio button to copy rather than move entries between the two groups.

The **Set Marks** button will set **Check Marks** for all of the entries in the left group. The **Add Marks** button will add all the entries with **Check Marks** to the left group. See the [Check Mark](#) command for more information about **Check Marks**.

To delete a group altogether select the group name to be deleted from the left combination list box and click the **Delete Group** button. This will delete the group and remove all references to it from every card entry. Card entries are not deleted by this operation -- only the group definition.

Changes made while in this list box are not applied to the PSA Cards entries until you click **OK**. Clicking the **Cancel** button will discard all the changes and close the dialog box.

See Also: [Using Groups](#)

Display Groups command (Edit menu)

Use this command to toggle the display of each entry's membership in groups. This affects both the screen display and printed versions of each entry that belongs to one or more groups. If group display is on, this command has a Check Mark. If it off, there is no Check Mark.

Show Only Cur Grp command (Edit menu)

Use this command to toggle the display of all entries in the file or just the entries in the currently selected group. You can change the currently selected using the Edit Groups command. When this command is checked, only entries in the currently selected group will be displayed in the main window.

OLE Summary

With the linking and embedding feature available in PSA Cards, you can include information, or objects created in other applications. Your PSA Cards entries can contain drawings, maps, sound clips, video clips, pictures, letters, graphs, and spreadsheets. You can embed copies of objects (**embedding**) or links to other objects in separate files (**linking**).

The main difference between linking and embedding is where the data is stored. Embedded objects become part of the [PSA Cards file](#). Linked information, on the other hand, remains in a separate source file. The PSA Cards file stores only the location of the information in the source file and displays a graphic representation of the linked data. A linked or embedded object can be represented in PSA Cards as either an icon or a picture of the object itself. Suppose you have written letters to a company called Ajax Inc. Then you forgot the path to those files. When you need to find the letters again, you can waste a lot of time looking for them on your hard drive. If you put a link to them in your PSA Cards entry for Ajax Inc., all you have to do is double click on the link icon in Ajax entry. The word processor that you used to write the letter is opened and the letter is loaded; ready for you to read or edit. If you only want to look at the letter, use the [Toggle Iconic](#) command to change the object's representation from an icon to a picture of the object. Use Toggle Iconic again to change it back.

Embedding means inserting information such as a scanned-in picture, drawing, map, chart, spreadsheet data, word processor document, sound clip, MIDI file, or video clip into a PSA Cards file. When you double click an embedded object in PSA Cards, you open the application in which the object was created; the object is displayed and ready for editing. When you return to PSA Cards, the PSA Cards entry reflects any changes you've made to the object. You can embed an existing object, file, or selection, or you can create and embed a new object.

Linking -- When you link a PSA Cards entry to another file, PSA Cards stores the link as a code that represents the source of the linked information. You can choose whether to store a graphic representation of the linked information or an icon in the PSA Cards entry.

In order to implement OLE, the PSA Cards file format was changed to what Microsoft calls a **Compound File**. Compound Files are slightly larger than their serial counterparts but offer the advantage of being easy to access and update selectively. What this means is that if you embed a large picture (bitmap) in a PSA Cards file, it is not read until it is displayed and is not written when the file is updated unless it has been changed. Selectively accessing and updating the file makes it possible to include large objects in the file without making the file access unacceptably slow. One of the disadvantages of compound files is that after many updates in which embedded objects are being added and deleted, the file will tend to become fragmented. That is, it will tend to have areas of unused disk space included in the file. To compact this unused disk space you should use the [Save As](#) command in File menu to copy the file to a new file name.

To find out about specific OLE commands in PSA Cards see the [OLE menu](#) or use the browse button (>>) to read the next several topics.

Hide OLE (OLE Menu)

If this menu item is checked, linked and embedded objects are not displayed or printed. The Address Book print setup has an explicit switch that overrides (but does not change) this setting.

Enable OLE Move/Resize (OLE Menu)

Linked or embedded objects (OLE items) can be moved or resized with the mouse. When you select an OLE item by clicking on it, it will be displayed with sizing handles. When the cursor is over a selected object, its shape changes to a four headed arrow to indicate that you can move the object by dragging it with mouse. If you put the cursor over a sizing handle, the cursor will change to a two headed arrow to indicate that you can drag the handle to change the size of the object. When you drag an object so that all or part of it is outside the card boundary, the card will be redrawn so that it continues to include the object. The redraw is done when the mouse button is released after dragging or resizing the object.

Since it is easy to modify an object when you don't intend to, **unchecking** this command will disable the move and resize functions. When move and resize are disabled, you are still able to select the object and activate or edit it.

If you switch the representation of the object between a picture (graphic representation) and an icon, and then change the object's size, the picture size and icon size will be stored separately. That is, two sizes are stored -- one for the picture and one for the icon. You can use the Toggle Iconic command to switch between icons and pictures.

Toggle Iconic

This command will change an iconic representation of an embedded or linked object to its graphic representation and vice versa. It is useful for embedded or linked documents, graphs, spreadsheets, and bitmaps. Since PSA Cards keeps separate sizes for iconic and graphic representations, you can set a large size for a OLE item's graphic representation and a much smaller size for its icon. When you just want to look at an OLE item without editing it, you can use this command to quickly display it without having to wait for its server application to load.

Shortcut: Ctrl+T

Copy Object (OLE Menu)

This command copies the currently selected object or object link to the clipboard. The previous contents of the clipboard are replaced. You can then use the Paste Object or Paste Object Link commands to paste the object into another card or even into another application. This command is disabled if an OLE item is not currently selected. This command applies only to OLE items. See the Clipboard Summary for more information about using the clipboard.

Shortcut:

Keys: Ctrl+C

Paste Object (OLE Menu)

Use this command to paste the contents of the clipboard into the current entry. Use the [Copy Object](#) command to copy an OLE item to the clipboard. This command is disabled until an OLE item is in the clipboard and a PSA Cards entry is open. After pasting you can use the [Toggle Iconic](#) command to change between an iconic and graphical representation of the object. The Paste Object command applies only to OLE items. See the [Clipboard Summary](#) for more information about using the clipboard.

Shortcut:

Keys: Ctrl+V

Paste Object Link command (OLE menu)

This command is used to paste link to an OLE item into the current card. See the [OLE Summary](#) topic for more information about OLE links. This command is disabled until the clipboard contains an OLE link and a PSA Cards entry is open. After pasting you can use the [Toggle Iconic](#) command to change between an iconic and graphical representation of the object. The Paste Object Link command applies only to OLE items. See the [Clipboard Summary](#) for more information about using the clipboard.

Delete Object (OLE Menu)

Use this command to delete the currently selected OLE item from the current entry. The Delete Object command does not ask for confirmation. It is disabled until an OLE item is selected.

Shortcut:

Keys

Del

Insert New Object command (OLE menu)

This command inserts an object, such as a chart or a drawing in the current entry. A PSA Cards entry must be selected before this command is enabled. When is command is clicked the Insert New Object dialog box is displayed. This dialog box lists the OLE servers available on your computer.

Insert New Object dialog box

The Insert New Object dialog box lists the OLE servers available on your computer. You can insert an object from a server by selecting the server from the Object Type list and clicking **OK**. The server application then becomes active -- either in its own window or a window in the current PSA Cards entry. If the server opens a window in PSA Cards, the PSA Cards menus will be merged with the server's menus. When you are done with the new object in the server, update the object and exit the server if the server is running in its own window. If the server opened a window in PSA Cards, click outside the server window or press the escape key. Card's menus should come back and normal PSA Cards operation can continue.

If you want to create a new object from an existing file, click the **Create from File** radio button. The dialog box will display an edit box for the name of the file, a **Browse** button and **Link** check box instead of the server list. Use the edit box and/or the browse button to indicate the file you want to use and click **OK**. If you check the **Link** check box, the object will be linked to the current PSA Cards entry rather than embedded in it. See [OLE Summary](#) for a description of the difference between linking and embedding.

If you want to display the new object or object link as an icon in the PSA Cards entry, check the **Display as Icon** box before creating the object or link. After inserting the object or link you can use the [Toggle Iconic](#) command to change between an iconic and graphical representation of the object.

Hint: It is well worth exploring the capabilities the OLE servers that are listed when you execute the Insert New command. You may be surprised at the things OLE can do -- even in a plain vanilla, out of the box Windows installation. At a minimum you should see Media Clip (for sound, video and MIDI), Paintbrush Picture and Package. You can also create Notepad and Write objects just by linking or embedding the file with the **Create from File** button.

WARNING One known serious OLE bug exists with PSA Cards and the Microsoft Word Equation Editor. Don't use the Equation Editor with PSA Cards. If you do, you may have to reboot your computer.

Links command (OLE menu)

Use this command to display a Links dialog box that lets you edit links between your PSA Cards entries and other documents.

This command is unavailable if you have no links in your PSA Cards file.

Links dialog box

Use the Links dialog box to edit links between your PSA Cards entries and other documents. Click on the link you want to change in the **Links** list box.

Source:

Displays the path and location of the source file.

Type:

Displays the application or type of application in which the linked object was created.

Update:

Specify how often you want to update the information.

Automatic -- Updates existing data every time new data becomes available.

Manual -- Updates existing data only when you choose the **Update Now** button.

Update Now

Updates all selected links in the Links Box.

Open Source

Opens the selected links in the Links Box.

Change Source

Specify a different source file for a selected link so that the link receives data from the source file.

Break Link

Breaks the link between the source file and the PSA Cards entry.

Object verb (OLE menu)

This command will change depending on the type of embedded or linked object that is currently selected. Typical commands that may appear here are **Play**, **Edit**, **Open**, or **Convert**. The **Play** command is typically used for sound, MIDI, or multimedia clips. The **Edit** and **Open** commands are used to change the object or its link. **Convert** brings up the Convert dialog box that is discussed below.

Shortcut

Mouse: Double-click the object with the left mouse button.

Change Icon dialog box

This help topic is inaccessible due to a problem with the OLE dialogs.

Convert dialog box

The Convert dialog box is accessed from the OLE menu Object verb. The Object verbs will change, depending on the type of object that is currently selected. Usually, the Object command will change to the name of the object type with a cascaded submenu showing the types of operations possible with the current object. One of these submenu items is **Convert**.

The **Object Type** listbox contains the name of the current object type as well as the possible types it could be converted to. The **Result** box shows what changes will take place with current dialog box settings. If **Convert To** is selected, the embedded object is converted to the type selected in the Object Type box. When the **Activate As** button is selected, the embedded object is opened as the type selected in the Object Type box, but returns the object to its original type after editing.

The **Display As Icon** checkbox is used to switch between iconic and graphical representations of the object or link. The **Change Icon** button can be used to change the icon and its caption. You can also use the Toggle Iconic command to switch between iconic and graphical representations.

If you switch the representation of the object between a picture (graphic representation) and an icon, and then change the object's size, the picture size and icon size will be stored separately. That is, two sizes are stored -- one for the picture and one for the icon.

Paste Special dialog box

This feature is not currently implemented.

Dial Number command (Dial menu)

The telephone dialing features of PSA Cards can be used to dial phone numbers from your [PSA Cards file](#). To use this feature, your computer must be equipped with a modem and a telephone. Normally the modem will be connected to the telephone line and the telephone connected to the modem:



Use this command to automatically dial a number from the currently selected card. If the other party answers the phone, the modem will automatically hang up in 15 seconds. This prevents leaving the modem off hook after you hang up the handset. The 15 second call time-out and several other autodial settings can be changed by using the [Dialing Setup](#) command.

If there is more than one number on the card and you use this command from the Dial menu, the Ctrl+D keys, or the Toolbar dial button, a [Phone Selection](#) dialog box will come up. Use it to select the number you want to call. Since there is no ambiguity when you select a number directly with a mouse shift-right-click, no dialog box comes up.

As PSA Cards dials the number, a call progress box is displayed. This shows the characters sent to the modem (dial string) and any messages (e.g., BUSY) returned by the modem. If the dialed number is busy, a [Redial Busy Number](#) dialog box will be displayed. Use this dialog box to request redialing the number.

To cancel a call in progress use the [End Call](#) command. Also, some modems will not connect the telephone set to the line until they go on hook. In such a case, the [End Call](#) command can be used to cause the modem to go on hook when the other party picks up the phone.

Shortcut

Keys: Ctrl+D
Mouse: Shift-right-click directly on the number in the card

Toolbar: 

End Call command (Dial menu)

Use this command to cause the modem to go on hook. That is, the modem will hang up. You can continue to talk. The call will terminate when you hang up the handset. If the computer is waiting to redial a busy number and you execute this command, the busy redial will be canceled.

Shortcut

Mouse: Click in the call progress box

Toolbar



Dialing Setup command (Dial menu)

This command brings up the Dialing Setup dialog box. Use this dialog box to set up local and long distance calls, enter a dialing prefix for an outside line, enter a modem initialization string, select the communications port, select the baud rate, set a call time-out value, and select tone or pulse dialing.

Dialing Setup dialog box (Dialing Setup command)

Setup Dial String			
Modem Init.	ATE1 F1		
<input type="checkbox"/> Use MI			
Outside Line			
Local Area Code			
Local Exchanges			
Local Cities			
	<input type="checkbox"/> Verify Changes		
	<input type="checkbox"/> Dial Local AC		
Port Control			
Com Port	Baud Rate	Call Timeout	
COM1	300	Sec	
COM2	1200	<input type="radio"/> Tone Dial	
COM3	2400	<input type="radio"/> Pulse Dial	
OK		Cancel	Help

Use this dialog box to set up automatic dialing. The **Modem Initialization** string can be used to send special initialization commands to your modem. It is turned off by default. If your modem is set to its default settings, you probably will not need to use this feature. The default initialization string that is shown above has commands to enable local command echo, set full duplex, set medium speaker volume, turn the speaker on, enable return on-line after commands, return verbal result codes, and enable all result codes.

Use the **Outside Line** edit box to enter a dial prefix string for an outside line. Use a comma to cause a two second delay while dialing.

The **Local Area Code**, **Local Exchanges**, and **Local Cities** fields are used to enter information about local phone numbers. When PSA Cards dials a phone number, it needs to know which numbers require a one to be dialed first and which numbers require an area code. Each number in the PSA Cards file has a flag that can be set using information from the above three fields and the **Do Setup** button. When you click on Do Setup, PSA Cards scans through all its phone numbers comparing their area codes to the Local Area Code. When it finds an area code that matches, it compares the first three digits of the phone number with the list of Local Exchanges. If the exchange is not in the list, it compares the City field of the card's home address to the Local Cities list. If either the city or exchange matches the local list, the number is considered to be a local call. If the **Dial Local AC** checkbox is checked, the local area code will be dialed for long distance calls within the local area code. If it is not checked, a one and the phone number will be dialed for long distance calls within the local area code.

To use **Do Setup** a **Local Area Code** and at least one of **Local Exchanges** and **Local Cities** must be supplied. Separate items in the lists with commas. Using a complete list of local exchanges is to be preferred over using a list of local cities because it will be more accurate.

The Local/Long distance flag can be set for individual numbers using the Edit Cur Entry command. Because the Do Setup button might change a Local/Long distance flag that has been set manually, the Verify Changes check box can be set so that PSA Cards will verify flag changes.

The **Do New AC** button brings up the New Area Code dialog box. This dialog is used when a new area code is added to an existing dialing area. Its purpose is to help automate changing the area codes in the affected phone numbers.

The **Port Control** section of this dialog box is used to select the **Com Port**, **Baud Rate**, **Call Time-out**, and **Tone Dial** or **Pulse Dial**. Except for Call Time-out, these selections are self explanatory. The default settings for these fields will usually be OK. Call Time-out (also see the Dial Number command) is the length of time the program will wait after dialing a number before putting the modem on hook, i.e., hanging up. This feature is provided so that the modem is not inadvertently left off hook after you hang

up the handset.

Local/Long Distance Verify dialog box (Dialing Setup command)

This dialog box comes up when the Verify Changes box is checked in the Dialing Setup dialog box and PSA Cards is about to change the Local/Long distance call flag for a telephone number. If you uncheck the Verify Changes box, this dialog box will not be displayed. The next time you run the Local/Long distance setup changes will be made without verification from you.

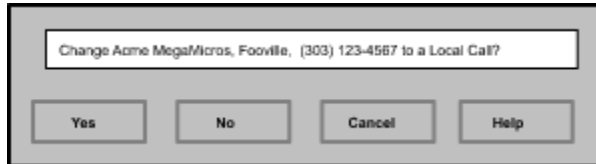

Yes button

If you click on the Yes button, the flag is changed immediately. Clicking the Cancel button in the Verify dialog box or in the Dialing Setup dialog box will not undo this change. You must use the Edit Cur Entry command (Edit menu) to edit a change made here.

No button

Clicking on No will not change the flag and will continue the scan of your PSA Cards file.

Cancel button

Clicking Cancel will exit back to the Dialing Setup box with no further changes to your PSA Cards file.

Help button

Clicking the Help button brings up this help topic.

New Area Code dialog box (Dialing Setup command)

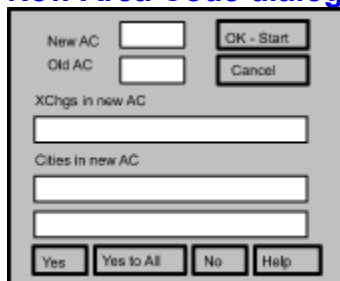

The dialog box is titled "New Area Code dialog box (Dialing Setup command)". It features a light gray background and a black border. At the top left, there are two input fields: "New AC" and "Old AC". To the right of these fields are two buttons: "OK - Start" and "Cancel". Below the "Old AC" field is a label "XChgs in new AC" followed by a single-line text input field. Below that is a label "Cities in new AC" followed by a two-line text input field. At the bottom of the dialog box, there are four buttons: "Yes", "Yes to All", "No", and "Help".

You can use this dialog box to change area codes that are affected by the addition of a new area code in an existing dialing area. Enter the new and old area codes in their fields. The exchanges (three digit prefixes) in the new area code can be entered from the list that is usually furnished by the phone company when they add a new area code. If the list of exchanges contains sequential numbers, the first and last numbers in a sequence can be separated by a dash (-). Other prefixes should be separated by commas. Thus the prefixes 214, 216, 220, 221, 222, 223, 224, 251, 260 would be entered as 214, 216, 220-224, 251, 260.

Because there may be several hundred prefixes affected by the addition of a new area code, there is a Cities in new area code field also. If you put a list of cities in this field (separated by commas), phone numbers in those cities will also be changed to the new area code.

When you click **OK - Start**, PSA Cards will check all the phone numbers with the old area code and exchanges or cities. As each one is found it will be displayed in the bottom field for verification. Click **Yes** if you want to change it. Clicking **Yes to All** tells the program to change all the rest of the matching phone numbers without further verification.

Phone Selection dialog box (Dial number command)

This dialog box comes up in response to the Dial Number command when there is more than one telephone number on a card.



Click on the number you want to dial a then click on **OK**. If you change your mind and don't want to make a call, click on **Cancel**

Redial Busy Number dialog box (Dial Number command)

This dialog box comes up when the dialed number (Dial Number command) is busy. If you want to keep trying, enter a redial time and click OK. Allow enough time for a dial tone to come back after the modem hangs up. If you want to cancel redialing later on, use the End Call command in the Dial menu,

or click on the cancel call button  in the toolbar, or click on the call progress box.

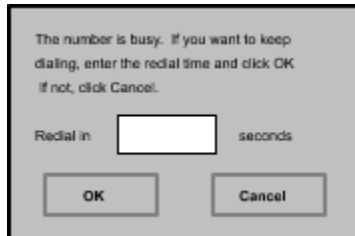

The number is busy. If you want to keep dialing, enter the redial time and click OK. If not, click Cancel.

Redial in: seconds

OK Cancel

Toolbar command (Preferences menu)

Use this command to display and hide the Toolbar, which includes buttons for some of the most common commands in PSA Cards, such as File Open. A Check Mark appears next to the menu item when the Toolbar is displayed.

See [Toolbar](#) for help on using the toolbar.

Toolbar



and

The toolbar is displayed across the top of the application window, below the menu bar. The toolbar provides quick mouse access to frequently used commands. The Windows NT or Windows 95 version of PSA Cards has a dockable toolbar. This means that you can drag the toolbar to left edge, right edge, or bottom of the Cards window and dock it there. You can also leave the toolbar floating either inside or outside of the PSA Cards window. PSA Cards remembers the location of the toolbar from one execution of the program to the next. The Windows NT and Windows 95 versions also have Tool Tips. When the cursor is moved over a toolbar button and briefly left there, a small yellow rectangle describing the function of the button is displayed.

To hide or display the Toolbar, choose Toolbar from the Preferences menu.

Click To



Open an existing PSA Cards file. PSA Cards displays the Open dialog box, in which you can locate and open the desired file.



Save the active card file with its current name. If you have not named the card file, PSA Cards displays the Save As dialog box.



Move to the next card if a card is currently open. Otherwise move to the next divider. This button is disabled if nothing is open. Also look at Moving around in the file and selecting entries.



Move to the previous card if a card is currently open. Otherwise move to the previous divider. This button is disabled if nothing is open.



Locate an entry with someone's name or search any field.



Edit the currently selected entry. This button is disabled if no entry is selected.



Set the Check Mark for the currently selected entry. This button is disabled if no entry is selected.



Dial a phone number from the current card. Click this to dial a phone number. This button is disabled if a no entry is selected. While a call is in progress this button is changed to the next button:



Cause the computer to hang up (go on hook). After the phone has started to ring, pick up your telephone handset and click on this button. The modem will hang up and you can begin your conversation when the other party answers.



Context sensitive help. Click this, then some interface object you wish to know more about.



Click here to exit PSA Cards.

Toolbar Forward Button



Use this button to move to the next card if a card is currently open. Otherwise it moves to the next divider. This button is disabled if nothing is open. If you are at the end of the file, PSA Cards moves to the beginning of the file. This command is not implemented in any menu.

Keyboard equivalent: Ctrl + F

See Also: [Moving around in the file and selecting entries.](#)

Toolbar Back Button



Use this button to move to the previous card if a card is currently open. Otherwise it moves to the previous divider. This button is disabled if nothing is open. If you move past the beginning of the file, PSA Cards goes to the end of the file. This command is not implemented in any menu.

Keyboard equivalent: Ctrl + B

See Also: [Moving around in the file and selecting entries.](#)

Toolbar Exit Button



Use this button to exit PSA Cards. This button is equivalent to the Exit command in the File menu.

Keyboard and Mouse Shortcuts

Keys	Menu - command	Action
Ctrl+O	File - <u>O</u> pen	Activates File Open dialog
Ctrl+S	File - <u>S</u> ave	Save current file
Ctrl+I	File - <u>I</u> mport	Imports an ASCII file
Ctrl+A	File - <u>E</u> xport	Export fields(s) to an ASCII File
Ctrl+M, RMB	Mark - <u>C</u> Mark	Sets an entry's <u>C</u> heck <u>M</u> ark
Ctrl+L	Edit - <u>L</u> ocate	Search for an entry, string, or date
Ctrl+E	Edit - <u>E</u> dit <u>C</u> ur <u>E</u> ntry	Edit the currently selected entry
Ctrl+N	Edit - <u>N</u> ew <u>E</u> ntry	Make a new entry
Ctrl+R	Edit - <u>R</u> emove <u>C</u> ur <u>E</u> ntry	Delete the currently selected entry
Ctrl+C	Edit - <u>C</u> opy <u>O</u> bject	Copy OLE item to clipboard
Ctrl+G	Edit - <u>E</u> dit <u>G</u> roups	Edit groups
Ctrl+V	OLE - <u>P</u> aste <u>O</u> bject <u>L</u> ink	Paste OLE item from clipboard to current entry
Del	OLE - <u>D</u> elete <u>O</u> bject	Delete current OLE item from entry
Ctrl+D, SRMB	Dial - <u>D</u> ial <u>N</u> umber	Dial phone number
Ctrl+F	Toolbar <u>F</u> orward	Move to next tab or entry
Ctrl+B	Toolbar <u>B</u> ack	Move to previous tab or entry
Ctrl+RMB	<u>C</u> opy a <u>F</u> ield	Copies a card field to the clipboard
Ctrl+LMB	<u>A</u> ppend a <u>F</u> ield	Appends a card field to the clipboard
Letter Key	See Notes	Opens tab with Letter in its label
Alt+Letter	See Notes	Menu, command, or DB control
Alt+Spacebar	<u>S</u> ystem	Open System Menu
Alt+Shift+C	<u>C</u> lipboard	Open clipboard
Alt+Shift+D	<u>D</u> uplicate	Duplicates current entry
Alt+Underlined Letter	See Notes	Activates a menu, command or control
Tab	Next	Move to next control in dialog box; <u>move to next card or divider</u>
Shift+Tab	Previous	Move to previous control; move to previous card or divider
Ctrl+Tab	Next Prop Sheet tab	Move to next tab in tabbed dialog; move to last card or divider
Ctrl+Shift+Tab	Prev Prop Sheet tab See Notes	Move to previous tab in tabbed dialog; move to first card or divider
Arrow keys, Page Up, Page Down	<u>S</u> croll <u>b</u> ars	Scroll main window

Notes:

RMB (Right Mouse Button) -- Click on an entry with the right mouse button to set its Check Mark.

SRMB (Shift Right Mouse Button) -- Hold down the shift key and right click on a phone number in an entry to dial it.

When the **Letter Key** for the divider tab is pressed, the first tab found (starting from the currently selected divider) with a label beginning with the letter key is opened. If more than one tab label starts with the same letter, keep pressing the letter key until you get to the tab you want. If there is no tab starting with the letter, the second letter of each tab is searched, and the third letter and so on until all the tab letters have been searched. If the letter is still not found, no action is taken. The letter in the tab label must be in upper case for a match. See Moving Around and Selecting Entries to find out more.

Keyboard Hints

When a menu name, menu item (command), or dialog box control has an underlined letter in its name, you can access it by typing the **Alt+Underlined Letter** combination. When the same underlined letter is used more than once in the same window, type the Alt+Letter combination again to move to the next control with that underlined letter. If the control is a checkbox, the check is also toggled on or off. If the control is a radio button, the button is also selected. If you want to move from one radio button to the previous or next radio button, use the arrow keys. When the underlined letter is used in more than one checkbox or radio button in the same window, typing the Alt+Letter combination will select the control but won't toggle it. In this case use the spacebar after the control has been selected. If you are using a dialog box and focus is not in an edit control, you generally do not have to use the Alt key to access a control with an underlined letter.

See the [Clipboard Summary](#) for more information about using the clipboard.

Status Bar command (Preferences menu)

Use this command to display and hide the Status Bar, which describes the action to be executed by the selected menu item or depressed toolbar button, and keyboard latch state. A Check Mark appears next to the menu item when the Status Bar is displayed.

See [Status Bar](#) for help on using the status bar.

Status Bar

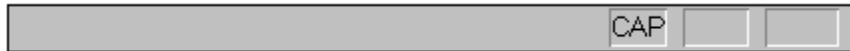

The status bar is displayed at the bottom of the PSA Cards window. To display or hide the status bar, use the Status Bar command in the Preferences menu.

The left area of the status bar describes actions of menu items as you use the arrow keys to navigate through menus. This area similarly shows messages that describe the actions of toolbar buttons as you depress them, before releasing them. If after viewing the description of the toolbar button command you wish not to execute the command, then release the mouse button while the pointer is off the toolbar button.

The right areas of the status bar indicate which of the following keys are latched down:

Indicator	Description
CAP	The Caps Lock key is latched down.
NUM	The Num Lock key is latched down.
SCRL	The Scroll Lock key is latched down.

Sounds command (Preferences menu)

This command toggles sound effects on and off. Sounds will be heard for most message boxes when this command is checked. The sounds are those assigned to system events in the Windows control panel. The Windows control panel is usually found in the Main program group in the Program Manager.

Screen Font command (Preferences menu)

Use this command to select a font for the screen. The font selection will be stored in the cards.ini file so that it will be recalled and used the next time PSA Cards is executed. This command brings up the Choose Font dialog box.

Street - PO Box Preferences commands (Preferences menu)

These commands are used control whether a PO Box or street address is used in addressing an envelope, mailing label, or exporting an address for mail merge. When an address is printed for an envelope, label, or exported for mail merge and neither field is empty, either the Post Office Box or Street address will be used. You can set which one you want with one of the Address Pref commands. If only one of the PO Box or street fields contains data, that field will be used regardless of the Address Pref setting.

Toolbar Button Size

These commands are used to change the size of the toolbar buttons. The smaller buttons will be most useful with smaller monitors and laptops. The button size selection is saved in the cards.ini file.

Address Selection cmds (Preferences menu)

These three commands are used to set your preference for the order in which address are selected when a Check Mark command is used. If a Check Marked entry has more than one address (possible addresses are: Home Address, Work Address 1, and Work Address 2) the program selects them in one of three orders when a Check Mark command is executed:

Main Address cmd	Home, Work 1, Work 2
Work Addr1 cmd	Work 1, Work 2, Home
Work Addr2 cmd	Work 2, Work 1, Home

For a given entry, the first address that is present in the selected order is used in print operations. If a work address is selected, the Check Mark symbol for the entry will contain the letters: W1 or W2.

Contents command (Help menu)

Use this command to display the opening screen of Help. From the opening screen, you can jump to step-by-step instructions for using PSA Cards and various types of reference information.

Once you open Help, you can click the Contents button whenever you want to return to the opening screen.

Using Help command (Help menu)

Use this command for instructions about using Help.

About command (Help menu)

Use this command to display the copyright notice and version number of your copy of PSA Cards. The name of the registered owner and the address of PSA Software are also displayed.

Register command (Help Menu)

This command is used to register your copy of PSA Cards with PSA Software. It brings up the Register dialog box.

Register dialog box (Register command)

Use this dialog box to register your copy of PSA Cards. To register, you enter your name and registration code in the Name and Registration Code edit boxes. To get a registration code, send \$25.00 (US), your name and address, and whether you are registering the Windows 3.1 or Windows NT version of PSA Cards to:

PSA Software
1319 Silk Oak Drive
Fort Collins, Colorado 80525-5597

Please make your check payable to William L. Rogers. You will receive a registration code by return mail. Be sure to enter your name and registration code **exactly** as shown on your registration. If you are entering the registration code using the numeric keypad, make sure that the num-lock light is on. Once the correct name and registration code have been entered, the **OK** button in this dialog box will be enabled. Click on it and your registration will be completed. Be sure to keep your registration code in case you need to re-register. PSA Cards will not display it. After registering, your name will be displayed as the registered owner in the [About](#) dialogbox. Registered copies of PSA Cards are enabled to make an unlimited number of updates to [PSA Cards files](#). Unregistered Copies of PSA Cards can only make 20 file updates.

What you get when you register:

- Registration code to fully enable PSA Cards file updates (Save command).
- Notification of new PSA Cards releases.
- Upgrades either free or at a reduced rate.
- Program support
- A personalized program diskette containing the latest version of PSA Cards.

There is a registration form and instructions in the text file REGISTER.TXT in the program directory. If you choose not to use the REGISTER.TXT file, *be sure to indicate whether or not you are registering the Windows 3.1 or Windows NT version* of PSA Cards so that we can send you the correct diskette.

If you are a **CompuServe** user, you can register on-line using CompuServe's on-line shareware registration service. Go to SWREG and enter registration ID 4619 to register the Windows 3.1 version of PSA Cards and ID 4620 to register the Windows NT version. Your PSA Cards registration code will be sent to you via CompuServe e-mail.

Unregistered Updates dialog box (Register command)

This dialog box comes up periodically when you update a file with an unregistered copy of PSA Cards. You will be allowed to save your file 20 times before registering your copy of PSA Cards. After 20 unregistered updates, you will still be able read your PSA Cards file but you will not be able to save any more changes until you register.

To find out how to register, see the Register command in the Help menu.

Context Help command



Use the Context Help command to obtain help on some portion of PSA Cards. When you choose the Toolbar's Context Help button, the mouse pointer will change to an arrow and question mark. Then click somewhere in the PSA Cards window, such as another Toolbar button, a menu command, or almost any other user interface object. The Help topic will be shown for the item you clicked.

Shortcut

Keys: Shift+F1

Title Bar

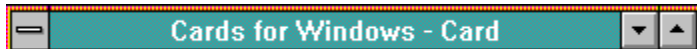

The title bar is located along the top of a window. It contains the name of the application and current PSA Cards file.

To move the window, drag the title bar. Note: You can also move dialog boxes by dragging their title bars.

A title bar may contain the following elements:

- Control-menu button



- Name of the application



- Name of the card file



- Maximize button



- Minimize button



- Restore button



Scroll bars



Scroll bars are displayed at the right and bottom edges of the main window. The scroll boxes inside the scroll bars indicate your vertical and horizontal location in the window. You can use the mouse to scroll to other parts of the window.

If you click on the up  or down

 arrows at the top or bottom of the vertical scroll bar, the card display will be moved up or down one line. Clicking in the scroll bar above or below the scroll button will move the card display up or down approximately one page. The page size is the same as the window size. Dragging the scroll button will move the card display up and down as you drag the button. The Horizontal scroll operation is similar to the vertical scroll bar. If the card display can be drawn entirely within the window, the scroll bars are not present.

You can also control scrolling with the keypad keys. The up and down arrows move the card display one line. The Page Up and Page Down keys move the display up and down one page. The Home and End keys move to the top and bottom respectively. The left and right keys will scroll to the left and right.

Size command (System menu)

Use this command to display a four-headed arrow so you can size the active window with the arrow keys.



After the pointer changes to the four-headed arrow:

1. Press one of the DIRECTION keys (left, right, up, or down arrow key) to move the pointer to the border you want to move.
2. Press a DIRECTION key to move the border.
3. Press ENTER when the window is the size you want.

Note: This command is unavailable if you maximize the window.

Shortcut

Mouse: Drag the size bars at the corners or edges of the window.

Move command (System menu)

Use this command to display a four-headed arrow so you can move the active window or dialog box with the arrow keys.



Note: This command is unavailable if you maximize the window.

Shortcut

Keys: Ctrl+F7

Minimize command (System menu)

Use this command to reduce the PSA Cards window to an icon.

Shortcut

Mouse: Click the minimize icon  on the Title bar.
Keys: Alt+F9

Maximize command (System menu)

Use this command to enlarge the active window to fill the available space.

Shortcut



Mouse: Click the maximize icon on the Title bar; or double-click the title bar.
Keys: Ctrl+F10 enlarges a window.

Close command (System menu)

Use this command to close the active window or dialog box.

Double-clicking a Control-menu box is the same as choosing the Close command.



Shortcuts

Keys: Alt+F4 closes the PSA Cards window or a dialog box.



Toolbar:

Restore command (System menu)

Use this command to return the active window to its size and position before you chose the Maximize or Minimize command.

Shortcut

Mouse: Click the restore icon  on the Title bar.

Switch To command (System menu)

Use this command to display a list of all open applications. Use this "Task List" to switch to or close an application on the list.

Shortcut

Keys: Ctrl+Esc

Dialog Box Options

When you choose the Switch To command, you will be presented with a dialog box with the following options:

Task List

Select the application you want to switch to or close.

Switch To

Makes the selected application active.

End Task

Closes the selected application.

Cancel

Closes the Task List box.

Cascade

Arranges open applications so they overlap and you can see each title bar. This option does not affect applications reduced to icons.

Tile

Arranges open applications into windows that do not overlap. This option does not affect applications reduced to icons.

Arrange Icons

Arranges the icons of all minimized applications across the bottom of the screen.

No Help Available

No help is available for this area of the window.

No Help Available

No help is available for this message box.

Divider tabs Also called Index tabs.
Used to separate alphabetically sorted sections of card entries. Click on one of these to open a divider section. Click again to close it. You can also open a divider by typing a letter in its label.

Entry tabs Click on one these to open an entry. Click again to close it. If it has a dotted underline, you can also open it with the Enter key.

Open Entry Shows data for an entry. Left click to close it, right click to set its Check Mark.

Object Linking and Embedding Item

Example of an embedded object -- in this case a map to Penelope's house.

Orientation can be either **portrait** or **landscape** and it controls how output is printed on the page:

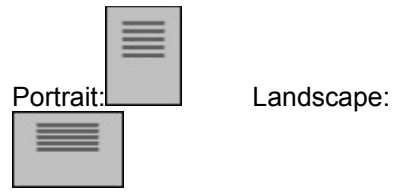

Imported phone numbers:

(303) 123-4567

or

303-123-4567

Envelope Title field is the first field in an address group or address dialog box. It will be printed as the first line(s) on an envelope, mailing label or mail merge export. It can have multiple lines.

Check Marks are used to flag entries for various operations. The most common use is to select entries for printing. Check Marks can also be used to form Groups, select entries for export, and flag entries as having been modified.

PSA Cards File is a specially formatted binary file used by PSA Cards to store information on a disk. It can only be read and written by PSA Cards. It contains your card entries and embedded (OLE) objects. Its file type is *.car.

Mail Merge is the process of producing form letters using a word processing program such as Microsoft's Word for Windows and a list of names and addresses.

Creating a New Entry

PSA Cards is designed for three different types of entries:

1. A residence with one or more individual's names, phone numbers, work addresses, and other information.
2. An Individual at a business with their name, phone numbers, business address, and other information.
3. A business with a contact's name, business phone numbers, business address, and other information.

To create a residence entry or to enter information for an individual at a business use the New Entry command. If you are entering data for an individual at a business, enter their business address using the Work Address tab. If there is a possibility that you will want to convert this type of entry to a business entry, enter the work address using the home address tab. Then when the entry is converted to a business the home address will appear as the business address. A residential entry has the name of the first person in the entry on its entry tab.

If you want to enter a business and have the entry listed by the company name, use the New Business command. If you also have a contact name at the company, use the Contact Name group of fields for that information. There is no provision for a home address for a contact name. A business entry will have the name of the business on its entry tab.

If you need to convert existing entries between business and residential types, the residential and business edit dialogs have buttons for that purpose. However, work addresses in a residential entry will be lost when a residential entry is converted to a business entry.

New Entry command (Edit menu)

Use this command to start a new entry in your PSA Cards file. This command brings up the [Edit Names tabbed dialog box](#). This dialog box is used to create new entries and edit existing entries. There are six property tabs (also known as pages or sheets) in this dialog box. Clicking on a tab in the program brings its property sheet to the front. Clicking on a tab in this help topic, jumps to the topic for the tab.



The property tabs for Names, Home Address, and Phones will have **Next** buttons on them. If you are entering a series of new cards, you can tab to the **Next** button and hit the Enter key to close the current card and start the next one. You can select tabs in the program by clicking on them or use the keyboard to move from tab to tab by pressing Ctrl+Tab. To move backwards through the tabs, press Ctrl+Shift+Tab.

The **Title Bar** contains the date and time that the current entry was last changed. This date and time is maintained separately for each card. It is affected by changes made in this dialog box, by changes made in the [Group Edit](#) dialog box, the [Dialing Setup](#) dialog box, and by changes made when [merging](#) two PSA Cards files. The Last Modified date can be used in [selecting cards to be printed](#) and in merging files.

Use this command for a residence or for an individual at a business when you want the individual's name to appear on the entry's tab.

See Also:

[Creating a New Entry](#)

Shortcut

Keys: Ctrl+N

New Business Entry command (Edit menu)

When you want to start a new entry for a business use this command. This command brings up the Edit Business Name tabbed dialog box. This dialog box is also used to edit existing business entries. There are five property tabs (also known as pages or sheets) in this dialog box. Clicking on a tab in the program brings its property sheet to the front. Clicking on a tab in this help topic, jumps to the topic for the tab.



The property tabs for Business Name, Business Address, and Phones will have **Next** buttons on them. If you are entering a series of new cards, you can tab to the **Next** button and hit the Enter key to close the current card and start the next one. You can select tabs in the program by clicking on them or use the keyboard to move from tab to tab by pressing Ctrl+Tab. To move backwards through the tabs, press Ctrl+Shift+Tab.

The **Title Bar** contains the date and time that the current entry was last changed. This date and time is maintained separately for each card. It is affected by changes made in this dialog box, by changes made in the Group Edit dialog box, the Dialing Setup dialog box, OLE operations, and by changes made when merging two PSA Cards files. The Last Modified date can be used in selecting cards to be Check Marked and in merging files.

See Also: Creating a New Entry

Edit Cur Entry command (Edit menu)

Use this command to edit the currently selected entry. This command brings up either the Edit Names tabbed dialog box or the Edit Business Name tabbed dialog box. These dialog boxes are used to create new entries and edit existing entries. There are either six or five property tabs (also known as pages or sheets) in these dialog boxes. Clicking on a tab in the program brings its property sheet to the front. Clicking on a tab in this help topic, jumps to the topic for the tab.

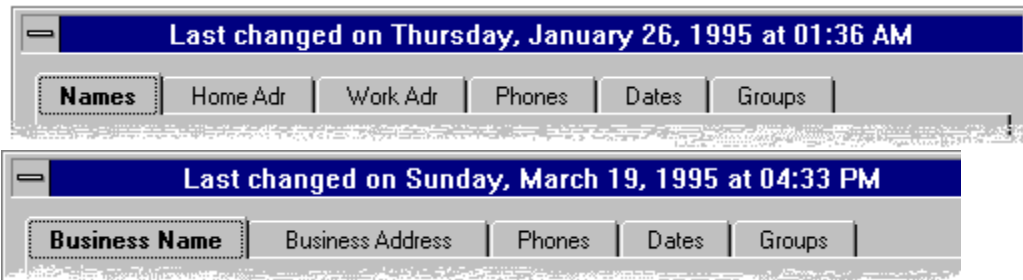

You can select tabs in the program by clicking on them or use the keyboard to move from tab to tab by pressing Ctrl+Tab. To move backwards through the tabs, press Ctrl+Shift+Tab.

The **Title Bar** contains the date and time that the current entry was last changed. This date and time is maintained separately for each card. It is affected by changes made in this dialog box, by changes made in the Group Edit dialog box, the Dialing Setup dialog box, OLE operations, and by changes made when merging two PSA Cards files. The Last Modified date can be used in selecting cards to be Check Marked and in merging files.

Shortcuts



Toolbar:

Keys: Ctrl+E

Mouse: Double click card or card tab

See Also:

Creating a New Entry

Names property tab (New & Edit Cur Entry Dialog boxes)

This property tab is for names in a residential entry.



When this property tab is being used to edit an existing entry, PSA Cards fills its fields with the contents of the currently selected entry. You can then click on a field to change its contents.

Name One is a special group of controls in this dialog box. Something must be present in either the First Name field or the Last Name field of this group. If both of these fields are cleared, you can only use the **Cancel** button to leave the Names property tab. The sort-string for the entry is made by concatenating the Last Name and the First Name. If you modify the First Name or Last Name fields so that the sort-string is changed, the entry's position in the card file may be changed when the **OK** button is clicked.

Name Two is for the second name of a person in the household or business.

You can change a residential entry to a business entry by clicking on the **->To Business** button. If a residential entry is used to list an individual at a business, and the business address is entered using the Work Address tab, and the entry is converted to a business type entry; the work address will be lost.

Use the **Additional information** box for stuff that doesn't go anywhere else.

The **E-Mail** field is for an e-mail address. This field is especially useful with the clipboard features.

If the **Address Book Title** box is checked, this entry can be used as the title page of an address book. Only text entered in the **Additional information** box is printed on the title page. Normally you would use the Insert New Object command in the OLE menu to create a title page using some other application such as Paintbrush or Microsoft Draw. You can define more than one address book title page. You select the one you want to use in the Address Book dialog box.

When this property tab is being used to make a new entry, it will have a **Next** button on it. If you are entering a series of new cards, you can tab to the **Next** button and hit the Enter key to close the current card and start the next one. You can select tabs by clicking on them or use the keyboard to move from tab to tab by pressing Ctrl+Tab. To move backwards through the tabs, press Ctrl+Shift+Tab.

See Also:

[Creating a New Entry](#)

[Moving around in the file and selecting entries](#)

Business Name property tab (New & Edit Cur Entry Dialog boxes)

This property tab is for a business name.



When this property tab is being used to edit an existing entry, PSA Cards fills its fields with the contents of the currently selected entry. You can then click on a field to change its contents.

Business Name is a special group of controls in this dialog box. Something must be present in either the Prefix field or the Business Name field of this group. If both of these fields are cleared, you can only use the **Cancel** button to leave the Names property tab. The sort-string for the entry is made by concatenating the Business Name and the Prefix. If you modify the Prefix or Business Name fields so that the sort-string is changed, the entry's position in the card file may be changed when the **OK** button is clicked.

If company name starts with an article (e.g., The Ultimate Acme Widget Co.), and you don't want the article to be used at the start of the sort-string, put the article in the **Prefix** field. This field is also handy if you have several entries for the same company, each at a different location, such as Denver, Fort Collins, and Loveland. If you put the location in the Prefix field, all the entries for the company will be together and will be sorted by location.

Contact Name is for the name of a person at the business. There is no provision for a home address for a contact name in this type of entry.

You can change a business entry to a residential entry by clicking on the **->To Residence** button.

Use the **Additional information** box for stuff that doesn't go anywhere else.

The **E-Mail** field is for an e-mail address. This field is especially useful with the clipboard features.

When this property tab is being used to make a new entry, it will have a **Next** button on it. If you are entering a series of new cards, you can tab to the **Next** button and hit the Enter key to close the current card and start the next one. You can select tabs by clicking on them or use the keyboard to move from tab to tab by pressing Ctrl+Tab. To move backwards through the tabs, press Ctrl+Shift+Tab.

See Also:

[Creating a New Entry](#)

[Moving around in the file and selecting entries](#)

Home Address property tab (New & Cur Entry dialog boxes)

Use this property tab to enter or edit a home address.

The image shows a dialog box titled "Home Address". It contains several input fields: a large text field at the top, a "Street" field, a "POB" field with a "Euro" checkbox, a "City" field, and "State" and "Zip" fields. A "Next" button is located to the right of the "City" field.

When this property tab is being used to edit an existing entry, PSA Cards fills its fields with the contents of the currently selected entry. You can then click on a field to change its contents.

Information in the **Title For Envelopes** field is be used for addressing envelopes, mailing labels, and export to a mail merge file. This field is automatically filled with the first person's name when the entry is created. When an address is used for mail merge, the program looks for titles in the first line of this field. If it finds a text string like Mr., Dr., or Mr. and Mrs., it will use that information to form a name for a letter's salutation like Mr. Jones, or Dr. Welby. You should add the appropriate title to this field.

The **PO Box** field and **Street** fields can both be filled in. When cards or address books are printed, both fields will be included. When an address is printed for an envelope, label, or exported for mail merge and neither field is empty, either the Post Office Box or Street address will be used. You can set which one you want with one of the Address Pref commands in the Preferences menu. If one of the fields is empty, the other will used regardless of the Address Pref setting.

The **Euro** checkbox is for European style postal codes. If this box is checked, the postal code (Zip) field will be included and printed before the city name rather than after the state.

When this property tab is being used to make a new entry, it will have a **Next** button on it. If you are entering a series of new cards, you can tab to the **Next** button and hit the Enter key to close the current card and start the next one. You can select tabs by clicking on them or use the keyboard to move from tab to tab by pressing Ctrl+Tab. To move backwards through the tabs, press Ctrl+Shift+Tab.

See Also:

[Creating a New Entry](#)

[Moving around in the file and selecting entries](#)

[Export command](#)

Business Address property tab (New & Cur Entry dialog boxes)

Use this property tab to enter or edit a business address.

The image shows a dialog box titled "Business Address". It contains several input fields: a large text box at the top, a "Street" label with a text box, a "POB" label with a text box and a "Euro" checkbox, a "City" label with a text box, and "State" and "Zip" labels with text boxes. A "Next" button is located to the right of the "City" field.

When this property tab is being used to edit an existing entry, PSA Cards fills its fields with the contents of the currently selected entry. You can then click on a field to change its contents.

Information in the **Title For Envelopes** field is used for addressing envelopes, mailing labels, and export to a mail merge file. This field is automatically filled with the contact name and business name when the entry is created. When an address is used for mail merge, the program looks for titles in the first line of this field. If it finds a text string like Mr. or Dr., it will use that information to form a name for a letter's salutation like Mr. Jones, or Dr. Welby. You should add a title to this field if appropriate. If you want something different here, click on the **Title For Envelopes** box and change it.

The **PO Box** field and **Street** fields can both be filled in. When cards or address books are printed, both fields will be included. When an address is printed for an envelope, label, or exported for mail merge and neither field is empty, either the Post Office Box or Street address will be used. You can set which one you want with one of the Address Pref commands in the Preferences menu. If one of the fields is empty, the other will be used regardless of the Address Pref setting.

The **Euro** checkbox is for European style postal codes. If this box is checked, the postal code (Zip) field will be displayed and printed before the city name rather than after the state.

When this property tab is being used to make a new entry, it will have a **Next** button on it. If you are entering a series of new cards, you can tab to the **Next** button and hit the Enter key to close the current card and start the next one. You can select tabs by clicking on them or use the keyboard to move from tab to tab by pressing Ctrl+Tab. To move backwards through the tabs, press Ctrl+Shift+Tab.

See Also:

[Creating a New Entry](#)

[Moving around in the file and selecting entries](#)

[Export command](#)

Work Address property tab (New & Edit Cur Entry dialog boxes)

Use this property tab to enter or edit a person's work address.

First Work Address		Second Work Address	
Name,	<input type="text"/>	<input type="text"/>	
Title	<input type="text"/>	<input type="text"/>	
Co.	<input type="text"/>	<input type="text"/>	
Street	<input type="text"/>	<input type="text"/>	
POB	<input type="text"/> <input type="checkbox"/> Euro	<input type="text"/> <input type="checkbox"/> Euro	
City	<input type="text"/>	<input type="text"/>	
State	<input type="text"/> Zip	<input type="text"/> Zip	

This property tab is used to enter the work addresses for an entry. The **Name, Title** fields are used for addressing envelopes, mailing labels and export to a [mail merge](#) file. When an address is used for mail merge, the program looks for titles in the first line of this field. If it finds a text string like Mr. or Dr., it will use that information to form a name for a letter's salutation like Mr. Jones, or Dr. Welby. You should add a title to this field if appropriate. The First Work Address fields are for the Name One person in the [Names property tab](#) and the Second Work Address fields are for the Name Two person.

The **PO Box** field and **Street** fields can both be filled in. When cards or address books are printed, both fields will be included. When an address is printed for an envelope, label, or exported for mail merge and neither field is empty, either the Post Office Box or Street address will be used. You can set which one you want with one of the Address Pref commands in the [Preferences](#) menu. If one of the fields is empty, the other will be used regardless of the Address Pref setting.

The **Euro** checkboxes are for European style postal codes. If these boxes are checked, the postal code (Zip) field will be displayed and printed before the city name rather than after the state.

You can select tabs by clicking on them or use the keyboard to move from tab to tab by pressing Ctrl+Tab. To move backwards through the tabs, press Ctrl+Shift+Tab.

See Also:

[Creating a New Entry](#)

[Export command](#)

Phones property tab (New & Edit Cur Entry dialog boxes)

Use this property tab for phone numbers.

Description	Area Code	Number
Home:	303	123-4567
Home:	303	123-4567
Office:	303	456-7123

This property tab is used to enter telephone numbers. Add as many phone numbers as you want. When the dialog box is first displayed, it is ready add the next phone number. Just start typing in the description field and then tab to enter the area code and number. To add another phone, click on the **New** button and enter a description, area code and number. The new numbers will be added to the list boxes as you type in each of the edit boxes. The **Description** field can be any descriptive text you want such as Office, FAX, or Mobile.

To change an existing phone number click on the entry you want to change. The selected number will be highlighted and copied to the top row of edit boxes. Click on the edit box you want to change and then edit it. Your changes will also appear in the list boxes as you type. The **Delete** button deletes the currently selected number.

The **Local** and **L. D.** buttons change the local/long distance flag for the currently selected entry. PSA Cards uses this flag when dialing phone numbers. See the [Dial menu](#) for more information about this feature.

When this property tab is being used to make a new entry, it will have a **Next** button on it. If you are entering a series of new cards, you can tab to the **Next** button and hit the Enter key to close the current card and start the next one. You can select tabs by clicking on them or use the keyboard to move from tab to tab by pressing Ctrl+Tab. To move backwards through the tabs, press Ctrl+Shift+Tab.

Dates property tab (New & Edit Cur Entry dialog boxes)

Use this property tab for dated information.



PSA Cards lets you enter dated information for each entry. This can be things like birthdays, anniversaries, and appointments. The text string associated with each date can be as long as you like, but both it and the date will appear on one line when a card is displayed on the screen or printed. Each entry can have as many dated fields as you need. The alarm field contains the number of days before the date to trigger the alarm. The alarm is turned on by selecting a dated field in one of the list boxes (it will appear in the top row of edit boxes when selected) and clicking on the **Alarm** button. Alarms are checked each time the program is started. When an alarm is triggered at program startup, PSA Cards reminds you of the date by displaying the Alarm dialog box.

The **Recurring Event** checkbox is to designate a date as recurring or non-recurring. A recurring event happens every year. This is the default for a new date. Whether or not a date is recurring affects whether or not alarms are reset after the date occurs and how dates are compared in the Search Dates dialog.

For a recurring date, the day of the week is not necessarily the day on which the date occurred or will occur. The displayed day of week is for the date on which the next anniversary of the date will occur. If you want to enter a date such as a birthday and do not know the year, or just don't want the year to appear, enter a zero (0) for the year. If the year is zero, PSA Cards will not use the year field when it displays or prints the date.

The **Delete** button deletes the currently selected dated field from the card. The **New** button is used to create a new dated field.

The **Check alarms** field set the frequency for checking reminders. Changing this value in any entry changes it for all entries. Alarms are checked each time the program is started and then as often as this field indicates. This field is useful for people who never turn their computers off and who leave PSA Cards running all the time.

You can select tabs by clicking on them or use the keyboard to move from tab to tab by pressing Ctrl+Tab. To move backwards through the tabs, press Ctrl+Shift+Tab.

Groups property tab (New & Edit Cur Entry dialog boxes)

Use this property tab to enter or edit group membership.



To start a new group type the name of the new group in the top edit box and hit **Tab**. The group name must be unique and cannot contain any commas. The new group name will appear in the right hand list box.

To add the current entry to an existing group, select the group name in right hand list box and click the **Add** button. To remove the current entry from an existing group, select the group name in the left list box and click on the **Remove** button. **Add** and **Remove** will move the selected group name (or names) from one list to the other. The same group name cannot appear in both lists at the same time. You can also edit groups with the Edit Groups command in the Edit menu.

You can select tabs by clicking on them or use the keyboard to move from tab to tab by pressing Ctrl+Tab. To move backwards through the tabs, press Ctrl+Shift+Tab.

See Also: Using Groups

sort-string is a text string used determine the order of your card entries. For example, the sort-string for Bill Rogers is RogersBill.

