

Install Audit & PD Options

■ **Trace Log**

- lists function calls, parameters, return codes

■ **Error Log**

- fatal and non-fatal errors
- records where in the install program the error occurred
- useful for CID, where unattended install messages would not be seen

■ **History Log**

- list of all files touched by the installation program



Install Audit & PD Options...

- **Detail Analysis File (CID only)**
 - Created only if CID ends in error
 - creates a ZIP file with the following:
 - ▶ History Log
 - ▶ Error Log
 - ▶ IBMLVL.INI
 - ▶ CONFIG.SYS
 - ▶ SQLSYSTEM



UPM Versions

- **DB2/2 requires & installs UPM v3**
- **E.S. v1 and LAN v2 install UPM v2**
- **Install order crucial:**
 - **DB2/2 after Extended Services**
 - **DB2/2 after LAN 2.0**

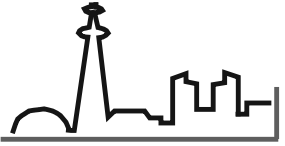

Investment Protection

Database Servers

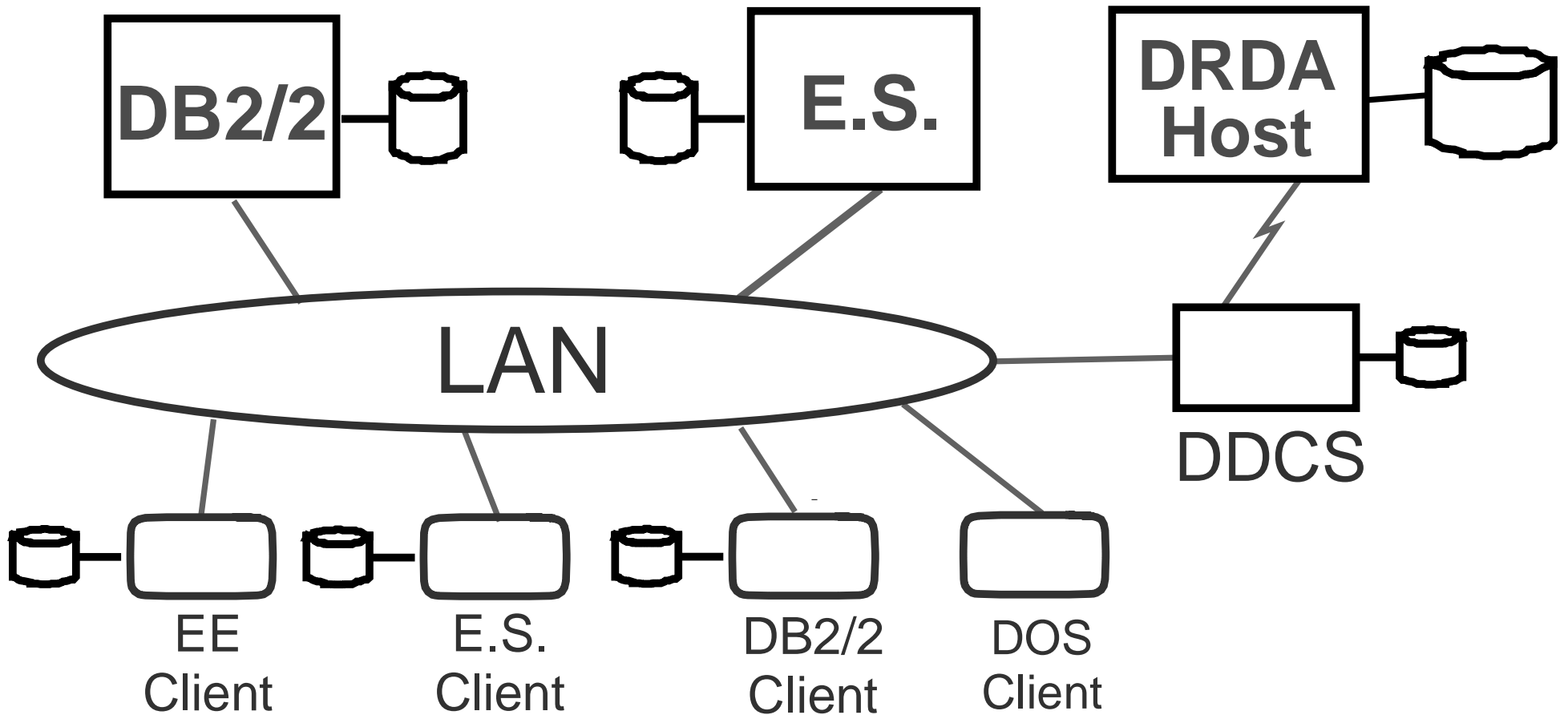

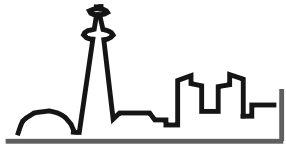

IBM NetBIOS Support

■ **OS/2 NetBIOS Support**

- IBM Network Transport Services/2 (NTS/2) v1
 - ▶ purchased separately or part of IBM LAN Server v3
- IBM LAN Adapter and Protocol Support (LAPS)
 - ▶ included in Extended Services v1, LAN Server v2, E.S. Distributed Client Features
 - ▶ not removed by DB2/2 Install if already present

■ **DOS NetBIOS Support**

- IBM LAN Support Program for DOS v1.2.1 or later

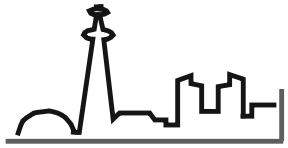

Database Migration

■ **Supported Migrations**

- IBM OS/2 Extended Edition v1.3
- IBM OS/2 Extended Services v1.0

■ **Migration method**

- API
 - ▶ SQLRC SQLEMIGD(database, spare1, sqlca)
- MIGRATE1 command
 - ▶ MIGRATE1 SALESDB
- Command Line Processor
 - ▶ DBM MIGRATE DATABASE SALESDB
- Query Manager

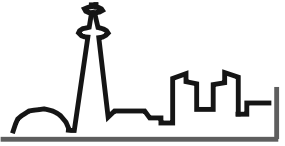

Forward Recovery Migration

INSTALL & MIGRATE

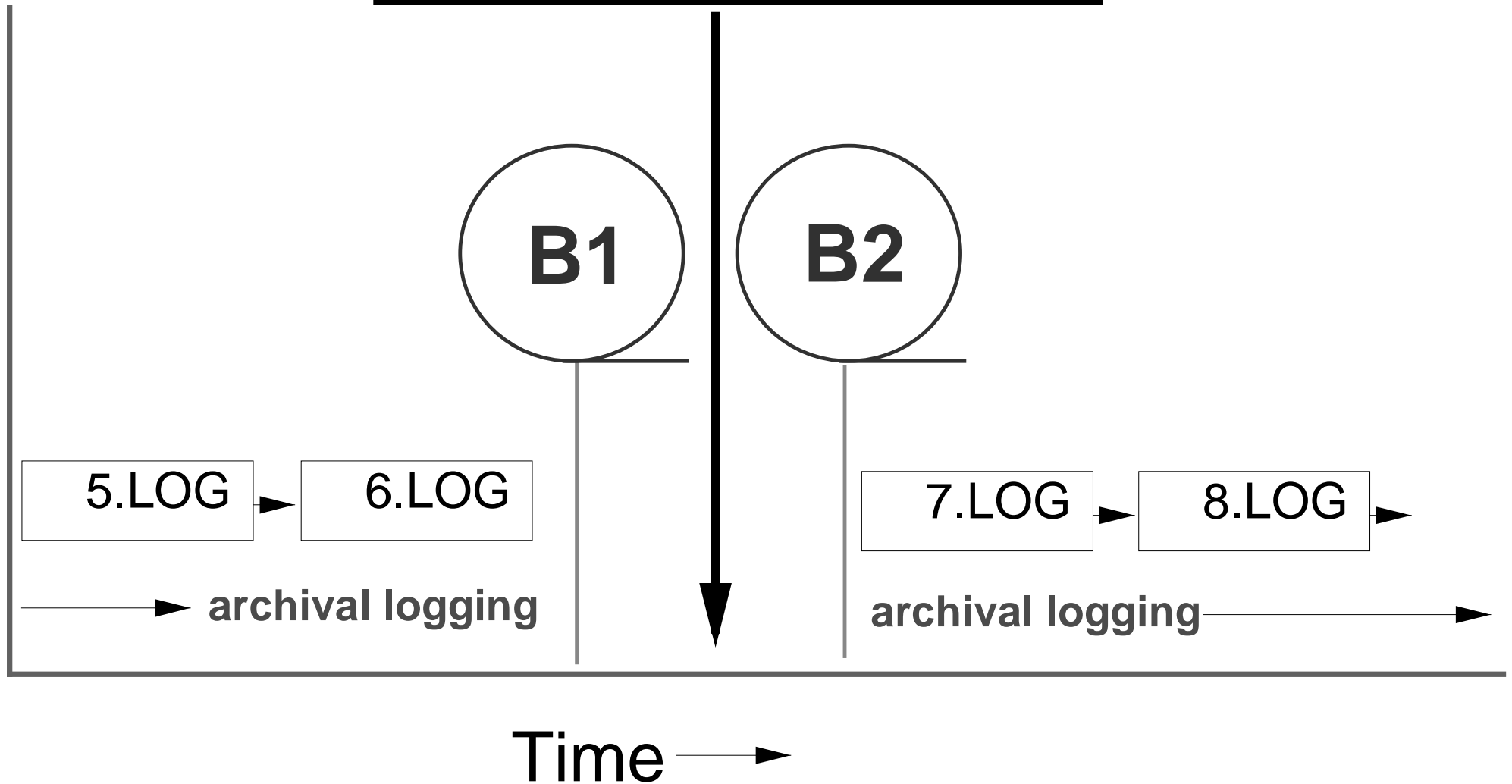

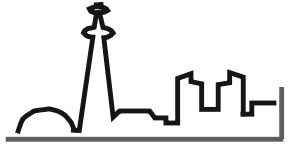

Existing Applications

- **No recompilation or relinking necessary**
- **re(BIND) suggested**
 - may improve performance with better access plan
- **All APIs identical**
 - No changes necessary



New DB2/2 Applications

- **C Set/2**
 - thinking support not needed for DB2/2
- **COBOL**
 - Micro Focus precompiler release level
- **FORTRAN**
 - entire new compiler
- **REXX**
 - no changes necessary

Pubs



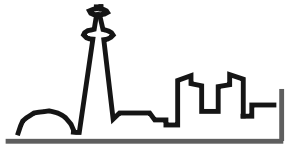

DB2/2 Publications

- **All pubs are in ship group!**
- **"Messages & PD Guide"**
 - maps SQLCODEs <-> SQLSTATEs
 - Reason Codes appendix
- **"DB2/2 Guide"**
 - incorporates "EE Parameter & Tuning Guide" DBM parameter explanations, benchmarking, sizing, and DBM file identification

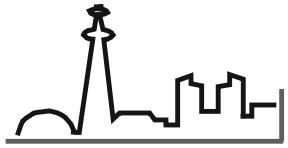

DB2/2 Publications...

■ **Color coded spines**

- Blue: Planning, Install, Administration
- Red: Programming Manuals
- Green: Reference Manuals
- Yellow: Master Index
- Purple: Query Manager

■ **Online**

- Help
- Command Reference
- Messages

IBM DATABASE 2 OS/2

Introducing DB2/2

DB2/2 Technical

Vendor News

Summary

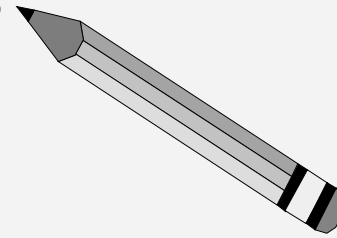

BRIDGE TECHNOLOGY INC.

BRIDGE/FASTLOAD for DB2/2

Robert B. Ashton

Bridge Technology Inc.
419 Boylston Street
Boston, MA 02116
617 424 6266
fax 617 424 6621

BRIDGE/FASTLOAD for DB2/2

- Loads Data Up to 8 Times Faster
 - Directly builds .DAT files
 - Bypasses "Database Engine"
- Flexible Input Sources
 - DB2/2 SQL Statement
 - Delimited or Non-Delimited Text

FASTLOAD PERFORMANCE

- 32 Bit Code
- Builds .DAT, .LF Files
- Uses DB2/2 to Build .INX Files
- No Logging
- Typical LOAD Speeds on 486-33 are 3 Meg/Minute
 - Compares with .5 Meg/Minute

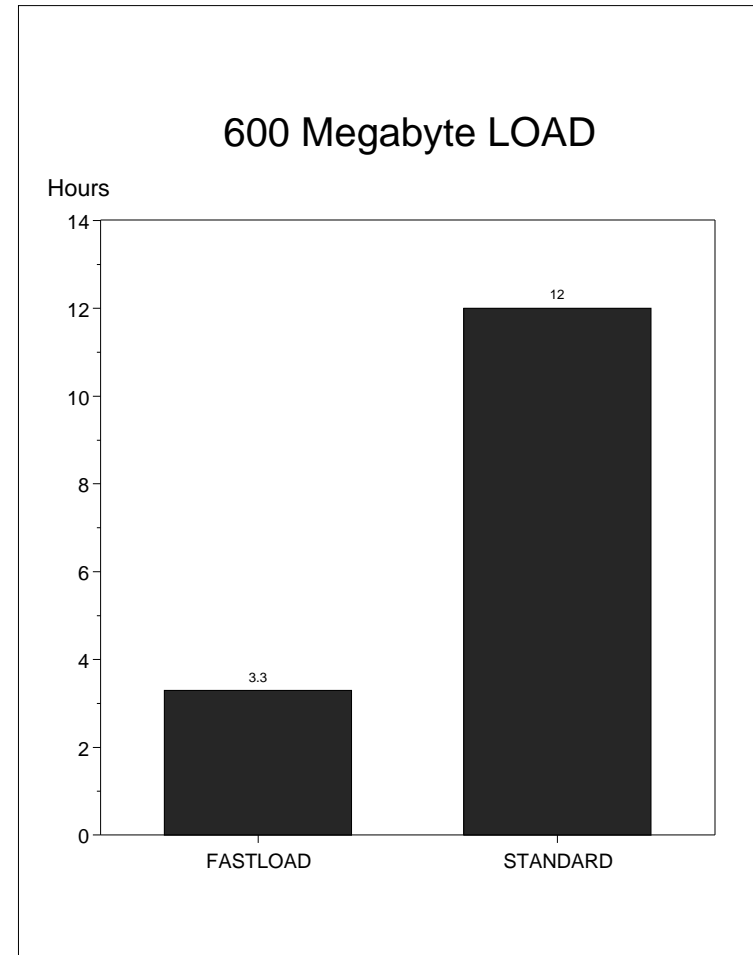

FASTLOAD Features

- Ability to Create .DAT Files Once and Install on Multiple Servers
- Strict/Relaxed Mode for Text Import
- Can Limit the Number of Rows
- Integrated with FASTLOAD for DB/2

BRIDGE/FASTLOAD for DB2/2 Product

- Single User Version
 - For Use with Standalone Version of DB2/2
 - \$99
- Multi-User Version
- For Use with Server Version of DB2/2
- \$999
- MVS Version
 - Generates .DAT Files on the Host
 - Works With Information Warehouse

DB2, VSAM, DL/1

Information Warehouse DB2

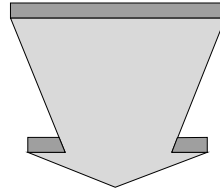

FASTLOAD for DB2



DB2/2 DAT File

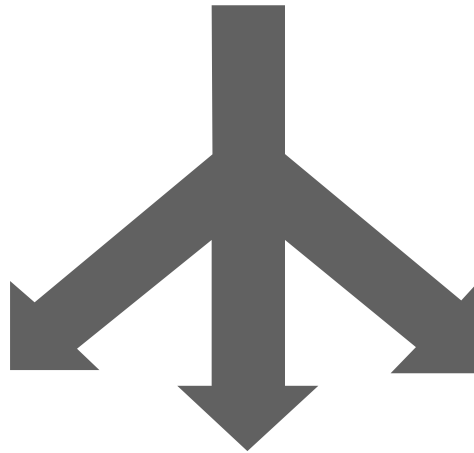

FASTLOAD for DB2/2

FASTLOAD Product Direction

- Datahub Support for DB2 to DB2/2 and DB2/2 to DB2/2 Copies
- Support for DB2 in the AIX Environment
- Ability to Generate INX Files Directly
- Further Speed Improvements

IBM DATABASE 2 OS/2

Introducing DB2/2
DB2/2 Technical
Vendor News
Summary

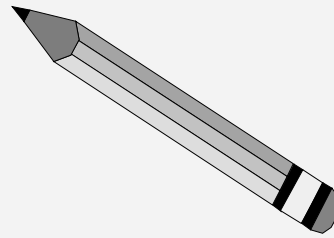



Continuing Evolution



**Leverage
IBM
Strengths**

- *Compatibility
- *Robustness
- *NLS
- *Quality
- *Service

**Accelerate
Technical
Leadership**

- *Capitalize on
Research
Investment
- *Performance

**World
Class
RDBMS**

- *Advanced
Parallel
- *Complex
Object
Support



You CAN Participate!

Customer:

**Participate in User Groups
Document the requirement
with the Account Team**

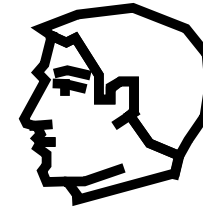

Account Team:

**Get Requirements Package from
TOROLAB3(DBMREQ)
Work with Customer to document
the requirements
Request Disclosure Meeting**

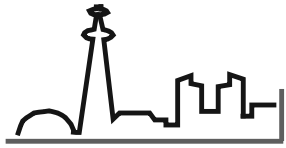

IBM DB2/2 & DDCS/2 Newsletter

- **Quarterly Newsletter**
- **Starts at General Availability of DB2/2**
- **Customer signup:**
 - Mail
 - Fax
 - IBM available via:
 - WORKDBM PACKAGE on Marketing Tools

**IBM Canada Ltd
Database Technology Planning
31/110/895/TOR
895 Don Mills Road
North York, Ontario
Canada M3C 1W3
FAX 416-448-2114**



We'll be back.....*again*

IBM DB2/2™