



# ROCKETLINX ES8508

*ES8508 | ES8508F | ES8508-XT | ES8508F-XT*



## User Guide



## **Copyright Notice**

Control and RocketLinx are trademarks of Control Corporation.

Microsoft and Windows are trademarks of Microsoft Corporation.

FireFox is a trademark of Mozilla Foundation.

PuTTY is a copyright of Simon Tatham.

Other product names mentioned herein may be trademarks and/or registered trademarks of their respective owners.

First Edition, September 12, 2013

Copyright © 2013. Control Corporation.

All Rights Reserved.

Control Corporation makes no representations or warranties with regard to the contents of this document or to the suitability of the Control product for any particular purpose. Specifications are subject to change without notice. Some software or features may not be available at the time of publication. Contact your reseller for current product information.

## **Federal Communications Commission (FCC) Statement**

This equipment has been tested and found to comply with the limits for a Class A digital device, pursuant to Part 15 of the FCC Rules. These limits are designed to provide reasonable protection against harmful interference when the equipment is operated in a commercial environment. This equipment generates, uses, and can radiate radio frequency energy and, if not installed and used in accordance with the instruction manual, may cause harmful interference to radio communications. Operation of this equipment in a residential area is likely to cause harmful interference in which case the user is required to correct the interference at his expense.

The user is cautioned that changes and modifications made to the equipment without approval of the manufacturer could void the user's authority to operate this equipment.

# Table of Contents

<b>Introduction</b> .....	<b>7</b>
<b>Hardware Installation</b> .....	<b>9</b>
<b>Connect the Power and Ground</b> .....	<b>9</b>
<b>Connect the Digital Input and Relay Outputs</b> .....	<b>10</b>
<b>Mount the ES8508</b> .....	<b>11</b>
<b>Connect the Ethernet Ports</b> .....	<b>12</b>
<b>Connect the Fiber Port (ES8508F)</b> .....	<b>13</b>
<b>LED Descriptions</b> .....	<b>14</b>
<b>Panel Layout</b> .....	<b>15</b>
<b>Reset Button</b> .....	<b>16</b>
<b>Using PortVision DX</b> .....	<b>17</b>
<b>NetVision</b> .....	<b>17</b>
<b>PortVision DX Overview</b> .....	<b>18</b>
<b>PortVision DX Requirements</b> .....	<b>18</b>
<b>Installing PortVision DX</b> .....	<b>19</b>
<b>Configuring the Network Settings</b> .....	<b>21</b>
<b>Checking the Firmware Version</b> .....	<b>24</b>
<b>Uploading the Latest Firmware or Bootloader</b> .....	<b>25</b>
<b>Configuring Multiple RocketLinux Switches Network Addresses</b> .....	<b>26</b>
<b>Uploading Firmware to Multiple ES8508 Switches</b> .....	<b>27</b>
<b>Adding a New Device in PortVision DX</b> .....	<b>28</b>
<b>Using Configuration Files</b> .....	<b>29</b>
Saving a Configuration File .....	29
Loading a Configuration File .....	29
<b>Using the LED Tracker</b> .....	<b>30</b>
<b>Customizing PortVision DX</b> .....	<b>31</b>
<b>Accessing RocketLinux Documentation from PortVision DX</b> .....	<b>32</b>
How to Download Documentation .....	32
How to Open Previously Downloaded Documents .....	33
<b>Configuration Using the Web User Interface</b> .....	<b>35</b>
<b>Configuration Overview</b> .....	<b>35</b>
Web User Interface .....	36
Secure Web User Interface.....	38
<b>Feature Overview</b> .....	<b>40</b>
<b>Basic Settings</b> .....	<b>49</b>
Switch Setting.....	49
Admin Password .....	50
IP Configuration .....	51
Time Setting.....	53
DHCP Server Configuration .....	56
DHCP Leased Entries .....	58
DHCP Relay Agent .....	59

Backup and Restore.....	61
Backup the Configuration - Local File Method .....	62
Restore the Configuration - Local Method.....	63
Backup the Configuration - TFTP Server Method .....	64
Start the TFTP Server.....	64
Disable the Windows Firewall .....	65
Create a Backup File.....	66
Restore the Configuration - TFTP Server Method .....	67
Firmware Upgrade .....	67
Upgrading Firmware (Local File).....	68
Upgrading Firmware (TFTP Server).....	69
Factory Defaults .....	69
System Reboot.....	69
<b>Port Configuration .....</b>	<b>70</b>
Port Control.....	70
Port Status .....	72
Rate Control.....	73
Port Trunking .....	74
Aggregation Setting .....	74
Aggregation Status.....	75
<b>Network Redundancy .....</b>	<b>76</b>
STP Configuration .....	77
STP Port Configuration.....	78
STP Information .....	79
MSTP Configuration.....	81
MSTP Port Configuration .....	83
MSTP Information.....	84
Redundant Ring .....	86
Redundant Ring Information .....	87
Loop Protection .....	88
<b>VLAN.....</b>	<b>89</b>
VLAN Port Configuration .....	90
VLAN Configuration.....	92
GVRP Configuration.....	95
VLAN Table .....	96
<b>Private VLAN.....</b>	<b>97</b>
PVLAN Configuration .....	97
PVLAN Port Configuration.....	98
PVLAN Information .....	99
<b>Traffic Prioritization .....</b>	<b>100</b>
QoS Setting .....	100
CoS-Queue Mapping.....	101
DSCP-Queue Mapping .....	102
<b>Multicast Filtering .....</b>	<b>103</b>
IGMP Snooping.....	104
IGMP Query.....	105
Unknown Multicast .....	105
GMRP Configuration .....	106
<b>SNMP .....</b>	<b>107</b>
SNMP Configuration .....	107
SNMP V3 Profile.....	108
SNMP Traps.....	109



<b>Security</b> .....	<b>110</b>
Port Security .....	110
IP Security.....	111
802.1x Configuration .....	112
802.1x Port Configuration .....	113
802.1x Port Status .....	115
<b>Warning</b> .....	<b>116</b>
Fault Relay.....	116
Event Selection .....	118
SysLog Configuration .....	119
SMTP Configuration.....	120
<b>Monitor and Diag</b> .....	<b>121</b>
MAC Address Table .....	121
Port Statistics .....	123
Port Mirroring.....	124
Event Log .....	125
Topology Discovery (LLDP).....	126
Ping Utility.....	127
<b>Device Front Panel</b> .....	<b>128</b>
<b>Save to Flash</b> .....	<b>129</b>
<b>Logout</b> .....	<b>129</b>
<b>Configuration Using the Command Line Interface (CLI)</b> .....	<b>131</b>
<b>Overview</b> .....	<b>131</b>
Using the Serial Console .....	132
Using a Telnet/SSH Console .....	133
Using PortVision DX (Telnet or SSH) .....	134
Telnet - Windows XP .....	135
SSH Client .....	136
<b>Command Line Interface Introduction</b> .....	<b>137</b>
User EXEC Mode .....	137
<b>Accessing the Options for a Command</b> .....	<b>138</b>
Privileged EXEC Mode .....	140
Global Configuration Mode .....	141
(Port) Interface Configuration .....	142
(VLAN) Interface Configuration .....	143
<b>Command Mode Summary</b> .....	<b>143</b>
<b>VTY Configuration Locked (Error Message)</b> .....	<b>144</b>
<b>Basic Settings (CLI)</b> .....	<b>146</b>
<b>Port Configuration (CLI)</b> .....	<b>152</b>
<b>Network Redundancy (CLI)</b> .....	<b>155</b>
<b>VLAN (CLI)</b> .....	<b>164</b>
<b>Private VLAN (CLI)</b> .....	<b>167</b>
<b>Traffic Prioritization (CLI)</b> .....	<b>171</b>
<b>Multicast Filtering (CLI)</b> .....	<b>174</b>
<b>SNMP (CLI)</b> .....	<b>177</b>
<b>Security (CLI)</b> .....	<b>178</b>
<b>Warnings (CLI)</b> .....	<b>180</b>
<b>Monitor and Diag (CLI)</b> .....	<b>183</b>
<b>Saving to Flash (CLI)</b> .....	<b>186</b>
<b>Logging Out (CLI)</b> .....	<b>186</b>
<b>Service (CLI)</b> .....	<b>186</b>

**Complete CLI List..... 187**  
    User EXEC Mode ..... 187  
    Privileged EXEC Mode ..... 188  
    Global Configuration Mode..... 193  
    Port Interface Configuration Mode..... 198  
    VLAN Interface Configuration Mode..... 200

**ModBus TCP /IP Support ..... 201**  
    Overview ..... 201  
    Modbus TCP/IP Function Codes ..... 202  
    Error Checking ..... 202  
    Exception Response ..... 202  
    Modbus TCP Register Table..... 203  
    CLI Commands for Modbus TCP/IP ..... 210

**Technical Support ..... 211**  
    Control Private MIB..... 211  
    Control Support ..... 211

# Introduction

The RocketLinx ES8508 Series are managed switches with eight Fast Ethernet ports with advanced Layer 2 management and security, and high system reliability for deployment in mission critical networking applications.

The ES8508 series includes these models:

- ES8508 with eight Fast Ethernet ports
- ES8508-XT with eight Fast Ethernet ports and an extended temperature range
- ES8508F with six Fast Ethernet and two fiber ports (Single-Mode or Multi-Mode)
- ES8508F-XT with six Fast Ethernet, two fiber ports (Single-Mode or Multi-Mode), and an extended temperature range

**Note:** *Unless information is specific to a particular model, the ES8508 series is referred to as simple the ES8508.*

The ES8508 includes the latest managed switch technologies to ensure reliable, high-bandwidth data communication in a wide variety of applications. These include a 32Gbps switch fabric for real-time non-blocking data transmission, redundant network topology support including: ring, RSTP and MSTP, and a high performance ARM9 processor with an embedded hardware watchdog timer to guarantee performance and system stability under the most extreme operating conditions.

The ES8508 is optimized for reliable operation in demanding industrial settings with features including a rugged IP31 grade aluminum housing, wide operating temperature range, redundant power inputs, and a high level of immunity to both electromagnetic interference and vibration with compliance to the EN50121-4 and IEC 61373 railway standards.

Detailed specifications are available on the Comtrol [web site](#).

You can refer to [Feature Overview](#) on Page 40 for web user interface features.



# Hardware Installation

You can use the following subsections to install the RocketLinx ES8508 Series:

- [Connect the Power and Ground](#)
- [Connect the Digital Input and Relay Outputs](#) on Page 10
- [Mount the ES8508](#) on Page 11
- [Connect the Ethernet Ports](#) on Page 12
- [Connect the Fiber Port \(ES8508F\)](#) on Page 13
- [LED Descriptions](#) on Page 14
- [Panel Layout](#) on Page 15
- [Reset Button](#) on Page 16

## Connect the Power and Ground

---

---

You can use the following procedure to connect power and the ground to the ES8508.

1. Connect the DC power inputs.
  - a. Insert positive and negative wires (12-24AWG) into the PW+ and PW- contacts.

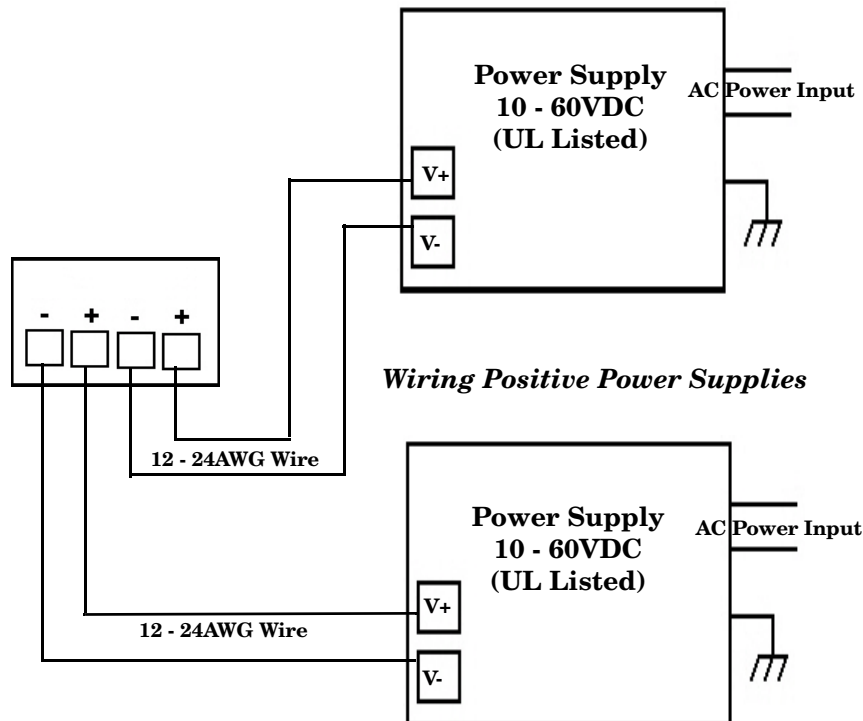

*Positive and negative power system inputs are both accepted, but PW1 and PW2 must be in the same mode.*

**Note:** Power should be disconnected from the power supply before connecting it to the switch. Otherwise, your screw driver blade can inadvertently short your terminal connections to the grounded enclosure.

- b. Tighten the wire-clamp screws to prevent the wires from coming loose.
  - PWR1 and PWR2 support power redundancy and reverse polarity protection.
  - If both power inputs are connected, the ES8508 is powered from the highest connected voltage.
  - The ES8508 can emit an alarm if PW1 or PW2 are no longer receiving power. See the [Warning](#) discussion on [Page 116](#) to configure an alarm.
2. Connect a ground wire between the chassis and earth ground using 12-24AWG wire to ensure that the ES8508 is not damaged by noise or electrical shock.
  - a. Loosen the earth ground screw on the bottom of the ES8508.
  - b. Insert the ground wire.
  - c. Tighten the ground screw after the earth ground wire is connected.

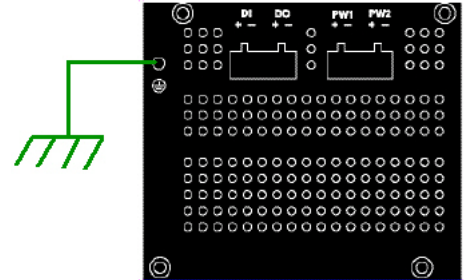

## Connect the Digital Input and Relay Outputs

The ES8508 provides one digital input and one digital output (dry relay output) on the terminal block connectors on the bottom of the unit. The fault conditions can be configured in the web user interface or Command Line Interface (CLI) and include:

- Power Failure
- Port Link
- Ring
- Ping
- Ping Reset
- Dry output
- DI

You can configure events using one of the ES8508 user interfaces ([Fault Relay](#) on Page 116) or the Command Line Interface ([Global Configuration Mode](#) on Page 141).

The Digital Input pin can be pulled high or low so that the connected equipment can actively drive these pins. The web user interface allows you to read and set the value to the connected device. The power input voltage of logic low is 0 to 10VDC and logic high is 11 to 30VDC. Do not apply a higher voltage than the specification; it may cause internal circuit damage or a cause an incorrect DI action.

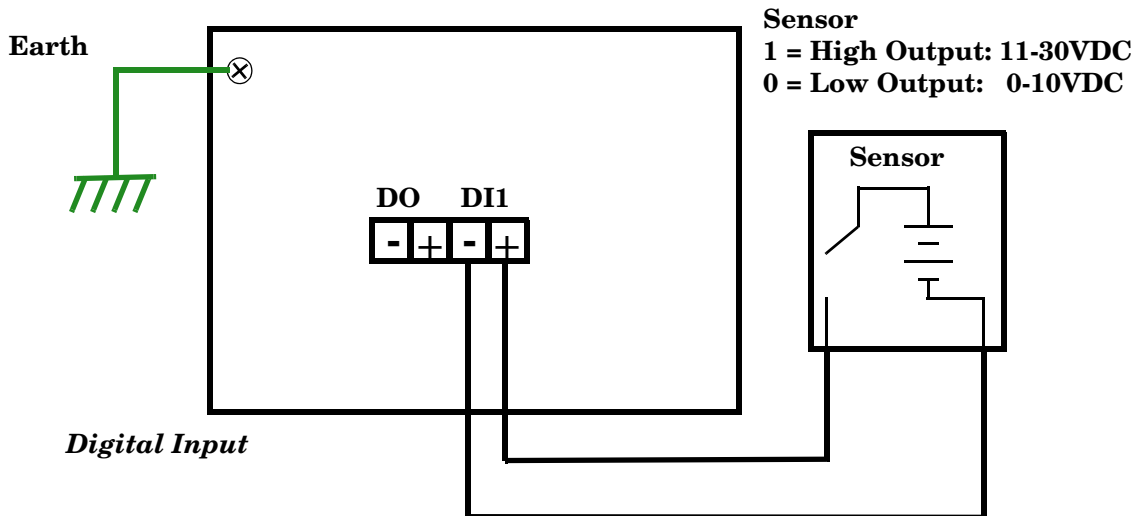

Digital output relay contacts are energized (open) for normal operation and close for fault conditions. The digital output relay contacts support up to 1A at 30VDC. Do not apply voltage and current higher than the specifications.

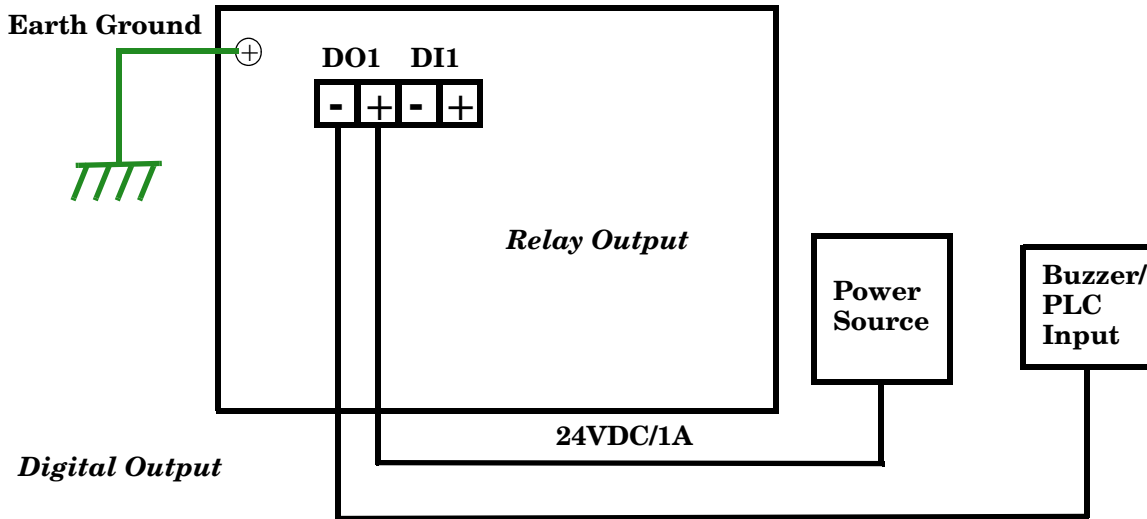

1. Insert the positive and negative wires (12-24 AWG) into V+ and V-.
2. Tighten the wire-clamp screws to prevent the wires from coming loose.

## Mount the ES8508

You can use the following procedure to mount the ES8508 on a DIN rail.

The DIN rail clip is already attached to the ES8508. If the DIN rail clip is not screwed onto the ES8508, follow the instructions and the figure below to attach DIN rail clip to the ES8508.

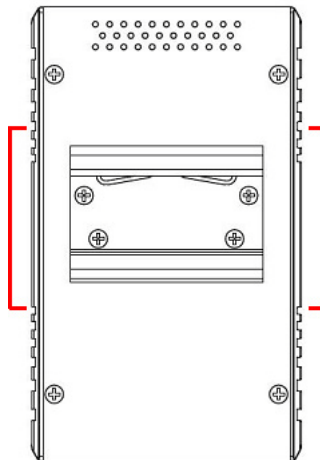

### DIN Rail Mounting

1. If necessary, use the screws to attach DIN rail clip to the rear panel of the ES8508. (To remove DIN rail clip, reverse Step 1.)
2. Insert the upper end of DIN rail clip into the back of DIN rail track from its upper side.
3. Lightly push the bottom of DIN rail clip into the track.
4. Verify that the DIN rail clip is tightly attached on the track.
5. To remove the ES8508 from the track, reverse the steps above.



## Connect the Ethernet Ports

You can use the following information to connect standard Ethernet cables between the ES8508 Ethernet ports and the network nodes.

- ES8508/ES8508-XT Ports 1 - 8 are Fast Ethernet ports (10/100BASE-TX)
- ES8508F/ES8508F-XT Ports 1 - 6 are Fast Ethernet ports (10/100BASE-TX) and Ports 7 - 8 are Fast Ethernet fiber ports (100BASE-FX, Single-Mode or Multi-Mode)

All of the Ethernet ports automatically detect the signal from the connected devices to negotiate the link speed and duplex mode (half- or full-duplex). Auto MDI/MDIX allows you to connect another switch, hub, or workstation without changing straight-through or crossover cables. Crossover cables cross-connect the transmit lines at each end to the received lines at the opposite end.

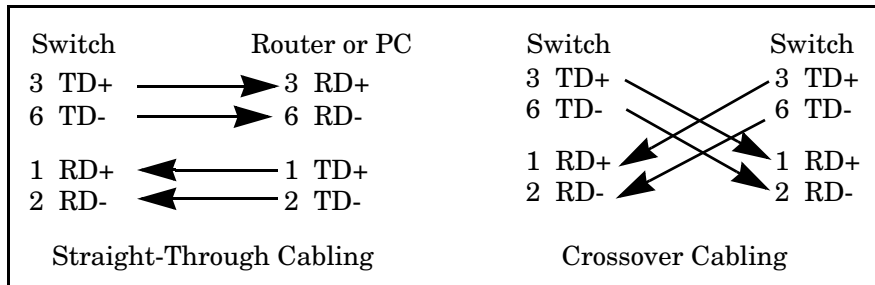

Connect one side of an Ethernet cable into any switch port and connect the other side to your attached device. The **LNK/ACT** LED is lit when the cable is correctly connected. Always make sure that the cables between the switches and attached devices (for example, switch, hub, or workstation) are less than 100 meters (328 feet) and meet these requirements.

- **10BASE-T:** Category 3, 4, or 5 cable
- **100BASE-TX:** Category 5 or 5e cable

Multi-Mode cables should not exceed 2KM and Single-Mode cables should not exceed 30km.

## Connect the Fiber Port (ES8508F)

Connect the fiber port to another fiber Ethernet device using the following diagram. An improper connection will cause the fiber port to not work properly. The fiber port is a standard or square connector (SC). Make sure that the fiber mode of the cable matches the fiber mode of the ES8508F (Single-Mode or Multi-Mode).

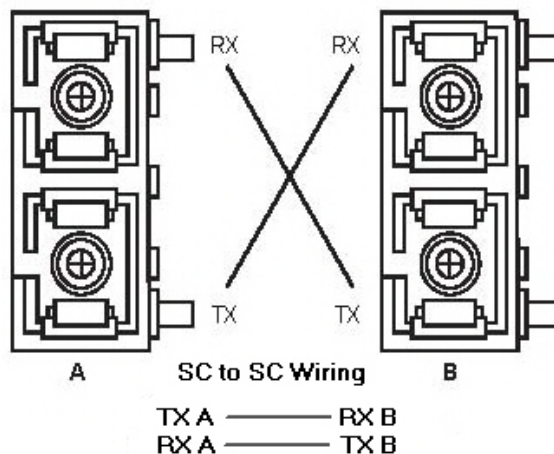

This is a Class 1 Laser/LED product.  
Do not stare into the Laser/LED beam.

The fiber connector is a standard connector or square connector (SC).

Mode	Cable Type	Wavelength	Transmit Power	Receive Sensitivity	Link Budget	Distance (km)
Multi	50/125um 62.5/125um	1310nm	-20dBm to -14dBm	-31dBm to 0dBm	11dBm	2km Note (below)
Single	8-10/125um	1310nm	-15dBm to -8dBm	-34dBm to -8dBm	19dBm	30km

**Note:** In the IEEE standard, it suggests the available transmission distance is 2KM for 62.5/125um fiber optical cable in 1310nm wave length. Actually, the attenuation of Multi-Mode 62.5/125um optical fiber cable is 1.5dBm/km and the maximum link distance can up to 4 to 5km.

IEEE organization recommends maximum optical fiber cable distances as defined in the following table.

Standard	Data Rate (Mbps)	Cable Type	IEEE Standard Distance
10BASE-FL	10	850nm, 50/125um or 62.5/125um Multi-Mode optical fiber cable	2km
100BASE-FX	100	1310nm, 50/125um or 62.5/125um Multi-Mode optical fiber cable	2km
100BASE-SX	100	850nm, 50/125um or 62.5/125um Multi-Mode optical fiber cable	300m

## LED Descriptions

---

---

This subsection provides information about the ES8508 LEDs. You can also refer to [Device Front Panel](#) on Page 128 for information about using the web user interface to remotely view LED information.

LED Name	LED On	LED Blinking	LED Off
SYS	Green: System ready	Green: Firmware loading	Power off
PWR1/2	Green: System power ready	Not applicable	System not ready
R.S. (Ring Status)	Green: Ring is normal Amber: Abnormal Ring	Green: Ring with the wrong port Amber: The device's ring port failed	Switch working in slave mode
DO1	Relay is active and contacts have been shorted	Not applicable	DO not activated
DI1	High digital signal is detected	Not applicable	DI not activated
LNK/ACT	Port is linked	Port active	Port link down or port not connected

## Panel Layout

The ES8508 and ES8508F support eight Fast Ethernet ports. Refer to the following illustrations for more information.

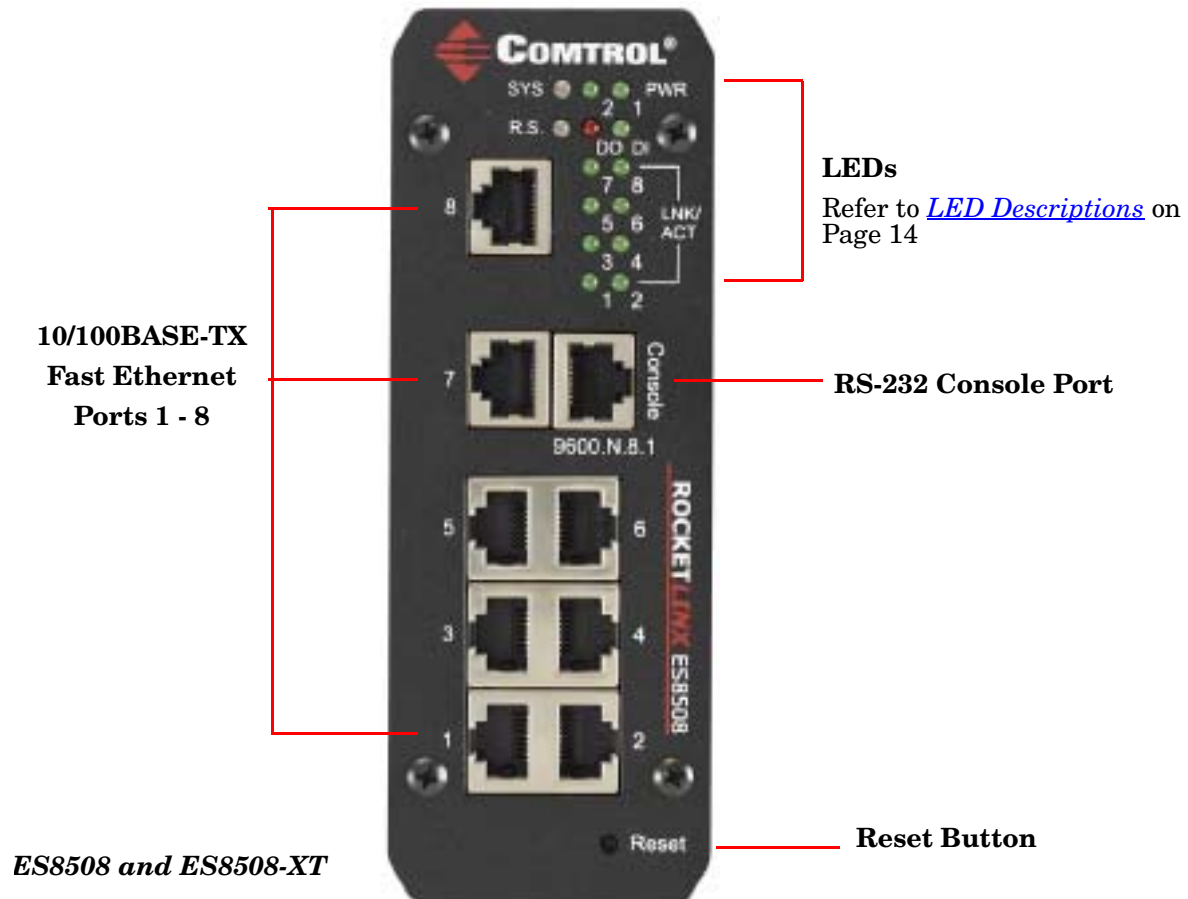

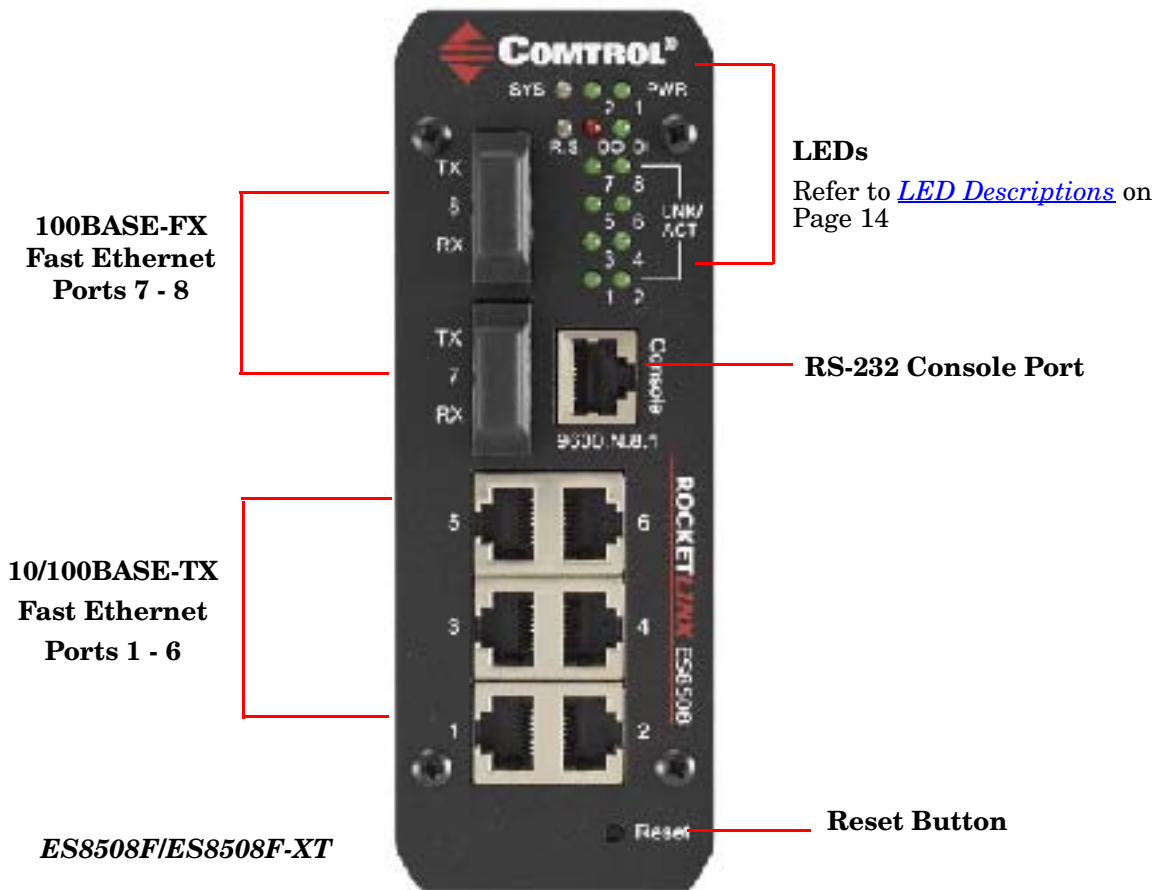

## Reset Button

The ES8508 has a reset button that you can use to reboot the ES8508 or reset the configuration to the factory default.

Reset Button	Description
Depress 5 Seconds	This reboots the ES8508 without changing the configuration.
Depress > 10 Seconds	This loads the factory default configuration values into the ES8508 including the IP address.

The **Reset** button is located on the front panel of the ES8508.

# Using PortVision DX

There are several ways to configure network information. Control Technical Support recommends connecting the ES8508 to a PC or laptop running Windows and installing *PortVision DX* for initial configuration.

This section shows how to use PortVision DX for initial network configuration and discusses how to:

- Install PortVision DX ([Page 19](#))
- Configure the network address ([Page 21](#))
- Check the firmware and bootloader version on the ES8508 to verify that the latest versions are loaded ([Page 24](#)) before configuration
- Download the latest version firmware and bootloader and upload it to the ES8508 ([Page 25](#))
- Perform other PortVision DX tasks, such as:
  - Configuring multiple ES8508 switches ([Page 26](#))
  - Uploading firmware to multiple ES8508 switches ([Page 27](#))
  - Adding a new RocketLinX (managed or unmanaged) or a third party device to PortVision DX to maintain device information on your network ([Page 28](#))
  - Using configuration files for use in configuring multiple installations with the same features ([Page 29](#))
  - Using the LED Tracker ([Page 30](#))
- Organize how PortVision DX displays your Control Ethernet attached products ([Page 29](#))
- Access the latest documentation for your Control Ethernet attached product

Optionally, you can use the web user interface or the CLI to perform these tasks on the ES8508 using these subsections:

- [IP Configuration](#) on Page 51
- [Firmware Upgrade](#) on Page 67
- [Basic Settings \(CLI\)](#) on Page 146

## NetVision

---

---

NetVision, the configuration utility that only supported RocketLinX has been replaced by PortVision DX, which supports all Control Ethernet attached products.

If you are familiar with NetVision and wish to use it, [NetVision](#) is still available but has been moved to *Legacy status*, meaning that it is no longer being maintained. If any bugs or issues exist, Technical Support will have you load and use PortVision DX.

## PortVision DX Overview

---

---

PortVision DX automatically detects Control Ethernet attached products physically attached to the local network segment so that you can configure the network address, upload firmware, and manage the following products:

- RocketLinx switches
- DeviceMaster family
  - DeviceMaster PRO
  - DeviceMaster RTS
  - DeviceMaster Serial Hub
  - DeviceMaster UP
  - DeviceMaster 500
- IO-Link Master

In addition to identifying Control Ethernet attached products, you can use PortVision DX to display any third-party switch and hardware that may be connected directly to those devices. All non-Control products and unmanaged RocketLinx switches are treated as non-intelligent devices and have limited feature support. For example, you cannot configure or update firmware on a third-party switch.

## PortVision DX Requirements

---

---

Use PortVision DX to identify, configure, update, and manage the ES8508 on the following Windows operating systems:

- Windows 8
- Windows Server 2012
- Windows 7
- Windows Server 2008
- Windows Vista
- Windows Server 2003
- Windows XP

PortVision DX requires that you connect the Control Ethernet attached product to the same network segment as the Windows host system if you want to be able to scan and locate it automatically during the configuration process.



## Installing PortVision DX

During initial configuration, PortVision DX automatically detects and identifies ES8508 switches, if they are in the same network segment.

Use the *Software and Documentation* CD that came with the ES8508 to check for the latest version of PortVision DX or use the link below to download the latest version.

1. Locate PortVision DX using one of the following methods to download the latest version:
  - **Software and Documentation CD:** You can use the CD menu system to check the version on the CD against the latest released version.
  - **FTP site subdirectory:**  
[ftp://ftp.control.com/rocketlinx/portvision\\_dx](ftp://ftp.control.com/rocketlinx/portvision_dx).

**Note:** Depending on your operating system, you may need to respond to a Security Warning to permit access.

2. Execute the `PortVision_DX[version].msi` file.
3. Click **Next** on the *Welcome* screen.
4. Click **I accept the terms in the License Agreement** and **Next**.
5. Click **Next** or optionally, browse to a different location and then click **Next**.

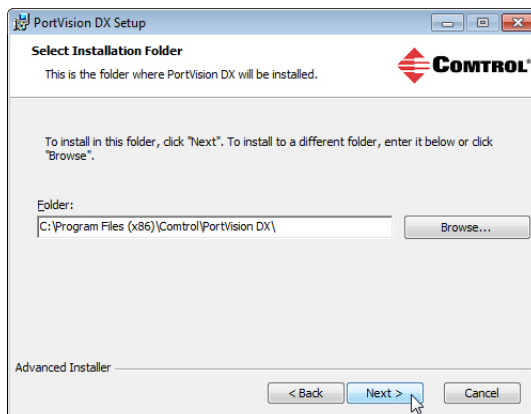
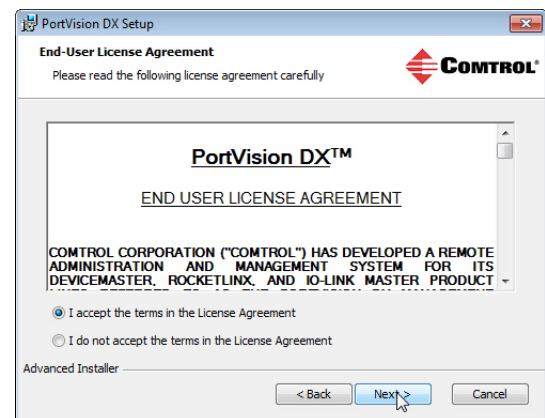
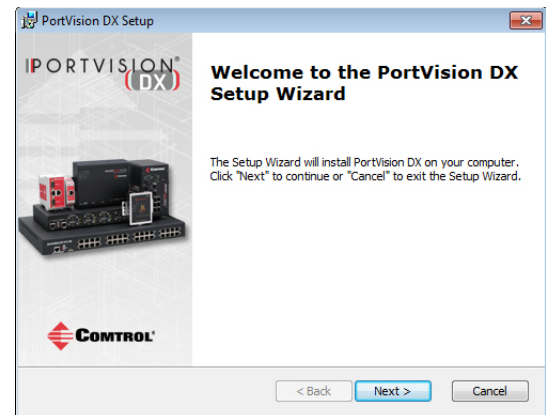

6. Click **Next** to configure the shortcuts.
7. Click **Install**.

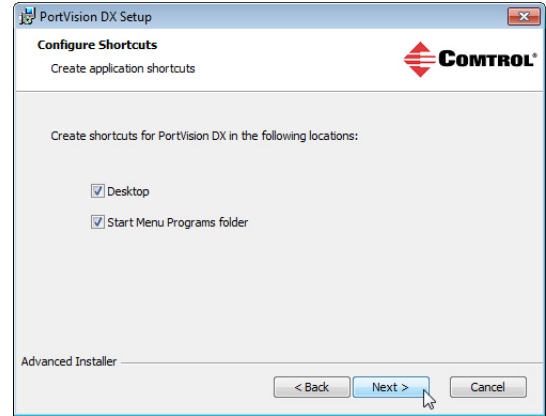
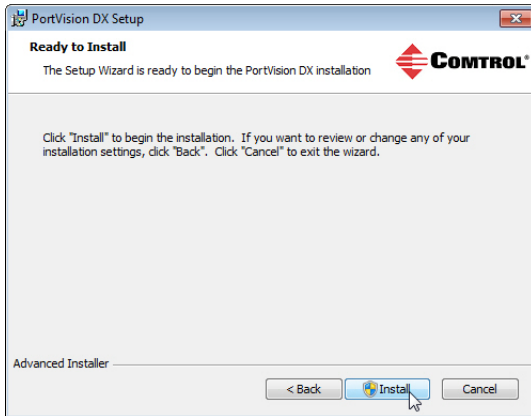

8. Depending on the operating system, you may need to click **Yes** to the *Do you want to allow the following program to install software on this computer?* query.
9. Click **Launch PortVision DX** and **Finish** in the last installation screen.
10. Depending on the operating system, you may need to click **Yes** to the *Do you want to allow the following program to make changes to this computer?* query.
11. Go the next subsection to use PortVision DX to program the network information.

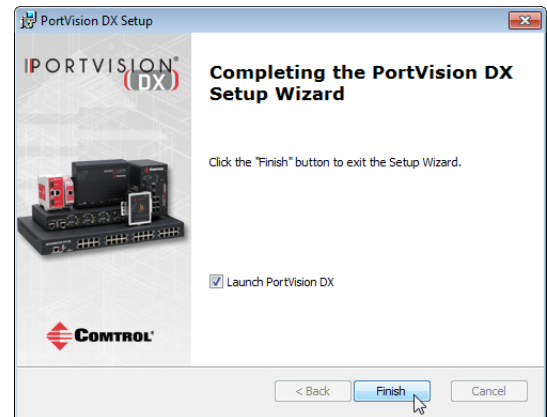

## Configuring the Network Settings

---

---

The ES8508 has the following default values when shipped from the factory:

- IP address: 192.168.250.250
- Subnet mask: 255.255.0.0
- Gateway address: 192.168.250.1

Use the following procedure to change the default network settings on the ES8508 for your network.

1. If necessary, start PortVision DX using the **PortVision DX** desktop shortcut or from the **Start** button, click **All Programs > Control > PortVision DX > PortVision DX**.

**Note:** Depending on your operating system, you may need to click **Yes** to the *Do you want to allow the following program to make changes to this computer?* query.

2. Click the **Scan** button in the *Toolbar*.
3. Select the Control Ethernet attached products that you want to locate and then click **Scan**.

*You can save time if you only scan for RocketLinx switches.*

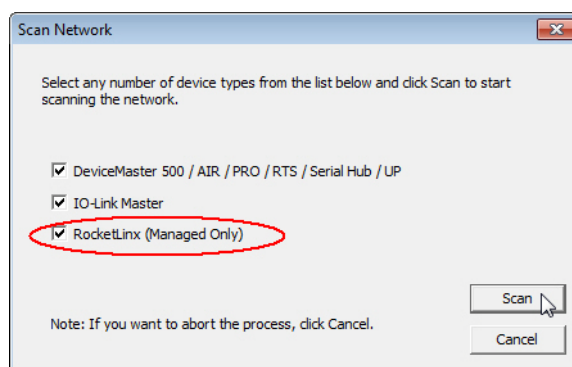

**Note:** If the Control Ethernet attached product is not on the local segment and it has been programmed with an IP address, it will be necessary to manually add the Control Ethernet attached product to PortVision DX.

4. Highlight the ES8508 for which you want to program network information and open the **Properties** screen using one of these methods.
  - Double-click the ES8508 in the *Device Tree* or *Device List* pane.
  - Highlight the ES8508 in the *Device Tree* or *Device List* pane and click the **Properties** button.
  - Right-click the ES8508 in the *Device Tree* or *Device List* pane and click **Properties** in the popup menu
  - Highlight the ES8508, click the **Manage** menu and then **Properties**.

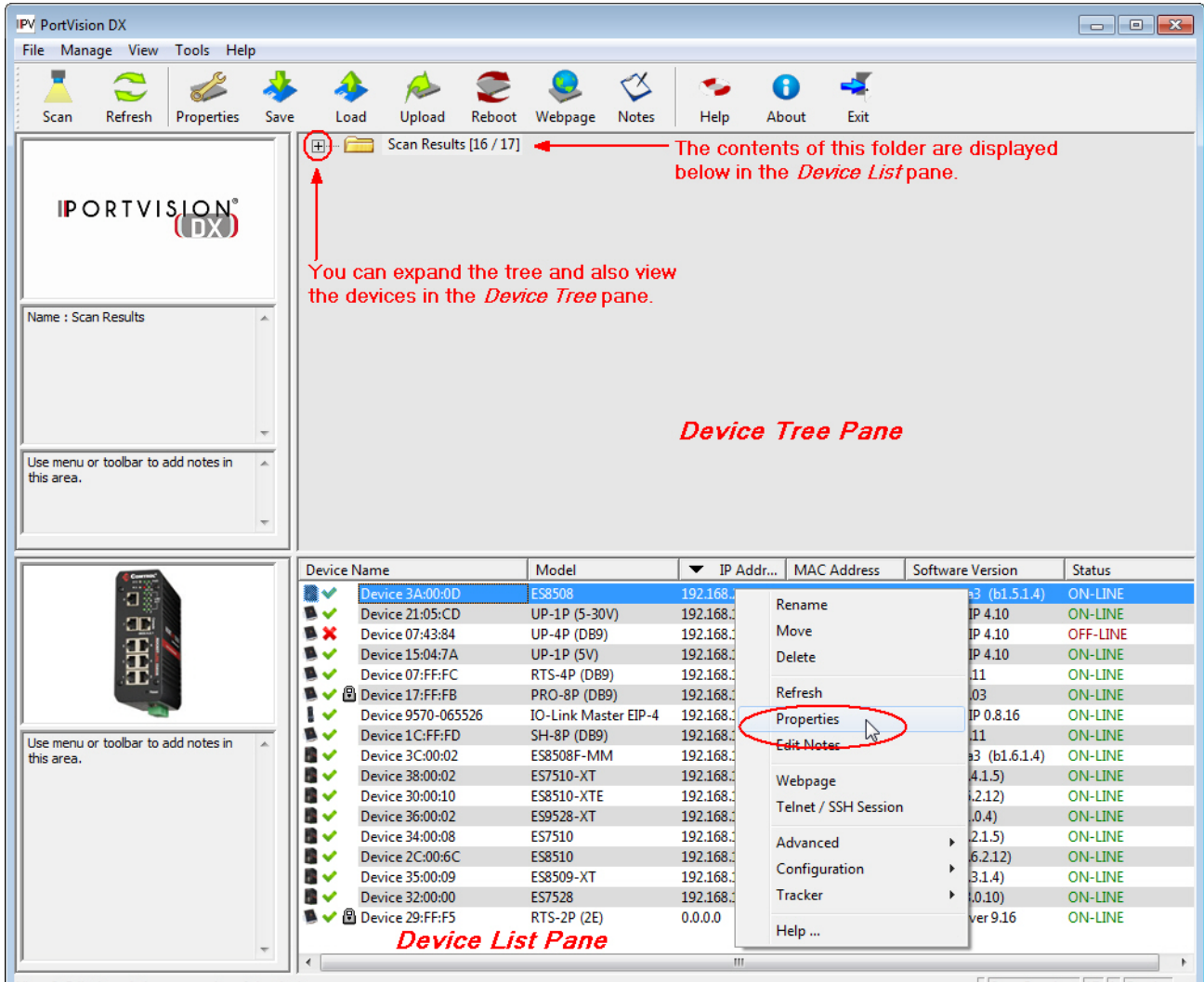

5. *Optionally*, rename the ES8508 in the **Device Name** field for a PortVision DX friendly name. The default name displays as *Device* and the last three sets of hex numbers from the MAC address.

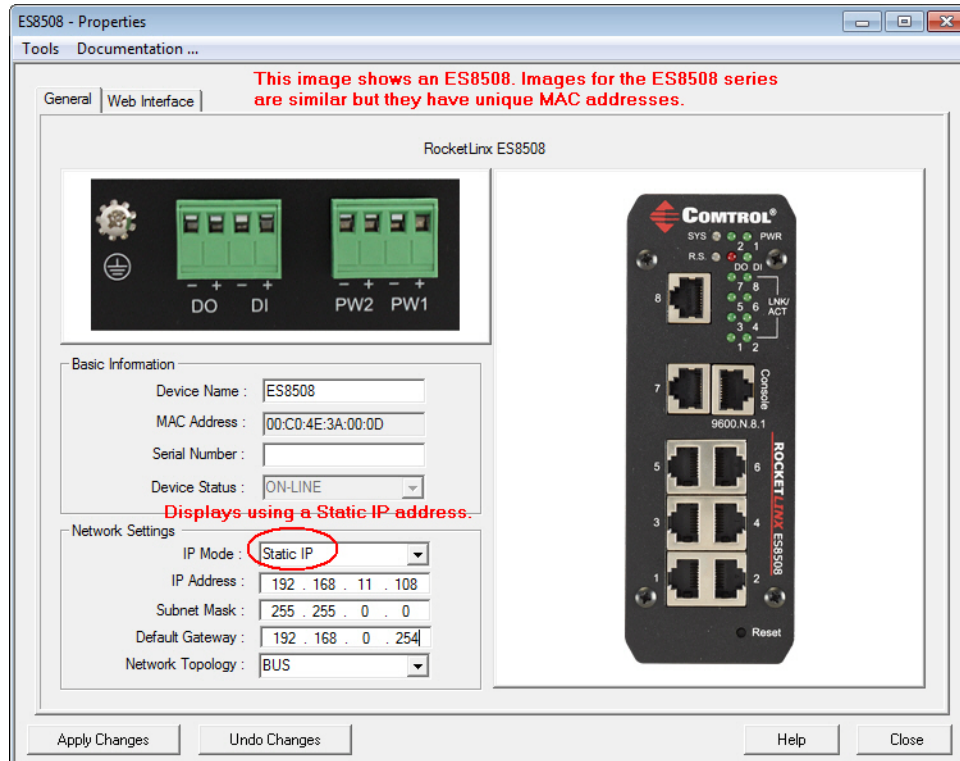

**Note:** The MAC address and Device Status fields are automatically populated and you cannot change these values.

6. *Optionally*, enter the serial number, which is on a label on the ES8508.
7. Select **DHCP IP** or **Static IP** for the *IP Mode*.
- If you select **DHCP IP**, go to [Step 8](#).
  - If you select **Static IP**:
    - Enter a unique **IP address** as required for your site.
    - Enter a valid **Subnet Mask** value for your network.
    - Enter a valid **Default Gateway** value for your network.
8. *Optionally*, select the **Network Topology** type, which is an informational field.
9. Click **Apply Changes** to update the network information on the ES8508.
- Note:** If you are deploying multiple ES8508 switches that share common values, you can save the configuration file and load that configuration onto other ES8508 switches. See [Using Configuration Files](#) on Page 29 for more information.
10. Click **Close** to exit the *Properties* window.
11. You should verify that you have the latest firmware loaded on the ES8508 because a newer version typically includes feature enhancements and bug fixes. Refer to [Checking the Firmware Version](#) on Page 24 and if necessary, [Uploading the Latest Firmware or Bootloader](#) on Page 25.
12. If you have the latest firmware, you can begin feature configuration, see one of these sections:
- [Configuration Using the Web User Interface](#) on Page 35
  - [Configuration Using the Command Line Interface \(CLI\)](#) on Page 131
  - Right-click the ES8508 in the *Device List* pane and click **Webpage** in the popup menu.

**Note:** The default User Name and Password are both **admin**.

## Checking the Firmware Version

Checking your web interface and bootloader versions is easy in PortVision DX.

Control recommends loading the latest firmware and bootloader so that you have all of the latest feature enhancements and bug fixes.

1. If the ES8508 is not displayed in PortVision DX, click the **Scan** button.
2. Select the Control Ethernet attached product type and click the **Scan** button.
3. Locate the ES8508 in the *Device List* pane. Under *Software Version*:
  - The first number reflects the firmware version.
  - The second number displays the bootloader version.

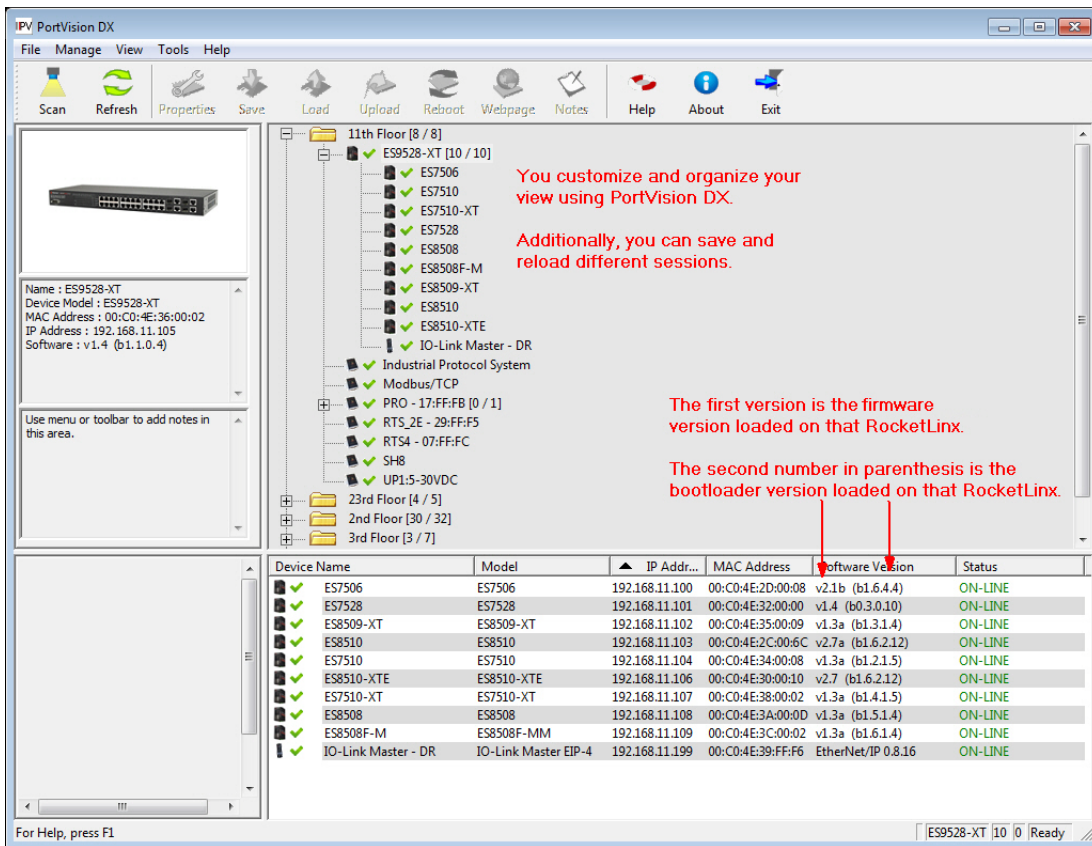
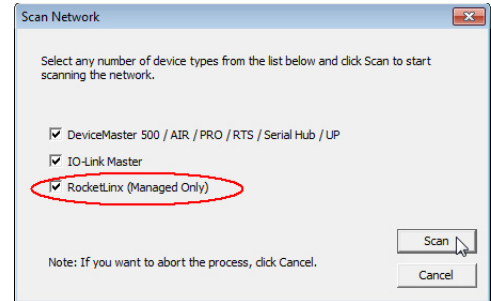

4. Check the [Control ftp](#) site for the latest firmware and bootloader. Simply, click your product type and click the **Software** link and check the latest version against the version on the ES8508.

Use the next subsection for procedures to upload the firmware (web interface) and bootloader.



## Uploading the Latest Firmware or Bootloader

You can use the following procedure to upload the latest firmware or bootloader.

1. If you have not done so, download the latest firmware and bootloader using the previous subsection.
2. Right-click the ES8508 in the *Device List* pane that you want to update, click **Advanced --> Upload firmware**.

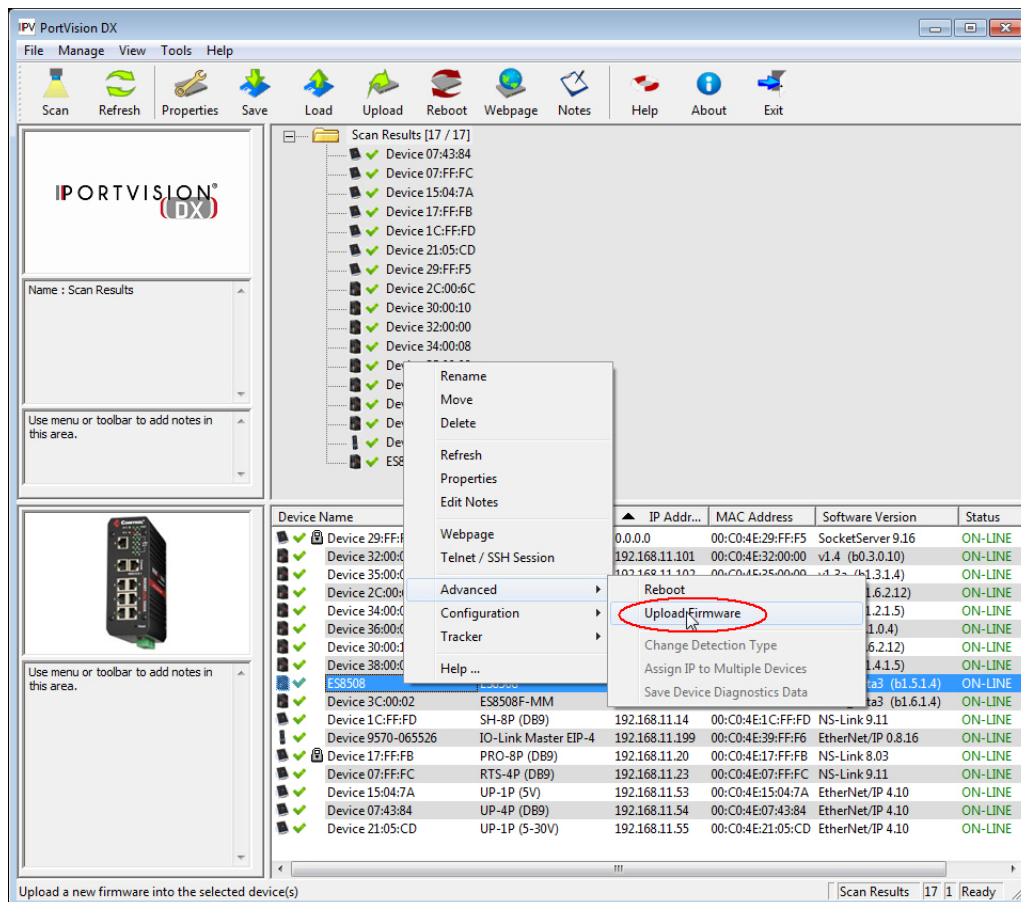

3. Click **Yes** to the *Upload Firmware* message.
4. Click **Ok** to the message notifying you that you should wait to use the ES8508 when the status returns to **ON-LINE**.

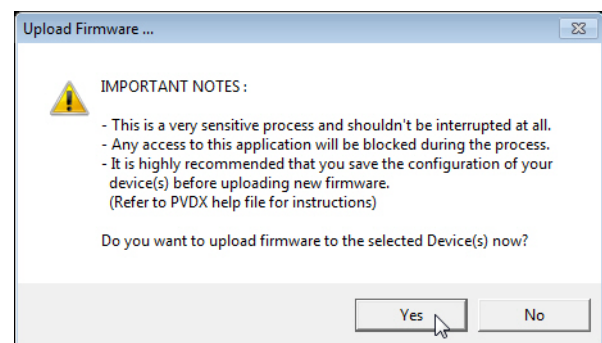
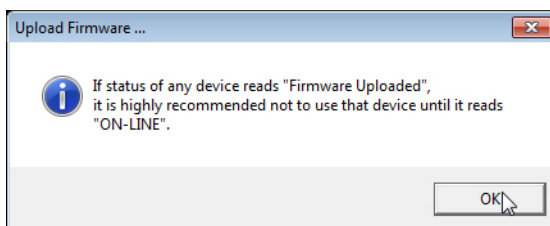

5. Right-click ES8508 in the *Device List* pane and click **Refresh**. Optionally, you can click the **Refresh** button in the *Toolbar* and that refreshes all devices in PortVision DX.
6. Verify that the version change is reflected in under the *Software Version*.



## Configuring Multiple RocketLinx Switches Network Addresses

---

---

You can configure the network addresses for multiple ES8508 switches using the **Assign IP to Multiple Devices** option.

In addition, you can also configure common settings for the ES8508 web page and save the settings to a configuration file that you can load to all or selected ES8508 switches. See [Using Configuration Files](#) on Page 29 for more information.

You can use this procedure if your ES8508 is connected to the host PC, laptop, or if the ES8508 resides on the local network segment. Use the following steps to configure multiple ES8508 switches.

1. Shift-click the ES8508 switches for which you want to program network information, right-click, and click **Advanced > Assign IP to Multiple Devices**.
2. Enter the starting IP address, subnet mask, IP Gateway and click **Proceed**.

PortVision DX displays the programmed IP addresses in the *Device List* pane after the next refresh cycle.

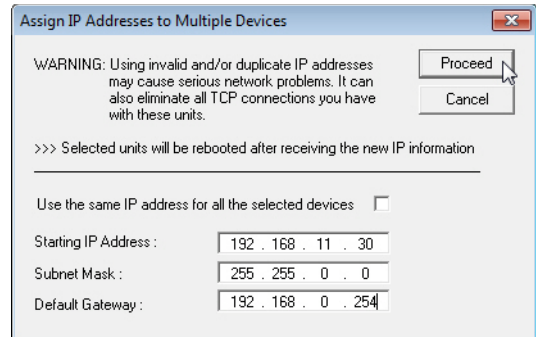

## Uploading Firmware to Multiple ES8508 Switches

You can use this procedure if your ES8508 is connected to the host PC, laptop, or if the ES8508 resides on the local network segment.

**Note:** Technical support does not advise uploading bootloader to multiple ES8508 switches. Remember that uploading firmware reboots the ES8508, which depending on your network connections may cause firmware uploading to fail on another ES8508.

1. If you have not done so, install PortVision DX ([Installing PortVision DX](#) on Page 37) and Scan the network.
1. If the ES8508 is not displayed in PortVision DX, click the **Scan** button.
2. Select the Control Ethernet attached product type and click the **Scan** button.
3. Shift-click the multiple ES8508 switches on the **Main** screen that you want to update and use one of the following methods:
  - Click the **Upload** button.
  - Right-click and then click **Advanced > Upload Firmware**.
  - Click **Advanced > Upload Firmware** in the **Manage** menu.

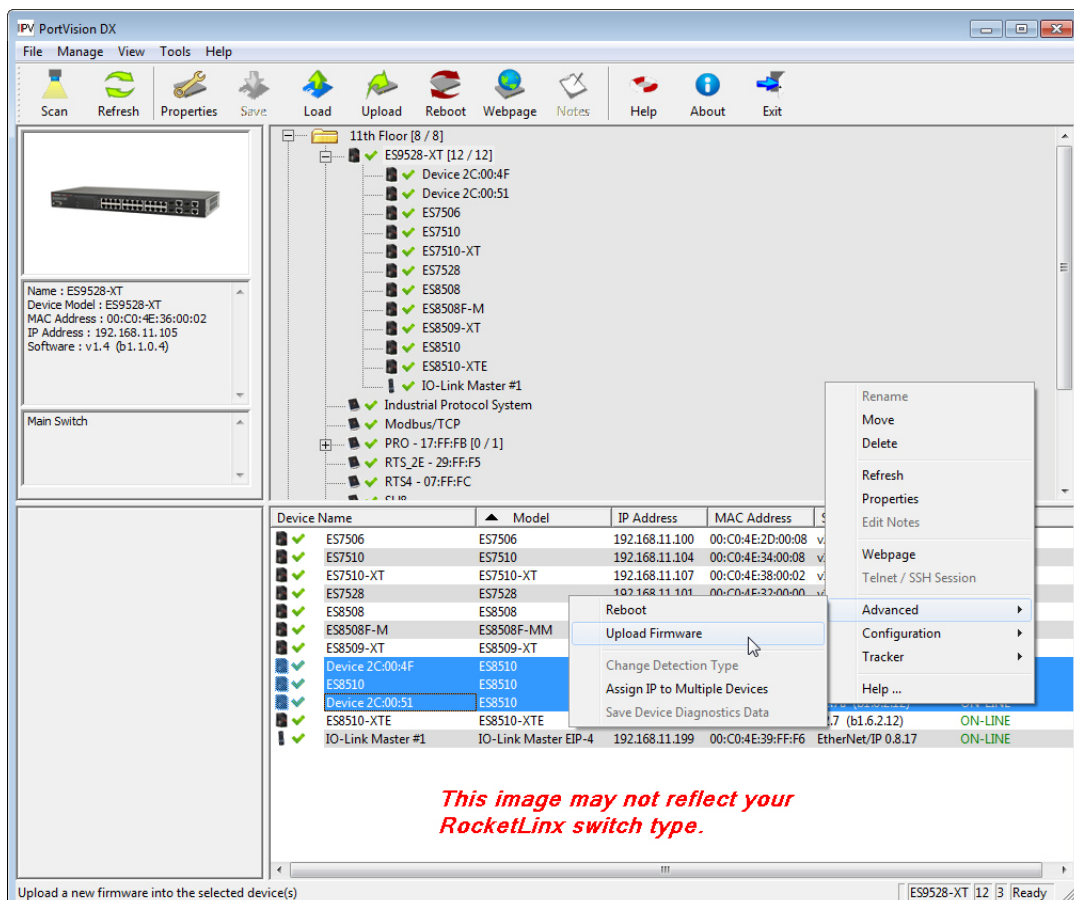
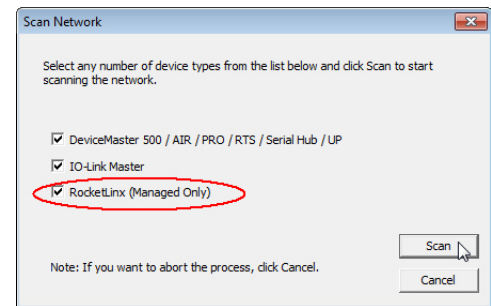

4. Browse, click the firmware (.bin) file, **Open** (*Please locate the new firmware*), and then click **Yes** (*Upload Firmware*).

It may take a few minutes for the firmware to upload onto all of the ES8508 switches. The ES8508 reboots itself during the upload process.

5. Click **Ok** to the advisory message about waiting to use the device until the status reads **ON-LINE**.

In the next polling cycle, PortVision DX updates the *Device List* pane and displays the new firmware version.

## Adding a New Device in PortVision DX

You can add a new ES8508 manually, if you do not want to scan the network to locate it or you want to pre-configure an ES8508 before connecting it to the network. Optionally, you can also add unmanaged devices or RocketLinX switches to maintain information about devices on the network.

See the PortVision DX help system for additional information about adding unmanaged RocketLinX switches or third party devices or switches.

Use the following procedure to add a remote ES8508 to PortVision DX.

1. Access the *New Device* window using one of these methods:
  - Click **Add New > Device** in the *Manage* menu.
  - Right-click a folder or a RocketLinX switch in the *Device Tree* pane and click **Add New > Device**.

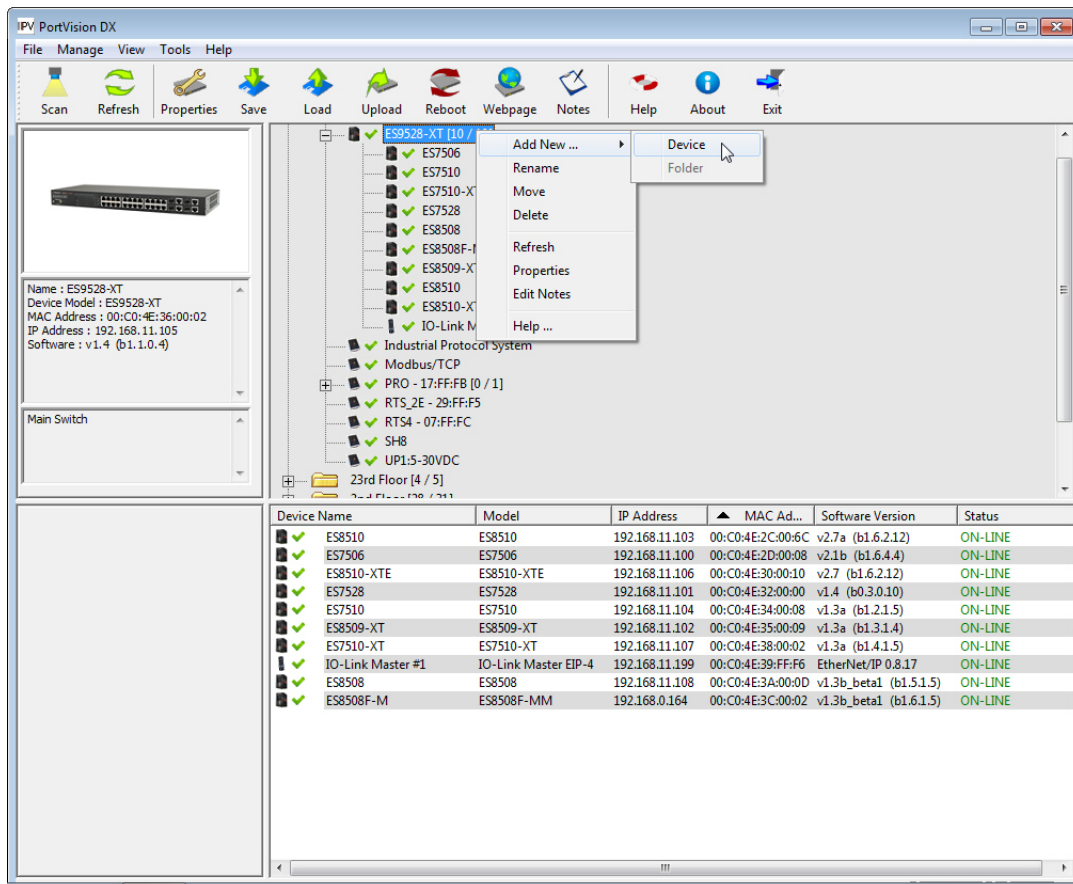

2. Select the appropriate RocketLinX in the **Device Type** drop list.
3. Select the appropriate model in the **Device Model** drop list.
4. Enter a friendly device name in the **Device Name** list box.
5. Optionally, enter the serial number in the **Serial Number** list box.

- Enter the IP Address for the ES8508. It is not necessary to enter the Subnet Mask and Default Gateway

- Click **Ok** to close the *Add New Device* window. It may take a few moments to save the ES8508.
- If necessary, click **Refresh** for the new RocketLinx to display in the *Device Tree* or *Device List* panes. The RocketLinx shows OFF-LINE if it is not connected to the local network or if an incorrect IP address was entered.

## Using Configuration Files

If you are deploying multiple ES8508 switches that share common firmware values, you can save the configuration file (.dc) from the *Main* screen in PortVision DX and load that configuration onto other ES8508 switches.

You may want to program the network settings in multiple ES8508 switches using [Configuring Multiple RocketLinx Switches Network Addresses](#) on Page 26.

### Saving a Configuration File

Use this procedure to save a configuration file.

- Highlight the ES8508 in the *Device List* pane and use one of the following methods:
  - Click the **Save** button.
  - Right-click and then click **Configuration > Save**.
- Browse to the location you want to save the file, enter a file name, and click **Save**.
- Click **Ok** to close the *Save Configuration Completed* message.

### Loading a Configuration File

Use the following procedure to load a previously saved a ES8508 configuration file. Load a configuration file and apply it to a selected ES8508 switch or switches from the *Device List* pane.

Use this procedure to load a configuration file using the *Device List* pane to one or more ES8508 switches.

- Highlight the device or devices in the *Device List* pane and use one of the following methods:
  - Click the **Load** button
  - Right-click and then click **Configuration > Load**
- Click **Yes** to the warning that it will take 25 seconds per device and it may also reboot the devices.
- Browse to the location of the configuration file, click the file name (.dc) and then **Open**.
- Close the *Load Configuration* popup message.

## Using the LED Tracker

RocketLinx managed switches support the LED Tracker feature, which allows you to toggle on/off the LEDs on a specific device so that you can locate the physical unit.

Use this procedure to toggle the **LED Tracker** feature on RocketLinx switches.

1. Right-click the ES8508 in the *Device List* pane, click **Tracker**, and then click **ON**.

The ES8508 **SYS LED** will flash for five seconds.

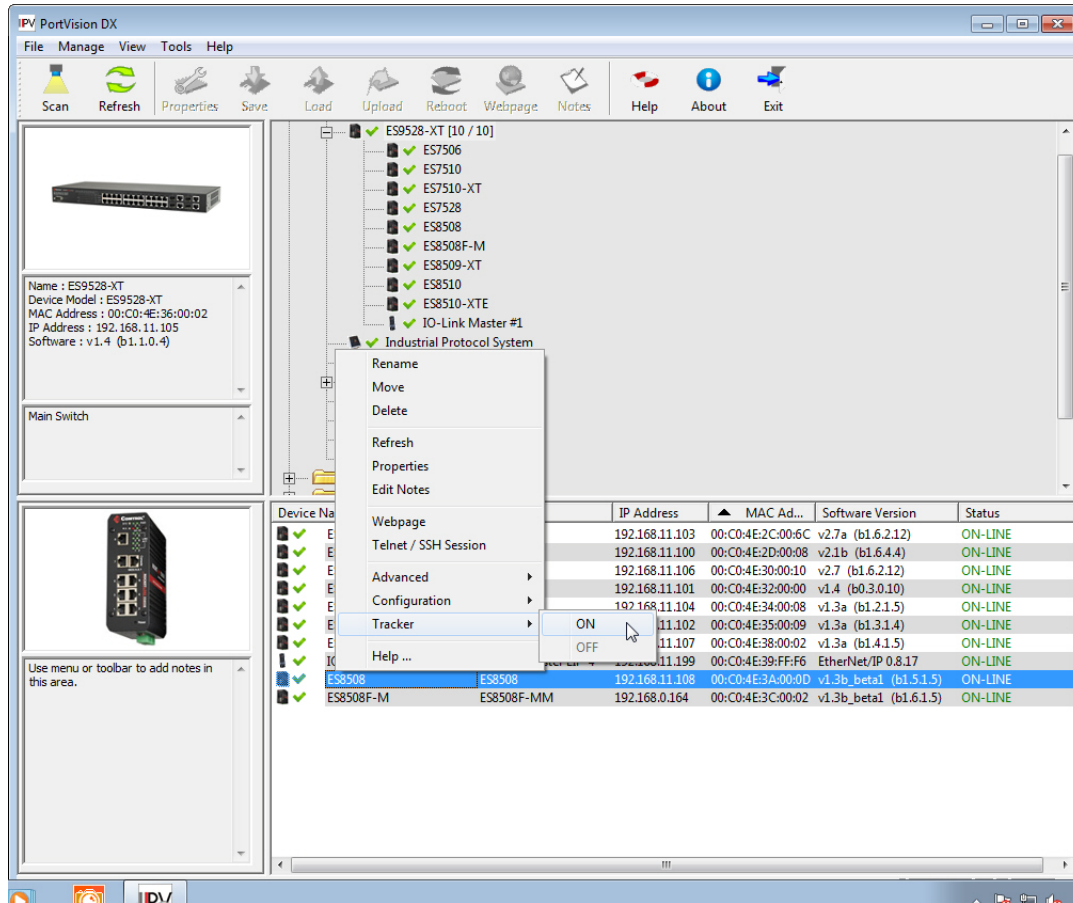

2. If necessary, you may need to click **Tracker** and **ON** several times to catch the flashing **SYS LED**.

## Customizing PortVision DX

You can customize how PortVision DX displays the devices. You can even create sessions tailored for specific audiences. You can also add shortcuts to other applications using **Tools > Applications > Customize** feature.

The following illustrates how you can customize your view.

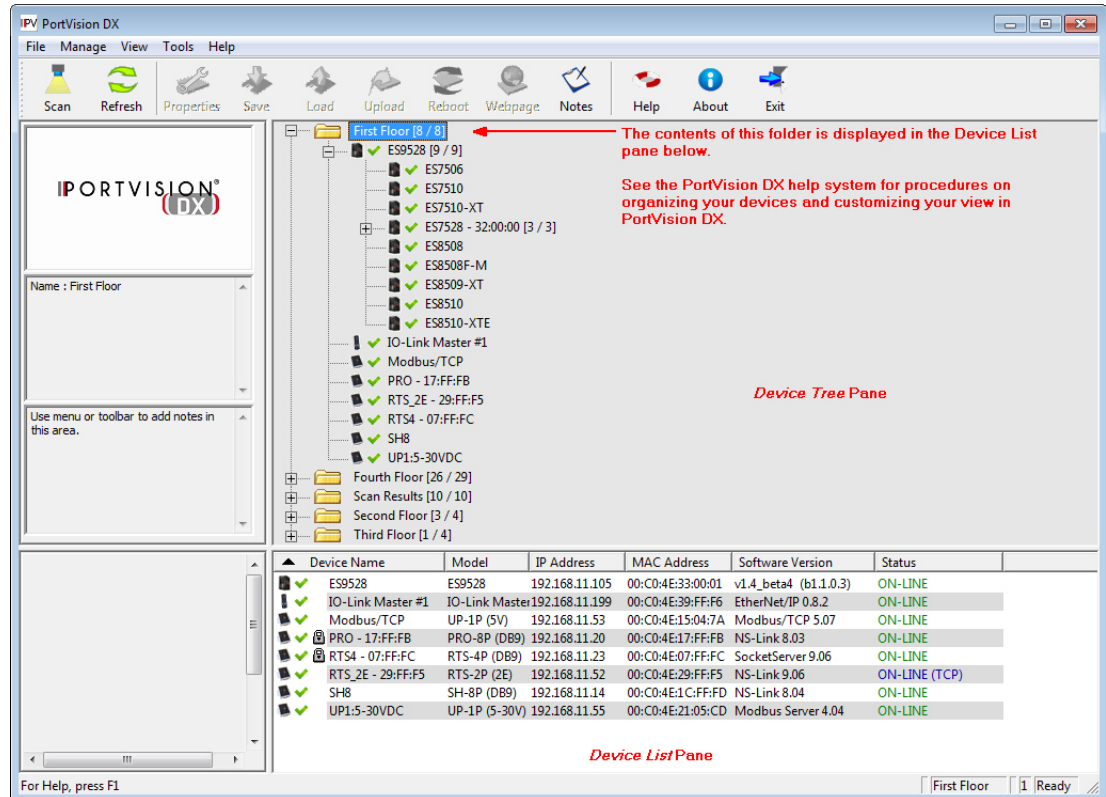

See the PortVision DX Help system for detailed information about modifying the view. For example, the above screen shot illustrates devices layered in folders.

## Accessing RocketLinx Documentation from PortVision DX

You can use this procedure in PortVision DX to [download](#) and [open the previously downloaded documents](#) for the RocketLinx. You can also check to see if you have the latest version of the documentation using PortVision DX.

### How to Download Documentation

Use this procedure to initially download a document or documents.

1. If necessary, open PortVision DX.
2. Click **Help > Documentation**.
3. Optionally, click the **DOWNLOAD THE CURRENT DOCUMENTATION CATALOG ONLINE** button to make sure that the latest documentation is available to PortVision DX.

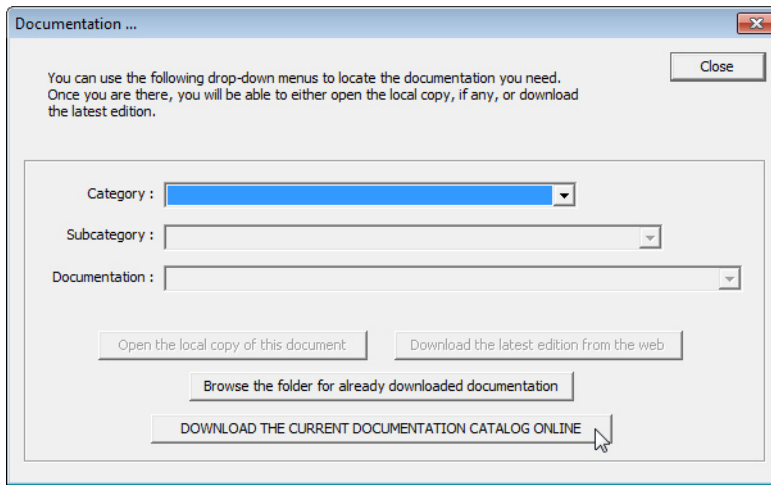
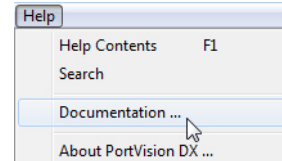

4. Select the product **Category** from the drop list.
5. Select the document you want to download from the **Documentation** drop list.

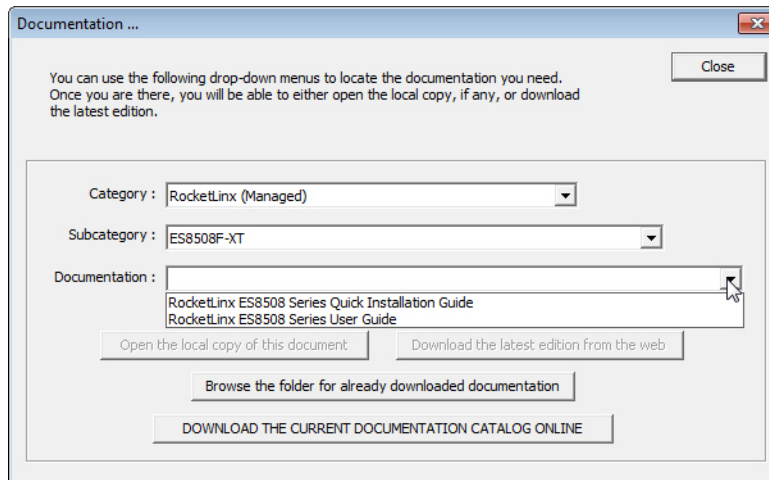

**Note:** This image may not reflect your RocketLinx.

6. Click the **Download the latest edition from the web** button.

**Note:** It may take a few minutes to download, depending on your connection speed. The document opens automatically after it has downloaded.



- Click **Close** if you have downloaded all of the documents that you wanted.

### How to Open Previously Downloaded Documents

Use the following procedure to access previously downloaded documents in PortVision DX.

**Note:** *Optionally, you can browse to the **Program Files (x86) > Control > PortVision DX > Docs** subdirectory and open the document.*

- If necessary, open **PortVision DX > Start/Programs > Control > PortVision DX > PortVision DX** or use the desktop shortcut.
- Click **Help > Documentation**.
- Click the **Open the local copy of the document** button to view the document.

**Note:** *This image may not reflect your RocketLinx.*

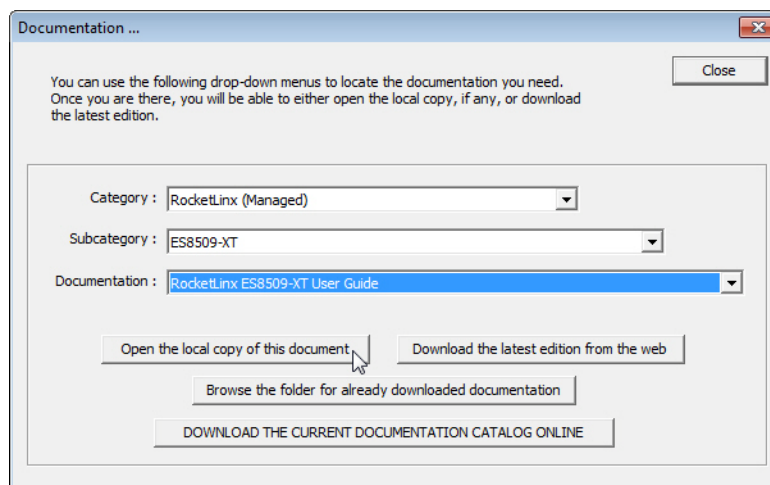

**Note:** *If the document fails to open, it may be that your browser has been disabled. You can still access the document by clicking the **Browse the folder for already downloaded documentation** button and opening the document with your custom browser.*

- Click **Close** in the *Documentation...* popup, unless you want to open or download other documents.



# Configuration Using the Web User Interface

The ES8508 provides in-band and out-band configuration methods:

- Out-band management means that you configure the ES8508 using the RS-232 console cable and the Command Line Interface (CLI) to access the ES8508 without attaching an admin PC to the network. You can use out-band management if you lose the network connection to the ES8508. The CLI and Telnet are discussed in [Configuration Using the Command Line Interface \(CLI\)](#) on Page 131.
- In-band management means that you connect remotely using the ES8508 IP address through the network. You can remotely connect with the ES8508 embedded Java applet web user interface or a Telnet console and the CLI. The ES8508 provides HTTP web user interface ([Page 36](#)) and secure HTTPS web user interface ([Page 38](#)) for web management.

## Configuration Overview

---

---

This subsection discusses a minimum level of configuration required to operate the ES8508.

1. If you have not done so, install the hardware, see [Hardware Installation](#) on Page 9.
2. If you are planning on using in-band management, you need to program the ES8508 IP address to meet your network requirements. The easiest way to configure the IP address is using a Windows system and PortVision DX, see [Configuring the Network Settings](#) on Page 21.
3. Configure other features as desired. You can refer to the [Feature Overview](#) on Page 40 to locate configuration information or use these links:
  - [Basic Settings](#) on Page 49
  - [Port Configuration](#) on Page 70
  - [Network Redundancy](#) on Page 76
  - [VLAN](#) on Page 89
  - [Private VLAN](#) on Page 97
  - [Traffic Prioritization](#) on Page 100
  - [Multicast Filtering](#) on Page 103
  - [SNMP](#) on Page 107
  - [Security](#) on Page 110
  - [Warning](#) on Page 116
  - [Monitor and Diag](#) on Page 121
  - [Device Front Panel](#) on Page 128
  - [Save to Flash](#) on Page 129
  - [Logout](#) on Page 129

## Web User Interface

The ES8508 web management page was developed with Java. You can use any standard web browser, which is compatible with Java Runtime to configure and communicate with the ES8508 from anywhere on the network.

If you did not program the IP address for your network using PortVision DX ([Programming Network Information](#) on Page 18), you need to change your computer IP address to **192.168.250.x** (Network Mask: 255.255.0.0). The default IP address for the ES8508 is *192.168.250.250*.

1. If necessary, install the latest version of the [Java Runtime Environment](#).
2. Open a command prompt window and ping the IP address for the ES8508 to verify a normal response time.

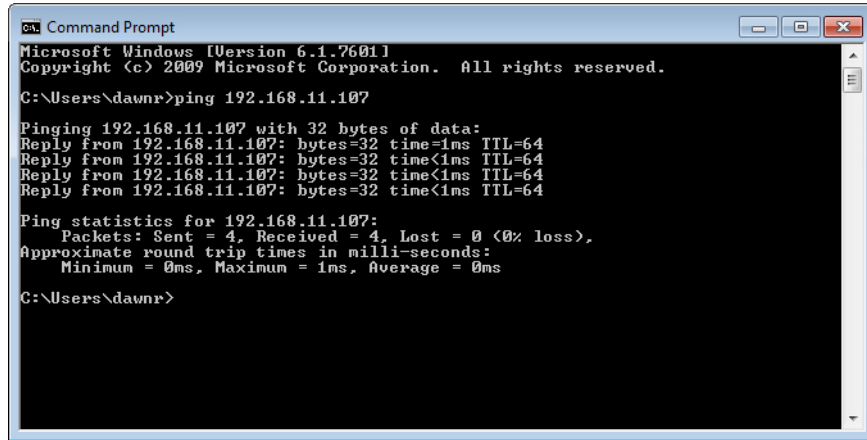

3. Launch the web browser on the PC using one of these methods:
  - Right-click the ES8508 in PortVision DX and click **Webpage**.
  - Type **http://192.168.250.250** (or the IP address of the switch), and then press **Enter**.

**Note:** Since Java is constantly updated, the prompts may be different from what the following subsections display.

### Windows XP - Windows Server 2003

If a *Warning - Security* message appears, click **Always trust content from this publisher** and then **Run** when requested to run the application (IP address).

### Windows Vista - Windows 8

If necessary, click **I accept the risk and want to run this application**, and then **Run** if a security warning popup message appears.

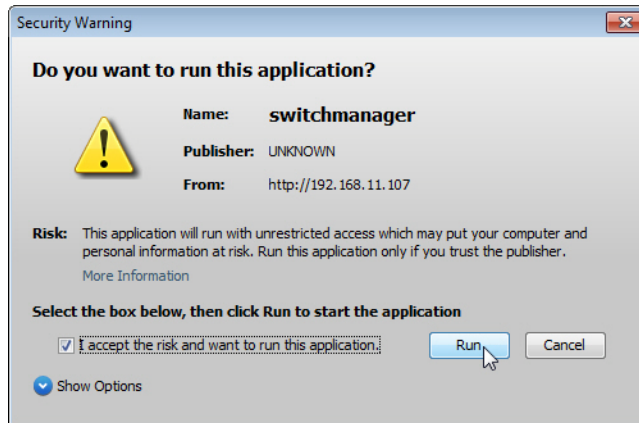

4. Enter the user name, the password, and click **OK**. The default user name and password are both **admin**.

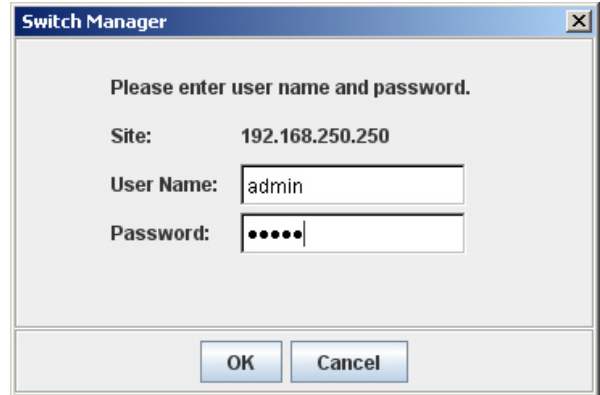

The *Welcome* page of the web management interface then appears.

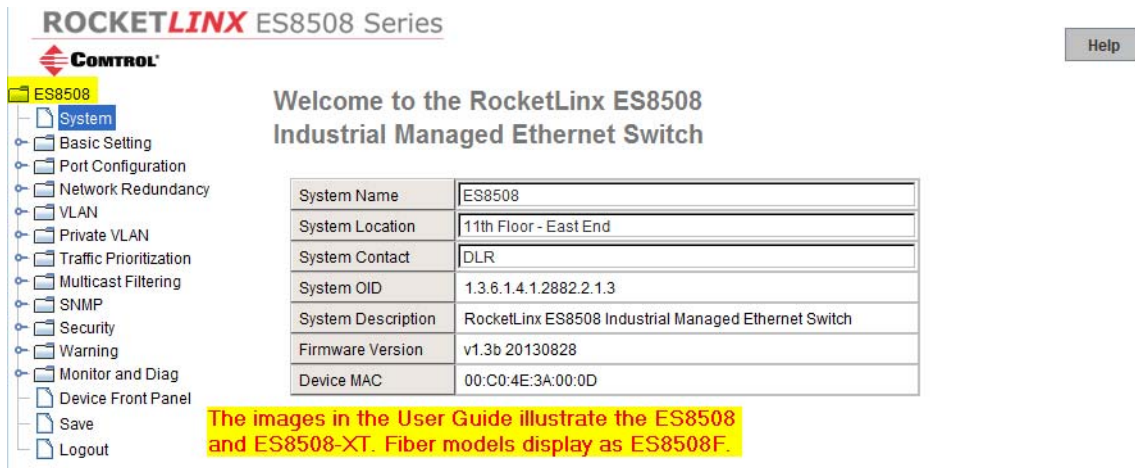

5. If you have not done so, you can change the ES8508 IP address to meet your network environment.
  - a. Double-click **Basic Setting**.
  - b. Click **IP Configuration**.  
 To use static addressing, enter a valid IP address, subnet mask and default gateway.  
 To use DHCP, click **Enable** in the **DHCP Client** drop list.
  - c. Click **Apply**.

You can use the [Feature Overview](#) on Page 40 to locate other features that you may want to configure.

## Secure Web User Interface

The ES8508 web user interface also provides secured management through an HTTPS login so that all of the configuration commands are secure.

If you did not program the IP address for your network using PortVision DX ([Configuring the Network Settings](#) on Page 21), you need to change your computer IP address to **192.168.250.x** (Network Mask: 255.255.0.0). The default IP address for the ES8508 is *192.168.250.250*.

1. Open a command prompt window and ping the IP address for the ES8508 to verify a normal response time.

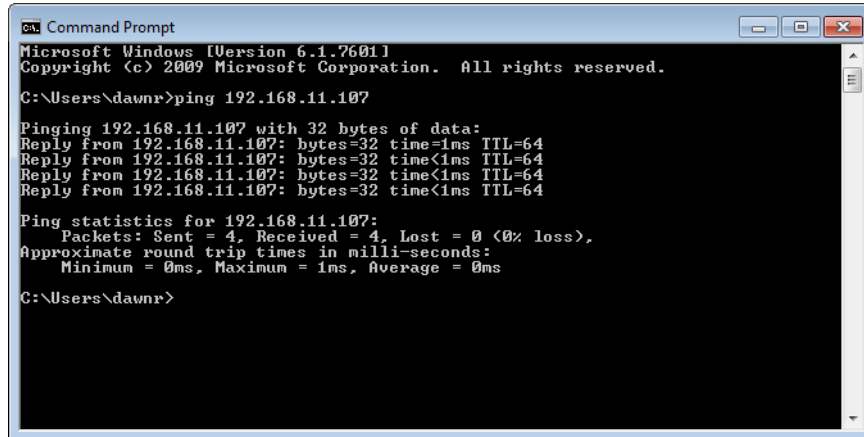

2. Launch the web browser and type **https://192.168.250.250** (or the IP address of the ES8508).and then press **Enter**.
3. Click **Continue to the web site (not recommended)**.

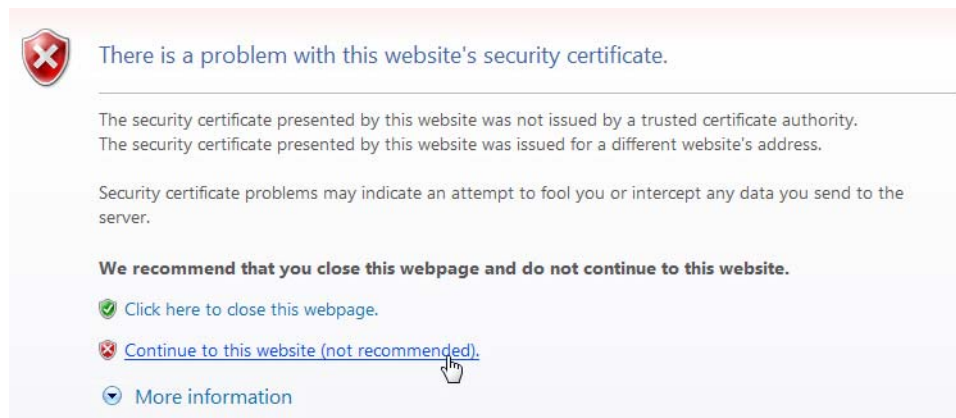

**Windows XP and Windows Server 2003**

- a. Click **No** when the popup screen appears and requests you to trust the secured HTTPS connection distributed by the ES8508.
- b. Click **Always trust content from this publisher** and then **Run** when requested to run the application (IP address) in the *Warning - Security* message.

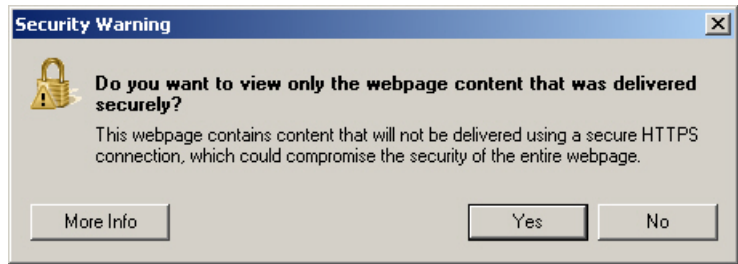

**Windows Vista - Windows 7**

- a. Click the **Continue** button.



- b. If necessary, click **I accept the risk and want to run this application** and then **Run** if a security warning popup message appears.

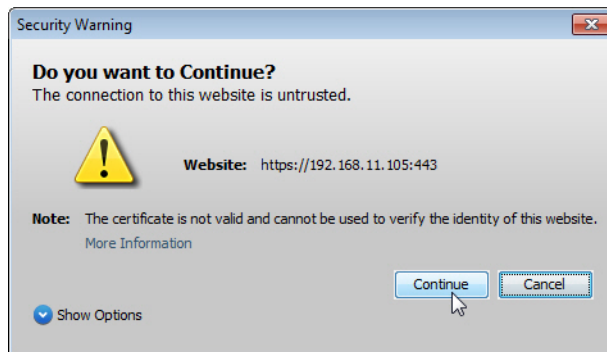

- 4. Enter the user name and the password and click **OK**. The default user name and password are both **admin**.



The *Welcome* page of the web management interface then appears.

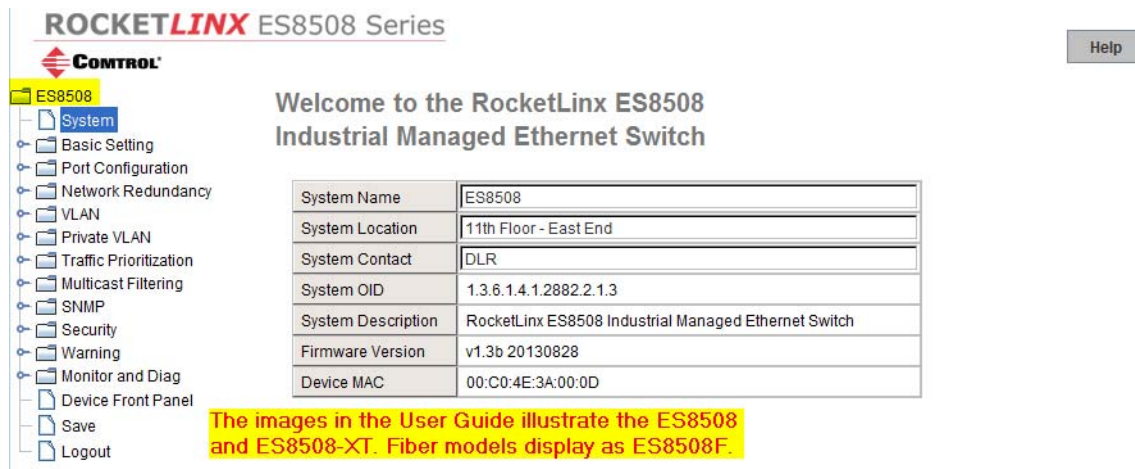

5. If you have not done so, you can change the ES8508 IP address to meet your network environment.
  - a. Double-click **Basic Setting**.
  - b. Click **IP Configuration**.
    - To use static addressing, enter a valid IP address, subnet mask and default gateway.
    - To use DHCP, click **Enable** in the **DHCP Client** drop list.
  - c. Click **Apply**.

You can use the [Feature Overview](#) on Page 40 to locate other features that you may want to configure.

## Feature Overview

The following table provides detailed information about ES8508 features and provides the location of the configuration information in the web user interface.

Type	Category	Details
802.1x Port-Based Network Access Control Configuration	<a href="#">802.1x Configuration</a> on Page 112	<ul style="list-style-type: none"> <li>• System Authentication Control - Enable/Disable</li> <li>• Authentication Method - RADIUS or Local</li> <li>• RADIUS Server - IP Address, Shared Key, Server Port, and Accounting Port</li> <li>• Local RADIUS User - User Name, Password, and VID</li> <li>• Secondary RADIUS Server - IP Address, Shared Key, Server Port, and Accounting Port</li> <li>• Local RADIUS User List</li> </ul>



Type	Category	Details
802.1x Port-Based Network Access Control Port Configuration	<a href="#">802.1x Port Configuration</a> on Page 113	Port Configuration <ul style="list-style-type: none"> <li>• Port Control - Auto, Forced Authorized, or Force Unauthorized</li> <li>• Re-authentication - Enable/Disable</li> <li>• Maximum Request</li> <li>• Guest VLAN</li> <li>• Host Mode - Single/Multi</li> <li>• Admin Control Direction - Both or In</li> </ul> Timeout Configuration <ul style="list-style-type: none"> <li>• Port by Port</li> <li>• Re-Authentication Periods</li> <li>• Quiet Period</li> <li>• Tx Period</li> <li>• Supplicant Timeouts</li> <li>• Server Timeouts</li> </ul>
802.1x Port-Based Network Access Control Port Status	<a href="#">802.1x Port Status</a> on Page 115	<ul style="list-style-type: none"> <li>• Port by Port</li> <li>• Port Control</li> <li>• Authorize Status</li> <li>• Authorized Supplicant</li> <li>• Oper Control Direction</li> </ul>
Admin Password	<a href="#">Admin Password</a> on Page 50	<ul style="list-style-type: none"> <li>• Admin</li> </ul>
Backup and Restore	<a href="#">Backup and Restore</a> on Page 61	Local or TFTP
CoS-Queuing Mapping	<a href="#">CoS-Queue Mapping</a> on Page 101	<ul style="list-style-type: none"> <li>• CoS 0 through 7</li> <li>• Queue 0 through 3</li> <li>• Queue 3 highest priority</li> </ul>
DHCP Server Configuration	<a href="#">DHCP Server Configuration</a> on Page 56 <a href="#">DHCP Leased Entries</a> on Page 58 <a href="#">DHCP Relay Agent</a> on Page 59	<ul style="list-style-type: none"> <li>• DHCP Server Configuration                         <ul style="list-style-type: none"> <li>- Excluded Addresses and Manual Binding</li> <li>- Port and IP Address</li> <li>- Option 82</li> </ul> </li> <li>• DHCP Leased Entries</li> <li>• DHCP Relay Agent                         <ul style="list-style-type: none"> <li>- Helper Address 1-4</li> <li>- DHCP Option82 Relay Agent (Circuit ID/Remote ID)</li> </ul> </li> </ul>
DSCP-Queuing Mapping	<a href="#">DSCP-Queue Mapping</a> on Page 102	<ul style="list-style-type: none"> <li>• DSCP 0 through 7</li> <li>• Queue 0 through 3</li> <li>• Queue 3 highest priority</li> </ul>

Type	Category	Details
Event Selection	<a href="#">Event Selection</a> on Page 118	<ul style="list-style-type: none"> <li>• Device Cold Start</li> <li>• Device Warm Start</li> <li>• Authentication Failure</li> <li>• Time Synchronization Failure</li> <li>• Power 1 Failure</li> <li>• Power 2 Failure</li> <li>• Fault Relay</li> <li>• DI1 Change</li> <li>• Ring Event</li> <li>• Loop Protection</li> <li>• Ring Topology Change</li> <li>• Port by Port Event Selection</li> </ul>
Fault Relay	<a href="#">Warning</a> on Page 116	Relay 1- Multi-event <ul style="list-style-type: none"> <li>• Power - DC1, DC2, or Any</li> <li>• Port Link (Port or Ports)</li> <li>• Ring Failure</li> <li>• Ping Failure - IP Address</li> <li>• Ping Reset, IP Address, Reset Time (Sec), and Hold Time (Sec)</li> <li>• Dry Output - On Period (Sec) and Off Period (Sec)</li> </ul>
GMRP Configuration	<a href="#">Multicast Filtering</a> on Page 103	<ul style="list-style-type: none"> <li>• Enable/Disable</li> <li>• Port by Port Basis</li> </ul>
GVRP Configuration	<a href="#">GVRP Configuration</a> on Page 95	<ul style="list-style-type: none"> <li>• 2K Entries</li> <li>• Enable/Disable GVRP Protocol</li> <li>• State - Enable/Disable</li> <li>• Join Timer</li> <li>• Leave Timer</li> <li>• Leave All Timer</li> </ul>
IGMP Query	<a href="#">IGMP Query</a> on Page 105	<ul style="list-style-type: none"> <li>• Version - Version 1, Version 2, or Disable</li> <li>• Query Intervals</li> <li>• Query Maximum Response Time</li> </ul>
IGMP Snooping	<a href="#">IGMP Snooping</a> on Page 104	<ul style="list-style-type: none"> <li>• Enable/Disable</li> <li>• VID</li> <li>• Port by Port IGMP Snooping Table               <ul style="list-style-type: none"> <li>- IP Address</li> <li>- VID</li> </ul> </li> </ul>
IP Configuration	<a href="#">Basic Settings</a> on Page 49	<ul style="list-style-type: none"> <li>• IPv4 and IPv6 support</li> <li>• DHCP</li> <li>• DNS1 and DNS2</li> </ul>

Type	Category	Details
IP Security	<a href="#">IP Security</a> on Page 111	<ul style="list-style-type: none"> <li>• Enable/Disable</li> <li>• Security IP</li> <li>• Security IP List - Index and Security IP</li> </ul>
Loop Protection	<a href="#">Loop Protection</a> on Page 88	<ul style="list-style-type: none"> <li>• Transmit Interval</li> <li>• Enable/Disable port by port</li> <li>• Status</li> </ul>
MAC Address Table (8K)	<a href="#">MAC Address Table</a> on Page 121	<ul style="list-style-type: none"> <li>• Aging Time (Sec)</li> <li>• Static Unicast MAC Address - MAC Address, VID, and Port</li> <li>• Port by Port MAC Address Table View               <ul style="list-style-type: none"> <li>- Static Unicast</li> <li>- Dynamic Unicast</li> <li>- Static Multicast</li> <li>- Dynamic Multicast</li> </ul> </li> </ul>
MSTP Configuration	<a href="#">MSTP Configuration</a> on Page 81	<ul style="list-style-type: none"> <li>• MSTP Region Configuration - Name and Revision</li> <li>• New MST Instance - Instance ID, VLAN Group, and Instance Priority</li> <li>• Current MST Instance Configuration - Instance ID, VLAN Group, and Instance Priority</li> </ul>
MSTP Information	<a href="#">MSTP Information</a> on Page 84	<ul style="list-style-type: none"> <li>• Instance ID</li> <li>• Root Information               <ul style="list-style-type: none"> <li>- Root Address</li> <li>- Root Priority</li> <li>- Root Port</li> <li>- Root Path Cost</li> <li>- Maximum Age</li> <li>- Hello Time</li> <li>- Forward Delay</li> </ul> </li> <li>• Port Information               <ul style="list-style-type: none"> <li>- Role</li> <li>- Port State</li> <li>- Path Cost</li> <li>- Port Priority</li> <li>- Link Type</li> <li>- Edge Port</li> </ul> </li> </ul>
MSTP Port Configuration	<a href="#">MSTP Port Configuration</a> on Page 83	Instance ID <ul style="list-style-type: none"> <li>• Port</li> <li>• Path Cost</li> <li>• Priority</li> <li>• Link Type</li> <li>• Edge Port</li> </ul>

Type	Category	Details
Ping Utility	<a href="#">Ping Utility</a> on Page 127	Target IP Address
Port Control	<a href="#">Port Control</a> on Page 70	<ul style="list-style-type: none"> <li>• Enable/Disable Port State</li> <li>• Speed/Duplex - Auto-Negotiation, 10 Full/Half, and 100 Full/Half (ES8508)</li> <li>• Speed/Duplex - Auto-Negotiation, 10 Full/Half, and 100 Full/Half - Ports 1-6 and 100Full - Ports 7 - 8 (ES8508F)</li> <li>• Flow control - Disable/Symmetric</li> <li>• User-Defined Description</li> </ul>
Port Mirror Mode	<a href="#">Port Mirroring</a> on Page 124	<ul style="list-style-type: none"> <li>• Port Mirror Mode - Enable/Disable</li> <li>• Port by Port                             <ul style="list-style-type: none"> <li>- Source Port - Rx and Tx</li> <li>- Destination Port - Rx and Tx</li> </ul> </li> </ul>
Port Security	<a href="#">Port Security</a> on Page 110	<ul style="list-style-type: none"> <li>• Port Security State - Port by Port</li> <li>• Add Port Security Entry - Port, VID, and MAC Address</li> <li>• Port Security Entry List - Port VID, and MAC Address</li> </ul>
Port Statistics	<a href="#">Port Statistics</a> on Page 123	Port by Port <ul style="list-style-type: none"> <li>• Type</li> <li>• Link</li> <li>• State</li> <li>• Rx and Tx Good</li> <li>• Rx and Tx Bad</li> <li>• Rx Abort</li> <li>• Collision</li> </ul>
Port Status	<a href="#">Port Status</a> on Page 72	<ul style="list-style-type: none"> <li>• Port Type</li> <li>• Link - Up/Down</li> <li>• State - Enable/Disable</li> <li>• Speed/Duplex</li> <li>• Flow Control</li> </ul>
Port Trunk	<a href="#">Aggregation Setting</a> on Page 74 <a href="#">Aggregation Status</a> on Page 75	Aggregation Settings <ul style="list-style-type: none"> <li>• Group ID - Trunk 1-8</li> </ul> Trunk Type - Static or 802.3ad LACP Aggregation Status by Trunk <ul style="list-style-type: none"> <li>• Type</li> <li>• Aggregated Ports</li> <li>• Individual Ports</li> <li>• Link down Ports</li> </ul>
PVLAN Configuration	<a href="#">PVLAN Configuration</a> on Page 97	<ul style="list-style-type: none"> <li>• VLAN ID</li> <li>• PVLAN Type - None, Primary, Isolated, and Community</li> </ul>

Type	Category	Details
PVLAN Information	<a href="#">PVLAN Information</a> on Page 99	<ul style="list-style-type: none"> <li>• Primary VLAN</li> <li>• Secondary VLAN</li> <li>• Secondary VLAN Type</li> <li>• Ports</li> </ul>
PVLAN Port Configuration	<a href="#">PVLAN Port Configuration</a> on Page 98	Port Configuration <ul style="list-style-type: none"> <li>• PVLAN Port Type - Normal, Host, or Promiscuous</li> <li>• VLAN ID</li> </ul> PVLAN Association <ul style="list-style-type: none"> <li>• Secondary VLAN</li> <li>• Primary VLAN</li> </ul>
QoS Setting	<a href="#">QoS Setting</a> on Page 100	Queue scheduling <ul style="list-style-type: none"> <li>• Use 8.4.2.1 Weighted Fair Queuing Scheme</li> <li>• Use A Strict Priority Scheme</li> </ul> Port Setting <ul style="list-style-type: none"> <li>• CoS - 0 through 7</li> <li>• Trust Mode - COS Only, DSCP Only, COS First, or DSCP First</li> </ul>
Rate Control	<a href="#">Rate Control</a> on Page 73	<ul style="list-style-type: none"> <li>• Ingress Packet Types - Broadcast Only, Broadcast/Multicast, Broadcast/Multicast/Unknown Unicast, and All</li> <li>• Ingress Rate (1 Mbps to 100Mbps)</li> <li>• Egress Packet Type</li> <li>• Egress Rate (1 Mbps to 100Mbps)</li> </ul>
Redundant Ring	<a href="#">Redundant Ring</a> on Page 86	<ul style="list-style-type: none"> <li>• Ring ID and Name</li> <li>• Ring Configuration               <ul style="list-style-type: none"> <li>- ID</li> <li>- Name</li> <li>- Version (Super Ring and Rapid Super Ring)</li> <li>- Device Priority</li> <li>- Ring Port</li> <li>- Path Cost</li> <li>- Ring Port2</li> <li>- Path Cost</li> <li>- Rapid Dual Homing</li> <li>- Ring Status</li> </ul> </li> </ul>

Type	Category	Details
Redundant Ring Information	<a href="#">Redundant Ring Information</a> on Page 87	<ul style="list-style-type: none"> <li>• 32 Ring ID Maximum</li> <li>• Supports up to four 100M rings</li> <li>• Version</li> <li>• Role</li> <li>• Status</li> <li>• RM MAC</li> <li>• Blocking Port</li> <li>• Role Transition Count</li> <li>• Ring State Transition Count</li> </ul>
Reset/Reboot	<a href="#">Factory Defaults</a> on Page 69 <a href="#">System Reboot</a> on Page 69	<ul style="list-style-type: none"> <li>• System Reset Button</li> <li>• Reset to Factory Default Values</li> <li>• Reboot from Interface</li> </ul>
SNMP Configuration	<a href="#">SNMP Configuration</a> on Page 107	<ul style="list-style-type: none"> <li>• V1/V2c Community</li> <li>• Public - Read Only or Read and Write</li> <li>• Private - Read Only or Read and Write</li> </ul>
SNMP Traps	<a href="#">SNMP Traps</a> on Page 109	<ul style="list-style-type: none"> <li>• Enable/Disable</li> <li>• Trap Server - Server IP Address, Community, and Version (V1 or V2c)</li> <li>• Trap Server Profile - Displays Server IP, Community, and Version</li> </ul>
SNMP V3 Profile	<a href="#">SNMP V3 Profile</a> on Page 108	SNMP V3 <ul style="list-style-type: none"> <li>• User Name</li> <li>• Security Level</li> <li>• Authentication Level</li> <li>• Authentication Password</li> <li>• DES Password</li> </ul> SNMP V3 Users - Displays Profile Information
STP Configuration	<a href="#">STP Configuration</a> on Page 77	<ul style="list-style-type: none"> <li>• STP, RSTP, MSTP, or Disable</li> <li>• Bridge Address</li> <li>• Bridge Priority</li> <li>• Maximum Age</li> <li>• Hello Time</li> <li>• Forward Delay</li> </ul>

Type	Category	Details
STP Information	<a href="#">STP Information</a> on Page 79	<ul style="list-style-type: none"> <li>• Root Information               <ul style="list-style-type: none"> <li>- Root Address</li> <li>- Root Priority</li> <li>- Root Port</li> <li>- Root Path Cost</li> <li>- Maximum Age</li> <li>- Hello Time</li> <li>- Forward Delay</li> </ul> </li> <li>• Port Information               <ul style="list-style-type: none"> <li>- Role</li> <li>- Port State</li> <li>- Path Cost</li> <li>- Port Priority</li> <li>- Link Type</li> <li>- Edge Port</li> <li>- Aggregated (D/Type)</li> </ul> </li> </ul>
STP Port Configuration	<a href="#">STP Port Configuration</a> on Page 78	Port by Port <ul style="list-style-type: none"> <li>• STP State</li> <li>• Path Cost</li> <li>• Priority</li> <li>• Link Type</li> <li>• Edge Port</li> </ul>
SYSLOG Mode	<a href="#">SysLog Configuration</a> on Page 119	<ul style="list-style-type: none"> <li>• Disable, Local, Remote, or Both</li> <li>• Remote IP Address</li> </ul>
System Event Logs	<a href="#">Event Log</a> on Page 125	<ul style="list-style-type: none"> <li>• Index</li> <li>• Date</li> <li>• Time</li> <li>• Event Log</li> </ul>
Time Setting	<a href="#">Time Setting</a> on Page 53	<ul style="list-style-type: none"> <li>• IEEE 1588</li> <li>• Manual or NTP Client</li> <li>• Time Zone Setting</li> <li>• Daylight Savings Time</li> </ul>
Topology Discovery	<a href="#">Topology Discovery (LLDP)</a> on Page 126	<ul style="list-style-type: none"> <li>• LLDP - Enable/Disable</li> <li>• LLDP Configuration - Timer and Hold Time</li> <li>• LLDP Port State - Local Port, Neighbor ID, Neighbor IP, and Neighbor VID</li> </ul>
Unknown Multicast	<a href="#">Unknown Multicast</a> on Page 105	<ul style="list-style-type: none"> <li>• Send to Query Ports</li> <li>• Send to All Ports</li> <li>• Discard</li> </ul>

Type	Category	Details
Upgrade Firmware	<a href="#">Firmware Upgrade</a> on Page 67	Local or TFTP
VLAN Configuration	<a href="#">VLAN Configuration</a> on Page 92	<ul style="list-style-type: none"> <li>• Tunneling support for 256</li> <li>• Management VLAN ID</li> <li>• Static VLAN - ID and Name</li> <li>• Static VLAN Configuration - VLAN ID, Name, and Ports (Options: No VLAN, Trunk Link, or Access Link)</li> </ul>
VLAN Port Configuration	<a href="#">VLAN Port Configuration</a> on Page 90	<ul style="list-style-type: none"> <li>• PVID</li> <li>• Tunnel Mode</li> <li>• EtherType</li> <li>• Accept Frame Type</li> <li>• Ingress Filtering</li> </ul>
VLAN Table	<a href="#">VLAN Table</a> on Page 96	<ul style="list-style-type: none"> <li>• VLAN ID</li> <li>• Name</li> <li>• Status</li> <li>• Port by Port</li> </ul>
Warning - SMTP Configuration	<a href="#">SMTP Configuration</a> on Page 120	<ul style="list-style-type: none"> <li>• Email Alert - Enable/Disable</li> <li>• SMTP Server IP</li> <li>• Mail Account</li> <li>• Authentication</li> <li>• User Name</li> <li>• Password</li> <li>• Recipient Email Address 1-4</li> </ul>



## Basic Settings

The *Basic Setting* group allows you the ability to configure switch information, IP address, User name/ Password of the system. It also allows you to do firmware upgrade, backup and restore configuration, reload factory default, and reboot the system.

The following web pages are included in this group:

- [Switch Setting](#) on Page 49
- [Admin Password](#) on Page 50
- [IP Configuration](#) on Page 51
- [Time Setting](#) on Page 53
- [DHCP Server Configuration](#) on Page 56
- [Backup and Restore](#) on Page 61
- [Firmware Upgrade](#) on Page 67
- [Factory Defaults](#) on Page 69
- [System Reboot](#) on Page 69

**Note:** This User Guide refers to all three models as the ES8508 unless there is information specific between the models.

Optionally, you can use the CLI for configuration, see [Basic Settings \(CLI\)](#) on Page 146.

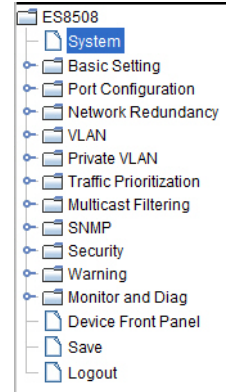

## Switch Setting

You can assign the System Name, Location, Contact and view ES8508 information.

### Switch Setting

System Name	ES8508
System Location	11th Floor - East End
System Contact	DLR
System OID	1.3.6.1.4.1.2882.2.1.3
System Description	RocketLinx ES8508 Industrial Managed Ethernet Switch
Firmware Version	v1.3b 20130828
Device MAC	00:C0:4E:3A:00:0D

#### **ES8508F and ES8508F-XT:**

*System Description displays as RocketLinx ES8508F Industrial Managed Ethernet Switch. The MAC address is 00 C0 4E 3C xx xx. and the System OID is unique.*

Switch Setting Page	
System Name	You can assign a name to the ES8508. You can input up to 64 characters. After you configure the name, The CLI system selects the first 12 characters as the name in CLI system.
System Location	You can specify the ES8508 physical location with up to 64 characters.
System Contact	You can specify contact people with up to 64 characters by typing the Administrator's name, mail address or other information.

Switch Setting Page (Continued)	
System OID	The SNMP Object ID of the ES8508. You can follow the path to find its private MIB in an MIB browser. <i>Note: When you attempt to view private MIB, you should first compile private MIB files into your MIB browser.</i>
System Description	RocketLinx ES8508 or RocketLinx ES8508F Industrial Managed Ethernet Switch is the system description.
Firmware Version	Displays the firmware version installed in this ES8508.
Device MAC	Displays a unique hardware address (MAC address) assigned in the factory.
Apply	Click <b>Apply</b> to apply the settings. <i>Note: You must <b>Save</b> the settings (<a href="#">Page 129</a>), if you want to maintain these settings if the ES8508 is powered off.</i>

### Admin Password

You can change the user name and the password here to enhance security.

Admin Password	Description
User name	You can enter a new user name here. The default name is <b>admin</b> .
Password	You can enter a new password here. The default password is <b>admin</b> .
Confirm Password	You need to type the new password again to confirm it.
Apply	Click <b>Apply</b> to apply the settings. <i>Note: You must <b>Save</b> the settings (<a href="#">Page 129</a>), if you want to maintain these settings if the ES8508 is powered off.</i>

#### Admin Password

Name	<input type="text" value="admin"/>
Password	<input type="password" value="••••"/>
Confirm Password	<input type="password" value="••••"/>
<input type="button" value="Apply"/>	

## IP Configuration

This function allows you to configure the ES8508's IP address settings.

### IP Configuration

**DHCP Client**  ▾

IP Address	192.168.11.108
Subnet Mask	255.255.0.0
Default Gateway	192.168.0.254
DNS Server 1	
DNS Server 2	

### IPv6 Configuration

IPv6 Address	Prefix
<input type="text"/>	<input type="text"/>

IPv6 Address	Prefix
fe80::2c0:4eff:fe3a:d	64
<input type="text"/>	<input type="text"/>

### IPv6 Default Gateway

Default Gateway
<input type="text"/>

### IPv6 Neighbor Table

Neighbor	Interface	MAC address	State
<input type="text"/>	<input type="text"/>	<input type="text"/>	<input type="text"/>

IP Configuration Page	
DHCP Client	You can select to <b>Enable</b> or <b>Disable</b> the DHCP Client function. When the DHCP Client function is enabled, an IP address is assigned to the switch from the network's DHCP server. In this mode, the default IP address is replaced by the one assigned by DHCP server. If DHCP Client is disabled, then the IP address that you specified is used.
IP Address	You can assign the IP address reserved by your network for the ES8508. If the DHCP Client function is enabled, you do not need to assign an IP address to the ES8508, because it is overwritten by the DHCP server and displays here. The default IP Address is 192.168.250.250.

<b>IP Configuration Page (Continued)</b>	
Subnet Mask	<p>You can assign the subnet mask for the IP address here. If the DHCP Client function is enabled, you do not need to assign the subnet mask. The default Subnet Mask is 255.255.255.0.</p> <p><b>Note:</b> <i>In the CLI, the enabled bit of the subnet mask is used to represent the number displayed in the web management interface. For example, 8 represents: 255.0.0.0,16 represents: 255.255.0.0, 24 represents: 255.255.255.0.</i></p>
Default Gateway	<p>You can assign the gateway for the switch here. The default gateway is 192.168.250.1.</p> <p><b>Note:</b> <i>In the CLI, use 0.0.0.0/0 to represent the default gateway.</i></p>
DNS Server 1/2	<p>The Domain Name System (DNS) is a hierarchical naming system built on a distributed database for computers, services, or any resource connected to the Internet or a private network. It associates various information with domain names assigned to each of the participating entities. Most importantly, it translates domain names meaningful into the numerical identifiers associated with networking equipment for the purpose of locating and addressing these devices worldwide.</p>
IPv6 Address	<p>You can enter an IPv6 address for the ES8508.</p> <p>An IPv6 address is represented as eight groups of four hexadecimal digits, each group representing 16 bits (two octets). The groups are separated by colons (:), and the length of IPv6 address is 128bits.</p> <p>The 64-bit interface identifier is automatically generated from the MAC address for the ES8508 using the modified EUI-64 format.</p>
Prefix	<p>This IPv6 prefix specifies the size of a network or subnet. The default is 64.</p>
IPv6 Default Gateway	<p>The IPv6 default gateway IP address identifies the gateway (for example, a router) that receives and forwards those packets whose addresses are unknown to the local network. The agent uses the default gateway address when sending alert packets to the management workstation on a network other than the local network.</p>
<b>IPv6 Neighbor Table</b>	
Neighbor	<p>The <i>IPv6 Neighbor Table</i> lists neighbors of the ES8508.</p>
Interface	<p>The interface connected to the neighbor.</p>
MAC address	<p>This is the MAC address of the neighbor.</p>
State	<p>This displays the Neighbor Unreachability Detection (NUD) state of the neighbor entry.</p>
Remove	<p>Click the <b>Remove</b> button to remove an IPv6 configuration or IPv6 Neighbor Table entry.</p>
Reload	<p>Click the <b>Reload</b> button to reload IPv6 configuration.</p>
Apply	<p>Click <b>Apply</b> to apply the settings.</p> <p><b>Note:</b> <i>You must <b>Save</b> the settings (<a href="#">Page 129</a>), if you want to maintain these settings if the ES8508 is powered off.</i></p>

## Time Setting

Time Setting allows you to set the time manually or through a Network Time Protocol (NTP) server. NTP is used to synchronize computer clocks on the internet. You can configure NTP settings here to synchronize the clocks of several switches on the network. The ES8508 also provides Daylight Saving functionality.

### Time Setting

System Time: Fri Jan 2 05:30:58 2009

<b>Time Setting Source</b>		Manual Setting
Manual Setting	Get Time From PC	
Jan	02	, 2009 05 : 30 : 58
<b>IEEE 1588</b>		
PTP State	Disable	
Mode	Auto	
<b>Timezone Setting</b>		
Timezone	(GMT) Greenwich Mean Time: Dublin, Edinburgh, Lisbon, London	
<input type="checkbox"/> <b>Daylight Saving Time</b>		
Daylight Saving Start	1st	Sun in Jan at 00 : 00
Daylight Saving End	1st	Sun in Jan at 00 : 00
Apply		

Time Setting Page	
Time Setting Source	<p><b>Manual Setting:</b> Click <b>Manual Setting</b> to change time as needed. You can also click the <b>Get Time from PC</b> button to get PC's time setting for the ES8508.</p> <p><b>NTP client:</b> Click <b>Time Setting Source</b> if you want the NTP client to permit the ES8508 to enable the NTP client service. NTP client is automatically enabled if you change the Time Setting Source to NTP Client. The system sends a request packet to acquire current time from the NTP server you assign.</p>
IEEE 1588	<p>The IEEE 1588 PTP (Precision Time Protocol) supports very precise time synchronization in an Ethernet network. There are two clocks, master and slave. The master device periodically launches an exchange of messages with slave devices to help each slave clock re-compute the offset between its clock and the master's clock.</p> <p>To enable IEEE 1588, select <b>Enable</b> in the <b>PTP State</b> and choose <b>Auto, Master</b> or <b>Slave Mode</b>. After the time is synchronized, the system time displays the correct time from the PTP server.</p>
Timezone Setting	<p>Select the time zone where the ES8508 is located. The following table lists the time zones for different locations for your reference. The default time zone is (GMT) Greenwich Mean Time.</p>
Daylight Saving Time	<p>Click the <b>Daylight Saving Time</b> check box and then set the <b>Daylight Saving Time Start</b> and <b>End</b> times. During Daylight Saving Time, the ES8508 time is one hour earlier than the actual time.</p>
Apply	<p>Click <b>Apply</b> to apply the settings.</p> <p><b>Note:</b> You must <b>Save</b> the settings (<a href="#">Page 129</a>), if you want to maintain these settings if the ES8508 is powered off.</p>

```
Switch(config)# clock timezone
 01 (GMT-12:00) Eniwetok, Kwajalein
 02 (GMT-11:00) Midway Island, Samoa
 03 (GMT-10:00) Hawaii
 04 (GMT-09:00) Alaska
 05 (GMT-08:00) Pacific Time (US & Canada), Tijuana
 06 (GMT-07:00) Arizona
 07 (GMT-07:00) Mountain Time (US & Canada)
 08 (GMT-06:00) Central America
 09 (GMT-06:00) Central Time (US & Canada)
 10 (GMT-06:00) Mexico City
 11 (GMT-06:00) Saskatchewan
 12 (GMT-05:00) Bogota, Lima, Quito
 13 (GMT-05:00) Eastern Time (US & Canada)
 14 (GMT-05:00) Indiana (East)
 15 (GMT-04:00) Atlantic Time (Canada)
 16 (GMT-04:00) Caracas, La Paz
 17 (GMT-04:00) Santiago
 18 (GMT-03:00) Newfoundland
 19 (GMT-03:00) Brasilia
 20 (GMT-03:00) Buenos Aires, Georgetown
 21 (GMT-03:00) Greenland
 22 (GMT-02:00) Mid-Atlantic
 23 (GMT-01:00) Azores
 24 (GMT-01:00) Cape Verde Is.
 25 (GMT) Casablanca, Monrovia
 26 (GMT) Greenwich Mean Time: Dublin, Edinburgh, Lisbon, London
 27 (GMT+01:00) Amsterdam, Berlin, Bern, Rome, Stockholm, Vienna
 28 (GMT+01:00) Belgrade, Bratislava, Budapest, Ljubljana, Prague
 29 (GMT+01:00) Brussels, Copenhagen, Madrid, Paris
 30 (GMT+01:00) Sarajevo, Skopje, Sofija, Vilnius, Warsaw, Zagreb
 31 (GMT+01:00) West Central Africa
 32 (GMT+02:00) Athens, Istanbul, Minsk
 33 (GMT+02:00) Bucharest
 34 (GMT+02:00) Cairo
 35 (GMT+02:00) Harare, Pretoria
 36 (GMT+02:00) Helsinki, Riga, Tallinn
 37 (GMT+02:00) Jerusalem
 38 (GMT+03:00) Baghdad
 39 (GMT+03:00) Kuwait, Riyadh
 40 (GMT+03:00) Moscow, St. Petersburg, Volgograd
 41 (GMT+03:00) Nairobi
 42 (GMT+03:30) Tehran
 43 (GMT+04:00) Abu Dhabi, Muscat
 44 (GMT+04:00) Baku, Tbilisi, Yerevan
 45 (GMT+04:30) Kabul
 46 (GMT+05:00) Ekaterinburg
 47 (GMT+05:00) Islamabad, Karachi, Tashkent
 48 (GMT+05:30) Calcutta, Chennai, Mumbai, New Delhi
```

- 49 (GMT+05:45) Kathmandu
- 50 (GMT+06:00) Almaty, Novosibirsk
- 51 (GMT+06:00) Astana, Dhaka
- 52 (GMT+06:00) Sri Jayawardenepura
- 53 (GMT+06:30) Rangoon
- 54 (GMT+07:00) Bangkok, Hanoi, Jakarta
- 55 (GMT+07:00) Krasnoyarsk
- 56 (GMT+08:00) Beijing, Chongqing, Hong Kong, Urumqi
- 57 (GMT+08:00) Irkutsk, Ulaan Bataar
- 58 (GMT+08:00) Kuala Lumpur, Singapore
- 59 (GMT+08:00) Perth
- 60 (GMT+08:00) Taipei
- 61 (GMT+09:00) Osaka, Sapporo, Tokyo
- 62 (GMT+09:00) Seoul
- 63 (GMT+09:00) Yakutsk
- 64 (GMT+09:30) Adelaide
- 65 (GMT+09:30) Darwin
- 66 (GMT+10:00) Brisbane
- 67 (GMT+10:00) Canberra, Melbourne, Sydney
- 68 (GMT+10:00) Guam, Port Moresby
- 69 (GMT+10:00) Hobart
- 70 (GMT+10:00) Vladivostok
- 71 (GMT+11:00) Magadan, Solomon Is., New Caledonia
- 72 (GMT+12:00) Auckland, Wellington
- 73 (GMT+12:00) Fiji, Kamchatka, Marshall Is.
- 74 (GMT+13:00) Nuku'alofa

## DHCP Server Configuration

Use this page to configure DHCP server services.

### DHCP Server Configuration

DHCP Server  ▾

#### DHCP Server Configuration

Network	<input type="text" value="0.0.0.0"/>
Subnet Mask	<input type="text" value="0.0.0.0"/>
Default Gateway	<input type="text" value="0.0.0.0"/>
Lease Time(s)	<input type="text" value="804800"/>

#### Excluded Address

IP Address

#### Excluded Address List

Index	IP Address

#### Manual Binding

IP Address	<input type="text"/>
MAC Address	<input type="text"/>

#### Manual Binding List

Index	IP Address	MAC Address

#### Port and IP Address

Port	<input type="text"/>
IP Address	<input type="text"/>

Port	IP Address

#### Option82 IP Address Configuration

IP Address	<input type="text"/>
Circuit ID	<input type="text"/>
Remote ID	<input type="text"/>

IP Address	Circuit ID	Type	Remote ID	Type



<b>DHCP Server Configuration Page</b>	
DHCP Server	You can select to <b>Enable</b> or <b>Disable</b> the DHCP Server function. The ES8508 assigns a new IP address to link partners.
<b>DHCP Server Configuration</b>	
Network	Enter the IPv4 address for the DHCP server.
Subnet Mask	Enter the subnet mask for the DHCP server.
Default Gateway	Enter the IP gateway address for the DHCP server.
Lease Time	Enter the Lease Time in seconds for the client.
Apply	Click <b>Apply</b> to apply the settings. <b>Note:</b> You must <b>Save</b> the settings ( <a href="#">Page 129</a> ), if you want to maintain these settings if the ES8508 is powered off.
<b>Excluded Address</b>	
IP Address	You can type a specific address into the <b>IP Address field</b> for the DHCP server reserved IP address. The IP address that is listed in the <b>Excluded Address List Table</b> is not assigned to the network device. Add or remove an IP address from the <b>Excluded Address List</b> by clicking <b>Add</b> or <b>Remove</b> .
<b>Manual Binding</b>	
IP Address	The ES8508 provides an IP address binding and removing function. Enter the specified IP address, and then click <b>Add</b> to add a new IP address binding rule for a specified link partner, like a PLC, or any device without <b>DHCP client</b> function. To remove an IP address from the Manual Binding List, highlight the rule and click <b>Remove</b> .
MAC Address	The ES8508 provides a MAC address binding and removing function. Enter the specified MAC address, and then click <b>Add</b> to add a new MAC address binding rule for a specified link partner, like a PLC, or any device without <b>DHCP client</b> function. The MAC address format is <b>xxxx.xxxx.xxxx</b> ; for example, 00C0.4E3A.0001. To remove a MAC address from the Manual Binding List, highlight the rule and click <b>Remove</b> .
<b>Port and IP Address</b>	
Port	Enter the client port number for the DHCP server.
IP Address	Enter the client IP address for the DHCP server. After entering the port number and IP address, click <b>Add</b> . To remove a port and associated IP address, click <b>Remove</b> . Click <b>Reload</b> to reload selected port and IP address entries.
<b>Option82 IP Address Configuration</b>	
IP Address	Option 82 IP Address Configuration: fully supports DHCP relay function. The IP address of the Option82 IP address configuration.
Circuit ID	The Circuit ID of the Option82 IP address configuration.

DHCP Server Configuration Page (Continued)	
Remote ID	The Remote ID of the Option82 IP address configuration. After entering the IP Address, Circuit ID, and Remote ID, click <b>Add</b> . Click the <b>Remove</b> button to remove selected Option82 IP Address table entries. Click the <b>Reload</b> button to reload selected Option82 IP Address table entries.
Type	This displays string or hex, depending on the type.

### DHCP Leased Entries

---

The ES8508 provides an assigned IP address.

#### DHCP Leased Entries

Index	Binding	IP Address	MAC Address	Lease Time(s)

DHCP Leased Entries Page	
Index	Index of DHCP leased entries.
Binding	Manual or auto binding IP addresses and MAC addresses.
IP Address	The IP address of the leased entry.
MAC Address	The MAC Address of the leased entry.
Lease Time(s)	The lease time of the leased entry (in seconds).
Reload	Click to reload DHCP leased entries.

## DHCP Relay Agent

This subsection discusses the DHCP Relay Agent.

### DHCP Relay Agent

**Relay Agent**

**Relay Policy**

- Relay policy drop
- Relay policy keep
- Relay policy replace

Helper Address 1	<input type="text"/>
Helper Address 2	<input type="text"/>
Helper Address 3	<input type="text"/>
Helper Address 4	<input type="text"/>

### DHCP Option82 Relay Agent

**Circuit-ID:**  Default  Port    Circuit ID

**Remote-ID:**  Default  IP Address  Remote ID

Remote-ID:

Port	Circuit ID	Display

<b>DHCP Server Configuration Page</b>	
DHCP Server	You can select to <b>Enable</b> or <b>Disable</b> the DHCP Server function. The ES8508 assigns a new IP address to link partners.
<b>DHCP Server Configuration</b>	
Network	Enter the IPv4 address for the DHCP server.
Subnet Mask	Enter the subnet mask for the DHCP server.
Default Gateway	Enter the IP gateway address for the DHCP server.
Lease Time	Enter the Lease Time in seconds for the client.
Apply	Click <b>Apply</b> to apply the settings. <b>Note:</b> You must <b>Save</b> the settings ( <a href="#">Page 129</a> ), if you want to maintain these settings if the ES8508 is powered off.
<b>Excluded Address</b>	
IP Address	You can type a specific address into the <b>IP Address field</b> for the DHCP server reserved IP address. The IP address that is listed in the <b>Excluded Address List Table</b> is not assigned to the network device. Add or remove an IP address from the <b>Excluded Address List</b> by clicking <b>Add</b> or <b>Remove</b> .
<b>Manual Binding</b>	
IP Address	The ES8508 provides an IP address binding and removing function. Enter the specified IP address, and then click <b>Add</b> to add a new IP address binding rule for a specified link partner, like a PLC, or any device without <b>DHCP client</b> function. To remove an IP address from the Manual Binding List, highlight the rule and click <b>Remove</b> .
MAC Address	The ES8508 provides a MAC address binding and removing function. Enter the specified MAC address, and then click <b>Add</b> to add a new MAC address binding rule for a specified link partner, like a PLC, or any device without <b>DHCP client</b> function. The MAC address format is <b>xxxx.xxxx.xxxx</b> ; for example, 00C0.4E3A.0001. To remove a MAC address from the Manual Binding List, highlight the rule and click <b>Remove</b> .
<b>Port and IP Address</b>	
Port	Enter the client port number for the DHCP server.
IP Address	Enter the client IP address for the DHCP server. After entering the port number and IP address, click <b>Add</b> . To remove a port and associated IP address, click <b>Remove</b> . Click <b>Reload</b> to reload selected port and IP address entries.
<b>Option82 IP Address Configuration</b>	
IP Address	Option 82 IP Address Configuration: fully supports DHCP relay function. The IP address of the Option82 IP address configuration.
Circuit ID	The Circuit ID of the Option82 IP address configuration.

DHCP Server Configuration Page (Continued)	
Remote ID	The Remote ID of the Option82 IP address configuration. After entering the IP Address, Circuit ID, and Remote ID, click <b>Add</b> . Click the <b>Remove</b> button to remove selected Option82 IP Address table entries. Click the <b>Reload</b> button to reload selected Option82 IP Address table entries.
Type	This displays string or hex, depending on the type.

## Backup and Restore

You can use the **Backup** option to save the current configuration saved in the ES8508 flash to a PC/laptop or a TFTP server.

This allows you to use the **Restore** option to restore a configuration file back to the ES8508 or load the same settings to another ES8508. Before you can restore a configuration file, you must save the backup configuration file in the PC or TFTP server. The ES8508 then downloads this file back into the flash.

The ES8508 configuration file is a standard text file. You can open the file with Word or Notepad. You can also modify the file, add/remove the configuration settings, and then restore the file back to the ES8508.

There are two modes to backup and restore the configuration file:

- Local File
  - [Backup the Configuration - Local File Method](#) on Page 62
  - [Restore the Configuration - Local Method](#) on Page 63
- TFTP Server
  - [Backup the Configuration - TFTP Server Method](#) on Page 64
  - [Restore the Configuration - TFTP Server Method](#) on Page 67

You can use the **Local File** method if you have a Windows XP system.

If you have Windows Server 2003 through Windows 8, you must use the **TFTP Server** method to backup or restore configuration files.

**Note:** *PortVision DX also supports saving and loading configuration files, without any Windows operating system restrictions.*

### Backup and Restore

### Backup & Restore Page

Backup Configuration	<ul style="list-style-type: none"> <li>• <b>Local File:</b> The ES8508 acts as the file server in Windows XP. Other Windows operating systems must use the TFTP method. This mode is only provided by the web user interface as the backup and restore functions are not supported by the CLI. For procedures, see <a href="#">Backup the Configuration - Local File Method</a> on Page 62.</li> <li>• <b>TFTP Server:</b> The ES8508 acts as a TFTP client. This mode can be used in both the CLI and web user interface. For procedures, see <a href="#">Backup the Configuration - TFTP Server Method</a> on Page 64.</li> </ul> <p><b>Note:</b> <i>Pointing to the wrong file causes the entire configuration to be skipped.</i></p>
Backup	<b>Backup</b> can only backup the configuration file to your PC or a TFTP server.
Restore Configuration	You can select local file in Windows XP or TFTP server for all Windows operating systems to restore the startup configuration. For procedures, see <a href="#">Restore the Configuration - Local Method</a> on Page 63 or <a href="#">Restore the Configuration - TFTP Server Method</a> on Page 67.

Backup & Restore Page (Continued)	
Restore	Click to restore ES8508 startup configurations to the ES8508.
Backup Configuration	<ul style="list-style-type: none"> <li><b>Local File:</b> The ES9528 acts as the file server in Windows XP. Other Windows operating systems must use the TFTP method. This mode is only provided by the web user interface as the backup and restore functions are not supported by the CLI. For procedures, see <a href="#">Backup the Configuration - Local File Method</a>.</li> <li><b>TFTP Server:</b> The ES9528 acts as a TFTP client. This mode can be used in both the CLI and web user interface. For procedures, see <a href="#">Backup the Configuration - TFTP Server Method</a>.</li> </ul> <p><b>Note:</b> Pointing to the wrong file causes the entire configuration to be skipped.</p>

- The ES8508 provides a default configuration file in the ES8508. To load the default configuration file, you can use the **Reset** on the [Factory Defaults](#) page on [Page 69](#) or the **Reload** command in the CLI ([Page 150](#)).
- You can use the CLI to view the latest settings running in the ES8508. The information are the settings you have configured but have not yet saved to the flash. The settings must be saved to the flash in order to work after a power recycle. Use the **running-config** command to view the configuration file, see [Show Running Configuration](#) on Page 150.
- After you save the **running-config** to flash, the new settings are kept and work after the power is cycled. Use the **show startup-config** to view it in the CLI. The **Backup** command can only backup the configuration file to your PC or TFTP server.

*Backup the Configuration - Local File Method*

You can use **Local File** method to backup (or restore) with a Windows XP system.

**Note:** If you have a Windows Server 2003 through Windows 7 operating system, you must use the TFTP server method ([Page 64](#)). You can use PortVision DX which does not have any operating system restrictions.

- Open the web user interface for the ES8508 and open the **Backup and Restore** page under *Basic Settings*.
- Select **Local File** for **Backup Configuration**.
- Click the **Folder** icon, browse to the location that you want to store the backup configuration file, enter a file name, and click **Open**.

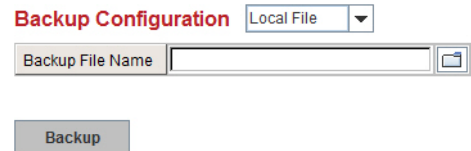

**Note:** You cannot use spaces in the path to the target file.

- Click the **Backup** button and then click **Ok** when the *Success Message* appears.

**Backup and Restore**

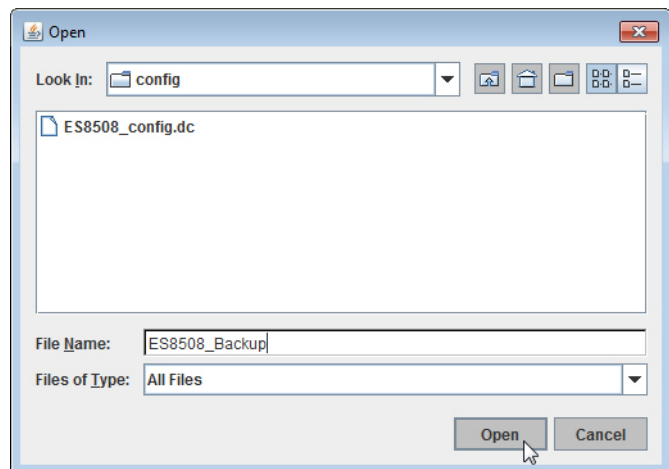
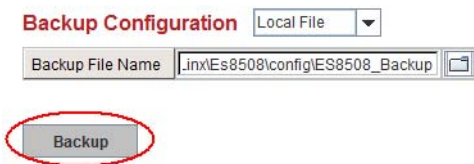

*Restore the Configuration - Local Method*

You can use **Local File** method to restore with a Windows XP system.

**Note:** *If you have a Windows Server 2003 through Windows 8 operating system, you must use the TFTP server method (Page 67) or use PortVision DX, which has no Windows operating system restrictions.*

1. Open the web user interface for the ES8508 and open the **Backup and Restore** page under *Basic Settings*.
2. Select **Local File** as the **Restore Configuration**.
3. Click the **Folder** icon, browse to the location where the backup configuration file is located., highlight the file, and click **Open**.

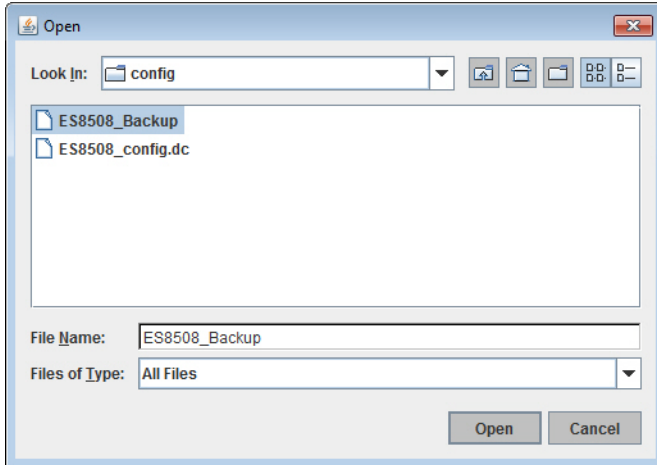
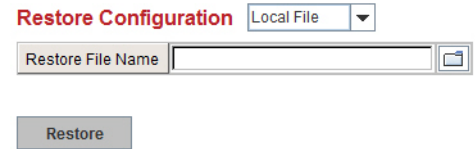

4. Click the **Restore** button.

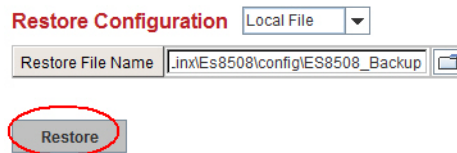

5. Click **Yes** to the *Confirm Dialog*.
6. Click **Ok** to the *Success Message*.

*Backup the Configuration - TFTP Server Method*

---

You must use a TFTP server to create or load backup files if you are using the following operating systems:

- Windows Server 2003
- Windows Vista
- Windows Server 2008
- Windows 7
- Windows Server 2012
- Windows 8

If you do not have a TFTP server, you can download one from Control using the [Start the TFTP Server](#) subsection. You need to disable the Windows firewall, you can use the procedures in [Disable the Windows Firewall](#) on Page 65. After opening a TFTP server and disabling you can do the following:

- [Backup the Configuration - TFTP Server Method](#) on Page 64
- [Restore the Configuration - TFTP Server Method](#) on Page 67

**Start the TFTP Server**

---

Use this procedure to download either the 32-bit or the 64-bit version from Control.

1. If necessary, download the appropriate .zip file for your operating system from: [ftp://ftp.control.com/contribs/free\\_3rd\\_party\\_utils/tftp\\_server/](ftp://ftp.control.com/contribs/free_3rd_party_utils/tftp_server/) to your system and unzip the file.
2. Execute the TFTP server application, click **Allow access**, and the TFTP server opens.
3. Leave the TFTP server open and go to the next subsection to temporarily disable the firewall.

*TFTP Server IP Address*

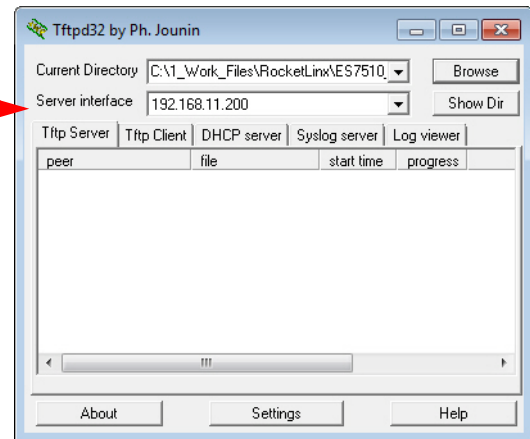



## Disable the Windows Firewall

Use the following procedure to temporarily disable the system firewall. This example uses Windows 7.

1. From the **Start** button, click **Control Panel**, and click **System and Security**.



2. Click **Windows Firewall**.

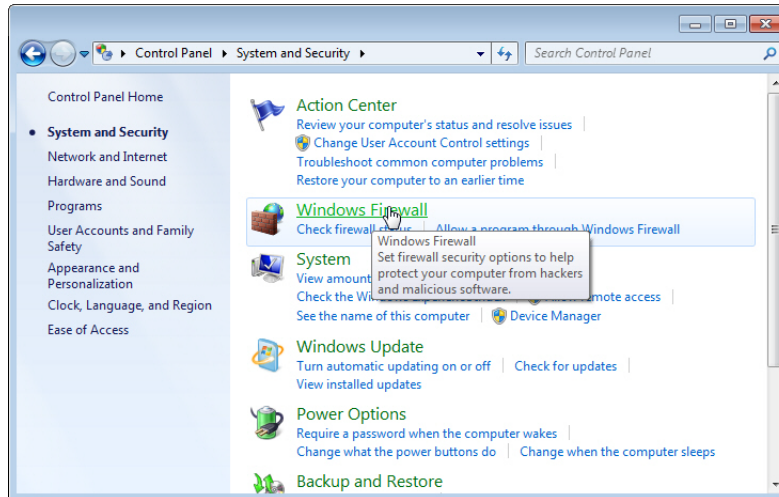

3. Click **Turn Windows Firewall on or off**.

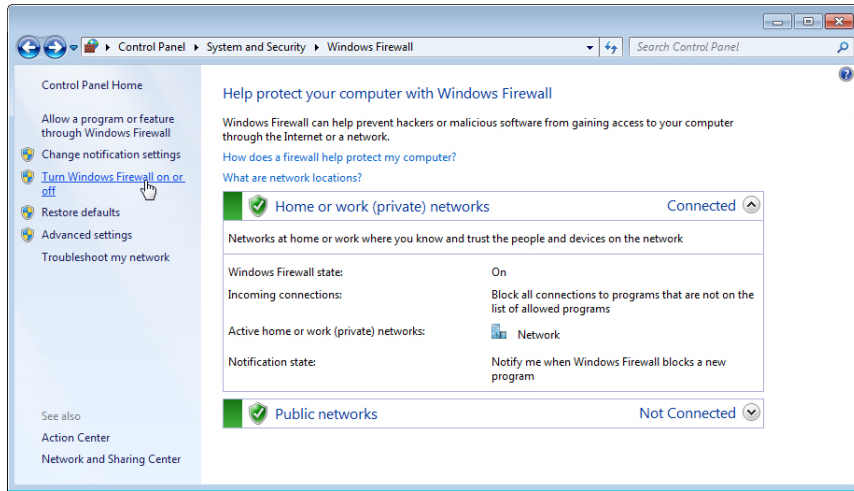

4. Click **Turn off Windows Firewall (not recommended)** for private and public networks and **Ok**.

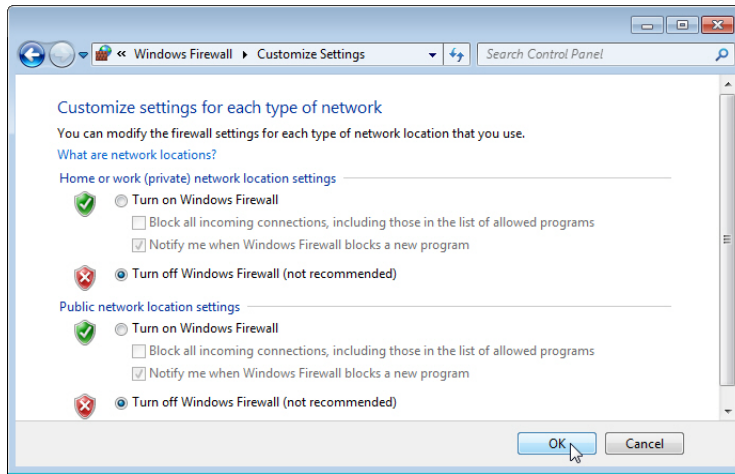

5. Minimize the **Control Panel** and go to the appropriate procedure, [Create a Backup File](#) on Page 66 or [Restore the Configuration - TFTP Server Method](#) on Page 67.

### Create a Backup File

You must have a TFTP server open and disabled the Windows firewall for this following procedure to work.

1. Open the web user interface for the ES8508 and open the **Backup and Restore** page under *Basic Settings*.
2. Select **TFTP Server** for the **Backup Configuration**, enter the IP address of the TFTP server, enter a **Backup File Name**, and click the **Backup** button.

**Note:** You cannot use spaces in the path to the target file.

3. Click **Ok** to close the popup message.

**Note:** Make sure that you enable your Windows firewall when you have completed these tasks.

The backup file is located in the same directory that the TFTP server resides.

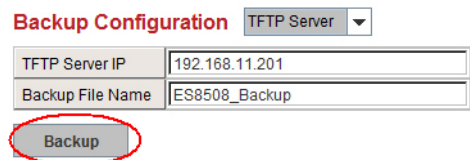

*Restore the Configuration - TFTP Server Method*

To restore a configuration file, you must open a TFTP server and disable the Windows firewall. If necessary, use [Start the TFTP Server](#) on Page 64 and [Disable the Windows Firewall](#) on Page 65.

The backup file must be located in the same directory that the TFTP server resides for this procedure to work.

1. Open the web user interface for the ES8508, open the **Backup and Restore** page under *Basic Settings*.
2. Select **TFTP Server** for the **Restore Configuration**, enter the IP address of the TFTP server, enter the **Backup File Name**, and click the **Restore** button.
3. Click **Yes** to the *Confirm Dialog* message.
4. Click **Ok** to the *Success Message*.

**Note:** Make sure that you enable your Windows firewall when you have completed these tasks.

**Firmware Upgrade**

Use this section to update the ES8508 with the latest firmware. Comtrol provides the latest firmware on the Comtrol [FTP site](#). Updated firmware may include new features, bug fixes, or other software changes. Comtrol Technical Support suggests you use the latest firmware before installing the ES8508 at a customer site.

**Note:** *Optionally, you can use PortVision DX to upload the latest firmware. If you need to upload a new version of the Bootloader, you must use PortVision DX. You cannot use the web user interface to upload the Bootloader.*

Firmware Upgrade Page	
System Firmware Version	The firmware version on the ES8508. You should check the version number after the switch reboots.
System Firmware Date	The build date of the firmware on the ES8508.
Firmware Upgrade	<ul style="list-style-type: none"> <li>• <b>Local File (Windows XP)</b> - see <a href="#">Upgrading Firmware (Local File)</a> on Page 68</li> <li>• <b>TFTP Server (Window Server 2003 - Windows 8)</b> - see <a href="#">Upgrading Firmware (TFTP Server)</a> on Page 69</li> </ul>

**Note:** *The system is automatically rebooted after you finish upgrading firmware. You should alert the attached users before updating the firmware that network interruption may occur.*

Upgrading Firmware (Local File)

You can use this procedure to upgrade the firmware (not Bootloader) using Windows XP.

1. Open the web user interface for the ES8508, open the **Firmware Upgrade** page under *Basic Settings*.
2. Select **Local** in the **Firmware Upgrade** drop list.
3. Click the **folder** icon, browse to the firmware location, highlight the **.bin** file, and click **Open**.

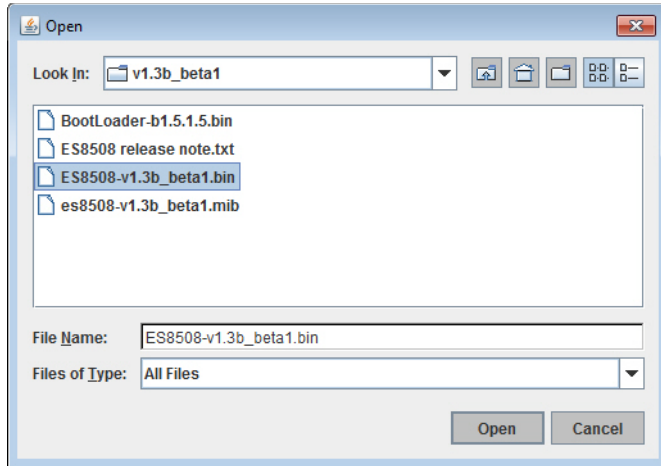

Firmware Upgrade

System Firmware Version: v1.3b\_beta1  
System Firmware Date: 20130816-10:01:36  
WebManager Build Date: 2013-08-16 10:13:54

Firmware Upgrade Local File

Firmware File Name

Note: When firmware upgrade is finished, the switch will restart automatically.

Upgrade

4. Click the **Upgrade** button.

Firmware Upgrade

System Firmware Version: v1.3b\_beta1  
System Firmware Date: 20130816-10:01:36  
WebManager Build Date: 2013-08-16 10:13:54

Firmware Upgrade Local File

Firmware File Name .3b\_beta1ES8508-v1.3b\_beta1.bin

Note: When firmware upgrade is finished, the switch will restart automatically.

Upgrade

5. Click **Yes** to the *Confirm Dialog* message.
6. Click **Ok** to the *Warning Message*.
7. Click **Ok** to close the *Success Message*.

**Note:** After the firmware has successfully uploaded, you should close and re-open the browser to clear the Java Virtual Machine cache.

### Upgrading Firmware (TFTP Server)

You can use this procedure to upgrade the firmware (not Bootloader) using a Windows operating systems.

1. Open a TFTP server, if necessary, see [Start the TFTP Server](#) on Page 64.
2. Place the ES8508 .bin file in the same directory where the TFTP server resides.
3. Disable the Windows firewall, if necessary, see [Disable the Windows Firewall](#) on Page 65.
4. If necessary, open the web user interface, open the **Firmware Upgrade** page in the *Basic Settings* group.
5. Select **TFTP Server** in the **Firmware Upgrade** drop list.
6. Enter the IP address of the TFTP server, enter the firmware file name, and click the **Upgrade** button.
7. Click **Yes** to the *Confirm Dialog* message.
8. Click **Ok** to the *Warning Message*.
9. Click **Ok** to close the *Success Message*.
10. Enable the Windows firewall.

**Note:** After the firmware has successfully uploaded, you should close and re-open the browser to clear the Java Virtual Machine cache.

### Factory Defaults

You can reset the ES8508 configuration values to default settings, excluding the network information. Optionally, you can use the [Reset Button](#) on Page 16, which also resets the IP address with the default configuration values.

**Note:** You can also use *PortVision DX* to reset the switch to the default configuration values (excluding the network settings.).

1. Click **Reset**, if you want the ES8508 to reset all configurations to factory default settings.  
The system displays a popup message window after finishing. The default settings work after rebooting the ES8508.
2. Click **Yes** in the popup message to reset the configuration to the factory defaults.
3. Click **OK** to the *Success Message*.
4. Go to the **Reboot** page, click the **Reboot** button.
5. Click **Yes** to reboot the ES8508.
6. Click **OK** to the *Success Message*.

### System Reboot

**System Reboot** allows you to reboot the device. Most feature changes require a switch reboot to take affect.

**Note:** Before rebooting, remember to click **Save** to save your settings. Otherwise, the settings you are lost when the ES8508 is powered off.

1. Click the **Reboot** button to reboot your ES8508.
2. Click **Yes**. The switch reboots immediately.
3. Click **Ok**.

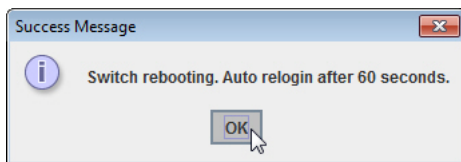

## Port Configuration

---

---

The *Port Configuration* group allows you to enable/disable port state, or configure port auto-negotiation, speed, duplex, flow control, port aggregation settings (port trunking), and rate limit control. It also allows you to view port status and aggregation information. The following pages are included in this group:

- [Port Control](#)
- [Port Status](#) on Page 72
- [Rate Control](#) on Page 73
- [Port Trunking](#) on Page 74

Optionally, you can use the CLI for configuration, see [Port Configuration \(CLI\)](#) on Page 152.

### Port Control

---

Port Control page allows you to enable/disable port state, or configure the port auto-negotiation, speed, duplex, and flow control.

#### Port Control

Port	State	Speed/Duplex	Flow Control	Description
1	Enable	Auto Negotiation	Disable	
2	Enable	Auto Negotiation	Disable	
3	Enable	Auto Negotiation	Disable	
4	Enable	Auto Negotiation	Disable	
5	Enable	Auto Negotiation	Disable	
6	Enable	Auto Negotiation	Disable	
7	Enable	Auto Negotiation	Disable	
8	Enable	Auto Negotiation	Disable	

Apply

***ES8508F and ES8508F-XT:***

*Ports 7 and 8 support 100 Full.*

Select the port you want to configure and make changes to the port. The following table provides information about the different port control options.

Port Configuration Page	
State	You can enable or disable the state of this port. Once you click <b>Disable</b> , the port stops to link to the other end and stops to forward any traffic. The default setting is <b>Enable</b> which means all the ports are workable when you receive the ES8508.
Speed/Duplex	<p>You can configure port speed and duplex mode of each port. Below are the selections you can choose:</p> <p><b>ES8508:</b></p> <ul style="list-style-type: none"> <li>• Fast Ethernet Ports 1~ 8 (fa1~fa8) <ul style="list-style-type: none"> <li>- Auto Negotiation (default)</li> <li>- 10M full-duplex (10 Full)</li> <li>- 10M half-duplex (10 Half)</li> <li>- 100M full-duplex (100 Full)</li> <li>- 100M half-duplex (100 Half)</li> </ul> </li> </ul> <p><b>ES8508F:</b></p> <ul style="list-style-type: none"> <li>• Fast Ethernet Ports 1~ 6 (fa1~fa6) <ul style="list-style-type: none"> <li>- Auto Negotiation (default)</li> <li>- 10M full-duplex (10 Full)</li> <li>- 10M half-duplex (10 Half)</li> <li>- 100M full-duplex (100 Full)</li> <li>- 100M half-duplex (100 Half)</li> </ul> </li> <li>• Fast Ethernet Ports 7~ 8 (fa7~fa8) <ul style="list-style-type: none"> <li>- 100M full-duplex (100 Full)</li> </ul> </li> </ul>
Flow Control	<p><b>Symmetric</b> means that you need to activate the flow control function of the remote network device in order to let the flow control of that corresponding port on the switch to work.</p> <p><b>Disable</b> (default) means that you do not need to activate the flow control function of the remote network device, as the flow control of that corresponding port on the switch works.</p>
Description	Click this field if you want to enter a port description.
Apply	<p>Click <b>Apply</b> to apply the settings.</p> <p><b>Note:</b> You must <b>Save</b> the settings (<a href="#">Page 129</a>), if you want to maintain these settings if the ES8508 is powered off.</p>

*Technical Tip:*

If both ends are not at the same speed, they cannot link with each other. If both ends are not in the same duplex mode, they are connected by half-duplex mode.



## Port Status

The Port Status page displays the current port status.

### Port Status

Port	Type	Link	State	Speed/Duplex	Flow Control
1	100BASE	Down	Enable	--	Disable
2	100BASE	Down	Enable	--	Disable
3	100BASE-TX	Up	Enable	100 Full	Disable
4	100BASE	Down	Enable	--	Disable
5	100BASE	Down	Enable	--	Disable
6	100BASE	Down	Enable	--	Disable
7	100BASE-FX	Down	Enable	100 Full	Disable
8	100BASE-FX	Up	Enable	100 Full	Disable

*This image displays the ES8508F or ES8508F-XT.*

Port Status Page	
Type	100BASE-TX or 100BASE-FX displays for Fast Ethernet ports, depending on the port type.
Link	Shows link status; Up means the link is up and Down means that the link is down.
State	Shows the port state. If the state is enabled it displays <b>Enable</b> . If the port is disabled or shutdown, it displays <b>Disable</b> .
Speed/Duplex	Current working status of the port.
Flow Control	The state of the flow control.



## Rate Control

Rate limiting is a form of flow control used to enforce a strict bandwidth limit at a port. You can program separate transmit (Egress Rule) and receive (Ingress Rule) rate limits at each port, and even apply the limit to certain packet types as described below.

### Rate Control

#### Limit Packet Type and Rate

Port	Ingress Packet Type	Ingress Rate(Mbps)	Egress Packet Type	Egress Rate(Mbps)
1	Broadcast Only	8	All	0
2	Broadcast Only	8	All	0
3	Broadcast Only	8	All	0
4	Broadcast Only	8	All	0
5	Broadcast Only	8	All	0
6	Broadcast Only	8	All	0
7	Broadcast Only	8	All	0
8	Broadcast Only	8	All	0

Apply

Rate Control Page	
Ingress Packet Type	<p>You can select the packet type that you want to filter. The Ingress packet types supported are:</p> <ul style="list-style-type: none"> <li>Broadcast/Multicast/Unknown Unicast</li> <li>Broadcast/Multicast</li> <li>Broadcast</li> <li>All</li> </ul> <p>The Egress rate supports all types of packets.</p>
Bandwidth	<p>All ports support port Ingress and Egress rate control. For example, assume Port 1 is 10Mbps, you can set it's effective Egress rate at 2Mbps, Ingress rate at 1Mbps. The ES8508 performs the Ingress rate by packet counter to meet the specified rate.</p> <ul style="list-style-type: none"> <li>Ingress Ingress rate in Mbps, the rate range is from 1 Mbps to 100 Mbps and zero means no limit. The default value is 8Mbps</li> <li>Egress The default value is <b>no-limit</b>. Egress rate limiting has an effect on all types of packets, including Unicast, Multicast and Broadcast packets.</li> </ul>
Apply	<p>Click <b>Apply</b> to apply the settings.</p> <p><b>Note:</b> You must <b>Save</b> the settings (<a href="#">Page 129</a>), if you want to maintain these settings if the ES8508 is powered off.</p>

## Port Trunking

Port Trunking allows you to group multiple Ethernet ports in parallel to increase link bandwidth. The aggregated ports can be viewed as a physical port that has a bandwidth equal to the combined bandwidth of each trunked port. The member ports of the same trunk group can balance the loading and backup for each other. The Port Trunking feature is usually used when you need higher bandwidth for the network backbone. This is an inexpensive way for you to transfer more data.

The aggregated ports can interconnect to the another switch that also supports Port Trunking. Control supports two types of port trunking:

- Static Trunk
- IEEE 802.3ad

There are some different descriptions for the port trunking. Different manufacturers may use different descriptions for their products, like Link Aggregation Group (LAG), Link Aggregation Control Protocol, Ethernet Trunk, or Ether Channel.

When the other end uses IEEE 802.3ad LACP, you should assign IEEE 802.3ad LACP to the trunk. When the other end uses non-802.3ad, you can then use Static Trunk.

There are two pages for port trunking, [Aggregation Setting](#) on Page 74 and [Aggregation Status](#) on Page 75.



### Aggregation Setting

Use the *Port Trunk - Aggregation Setting* page to set up port trunking.

#### Port Trunk - Aggregation Setting

Port	Group ID	Trunk Type
1	None	Static
2	None	Static
3	None	Static
4	None	Static
5	None	Static
6	None	Static
7	None	Static
8	None	Static

Note: The port parameters of the trunk members should be the same.

Apply

Aggregation Setting Page	
Trunk Size	The ES8508 can support up to 8 trunk groups . Each trunk group can aggregate up to 8 members. The ports should use the same speed and duplex.
Group ID	<b>Group ID</b> is the ID for the port trunking group. Ports with same group ID are in the same group.
Trunk Type	<b>Static</b> or <b>802.3ad LACP</b> . Each trunk group can only support <b>Static</b> or <b>802.3ad LACP</b> . Non-active ports cannot be setup here.
Apply	Click <b>Apply</b> to apply the settings. <b>Note:</b> You must <b>Save</b> the settings ( <a href="#">Page 129</a> ), if you want to maintain these settings if the ES8508 is powered off.

Aggregation Status

The *Port Trunk - Aggregation Information* page shows the status of port aggregation. Once the aggregation ports are negotiated, you see the following status.

Port Trunk - Aggregation Information

Group ID	Type	Aggregated Ports	Individual Ports	Link Down Ports
Trunk 1				
Trunk 2				
Trunk 3				
Trunk 4				
Trunk 5				
Trunk 6				
Trunk 7				
Trunk 8				

Reload

Aggregation Status Page	
Group ID	Displays Trunk 1 to Trunk 8 set up.
Type	The Type is <b>Static</b> or <b>LACP</b> . Static means that LACP is disabled and configured statically by the Administrator.
Aggregated Ports	When LACP links, you can see the member ports in the <b>Aggregated</b> column.
Individual Ports	When <b>LACP</b> is enabled, member ports of LACP group that are not connected to the correct LACP member ports are displayed in the <b>Individual</b> column.
Link Down Ports	When <b>LACP</b> is enabled, member ports of LACP group that are not linked up are displayed in the <b>Link Down</b> column.
Reload	Click <b>Reload</b> to reload aggregation settings.

## Network Redundancy

---

---

It is critical for industrial applications that the network remains running at all times. The ES8508 supports:

- Standard Rapid Spanning Tree Protocol (STP) and Rapid Spanning Tree Protocol (RSTP)  
The ES8508 supports RSTP versions IEEE 802.1D-2004, IEEE 802.1D-1998 STP, and IEEE 802.1w RSTP.
- Multiple Spanning Tree Protocol (MSTP)  
MSTP implements IEEE 802.1s, which uses RSTP for rapid convergence, enables VLANs to be grouped into a spanning-tree instance, with each instance having a spanning-tree topology independent of other spanning-tree instances. This architecture provides multiple forwarding paths for data traffic, enables load balancing, and reduces the number of spanning-tree instances required to support a large number of VLANs. MSTP was originally defined in the IEEE 802.1s and later merged into the IEEE 802.1Q-2003 specification.
- Redundant Ring  
The Redundant Ring features 0 ms for restore and less than 5 ms for fail over for copper.
- Rapid Dual Homing (RDH)  
Advanced RDH technology allows the ES8508 to connect with a core managed switch easily. With RDH technology, you can also couple several Rapid Super Rings or RSTP groups together, which is also known as Auto Ring Coupling.

The following pages are included in this group:

- [STP Configuration](#) on Page 77
- [STP Port Configuration](#) on Page 78
- [STP Information](#) on Page 79
- [MSTP Configuration](#) on Page 81
- [MSTP Port Configuration](#) on Page 83
- [MSTP Information](#) on Page 84
- [Redundant Ring](#) on Page 86
- [Redundant Ring Information](#) on Page 87
- [Loop Protection](#) on Page 88

Optionally, you can use the CLI to configure these features, see [Network Redundancy \(CLI\)](#) on Page 155.

## STP Configuration

This page allows you to select the STP mode and configure the global STP/RSTP bridge configuration. Spanning Tree Protocol (STP; IEEE 802.1D) provides a loop-free topology for any LAN or bridged network.

Rapid Spanning Tree Protocol (RSTP; IEEE 802.1w) is an evolution of the Spanning Tree Protocol (STP), and was introduced with the IEEE 802.1w standard, and provides faster spanning tree convergence after a topology change. In most cases, IEEE 802.1w can also revert back to IEEE 802.1D in order to interoperate with legacy bridges on a per-port basis. The new edition of the IEEE 802.1D standard, IEEE 802.1D-2004, incorporates the IEEE 802.1t-2001 and IEEE 802.1w standards.

Multiple Spanning Tree Protocol (MSTP; IEEE 802.1s) which uses RSTP for rapid convergence, enables VLANs to be grouped into a spanning-tree instance, with each instance having a spanning-tree topology independent of other spanning-tree instances. This architecture provides a loop-free topology with load balancing while reducing the number of spanning-tree instances required to support a large number of VLANs. MSTP was originally defined in the IEEE 802.1s and later merged into the IEEE 802.1Q-2003 specification.

### STP Configuration

**STP Mode**

#### Bridge Configuration

Bridge Address	00c0.4e3a.000d
Bridge Priority	32768
Max Age	20
Hello Time	2
Forward Delay	15

### STP Configuration Page

STP Mode	Select STP running protocol STP, RSTP or MSTP or disable STP.
<b>Bridge Configuration</b>	
Bridge Address	A value used to identify the bridge. This item cannot be modified.
Bridge Priority	A value used to identify the bridge. The bridge with the lowest value has the highest priority and is selected as the root. Enter a number 0 through 61440 in increments of 4096.
Max Age	The number of seconds a bridge waits without receiving Spanning-Tree Protocol configuration messages before attempting to reconfigure. Enter a number of 6 through 40. <b>Note:</b> $2 * (\text{Forward Delay Time} - 1)$ should be greater than or equal to the Max Age. The Max Age should be greater than or equal to $2 * (\text{Hello Time} + 1)$ .
Hello Time	The number of seconds between the transmissions of Spanning-Tree Protocol configuration messages. Enter a number of 1 through 10. <b>Note:</b> $2 * (\text{Forward Delay Time} - 1)$ should be greater than or equal to the Max Age. The Max Age should be greater than or equal to $2 * (\text{Hello Time} + 1)$ .
Forward Delay	The number of seconds a port waits before changing from its Spanning-Tree Protocol learning and listening states to the forwarding state. Enter a number 4 through 30. <b>Note:</b> $2 * (\text{Forward Delay Time} - 1)$ should be greater than or equal to the Max Age. The Max Age should be greater than or equal to $2 * (\text{Hello Time} + 1)$ .
Apply	Click <b>Apply</b> to apply the settings. <b>Note:</b> You must <b>Save</b> the settings ( <a href="#">Page 129</a> ), if you want to maintain these settings if the ES8508 is powered off.

## STP Port Configuration

This page allows you to configure the port parameter after you have enabled STP, RSTP, or MSTP.

### STP Port Configuration

Port	STP State	Path Cost	Priority	Link Type	Edge Port
1	Enable	200000	128	Auto	Enable
2	Enable	200000	128	Auto	Enable
3	Enable	200000	128	Auto	Enable
4	Enable	200000	128	Auto	Enable
5	Enable	200000	128	Auto	Enable
6	Enable	200000	128	Auto	Enable
7	Enable	200000	128	Auto	Enable
8	Enable	200000	128	Auto	Enable

STP Port Configuration Page	
STP State	You can enable/disable STP/RSTP/MSTP on a port by port basis. You can disable the STP state when connecting a device in order to avoid STP waiting periods.
Path Cost	The cost of the path to the other bridge from this transmitting bridge at the specified port. Enter a number from 1 through 200000000.
Priority	Decide which port should be blocked by priority on your LAN. Enter a number from 0 through 240 in increments of 16.
Link Type	Some of the rapid state transactions that are possible within RSTP are dependent upon whether the port in question is connected to exactly one other bridge (that is, it is served by a point-to-point LAN segment), or if it is connected to two or more bridges (that is., it is served by a shared medium LAN segment). This configuration allows the p2p status of the link to be controlled by an administrator.
Edge Port	Present in implementations that support the identification of edge ports. All ports directly connected to end stations cannot create bridging loops in the network and can thus directly transition to forwarding, and skipping the listening and learning stages. When a non-bridge device connects an edge port, this port is in a blocking state and turn to forwarding state in 2*Hello Time seconds. When the bridge device connects an edge port, this port is a non-edge port automatic.
Apply	Click <b>Apply</b> to apply the settings. <b>Note:</b> You must <b>Save</b> the settings ( <a href="#">Page 129</a> ), if you want to maintain these settings if the ES8508 is powered off.

## STP Information

The *STP Information* page allows you to see the ES8508 root information and port status.

### STP Information

#### Root Information

Root Address	0014.7c42.3aa0
Root Priority	32768
Root Port	5
Root Path Cost	400000
Max Age	20 second(s)
Hello Time	2 second(s)
Forward Delay	15 second(s)

#### Port Information

Port	Role	Port State	Path Cost	Port Priority	Link Type	Edge Port	Aggregated(ID/Type)
1	--	--	200000	128	P2P	Edge	/
2	Alternate	Blocking	200000	128	P2P	Non-Edge	/
3	--	--	200000	128	P2P	Edge	/
4	--	--	200000	128	P2P	Edge	/
5	Root	Forwarding	200000	128	P2P	Non-Edge	/
6	--	--	200000	128	P2P	Edge	/
7	--	--	200000	128	P2P	Edge	/
8	--	--	200000	128	P2P	Edge	/

Reload

### STP Information Page

#### Root Information

Root Address	Root bridge address, which is the bridge with the smallest (lowest) bridge ID.
Root Priority	Root bridge priority, the bridge with the lowest value has the highest priority and is selected as the root.
Root Port	Root port of this bridge.
Root Path Cost	Root path cost.
Max Age	The number of seconds a bridge waits without receiving Spanning-Tree Protocol configuration messages before attempting to reconfigure.
Hello Time	The number of seconds between the transmissions of Spanning-Tree Protocol configuration messages.
Forward Delay	The number of seconds a port waits before changing from its Spanning-Tree Protocol learning and listening states to the forwarding state.

STP Information Page (Continued)	
Port Information	
Port Role	Descriptive information about the STP/RSTP switch port role. Role: Root, Designated, Alternate, Backup, Disabled, Unknown.
Port State	Descriptive information about the STP/RSTP switch port state. State: Blocking, Listening, Learning, Forwarding, Disabled, Unknown.
Path Cost	The cost of the path to the other bridge from this transmitting bridge at the specified port. Path cost range is 1 through 200000000.
Port Priority	Decide which port should be blocked by priority in your LAN. Range is 0 through 240 in increments of 16.
Link Type	Operational link type. Some of the rapid state transactions that are possible within RSTP are dependent upon whether the port in question can be concerned to exactly one other bridge (that is, it is served by a point-to-point LAN segment), or can be connected to two or more bridges (that is, it is served by a shared medium LAN segment).
Edge Port	Operational edge port state. Present in implementations that support the identification of edge ports. All ports directly connected to end stations cannot create bridging loops in the network and can thus directly transition to forwarding, skipping the listening and learning stages. When the non-bridge device connects an edge port, this port is in blocking state and turn to forwarding state in 2*Hello Time seconds. When the bridge device connects an edge port, this port is a non-edge port automatic.
Reload	Click the <b>Reload</b> button to reload STP information.



## MSTP Configuration

Multiple Spanning Tree Protocol (MSTP) is a direct extension of RSTP. It can provide an independent spanning tree for different VLANs. It simplifies network management, creates a faster convergence than RSTP by limiting the size of each region, and prevents VLAN members from being segmented from the rest of the group (as sometimes occurs with IEEE 802.1D STP).

While using MSTP, there are some new concepts of network architecture. A switch may belong to different groups, act as root or designate switch, or generate BPDU packets for the network to maintain the forwarding table of the spanning tree. MSTP can also provide load balancing between switches.

One VLAN can be mapped to a Multiple Spanning Tree Instance (MSTI). The maximum number of instances that the ES8508 supports is 16, with a range from 0-15. The MSTP builds a separate Multiple Spanning Tree (MST) for each instance to maintain connectivity among each of the assigned VLAN groups. An Internal Spanning Tree (IST) is used to connect all the MSTP switches within an MST region. An MST Region may contain multiple MSTP instances.

The following figure shows a MSTP instance with two VLANs. Each instance has a root node and forwarding paths.

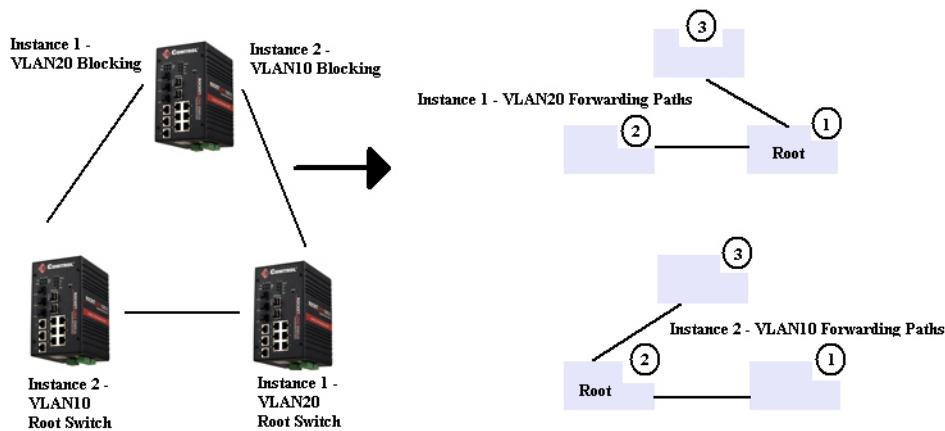

A Common Spanning Tree (CST) interconnects all adjacent MST regions and acts as a virtual bridge node for communications with STP or RSTP nodes in the global network. MSTP connects all bridges and LAN segments with a single Common Internal Spanning Tree (CIST). The CIST is formed as a result of the running spanning tree algorithm between switches that support the STP, RSTP, or MSTP protocols.

The following diagram shows a CST attached to a larger network. In this network, a Region may have different instances and its own forwarding path and table, however, the CST acts as a single bridge.

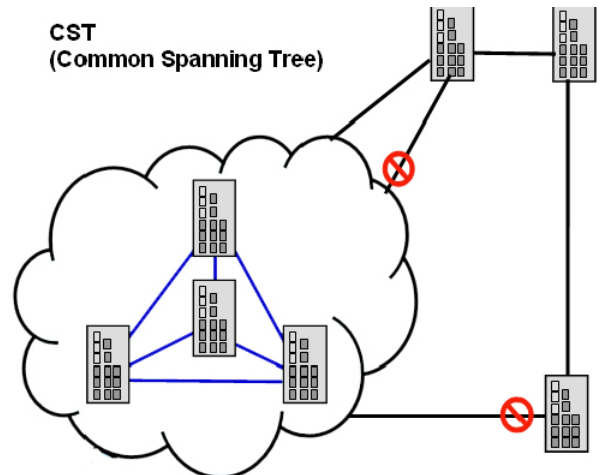

This is the *MSTP Configuration* page.

### MSTP Configuration

#### MST Region Configuration

Region Name	<input type="text"/>
Revision	<input type="text" value="0"/>

#### New MST Instance

Instance ID	<input type="text" value="1"/>
VLAN Group	<input type="text"/>
Instance Priority	<input type="text" value="32768"/>

#### Current MST Instance Configuration

Instance ID	VLAN Group	Instance Priority

<b>MSTP Configuration Page</b>	
<b>MST Region Configuration</b>	
Region Name	A name used to identify the MST Region.
Revision	A value used to identify the MST Region.
Apply	Click the <b>Apply</b> button to apply the MST Region Configuration.
<b>New MST Instance</b>	
Instance ID	A value used to identify the MST instance, valid value are 1 through 15. Instance 0 (CIST, Common Internal Spanning Tree) is a special instance of spanning-tree known as IST or Internal Spanning Tree (=MSTI00).
VLAN Group	Give a VLAN group to map this MST instance. Use a VLAN number (for example, 10), range (for example:1-10) or mixing format (for example: 2,4,6,4-7,10).
Instance Priority	A value used to identify the MST instance. The MST instance with the lowest value has the highest priority and is selected as the root. Enter a number 0 through 61440 in increments of 4096.
Add	Click the <b>Add</b> button to add the New MST Instance.

MSTP Configuration Page (Continued)	
Current MST Instance Configuration	
Instance ID	A value used to identify the MST instance. Instance 0 (CIST, Common Internal Spanning Tree) is a special instance of spanning-tree known as IST or Internal Spanning Tree (=MSTI00).
VLAN Group	Provide a VLAN group to map this MST instance. Use the VLAN number, for example: 10. You can set a range, for example: 1-10) or set specific VLANs, for example: 2,4,6,4-7.
Instance Priority	A value used to identify the MST instance. The MST instance with the lowest value has the highest priority and is selected as the root. Enter a number 0 through 61440 in increments of 4096.
Modify	Click the <b>Modify</b> button to apply the current MST instance configuration. <b>Note:</b> You must <b>Save</b> the settings ( <a href="#">Page 129</a> ), if you want to maintain these settings if the ES8508 is powered off.

### MSTP Port Configuration

This page allows you to configure the port settings. Choose the Instance ID that you want to configure.

#### MSTP Port Configuration

Instance ID

Port	Path Cost	Priority	Link Type	Edge Port

Apply

MSTP Port Configuration Page	
Instance ID	Select an Instance ID to display and modify MSTP instance setting.
Port Configuration	
Path Cost	The cost of the path to the other bridge from this transmitting bridge at the specified port. Enter a number from 1 through 200000000.
Priority	Decide which port should be blocked by priority on your LAN. Enter a number from 0 through 240 in increments of 16.
Link Type	Some of the rapid state transactions that are possible within RSTP are dependent upon whether the port in question is connected to exactly one other bridge (that is, it is served by a point-to-point LAN segment), or if it's connected to two or more bridges (that is, it is served by a shared medium LAN segment). This configuration allows the p2p status of the link to be controlled by an administrator.

MSTP Port Configuration Page (Continued)	
Edge Port	Present in implementations that support the identification of edge ports. All ports directly connected to end stations cannot create bridging loops in the network and can thus directly transition to forwarding, and skipping the listening and learning stages. When the non-bridge device connects an edge port, this port is in a blocking state and turn to forwarding state in 2*Hello Time seconds. When the bridge device connects an edge port, this port is a non-edge port automatic.
Apply	Click the <b>Apply</b> button to apply the configuration. <b>Note:</b> You must <b>Save</b> the settings ( <a href="#">Page 129</a> ), if you want to maintain these settings if the ES8508 is powered off.

### MSTP Information

This page allows you to see the current MSTP information. Choose the Instance ID first. If the instance is not added, the information remains blank.

#### MSTP Information

Instance ID  ▼

#### Root Information

Root Address	--
Root Priority	--
Root Port	--
Root Path Cost	--
Max Age	--
Hello Time	--
Forward Delay	--

#### Port Information

Port	Role	Port State	Path Cost	Port Priority	Link Type	Edge Port

Reload

<b>MSTP Information Page</b>	
Instance ID	Select an instance ID to display MSTP instance information. Instance 0 (CIST, Common Internal Spanning Tree) is a special instance of spanning-tree known as IST or Internal Spanning Tree (=MSTI00).
<b>Root Information</b>	
Root Address	Root bridge address, which is the bridge with the smallest (lowest) bridge ID.
Root Priority	Root bridge priority, the bridge with the lowest value has the highest priority and is selected as the root.
Root Port	Root port of this bridge.
Root Path Cost	Root path cost.
Max Age	The number of seconds a bridge waits without receiving Spanning-Tree Protocol configuration messages before attempting to reconfigure.
Hello Time	The number of seconds between the transmissions of Spanning-Tree Protocol configuration messages.
Forward Delay	The number of seconds a port waits before changing from its Spanning-Tree Protocol learning and listening states to the forwarding state.
<b>Port Information</b>	
Port Role	Descriptive information about the MSTP switch port role. Role: Master, Root, Designated, Alternate, Backup, Boundary, Disabled, Unknown.
Port State	Descriptive information about the MSTP switch port state. State: Blocking, Listening, Learning, Forwarding, Disabled, Unknown.
Path Cost	The cost of the path to the other bridge from this transmitting bridge at the specified port. Path cost range is 1 through 200000000.
Port Priority	Decide which port should be blocked by priority in your LAN. The range is 0 through 240 in increments of 16.
Link Type	Operational link type. Some of the rapid state transactions that are possible within MSTP are dependent upon whether the port in question can be concerned to exactly one other bridge (that is, it is served by a point-to-point LAN segment), or can be connected to two or more bridges (that is, it is served by a shared medium LAN segment).
Edge Port	Operational edge port state. Present in implementations that support the identification of edge ports. All ports directly connected to end stations cannot create bridging loops in the network and can thus directly transition to forwarding, skipping the listening and learning stages. When the non-bridge device connects an edge port, this port is in blocking state and turn to forwarding state in 2*Hello Time seconds. When the bridge device connects an edge port, this port is a non-edge port automatic.
Reload	Click the <b>Reload</b> button to reload MSTP instance information.

## Redundant Ring

The most common industrial network redundancy is to form a ring or loop. Typically, managed switches are connected in series and the last switch is connected back to the first one. In such connection, you can implement Redundant Ring technology.

### Redundant Ring

#### New Ring

Ring ID	Name
<input type="text"/>	<input type="text"/>
<input type="button" value="Add"/>	

#### Ring Configuration

ID	Name	Version	Device Priority	Ring Port1	Path Cost	Ring Port2	Path Cost	Rapid Dual Homing	Ring Status
<div style="border: 1px solid gray; width: 100%; height: 100%;"></div>									
<input type="button" value="Apply"/>		<input type="button" value="Remove"/>		<input type="button" value="Reload"/>					

Redundant Ring Page	
New Ring (Ring ID/Name)	<p>To create a Redundant Ring enter the Ring ID, which has range from 0 to 31. If the name field is left blank, the name of this ring is automatically named with the Ring ID. The maximum number of rings is 32.</p> <p><b>Note:</b> Once a ring is created, you cannot change it.</p>
Ring Configuration	
ID	Once a Ring is created, the Ring ID appears, and cannot be changed. In multiple ring environments, the traffic can only be forwarded under the same Ring ID. Remember to check the Ring ID when there are more than one ring in existence.
Name	This field shows the name of the Ring. If it is not entered when creating, it is automatically named by the rule <i>RingID</i> .
Version	The version of Ring can be changed here, the choices are <b>Rapid Super Ring</b> or <b>Super Ring</b> .
Device Priority	The switch with highest priority (highest value) is automatically selected as the <b>Ring Master (RM)</b> . When one of the ring ports on this switch becomes a forwarding port and the other one becomes a blocking port. If all of the switches have the same priority, the switch with the highest MAC address is selected as the Ring Master.
Ring Port1	In a <b>Rapid Super Ring</b> environment, you should have two Ring ports. Whether this switch is a Ring Master or not. When configuring <b>Rapid Super Rings</b> , two ports should be selected to be Ring ports. For a Ring Master, one of the Ring Ports becomes the forwarding port and the other one becomes the blocking port.
Path Cost	Change the Path Cost of Ring Port1, if this switch is the Ring Master of a Ring, then it determines the blocking port. The port with higher Path Cost in the two Ring Ports becomes the blocking port. If the Path Cost is the same, the port with larger port number becomes the blocking port.
Ring Port2	Assign another port for ring connection.
Path Cost	Change the Path Cost of Ring Port2.

Redundant Ring Page (Continued)	
Rapid Dual Homing	<p>Rapid Dual Homing is an important feature of Rapid Super Ring redundancy technology. When you want to connect multiple RSR or form redundant topology with other vendors, RDH allows you to have a maximum of seven multiple links for redundancy without any problem.</p> <p>In RDH, you do not need to configure a specific port to connect to other protocol. The RDH selects the fastest link for the primary link and blocks all the other links to avoid a loop. If the primary link failed, RDH automatically forwards the secondary link for a network redundant. If there are more connections, they are standby links and are recovered if both primary and secondary links are broken.</p>
Ring status	To <b>Enable/Disable</b> the Ring, remember to enable the Ring after you add it.
Apply	<p>Click <b>Apply</b> to apply the settings.</p> <p><b>Note:</b> You must <b>Save</b> the settings (<a href="#">Page 129</a>), if you want to maintain these settings if the ES8508 is powered off.</p>

### Redundant Ring Information

This page shows Redundant Ring information.

#### Redundant Ring Information

ID	Version	Role	Status	RM MAC	Blocking Port	Role Transition Count	Ring State Transition Count

Redundant Ring Information Page	
ID	The Ring ID.
Version	Displays the ring version, this field could be Super Ring or Rapid Super Ring.
Role	This ES8508 is the RM (Ring Master) or nonRM (non-ring master).
Status	If this field is <b>Normal</b> it means the redundancy is approved. If any one of the link in this Ring is broken, then the status is <b>Abnormal</b> .
RM MAC	The MAC address of Ring Master of this Ring. It helps to find the redundant path.
Blocking Port	Shows which is blocked port of RM.
Role Transition Count	Shows how many times this ES8508 has changed its Role from nonRM to RM or from RM to nonRM.
Role state Transition Count	Shows how many times the Ring status has been transformed between <b>Normal</b> and <b>Abnormal</b> state.
Reload	Click to reload redundant ring information.

## Loop Protection

Loop protection prevents broadcast loops in Layer 2 switching configurations.

### Loop Protection

Transmit Interval

Port	Loop Protection	Status
1	Disable	--
2	Disable	--
3	Disable	--
4	Disable	--
5	Disable	--
6	Disable	--
7	Disable	--
8	Disable	--

Loop Protection Page	
Transmit Interval	Loop protection mechanism detection packet transmitting interval 1 ~ 10 seconds (default is 1).
Port	The port ID.
Loop Protection	Enable/Disable loop protection mechanism on port.
Status	The status of loop protection.
Apply	Click <b>Apply</b> to apply the settings. <b>Note:</b> You must <b>Save</b> the settings ( <a href="#">Page 129</a> ), if you want to maintain these settings if the ES8508 is powered off.
Enable/Disable All	Click the <b>Enable/Disable All</b> button to enable or disable all ports and then click <b>Apply</b> button to apply.
Reload	Click the <b>Reload</b> button to reload loop protection information.



## VLAN

A Virtual LAN (VLAN) is a logical grouping of nodes for the purpose of limiting a broadcast domain to specific members of a group without physically grouping the members. The VLAN allows you to isolate network traffic so that only members of the VLAN could receive traffic from the same VLAN members. Basically, creating a VLAN from a switch is the logical equivalent of physically reconnecting a group of network devices to another Layer 2 switch, without actually disconnecting these devices from their original switches.

The ES8508 supports IEEE 802.1Q VLAN, which is also known as Tag-Based VLAN. This Tag-Based VLAN allows a VLAN to be created across different switches. IEEE 802.1Q tag-based VLAN makes use of VLAN control information stored in a VLAN header attached to IEEE 802.3 packet frames. This tag contains a VLAN Identifier (VID) that indicates which VLAN a frame belongs to. Since each switch only has to check a frame's tag, without the need to dissect the contents of the frame, this saves a lot of computing resources within the ES8508.

The following figure displays an IEEE 802.1Q VLAN.

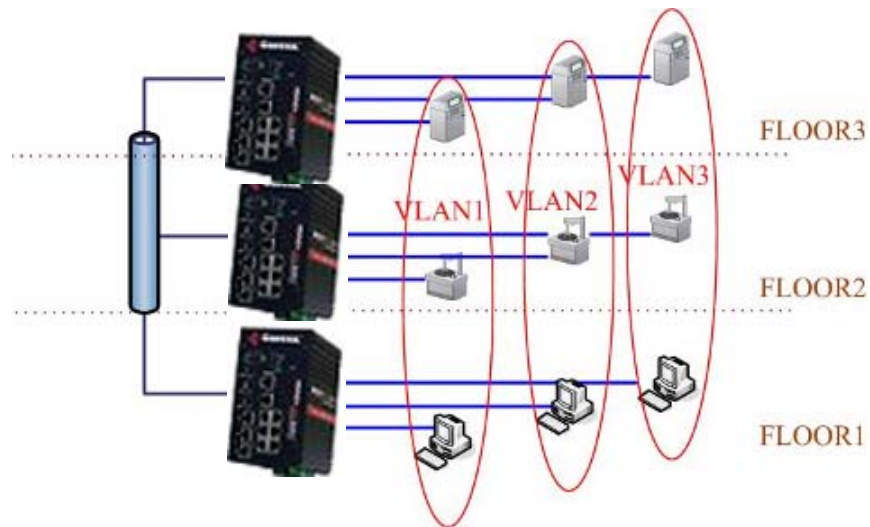

The ES8508 supports VLAN tunneling (QinQ), which expands the number of VLANs by adding a tag to the 802.1Q packets. The original VLAN is usually identified as Customer VLAN (C-VLAN) and the new VLAN is Service VLAN (S-VLAN). By adding the additional tag, QinQ increases the possible number of VLANs. After QinQ is enabled, the ES8508 can reach up to 256x256 VLANs. With different standard tags, it also improves network security.



VLAN Configuration pages allow you to add and remove a VLAN, configure port Ingress/Egress parameters, and view the VLAN table. The following pages are included in this group:

- [VLAN Port Configuration](#) on Page 90
- [VLAN Configuration](#) on Page 92
- [GVRP Configuration](#) on Page 95
- [VLAN Table](#) on Page 96

Optionally, you can use the CLI for configuration, see [VLAN \(CLI\)](#) on Page 164.

## VLAN Port Configuration

The *VLAN Port Configuration* page allows you to configure VLAN port parameters on a specific port. These parameters include the port VLAN ID (PVID), Tunnel Mode, Accept Frame Type and Ingress Filtering.

### VLAN Port Configuration

#### VLAN Port Configuration

Port	PVID	Tunnel Mode	Accept Frame Type	Ingress Filtering
1	1	None	Admit All	Disable
2	1	None	Admit All	Disable
3	1	None	Admit All	Disable
4	1	None	Admit All	Disable
5	1	None	Admit All	Disable
6	1	None	Admit All	Disable
7	1	None	Admit All	Disable
8	1	None	Admit All	Disable

Apply

### VLAN Port Configuration Page

PVID	Enter the port VLAN ID (PVID). The PVID allows the switches to identify which port belongs to which VLAN. To keep things simple, it is recommended that PVID is equivalent to VLAN IDs. The values of PVIDs are from 0 to 4,095 (0 and 4,095 are reserved), 1 is the default value; 2 to 4,094 are valid and available in this column. Enter the PVID you want to configure.
Tunnel Mode	<p><b>None</b> - IEEE 802.1Q tunnel mode is disabled.</p> <p><b>802.1Q Tunnel:</b> QinQ is applied to the ports which connect to the C-VLAN. The port receives a tagged frame from the C-VLAN. You need to add a new tag (Port VID) as an S-VLAN VID. When the packets are forwarded to the C-VLAN, the S-VLAN tag is removed. After <b>802.1Q Tunnel</b> mode is assigned to a port, the egress setting of the port should be <i>Untag</i>, it indicates that the egress packet is always untagged. This is configured in the Static VLAN Configuration table (<a href="#">Page 92</a>).</p> <p><b>802.1Q Tunnel Uplink:</b> QinQ is applied to the ports which connect to the S-VLAN. The port receives a tagged frame from the S-VLAN. When the packets are forwarded to the S-VLAN, the S-VLAN tag is kept. After <b>802.1Q Tunnel Uplink</b> mode is assigned to a port, the egress setting of the port should be <i>Tag</i>, it indicates that the egress packet is always tagged. This is configured in the Static VLAN Configuration table (<a href="#">Page 92</a>). For example, if the VID of S-VLAN/Tunnel Uplink is 10, the VID of C-VLAN/Tunnel is 5. The 802.1Q Tunnel port receives Tag 5 from C-VLAN and adds Tag 10 to the packet. When the packets are forwarded to S-VLAN, Tag 10 is kept.</p>
Accept Frame Type	<p>This defines the accepted frame type of the port. There are two modes you can select:</p> <ul style="list-style-type: none"> <li><b>Admit All</b> mode means that the port can accept both tagged and untagged packets. When you select <b>Admit All</b>, untagged frames or Priority-Tagged only frames received on this port are accepted and assigned to the PVID for this frame. This control does not affect VLAN independent BPDU frames, such as Super Ring, STP, GVRP and LACP. It does affect VLAN dependent BPDU frames, such as GMRP.</li> <li><b>Tag Only</b> mode means that the port can only accept tagged packets. When you select <b>Tag Only</b> the ES8508 discards untagged frames or Priority-Tagged only frames received on this port.</li> </ul>

VLAN Port Configuration Page (Continued)	
Ingress Filtering	<p>Ingress filtering instructs the VLAN engine to filter out undesired traffic on a port.</p> <ul style="list-style-type: none"> <li>• When you <b>Enable Ingress Filtering</b>, the port checks whether the incoming frames belong to the VLAN they claimed or not. The port then determines if the frames can be processed or not. For example, if a tagged frame from <i>TEST VLAN</i> is received, and Ingress Filtering is enabled, the ES8508 determines if the port is on the <i>TEST VLAN</i>'s Egress list. If it is, the frame can be processed. If it is not, the frame is dropped.</li> <li>• When you select <b>Disable</b>, the port accepts all incoming frames regardless of its VLAN classification. This control does not affect VLAN independent BPDU frames, such as Super Ring, STP, GVRP and LACP. It does affect VLAN dependent BPDU frames, such as GMRP.</li> </ul>
Apply	<p>Click <b>Apply</b> to apply the settings.</p> <p><b>Note:</b> You must <b>Save</b> the settings (<a href="#">Page 129</a>), if you want to maintain these settings if the ES8508 is powered off.</p>

## VLAN Configuration

---

Use this page to assign the Management VLAN, create the static VLAN, and assign the Egress rule for the member ports of the VLAN.

### VLAN Configuration

Management VLAN ID

Apply

### Static VLAN

VLAN ID	Name
<input type="text"/>	<input type="text"/>

Add

### Static VLAN Configuration

VLAN ID	Name	1	2	3	4	5	6	7	8
1	VLAN1	U	U	U	U	U	U	U	U

Apply

Remove

Reload

VLAN Configuration Page	
Management VLAN ID	<p>The management VLAN ID is the VLAN ID of the CPU interface so that only member ports of the management VLAN can ping and access the switch. The default management VLAN ID is 1.</p> <p>Click <b>Apply</b> after you enter the VLAN ID.</p>
Static VLAN	<p>You can assign a VLAN ID and VLAN Name for the new static VLAN.</p> <ul style="list-style-type: none"> <li><b>VLAN ID:</b> This is used by the switch to identify different VLANs. A valid VLAN ID is between 1 and 4,094, 1 is the default VLAN.</li> <li><b>VLAN Name:</b> This is a reference for the network administrator to identify different VLANs. The VLAN name may up to 12 characters in length. If you do not provide a VLAN name, the system automatically assigns a VLAN name</li> <li>. The rule is VLAN (VLAN ID).</li> </ul> <p>Click <b>Add</b> to create a new VLAN. The new VLAN displays in the Static VLAN Configuration table. After creating the VLAN, the status of the VLAN remains Unused, until you add ports to the VLAN.</p> <p><i><b>Note:</b> Before changing the management VLAN ID by web or Telnet, remember that the port attached by the administrator should be the member port of the management VLAN; otherwise the administrator cannot access the switch through the network. The ES8508 supports a maximum of 256 VLANs.</i></p>
Static VLAN Configuration	<ul style="list-style-type: none"> <li><b>VLAN ID:</b> The VLAN identifier for this VLAN.</li> <li><b>Name:</b> The name of the VLAN.</li> <li>1 - 8: The corresponding port number on the VLAN. <ul style="list-style-type: none"> <li>-- Not available</li> <li><b>U</b> Untag, indicates that egress/outgoing frames are not VLAN tagged.</li> <li><b>T</b> Tag, indicates that egress/outgoing frames are</li> <li>LAN tagged.</li> </ul> </li> <li>Click <b>Apply</b> to apply the settings.</li> </ul> <p><i><b>Note:</b> You must <b>Save</b> the settings (<a href="#">Page 129</a>), if you want to maintain these settings if the ES8508 is powered off.</i></p> <ul style="list-style-type: none"> <li>Click <b>Remove</b> to remove the selected static VLAN.</li> <li>Click <b>Reload</b> to reload static VLAN configuration.</li> </ul>

The following figure shows a static VLAN configuration table. The new VLAN 3 was created and the VLAN name is test. Egress rules of the ports are not configured.

**Static VLAN Configuration**

VLAN ID	Name	1	2	3	4	5	6	7	8
1	VLAN1	U	U	U	U	U	U	U	U
2	VLAN2	--	--	--	--	--	--	--	--
3	Test	--	--	--	--	--	--	--	--

This figure displays how to configure the Egress rule of the ports.

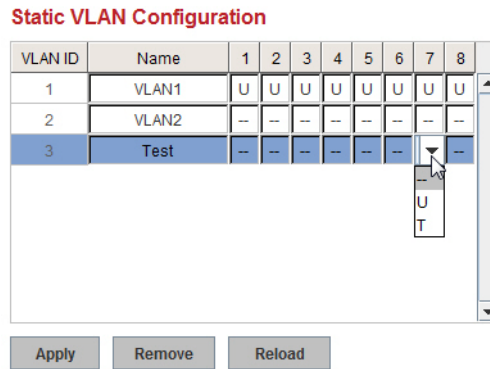

Use the following steps to configure Egress rules:

1. Select the VLAN ID. The entry of the selected VLAN turns to light blue.
2. Assign Egress rule of the ports to U or T.
3. Press **Apply** to apply the setting.

If you want to remove one VLAN, select the VLAN entry and then click the **Remove** button.

## GVRP Configuration

GARP VLAN Registration Protocol (GVRP) allows you to set-up VLANs automatically rather than manual configuration on every port on every switch in the network. GVRP conforms to the IEEE 802.1Q specification. This defines a method of tagging frames with VLAN configuration data that allows network devices to dynamically exchange VLAN configuration information with other devices.

GARP (Generic Attribute Registration Protocol), a protocol that defines procedures by which end stations and switches in a local area network (LAN) can register and de-register attributes, such as identifiers or addresses, with each other. Every end station and switch thus has a current record of all the other end stations and switches that can be reached. GVRP, like GARP, eliminates unnecessary network traffic by preventing attempts to transmit information to unregistered users. In addition, it is necessary to manually configure only one switch and all the other switches are configured accordingly.

### GVRP Configuration

**GVRP Protocol**

Port	State	Join Timer	Leave Timer	Leave All Timer
1	Disable	20	60	1000
2	Disable	20	60	1000
3	Disable	20	60	1000
4	Disable	20	60	1000
5	Disable	20	60	1000
6	Disable	20	60	1000
7	Disable	20	60	1000
8	Disable	20	60	1000

Note: Timer unit is centiseconds.

GVRP Configuration Page	
GVRP Protocol	Allows you to <b>Enable/Disable</b> GVRP globally.
State	After enabling GVRP globally, you can still <b>Enable/Disable</b> GVRP by port.
Join Timer	Controls the interval of sending the GVRP Join BPDU (Bridge Protocol Data Unit). An instance of this timer is required on a per-port, per-GARP participant basis.
Leave Timer	Controls the time to release the GVRP reservation after having received the GVRP Leave BPDU. An instance of the timer is required for each state machine that is in the LV state.
Leave All Timer	Controls the period to initiate the garbage collection of registered VLAN. The timer is required on a per-port, per-GARP participant basis.
Apply	Click <b>Apply</b> to apply the settings. <b>Note:</b> You must <b>Save</b> the settings ( <a href="#">Page 129</a> ), if you want to maintain these settings if the ES8508 is powered off.

## VLAN Table

This table displays the current settings of your VLAN table, including VLAN ID, Name, Status, and Egress rule of the ports.

### VLAN Table

#### VLAN Table

VLAN ID	Name	Status	1	2	3	4	5	6	7	8
1	VLAN1	Static	U	U	U	U	U	U	U	U
2	VLAN2	Unused	--	--	--	--	--	--	--	--
3	Test	Unused	--	--	--	--	--	--	--	--

Reload

VLAN Table Page	
VLAN ID	The ID of the VLAN.
Name	The name of the VLAN.
Status	<p><b>Static</b> means that this is a manually configured static VLAN.</p> <p><b>Unused</b> means this VLAN is created by web user interface/CLI and has no member ports and the VLAN is not workable yet.</p> <p><b>Dynamic</b> means this VLAN was learnt by GVRP.</p> <ul style="list-style-type: none"> <li>-- No VLAN setting.</li> <li><b>T</b> A Trunk Link is a LAN segment used for multiplexing VLANs between VLAN bridges. All the devices that connect to a Trunk Link must be IEEE 802.1Q VLAN-aware, which sends and receives frames with IEEE 802.1Q tags.</li> <li><b>U</b> An Access Link is a LAN segment used to multiplex one or more IEEE 802.1Q VLAN-unaware devices into a Port of a VLAN Bridge. Devices that are connected to an Access Link sends and receives frames without IEEE 802.1Q tagging, which is the identification of the VLAN it belongs to.</li> </ul>

After creating the VLAN, the status of this VLAN remains in **Unused** status until you add ports to the VLAN.



## Private VLAN

A private VLAN helps to resolve the primary VLAN ID shortage, client ports' isolation and network security issues. The private VLAN features provides primary and secondary VLANs within a single switch.

**Primary VLAN:** The uplink port is usually a member of the primary VLAN. A primary VLAN contains promiscuous ports that can communicate with Secondary VLANs.

**Secondary VLAN:** The client ports are usually defined within secondary VLAN. The secondary VLAN includes Isolated and Community VLANs. The client ports can be isolated VLANs or can be grouped in the same Community VLAN. The ports within the same community VLAN can communicate with each other, however, the isolated VLAN ports cannot.

This figure shows a typical private VLAN network. A SCADA/Public Server or NMS workstation is usually located in a primary VLAN. Client PCs and rings are usually located within the secondary VLAN.

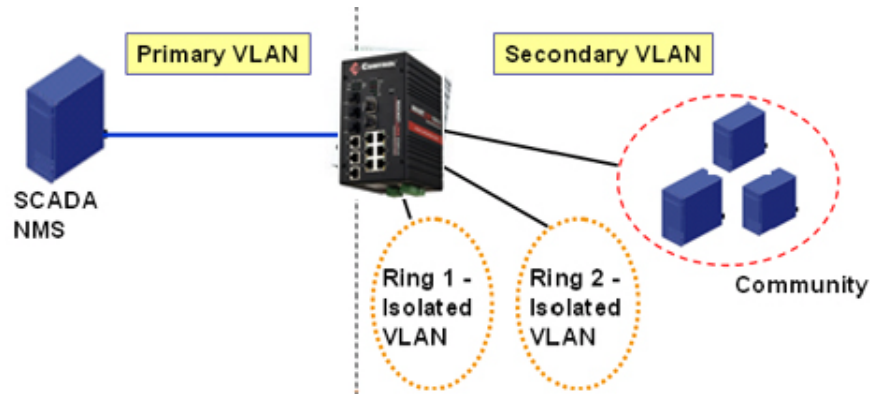

The following web pages are in this group:

- [PVLAN Configuration](#) on Page 97
- [PVLAN Port Configuration](#) on Page 98
- [PVLAN Information](#) on Page 99

Optionally, you can use the CLI for configuration, see [Private VLAN \(CLI\)](#) on Page 167.

## PVLAN Configuration

PVLAN Configuration allows you to assign a private VLAN type. Choose the private VLAN types for each VLAN you want configure.

**Note:** You must have previously configured a VLAN in the VLAN Configuration screen. Refer to [VLAN Configuration](#) on Page 92 for information.

Private VLAN Configuration Page	
VLAN ID	<ul style="list-style-type: none"> <li>• <i>Primary VLAN</i> - The uplink port is usually the primary VLAN. Ports within a primary VLAN can communicate with ports in a secondary VLAN</li> <li>• <i>Secondary VLAN</i> - The client ports are usually defined within secondary VLAN. The secondary VLAN includes Isolated VLAN and Community VLANs. The client ports can be isolated VLANs or can be grouped in the same Community VLAN. The ports within the same community VLAN can communicate with each other. However, the isolated VLAN ports cannot.</li> </ul>

### PVLAN Configuration

#### Private VLAN Configuration

VLAN ID	Private VLAN Type
2	Primary
3	Isolated

Apply

Private VLAN Configuration Page (Continued)	
Private VLAN Type	<ul style="list-style-type: none"> <li><b>None:</b> The VLAN is not included in private VLAN.</li> <li><b>Primary:</b> A primary VLAN contains promiscuous ports that can communicate with the secondary VLANs.</li> <li><b>Isolated:</b> The member ports of the VLAN are isolated.</li> <li><b>Community:</b> The member ports of the VLAN can communicate with each other.</li> </ul>
Apply	Click <b>Apply</b> to apply the settings. <i><b>Note:</b> You must <b>Save</b> the settings (<a href="#">Page 129</a>), if you want to maintain these settings if the ES8508 is powered off.</i>

### PVLAN Port Configuration

The *PVLAN Port Configuration* page allows you to configure the port configuration and private VLAN associations.

## PVLAN Port Configuration

### Port Configuration

Port	PVLAN Port Type	VLAN ID
1	Normal	None
2	Normal	None
3	Host	None
4	Host	None
5	Promiscuous	None
6	Promiscuous	None
7	Normal	None
8	Normal	None

**Apply**

### Private VLAN Association

Secondary VLAN	Primary VLAN
3	None

Private VLAN Port Configuration Page	
PVLAN Port Type	The following options are available: <b>Normal:</b> Normal ports remain in their original VLAN configuration. <b>Host:</b> Host ports can be mapped to the secondary VLAN. <b>Promiscuous:</b> Promiscuous ports can be associated to the primary VLAN.
VLAN ID	After assigning the port type, this displays the available VLAN ID for which the port can associate.
Private VLAN Association	
Secondary VLAN	After the isolated and community VLANs are configured in the <i>Private VLAN Configuration</i> page, the VLANs belonging to the second VLAN are displayed.

**Private VLAN Port Configuration Page (Continued)**

Primary VLAN	<p>After the Primary VLAN Type is assigned in <i>Private VLAN Configuration</i> page, the secondary VLAN can associate to the primary VLAN ID.</p> <p><b>Note:</b> <i>Before configuring PVLAN port type, the private VLAN Association should be done first.</i></p>
--------------	--

For example:

1. **VLAN Create:** VLANs 2-5 are created in the *VLAN Configuration* page.
2. **Private VLAN Type:** VLANs 2-5 has their own Private VLAN Type configured in the *Private VLAN Configuration* page.
  - VLAN 2 belongs to the Primary VLAN.
  - VLANs 3-5 belong to the secondary VLAN (Isolated or Community).
3. **Private VLAN Association:** Associate VLANs 3-5 to VLAN 2 in the Private VLAN Association first.
4. **Private VLAN Port Configuration**
  - VLAN 2 – Primary -> The member port of VLAN 2 is a promiscuous port.
  - VLAN 3 – Isolated -> The Host port can be mapped to VLAN 3.
  - VLAN 4 – Community -> The Host port can be mapped to VLAN 3.
  - VLAN 5 – Community -> The Host port can be mapped to VLAN 3.
5. **Result:**
  - VLAN 2 -> VLANs 3, 4, 5; member ports can communicate with the ports in secondary VLAN.
  - VLAN 3 -> VLAN 2, member ports are isolated, but it can communicate with the member ports of VLAN 2.
  - VLAN 4 -> VLAN 2, member ports within the community can communicate with each other and communicate with member ports of VLAN 2.
  - VLAN 5 -> VLAN 2, member ports within the community can communicate with each other and communicate with member ports of VLAN 2.

**PVLAN Information**

The *PVLAN Information* page allows you to see the private VLAN information. Click **Reload** to refresh the page contents.

**PVLAN Information**

**Private VLAN Information**

Primary VLAN	Secondary VLAN	Secondary VLAN Type	Port
2	-	-	-
-	3	Isolated	-

Reload

## Traffic Prioritization

Quality of Service (QoS) provides a traffic prioritization mechanism which allows you to deliver better service to certain flows. QoS can also help to alleviate congestion problems and ensure high-priority traffic is delivered first. This section allows you to configure Traffic Prioritization settings for each port with regard to setting priorities.

The ES8508 QoS supports four physical queues, weighted fair queuing (WRR) and Strict Priority scheme, that follows the IEEE 802.1p CoS tag and IPv4 TOS/DiffServ information to prioritize the traffic of your industrial network.

The following web pages are included in this group:

- [QoS Setting](#)
- [CoS-Queue Mapping](#) on Page 101
- [DSCP-Queue Mapping](#) on Page 102

Optionally, you can use the CLI for configuration, see [Traffic Prioritization \(CLI\)](#) on Page 171.

### QoS Setting

Use this subsection to set up QoS settings for the ES8508.

#### QoS Setting

##### Queue Scheduling

- Use an 8,4,2,1 weighted fair queuing scheme  
 Use a strict priority scheme

##### Port Setting

Port	CoS	Trust Mode
1	0	COS Only
2	0	COS Only
3	0	COS Only
4	0	COS Only
5	0	COS Only
6	0	COS Only
7	0	COS Only
8	0	COS Only

Apply

QoS Setting Page	
Use an 8,4,2,1 weighted fair queuing scheme	This is also known as <b>WRR</b> (Weight Round Robin). The ES8508 follows the 8:4:2:1 rate to process the packets in a queue from the highest priority to the lowest. For example, the system processes 8 packets with the highest priority in the queue, 4 with middle priority, 2 with low priority, and 1 with the lowest priority at the same time.
Use a strict priority scheme	Packets with higher priority in the queue are always processed first, except that there is no packet with higher priority.
CoS	The CoS column indicates that the default port priority value for untagged or priority-tagged frames. When the ES8508 receives the frames, the ES8508 attaches the value to the CoS field of the incoming VLAN-tagged packets. You can enable 0,1,2,3,4,5,6 or 7 to the port.

QoS Setting Page (Continued)	
Trust Mode	<p><b>Trust Mode</b> indicates the Queue Mapping types that you can select.</p> <ul style="list-style-type: none"> <li>• <b>COS Only</b> (default): The port priority follows the CoS-Queue Mapping you have assigned. The ES8508 provides the default CoS-Queue table for which you can refer to for the next command.</li> <li>• <b>DSCP Only</b>: Port priority only follows the DSCP-Queue Mapping you have assigned.</li> <li>• <b>COS first</b>: Port priority follows the CoS-Queue Mapping first, and then the DSCP-Queue Mapping rule.</li> <li>• <b>DSCP first</b>: Port priority follows the DSCP-Queue Mapping first, and then the CoS-Queue Mapping rule.</li> </ul>
Apply	<p>Click <b>Apply</b> to apply the settings.</p> <p><b>Note:</b> You must <b>Save</b> the settings (<a href="#">Page 129</a>), if you want to maintain these settings if the ES8508 is powered off.</p>

### CoS-Queue Mapping

Use this page to change the CoS values into the Physical Queue mapping table. Since the switch fabric of ES8508 supports four queues, Lowest, Low, Middle, and High users should therefore assign how to map the CoS value to the level of the physical queue.

You can assign the mapping table or follow the suggestion of the IEEE 802.1p standard. The ES8508 uses IEEE 802.1p suggestion as default values. CoS Values 1 and 2 are mapped to physical Queue 0, the lowest queue. CoS Values 0 and 3 are mapped to physical Queue 1, the low/normal physical queue. CoS Values 4 and 5 are mapped to physical Queue 2, the middle physical queue. CoS Values 6 and 7 are mapped to physical Queue 3, the high physical queue.

#### CoS-Queue Mapping

##### CoS-Queue Mapping

CoS	0	1	2	3	4	5	6	7
Queue	1	0	0	1	2	2	3	3

Note: Queue 3 is the highest priority queue in using Strict Priority scheme.

Apply

Class of service (CoS) is a 3 bit field within a layer two Ethernet frame header defined by IEEE 802.1p when using IEEE 802.1Q tagging. The field specifies a priority value of between 0 and 7 inclusive that can be used by Quality of Service (QoS) disciplines to differentiate traffic.

While CoS operates only on Ethernet at the data link layer, other QoS mechanisms (such as DiffServ) operate at the network layer and higher. Others operate on other physical layers. Although IEEE 802.1Q tagging must be enabled to communicate priority information from switch to switch, some switches use CoS to internally classify traffic for QoS purposes.

Differentiated Services (DiffServ) is a model where traffic is treated by intermediate systems with relative priorities based on the type of services (ToS) field. Defined in RFC2474 and RFC2475, the DiffServ standard supersedes the original specification for defining packet priority described in RFC791. DiffServ increases the number of definable priority levels by reallocating bits of an IP packet for priority marking. The DiffServ architecture defines the DiffServ field, which supersedes the ToS field in IPv4 to make per-hop behavior (PHB) decisions about packet classification and traffic conditioning functions, such as; metering, marking, shaping, and policing.

After configuration, press **Apply** to enable the settings.

**Note:** You must **Save** the settings ([Page 129](#)), if you want to maintain these settings if the ES8508 is powered off.

## DSCP-Queue Mapping

Use this page to change DSCP values to Physical Queue mapping table. Since the switch fabric of the ES8508 only supports four queues. Lowest, Low, Middle and High users should therefore assign how to map DSCP values to the level of the physical queue. You should therefore assign how to map DSCP value to the level of the queue. You can change the mapping table to follow the upper layer 3 switch or routers' DSCP setting.

### Traffic Prioritization

#### DSCP-Queue Mapping

DSCP	0	1	2	3	4	5	6	7
Queue	1	1	1	1	1	1	1	1
DSCP	8	9	10	11	12	13	14	15
Queue	0	0	0	0	0	0	0	0
DSCP	16	17	18	19	20	21	22	23
Queue	0	0	0	0	0	0	0	0
DSCP	24	25	26	27	28	29	30	31
Queue	1	1	1	1	1	1	1	1
DSCP	32	33	34	35	36	37	38	39
Queue	2	2	2	2	2	2	2	2
DSCP	40	41	42	43	44	45	46	47
Queue	2	2	2	2	2	2	2	2
DSCP	48	49	50	51	52	53	54	55
Queue	3	3	3	3	3	3	3	3
DSCP	56	57	58	59	60	61	62	63
Queue	3	3	3	3	3	3	3	3

Note: Queue 3 is the highest priority queue in using Strict Priority scheme.

Apply

After configuration, press **Apply** to enable the settings.

**Note:** You must Save the settings ([Page 129](#)), if you want to maintain these settings if the ES8508 is powered off.

## Multicast Filtering

---

For multicast filtering, the ES8508 uses IGMP (Internet Group Management Protocol) Snooping technology. IGMP is an internet protocol that provides a way for internet device to report its multicast group membership to adjacent routers. Multicasting allows one computer on the internet to send data to a multitude of other computers that have identified themselves as being interested in receiving the originating computer's data.

Multicasting is useful for such applications as updating the address books of mobile computer users in the field, sending out newsletters to a distribution list, and broadcasting streaming media to an audience that has tuned into the event by setting up multicast group membership.

In effect, IGMP Snooping manages multicast traffic by making use of switches, routers, and hosts that support IGMP. Enabling IGMP Snooping allows the ports to detect IGMP queries, report packets, and manage multicast traffic through the switch. IGMP has three fundamental types of messages, as shown in the following table.

Messages	
Query	A message sent from the querier (an IGMP router or a switch) that asks for a response from each host that belongs to the multicast group.
Report	A message sent by a host to the querier to indicate that the host wants to be or is a member of a given group indicated in the report message.
Leave Group	A message sent by a host to the querier to indicate that the host has quit as a member of a specific multicast group.

You can enable **IGMP Snooping** and **IGMP Query** functions. This section illustrates the information of the IGMP Snooping function, including different multicast groups' VID and member ports, and IP multicast addresses that range from 224.0.0.0 to 239.255.255.255.

The following web pages are included in this group:

- [IGMP Snooping](#) on Page 104
- [IGMP Query](#) on Page 105
- [Unknown Multicast](#) on Page 105
- [GMRP Configuration](#) on Page 106

Optionally, you can use the CLI for configuration, see [Multicast Filtering \(CLI\)](#) on Page 174.



## IGMP Snooping

Use this page to enable the IGMP Snooping feature, assign IGMP Snooping for specific VLANs, and view the IGMP Snooping table from a dynamic learnt.

**IGMP Snooping**

**IGMP Snooping** Disable ▾

	VID	IGMP Snooping
<input type="checkbox"/>	1	Disabled
<input type="checkbox"/>	2	Disabled
<input type="checkbox"/>	3	Disabled

Select All

**IGMP Snooping Table**

IP Address	VID	1	2	3	4	5	6	7	8

IGMP Snooping Page	
IGMP Snooping	<p>You can select <b>Enable</b> or <b>Disable</b>. After enabling IGMP Snooping, you can then enable IGMP Snooping for specific VLAN.</p> <p>You can <b>Enable</b> IGMP Snooping for some VLANs so that some of the VLANs support IGMP Snooping and others do not.</p> <p>To assign IGMP Snooping to VLAN, click the check box of the VLAN ID or click the <b>Select All</b> check box for all VLANs and then click <b>Enable</b>. You can also <b>Disable</b> IGMP Snooping for certain VLANs using the same method.</p>
IGMP Snooping Table	<p>This table displays the multicast group IP address, VLAN ID it belongs to, and member ports of the multicast group. The ES8508 supports 256 multicast groups. Click <b>Reload</b> to refresh the table.</p>

**Note:** You must **Save** the settings ([Page 129](#)), if you want to maintain these settings if the ES8508 is powered off.



## IGMP Query

Use this page to configure the IGMP Query feature. Since the ES8508 can only be configured by member ports of the management VLAN, the IGMP Query can only be enabled on the management VLAN. If you want to run IGMP Snooping feature in several VLANs, first check to see whether each VLAN has its own IGMP Querier.

The IGMP querier periodically sends query packets to all end-stations on the LANs or VLANs that are connected to it. For networks with more than one IGMP querier, a switch with the lowest IP address becomes the IGMP querier.

### IGMP Query

#### IGMP Query on the Management VLAN

Version	Disable ▾
Query Interval(s)	<input type="text"/>
Query Maximum Response Time(s)	<input type="text"/>
<input type="button" value="Apply"/>	

IGMP Query Page	
Version	<p>Select <b>Version 1</b>, <b>Version 2</b> or <b>Disable</b>.</p> <ul style="list-style-type: none"> <li><b>Version 1</b> means IGMP V1 General Query</li> <li><b>Version 2</b> means IGMP V2 General Query. The query is forwarded to all multicast groups in the VLAN.</li> <li><b>Disable</b> allows you to disable IGMP Query.</li> </ul>
Query Interval(s)	The period of query (seconds) sent by querier. Enter a number between 1 and 65,535.
Query Maximum Response Time	The span querier detect (seconds) to confirm there are no more directly connected group members on a LAN. Enter a number between 1 and 25.
Apply	<p>Click <b>Apply</b> to apply the settings.</p> <p><b>Note:</b> You must <b>Save</b> the settings (<a href="#">Page 129</a>), if you want to maintain these settings if the ES8508 is powered off.</p>

## Unknown Multicast

This page allows you to decide how to forward the unknown multicast traffic. After enabling IGMP Snooping, the known multicast can be filtered by IGMP Snooping mechanism and forwarded to the member ports of known multicast groups. The other multicast streams that are not learned are called unknown multicasts, the ES8508 decides how to forward them based on the setting on this page.

### Unknown Multicast

#### Unknown Multicast

- Send to Query Ports
- Send to All Ports
- Discard

UnKnown Multicast Page	
Send to Query Ports	The unknown multicast is sent to the Query ports. The Query port means the port received the IGMP Query packets. It is usually the uplink port of the switch.
Send to All Ports	The unknown multicast is flooded on all ports even if they are not member ports of the groups.
Discard	The unknown multicast is discarded. Non-member ports do not receive the unknown multicast streams.
Apply	<p>Click <b>Apply</b> to apply the settings.</p> <p><b>Note:</b> You must <b>Save</b> the settings (<a href="#">Page 129</a>), if you want to maintain these settings if the ES8508 is powered off.</p>

## GMRP Configuration

GARP Multicast Registration Protocol (GMRP) is a Generic Registration Protocol (GARP) application that provides a multicast traffic management facility at Layer 2 similar to what IGMP provides at Layer 3. GMRP and GARP are industry-standard protocols first introduced as part of IEEE 802.1D.

GMRP Configuration	
GMRP Protocol	Enable/Disable GMRP protocol.
State	The state of the GMRP operation on this port. The value enabled indicates that the GMRP is enabled on this port as long as the GMRP protocol is also enabled for this device. When disabled, but the GMRP protocol is still enable for the device, GMRP is disabled on this port.
Apply	Click <b>Apply</b> to apply the settings. <i><b>Note:</b> You must <b>Save</b> the settings (<a href="#">Page 129</a>), if you want to maintain these settings if the ES8508 is powered off.</i>

### GMRP Configuration

GMRP Protocol Disable ▼

Port	State
1	Disable
2	Disable
3	Disable
4	Disable
5	Disable
6	Disable
7	Disable
8	Disable

Apply

## SNMP

Simple Network Management Protocol (SNMP) is a protocol to exchange management information between network devices. SNMP is a member of the TCP/IP protocol suite. The ES8508 supports SNMP v1 and v2c and v3.

An SNMP managed network consists of two main components: agents and a manager. An agent is a management software module that resides in a managed switch. An agent translates the local management information from the managed device into a SNMP compatible format. The manager is the console through the network.

The following web pages are included in this group:

- [SNMP Configuration](#)
- [SNMP V3 Profile](#) on Page 108
- [SNMP Traps](#) on Page 109

Optionally, you can use the CLI for configuration, see [SNMP \(CLI\)](#) on Page 177.

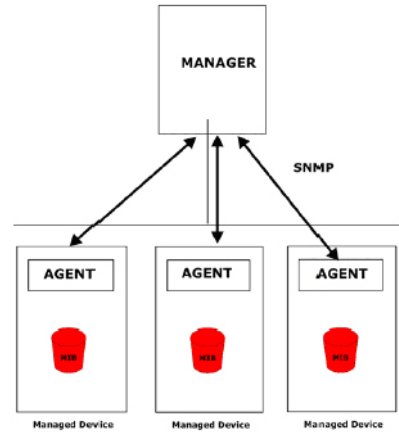

### SNMP Configuration

Use this page to configure the SNMP v1/v2c Community. The community string can be viewed as the password because SNMP v1/v2c does not request you to enter a password before you try to access the SNMP agent.

The community includes two privileges:

- **Read Only** privilege, you only have the ability to read the values of MIB tables. The default community string is **public**.
- **Read and Write** privilege, you have the ability to read and set the values of MIB tables. The default community string is **private**.

The ES8508 allows you to assign four community strings. Type the community string, select the privilege, and then click **Apply**.

**Note:** When you first install the device in your network, we recommend that you change the community string. Most SNMP management applications use public and private as the default community name, this could be a network security leak.

#### SNMP

##### SNMP V1/V2c Community

Community String	Privilege
public	Read Only
private	Read and Write
	Read Only
	Read Only

Apply

## SNMP V3 Profile

SNMP v3 can provide more security functions when you perform remote management through SNMP protocol. It delivers SNMP information to the administrator with user authentication; all of data between the ES8508 and the administrator are encrypted to ensure secure communication.

### SNMP V3 Profile

#### SNMP V3

User Name	<input type="text"/>
Security Level	None ▾
Auth. Level	MD5 ▾
Auth. Password	<input type="text"/>
DES Password	<input type="text"/>

Add

#### SNMP V3 Users

User Name	Security Level	Auth. Level	Auth. Password	DES Password

Remove

Reload

SNMP V3 Profile Page	
User Name	SNMP v3 user name.
Security Level	Select the following levels of security: <b>None</b> , <b>Authentication</b> , and <b>Authentication and Privacy</b> .
Auth Level	<p>Select either <b>MD5</b> (Message-Digest algorithm 5) or <b>SHA</b> (Secure Hash Algorithm).</p> <ul style="list-style-type: none"> <li><b>MD5</b> is a widely used cryptographic hash function with a 128-bit hash value.</li> <li><b>SHA</b> functions refer to five Federal Information Processing Standard-approved algorithms for computing a condensed digital representation.</li> </ul> <p>The ES8508 provides two user authentication protocols in MD5 and SHA. You need to configure SNMP v3 parameters for your SNMP tool with the same authentication method.</p>
Auth Password	Enter the SNMP v3 user authentication password.
DES Password	Enter the password for SNMP v3 user DES Encryption.
Add	Click to add an SNMP v3 user.
SNMP V3 Users	<p>This table provides SNMP v3 user information.</p> <p>Click <b>Remove</b> to remove a selected SNMP v3 user.</p> <p>Click <b>Reload</b> to reload SNMP v3 user information.</p>

**Note:** You must **Save** the settings ([Page 129](#)), if you want to maintain these settings if the ES8508 is powered off.

## SNMP Traps

SNMP Trap is the notification feature defined by SNMP protocol. All the SNMP management applications can understand such trap information. So you do not need to install new applications to read the notification information.

SNMP Trap Page	
SNMP Trap	Click <b>Enable</b> or <b>Disable</b> SNMP trap functionality.
Apply	Click <b>Apply</b> to apply the settings. <b>Note:</b> You must <b>Save</b> the settings ( <a href="#">Page 129</a> ), if you want to maintain these settings if the ES8508 is powered off.
SNMP Trap Server	
Server IP	The SNMP trap server IP address.
Community	The SNMP trap server community string.
Version	The SNMP trap version, V1 or V2c.
Add	Click the <b>Add</b> button to add a SNMP server.
Trap Server Profile	
Server IP	The SNMP trap server IP address
Community	The SNMP trap server community string.
Version	The SNMP trap version, V1 or V2c.
Remove	Click the <b>Remove</b> button to remove selected SNMP server.
Reload	Click the <b>Reload</b> button to reload SNMP server information.

You can see the change of the SNMP pre-defined standard traps and Control pre-defined traps. The pre-defined traps can be found in the [Control private MIB](#).

**Note:** You must **Save** the settings ([Page 129](#)), if you want to maintain these settings if the ES8508 is powered off.

### SNMP Trap

SNMP Trap Disable ▾

Apply

#### SNMP Trap Server

Server IP	<input type="text"/>
Community	<input type="text"/>
Version	<input checked="" type="radio"/> V1 <input type="radio"/> V2c

Add

#### Trap Server Profile

Server IP	Community	Version

Remove

Reload



## IP Security

Use the *Security IP* page to set up specific IP addresses to grant authorization for management access to this ES8508 through a web browser or Telnet.

IP Security Page	
IP Security	Select <b>Enable</b> and <b>Apply</b> to enable the IP security function.
Add Security IP	You can assign specific IP addresses and then click <b>Add</b> . Only these IP addresses can access and manage ES8508 through a web browser or Telnet. The maximum security IP is 10.
Security IP List	This table shows you added the security IP addresses.
Remove	Click <b>Remove</b> to delete a highlighted entry.
Reload	To reload the table.

### IP Security

IP Security  ▼

#### Add Security IP

Security IP

#### Security IP List

Index	Security IP

## 802.1x Configuration

IEEE 802.1x is the protocol that performs authentication to obtain access to IEEE 802 LANs. It is port-based network access control. With the function, the ES8508 could control which connection is available or not.

### 802.1x Port-Based Network Access Control Configuration

**System Auth Control**

**Authentication Method**

**RADIUS Server**

RADIUS Server IP	192.168.10.100
Shared Key	radius-key
Server Port	1812
Accounting Port	1813

**Local RADIUS User**

Username	Password	VID
<input type="text"/>	<input type="text"/>	<input type="text"/>

**Secondary RADIUS Server**

RADIUS Server IP	<input type="text"/>
Shared Key	<input type="text"/>
Server Port	<input type="text"/>
Accounting Port	<input type="text"/>

**Local RADIUS User List**

Username	Password	VID

IEEE 802.1x Page	
System Auth Control	Enable or Disable the IEEE 802.1x authentication.
Authentication Method	RADIUS is an authentication server that provides a key for authentication. When you use this method, you must connect the switch to the server. If you select Local for the authentication method, the switch uses the local user database that can be created in this page for authentication.
RADIUS Server	
RADIUS Server IP	The IP address of the RADIUS server.
Shared Key	The password used to communicate between the ES8508 and the RADIUS Server.
Server Port	The UDP port of the RADIUS server.
Accounting Port	The port for packets that contains the account login or logout information.
Secondary RADIUS Server	
RADIUS Server IP	You can set a Secondary RADIUS Server, if the primary RADIUS server goes down.
Shared Key	The password used to communicate between the ES8508 and the secondary RADIUS Server.
Server Port	The UDP port of the secondary RADIUS server.
Accounting Port	The port for packets that contains the account login or logout information for the secondary server.



**IEEE 802.1x Page (Continued)**

Local RADIUS User	<p>You can add an Account/Password for local authentication.</p> <ul style="list-style-type: none"> <li>• User name: The user name of the local RADIUS user.</li> <li>• Password: The password of the local RADIUS user.</li> <li>• VID: The VLAN ID (VID) of the local RADIUS user.</li> </ul> <p>Click the <b>Add</b> button to add a local RADIUS user.</p>
Local RADIUS User List	<p>Shows the account information, select <b>Remove</b> to remove a selected account.</p> <ul style="list-style-type: none"> <li>• User name: The user name of the local RADIUS user.</li> <li>• Password: The password of the local RADIUS user.</li> <li>• VID: The VLAN ID (VID) of the local RADIUS user.</li> </ul>

**802.1x Port Configuration**

After configuring the **RADIUS Server** or **Local RADIUS User List**, you also need to configure the authentication mode, authentication behavior, applied VLAN for each port, and permitted communications.

**802.1x Port-Based Network Access Control Port Configuration**

**802.1x Port Configuration**

Port	Port Control	Reauthentication	Max Request	Guest VLAN	Host Mode	Admin Control Direction
1	Force Authorized	Disable	2	0	Single	Both
2	Force Authorized	Disable	2	0	Single	Both
3	Force Authorized	Disable	2	0	Single	Both
4	Force Authorized	Disable	2	0	Single	Both
5	Force Authorized	Disable	2	0	Single	Both
6	Force Authorized	Disable	2	0	Single	Both

**802.1x Timeout Configuration**

Port	Re-Auth Period(s)	Quiet Period(s)	Tx Period(s)	Supplicant Timeout(s)	Server Timeout(s)
1	3600	60	30	30	30
2	3600	60	30	30	30
3	3600	60	30	30	30
4	3600	60	30	30	30
5	3600	60	30	30	30
6	3600	60	30	30	30

<b>802.1x Port Configuration Page</b>	
Port control	<b>Force Authorized</b> means that this port is authorized; the data is free to move in/out. <b>Force unauthorized</b> is just the opposite, the port is blocked. To control this port with a RADIUS server, select <b>Auto</b> for port control.
Reauthentication	If this field is enabled, the ES8508 requests the client to re-authenticate. The default time interval is 3600 seconds.
Max Request	This is the maximum times that the ES8508 allows a client request.
Guest VLAN	The permitted range for this field is 0 to 4094. If this field is set to 0, that means the port is blocked after an authentication failure. Otherwise, the port is set to Guest VLAN.
Host Mode	If there is more than one device connected to this port, set the Host Mode to <b>Single</b> , which means only the first PC to authenticate successfully can access this port. If this port is set to <b>Multi</b> , all of the devices can access this port once any one of them passes the authentication.
Admin Control Direction	Use this to determine which devices can only send data or both send and receive data.
Apply	Click <b>Apply</b> to apply the settings.
Initialize Selected	Click to set the authorization state of the selected port to initialize status.
Reauthenticate Selected	Click to send an EAP Request to the requestor to request reauthentication.
Default Selected	Click to reset the configurable IEEE 802.1x parameters of selected port to the default values.
<b>802.1x Timeout Configuration</b>	
Re-Auth Period(s)	Controls the re-authentication time interval (seconds), you can enter a range of 1 - 65535.
Quiet Period(s)	When authentication fails, the ES8508 waits for a period and then tries to communicate with the RADIUS server again.
Tx Period(s)	The time interval of the authentication request.
Supplicant Timeout(s)	The timeout for the client authentication.
Sever Timeout(s)	The timeout for the server response for authentication.
Apply	Click <b>Apply</b> to apply the settings. <b>Note:</b> You must <b>Save</b> the settings ( <a href="#">Page 129</a> ), if you want to maintain these settings if the ES8508 is powered off.

## 802.1x Port Status

Use the *802.1x Port Status* page to observe the port status for **Port Control Status**, **Authorize Status**, **Authorized Supplicant**, and **Oper Control Direction** for each port.

### 802.1x Port-Based Network Access Control Port Status

Port	Port Control	Authorize Status	Authorized Supplicant	Oper Control Direction
1	Force Authorized	AUTHORIZED	NONE	Both
2	Force Authorized	AUTHORIZED	NONE	Both
3	Force Authorized	AUTHORIZED	NONE	Both
4	Force Authorized	AUTHORIZED	NONE	Both
5	Force Authorized	AUTHORIZED	NONE	Both
6	Force Authorized	AUTHORIZED	NONE	Both
7	Force Authorized	AUTHORIZED	NONE	Both
8	Force Authorized	AUTHORIZED	NONE	Both

Reload

## Warning

The ES8508 provides several types of warning features for you to remotely monitor the status of the attached devices or changes in your network. The features include System Log and SMTP Email Alert.

The following web pages are included in this group:

- [Fault Relay](#)
- [Event Selection](#) on Page 118
- [SysLog Configuration](#) on Page 119
- [SMTP Configuration](#) on Page 120

Optionally, you can use the CLI for configuration, see [Warnings \(CLI\)](#) on Page 180.

## Fault Relay

The ES8508 provides one alarm relay output (DO) that can support multiple fault conditions. The relay contacts are energized (open) for normal operation and close under fault conditions. The fault conditions include power failure, Ethernet port link faults, Ring topology changes, Ping failures, DI state changes or ping remote IP address failure.

### Fault Relay

Relay 1	Status is Off		
<input type="checkbox"/> Power	Power ID	Power DC1 ▼	
<input type="checkbox"/> Port Link	Port	<input type="checkbox"/> 1 <input type="checkbox"/> 2 <input type="checkbox"/> 3 <input type="checkbox"/> 4 <input type="checkbox"/> 5 <input type="checkbox"/> 6 <input type="checkbox"/> 7 <input type="checkbox"/> 8	
<input type="checkbox"/> Ring	Ring Failure		
<input type="checkbox"/> Ping	IP Address	<input type="text"/>	
<input type="checkbox"/> Ping Reset	IP Address	Reset Time(Sec)	Hold Time(Sec)
<input type="checkbox"/> Dry Output	On Period(Sec)	Off Period(Sec)	
<input type="checkbox"/> DI	DI Number	DI 1 ▼	DI State High ▼
<input type="button" value="Apply"/> <input type="button" value="Reload"/>			

The **Relay 1** field shows the current state of the relay. If the relay is triggered, the event type is marked with an asterisk (\*). The above image shows that a power event occurred.

The following table describes Fault Relay conditions:

Fault Relay	
Power	Detects power input status on DC1, DC2, or both power sources.
Port Link	Monitors port link down events for the selected ports.
Ring	Monitors ring topology changes.
Ping	If the target IP address does not reply to the ping request, the fault relay is enabled.
Ping Reset	<p>Pings target device and triggers the relay to emulate to emulate a power reset on the remote device if the remote system crashes.</p> <ul style="list-style-type: none"> <li>• <b>IP Address:</b> Remote device IP address whose power wiring is connected with relay output.</li> <li>• <b>Reset Time (Sec):</b> Duration that the relay contact is opened to emulate the power switch is off. After the reset time, the relay closes to emulate that the power switch is on.</li> <li>• <b>Hold Time (Sec):</b> Boot time that the remote device requires. After the relay contact closes the ES8508 starts pinging after the hold time.</li> </ul>

<b>Fault Relay</b>	
Dry Output	<p>The relay continuously opens and closes the contacts. The available range is 0-65535 seconds.</p> <p><b>Note:</b> <i>Do not use this function with any other event.</i></p> <ul style="list-style-type: none"> <li>• <b>On Period:</b> Duration of the relay output short (closed).</li> <li>• <b>Off Period:</b> Duration of the relay output open.</li> </ul>
DI	Relay triggered when DI changes state to high or low.
Apply	<p>Click <b>Apply</b> to apply the settings.</p> <p><b>Note:</b> <i>You must <b>Save</b> the settings (<a href="#">Page 129</a>), if you want to maintain these settings if the ES8508 is powered off.</i></p>

## Event Selection

Event Types can be divided into two basic groups: System Events and Port Events. System Events are related to the overall function of the switch, whereas Port Events are related to the activity of specific ports.

### Warning - Event Selection

#### System Event Selection

- Device Cold Start
- Device Warm Start
- Authentication Failure
- Time Synchronize Failure
- Power 1 Failure
- Power 2 Failure
- Fault Relay
- DI1 Change
- Ring Event
- Loop Protection

#### Port Event Selection

Port	Link State
1	Disable
2	Disable
3	Disable
4	Disable
5	Disable
6	Disable
7	Disable
8	Disable

System Event	Warning is sent when....
Device Cold Start	Power is cut off and then reconnected.
Device Warm Start	Reboot the device by CLI or web user interface.
Power 1 Failure	Select this if you want the ES8508 to send notification of a PW1 failure.
Power 2 Failure	Select this if you want the ES8508 to send notification of a PW2 failure.
Authentication failure	An incorrect password or SNMP Community String is entered.
Time Synchronize Failure	Accessing the NTP Server is failing.
Fault Relay	Fault Relay has occurred.
DI1 Change	The Digital Input#1 status has changed.
DI2 Change	The Digital Input#2 status has changed.
Ring Event	A ring event has occurred.
Port Event	Warning is sent when.....
Link-Up	The port is connected to another device.
Link-Down	The port is disconnected. For example, the cable is pulled out or the opposing devices is down.
Both	The link status changed.
Apply	Click <b>Apply</b> to apply the settings. <b>Note:</b> You must <b>Save</b> the settings ( <a href="#">Page 129</a> ), if you want to maintain these settings if the ES8508 is powered off.

## SysLog Configuration

The System Log provides the system administrator ES8508 events history. There are two System Log modes provided by the ES8508, **Local** mode and **Remote** mode.

### Warning - SysLog configuration

Syslog Mode	Disable
Remote IP Address	

Note: When enabled Local and Both mode, you can monitor the system logs in the [Monitor and Diag]/[Event Log] page.

Apply

Warning - SysLog Configuration Page	
Syslog Mode	<p>There are two system logs available:</p> <ul style="list-style-type: none"> <li>• <b>Local Mode:</b> The ES8508 prints the events that have been selected in the Event Selection page to the System Log table of the ES8508. You can monitor the system logs in the <i>Monitor and Diag / Event Log</i> page.</li> <li>• <b>Remote Mode:</b> Assign the IP address of the System Log server. The ES8508 sends the events that occurred in the selected in <i>Event Selection</i> page to System Log server that you assign.</li> <li>• <b>Both:</b> This enables both <b>Local</b> and <b>Remote</b> modes.</li> </ul>
Remote IP Address	The IP address of the System log server.
Apply	<p>Click <b>Apply</b> to apply the settings.</p> <p><b>Note:</b> You must <b>Save</b> the settings (<a href="#">Page 129</a>), if you want to maintain these settings if the ES8508 is powered off.</p>

When enabling **Local** or **Both** modes, you can monitor the system logs in the *Monitor and Diag / Event Log* page.

## SMTP Configuration

The ES8508 supports an email alert feature. The ES8508 sends the events that have occurred to a remote email server. The email warning conforms to the SMTP standard.

The *E-mail Alert* page allows you to assign the SMTP Server IP, Sender E-mail, and Receiver E-mail. If the SMTP server requests authentication, you can set up the user name and password.

### Warning - SMTP Configuration

**E-mail Alert** Disable ▾

**SMTP Configuration**

SMTP Server IP	192.168.0.1
Mail Account	admin@192.168.0.1
<input type="checkbox"/> Authentication	
User Name	
Password	
Confirm Password	
Rcpt E-mail Address 1	
Rcpt E-mail Address 2	
Rcpt E-mail Address 3	
Rcpt E-mail Address 4	

SMTP Configuration Page	
SMTP Server IP Address	Enter the IP address of the email server.
Mail Account	The mail account for the SMTP server.
Authentication	Click the check box to enable password.
User Name	Enter an email account name (maximum 40 characters).
Password	Enter the password of the email account.
Confirm Password	Re-type the password of the email account.
<i>You can set up to 4 email addresses to receive email alarm from the ES8508.</i>	
Rcpt E-mail Address 1	The first email address to receive an email alert from the ES8508 (maximum 40 characters).
Rcpt E-mail Address 2	The second email address to receive an email alert from the ES8508 (maximum 40 characters).
Rcpt E-mail Address 3	The third email address to receive an email alert from the ES8508 (maximum 40 characters).
Rcpt E-mail Address 4	The fourth email address to receive an email alert from the ES8508 (maximum 40 characters).
Apply	Click <b>Apply</b> to apply the settings. <b>Note:</b> You must <b>Save</b> the settings ( <a href="#">Page 129</a> ), if you want to maintain these settings if the ES8508 is powered off.



## Monitor and Diag

The ES8508 provides several web user interface pages for you to monitor the status of the switch or diagnostics when encountering problems related to the ES8508. The features include MAC Address Table, Port Statistics, Port Mirror, Event Log, and Ping.

The following web pages are included in this group:

- [MAC Address Table](#)
- [Port Statistics](#) on Page 123
- [Port Mirroring](#) on Page 124
- [Event Log](#) on Page 125
- [Topology Discovery \(LLDP\)](#) on Page 126
- [Ping Utility](#) on Page 127

Optionally, you can use the CLI for configuration, see [Monitor and Diag \(CLI\)](#) on Page 183.

### MAC Address Table

The ES8508 provides 8K entries in the *MAC Address Table*. You can change the Aging time, add Static Unicast MAC Address, monitor the MAC address or sort them by different packet types and ports.

#### MAC Address Table

Aging Time (secs)

#### Static Unicast MAC Address

MAC Address	VID	Port
<input type="text"/>	<input type="text"/>	Port 1 ▾

MAC Address Table

MAC Address	Address Type	VID	1	2	3	4	5	6	7	8
0000.bc22.2784	Dynamic Unicast	1	<input type="checkbox"/>	<input type="checkbox"/>	<input type="checkbox"/>	<input type="checkbox"/>	<input checked="" type="checkbox"/>	<input type="checkbox"/>	<input type="checkbox"/>	<input type="checkbox"/>
0000.bc2a.4fca	Dynamic Unicast	1	<input type="checkbox"/>	<input type="checkbox"/>	<input type="checkbox"/>	<input type="checkbox"/>	<input checked="" type="checkbox"/>	<input type="checkbox"/>	<input type="checkbox"/>	<input type="checkbox"/>
0001.0324.929b	Dynamic Unicast	1	<input type="checkbox"/>	<input type="checkbox"/>	<input type="checkbox"/>	<input type="checkbox"/>	<input checked="" type="checkbox"/>	<input type="checkbox"/>	<input type="checkbox"/>	<input type="checkbox"/>
000c.7654.474a	Dynamic Unicast	1	<input type="checkbox"/>	<input type="checkbox"/>	<input type="checkbox"/>	<input type="checkbox"/>	<input checked="" type="checkbox"/>	<input type="checkbox"/>	<input type="checkbox"/>	<input type="checkbox"/>
000c.76e9.89c2	Dynamic Unicast	1	<input type="checkbox"/>	<input type="checkbox"/>	<input type="checkbox"/>	<input type="checkbox"/>	<input checked="" type="checkbox"/>	<input type="checkbox"/>	<input type="checkbox"/>	<input type="checkbox"/>
000f.7300.d1ef	Dynamic Unicast	1	<input type="checkbox"/>	<input type="checkbox"/>	<input type="checkbox"/>	<input type="checkbox"/>	<input checked="" type="checkbox"/>	<input type="checkbox"/>	<input type="checkbox"/>	<input type="checkbox"/>
000f.7303.636c	Dynamic Unicast	1	<input type="checkbox"/>	<input type="checkbox"/>	<input type="checkbox"/>	<input type="checkbox"/>	<input checked="" type="checkbox"/>	<input type="checkbox"/>	<input type="checkbox"/>	<input type="checkbox"/>
0010.5aa7.4c68	Dynamic Unicast	1	<input type="checkbox"/>	<input type="checkbox"/>	<input type="checkbox"/>	<input type="checkbox"/>	<input checked="" type="checkbox"/>	<input type="checkbox"/>	<input type="checkbox"/>	<input type="checkbox"/>

MAC Address Table Page	
Aging Time (Sec)	<p>Each switch fabric has a size limit to write the learnt MAC address. To save more entries for a new MAC address, the switch fabric ages out a non-used MAC address entry per the Aging Time timeout.</p> <p>This value determines the interval that an automatically learnt MAC address entry remains valid in the forwarding database, since its last access as a source address, before being purged. The value should be increments of 15 in seconds.</p> <p>The minimum age time is 15 seconds. The maximum age time is 3825 seconds or almost 64 minutes. The default <b>Aging Time</b> is 300 seconds.</p> <p>If the value is set to 0, the aging function is disabled and all learned addresses remain in the database forever.</p>
Static Unicast MAC Address	<p>Some applications may require that you type in the static Unicast MAC address to its MAC address table. Type the MAC address (format: xxxx.xxxx.xxxx), select its VID, and Port ID, and then click <b>Add</b> to add it to MAC Address Table.</p>
MAC Address Table	<p>This displays all the MAC addresses learnt by the switch fabric.</p> <p>The packet types include Management Unicast, Static Unicast, Dynamic Unicast, Static Multicast, and Dynamic Multicast.</p> <p>The table allows you to sort the address by the packet types and port.</p>
Address Types	<ul style="list-style-type: none"> <li>• <b>Management Unicast</b> means the MAC address of the switch. It belongs only to the CPU port.</li> <li>• <b>Static Unicast</b> MAC addresses can be added and deleted.</li> <li>• <b>Dynamic Unicast</b> MAC is a MAC address learnt by the switch Fabric.</li> <li>• <b>Static Multicast</b> can be added by the CLI and can be deleted using the web user interface and CLI.</li> <li>• <b>Dynamic Multicast</b> appears after you enabled IGMP and the switch learnt IGMP report.</li> <li>• <b>Management Multicast</b> - multicast address that is configured for management purposes, such as GVRP and so on. Management entries are read-only.</li> </ul> <p>Dynamic and static entries can be removed.</p>
Remove	<p>Click to remove the static Unicast/Multicast MAC address.</p>
Reload	<p>Click to reload to refresh the table. The new learnt Unicast/Multicast MAC address are updated in the <i>MAC Address Table</i>.</p>
Apply	<p>Click <b>Apply</b> to apply the settings.</p> <p><b>Note:</b> You must <b>Save</b> the settings (<a href="#">Page 129</a>), if you want to maintain these settings if the ES8508 is powered off.</p>

## Port Statistics

Use this page to view operation statistics for each port. The statistics that can be viewed include **Link Type**, **Link State**, **Rx Good**, **Rx Bad**, **Rx Abort**, **Tx Good**, **Tx Bad** and **Collisions**.

**Note:** *If you see an increase of Bad, Abort or Collision counts, that may mean the network cable is not properly connected or the network performance of the port is poor. Check your network cable, the network interface card of the connected device, the network application, or reallocate the network traffic.*

The following information provides a view of the current port statistic information.

### Port Statistics

Port	Type	Link	State	Rx Good	Rx Bad	Rx Abort	Tx Good	Tx Bad	Collision
1	100BASE	Down	Enable	0	0	0	0	0	0
2	100BASE	Up	Enable	1459222	0	52030	5	0	0
3	100BASE	Down	Enable	0	0	0	0	0	0
4	100BASE	Down	Enable	0	0	0	0	0	0
5	100BASE	Up	Enable	1460751	0	514	8882	0	0
6	100BASE	Down	Enable	0	0	0	0	0	0
7	100BASE	Down	Enable	0	0	0	0	0	0
8	100BASE	Down	Enable	0	0	0	0	0	0

Port Statistics Page	
Type	Indicates the port type.
Link	Indicates the link status; <b>Up</b> or <b>Down</b> .
State	Indicates the link state; <b>Enable</b> or <b>Disable</b> .
RX Good	The count of good frames received, which is the total number of received unicast, broadcast, multicast, and pause frames.
RX Bad	The count of bad frames received, which is the total number of undersize, fragment, oversize, jabber, receive errors ( <b>RxErr</b> ), and frame check sequence errors ( <b>FCSErr</b> ) frames.
RX Abort	The count of abort frames received, which is the total number of discarded and filtered frames.
TX Good	The count of good frames transmitted, which is the total number of transmitted unicast, broadcast, multicast and pause frames.
TX Bad	The count of <b>FCSErr</b> frames transmitted.
Collision	The count of collision frames, including single, multiple, excessive, and late collisions frames.
Clear Selected	Click to clear selected port counts.
Clear All	Click to clear all counts.
Reload	Click to reload all counts.

## Port Mirroring

Port mirroring (also called *port spanning*) is a tool that allows you to mirror the traffic from one or more ports onto another port, without disrupting the flow of traffic on the original port. Any traffic that goes into or out of the **Source Ports** is duplicated at the **Destination Ports**. This traffic can then be analyzed at the Destination Port using a monitoring device or application. The network administrator typically utilizes this tool for diagnostics, debugging, or fending off attacks.

### Port Mirroring

Port Mirror Mode  ▼

#### Port Selection

Port	Source Port		Destination Port	
	Rx	Tx	Rx	Tx
1	<input type="checkbox"/>	<input type="checkbox"/>	<input type="radio"/>	<input type="radio"/>
2	<input type="checkbox"/>	<input type="checkbox"/>	<input type="radio"/>	<input type="radio"/>
3	<input type="checkbox"/>	<input type="checkbox"/>	<input type="radio"/>	<input type="radio"/>
4	<input type="checkbox"/>	<input type="checkbox"/>	<input type="radio"/>	<input type="radio"/>
5	<input type="checkbox"/>	<input type="checkbox"/>	<input type="radio"/>	<input type="radio"/>
6	<input type="checkbox"/>	<input type="checkbox"/>	<input type="radio"/>	<input type="radio"/>
7	<input type="checkbox"/>	<input type="checkbox"/>	<input type="radio"/>	<input type="radio"/>
8	<input type="checkbox"/>	<input type="checkbox"/>	<input type="radio"/>	<input type="radio"/>

Port Mirroring Mode Page	
Port Mirror Mode	Select <b>Enable</b> or <b>Disable</b> to enable/disable port mirroring.
Source Port	This is also known as <i>Monitor Port</i> . These are the ports that you want to monitor. The traffic of all source/monitor ports is copied to destination/analysis ports. You can choose a single port, or any combination of ports, but you can only monitor them in Rx or TX only.  Click the check box of the <b>Port ID</b> , <b>RX</b> , <b>Tx</b> or both to select the source ports.
Destination Port	This is also known as <i>Analysis Port</i> . You can analyze the traffic of all the monitored ports at this port without affecting the flow of traffic on the port or ports being monitored. Only one RX/TX of the destination port can be selected. The network administrator typically connects a LAN analyzer or Netxray device to this port.
Apply	Click <b>Apply</b> to apply the settings.  <b>Note:</b> You must <b>Save</b> the settings ( <a href="#">Page 129</a> ), if you want to maintain these settings if the ES8508 is powered off.

## Event Log

The System Log feature was introduced in [SysLog Configuration](#) on Page 119. When **System Log Local** mode is selected, the ES8508 records events that occurred in the local log table. This page shows the log table. The entry includes the index, occurred data and time, and content of the events.

Click **Clear** to clear the entries. Click **Reload** to refresh the table.

### System Event Logs

Index	Date	Time	Event Log
1	Sep 4	16:32:01	Event Link 2 Up.
2	Sep 4	16:31:59	Event Link 4 Down.
3	Sep 4	16:31:54	Event Link 4 Up.
4	Sep 4	16:31:51	Event Link 2 Down.
5	Sep 4	16:31:42	Event Link 2 Up.
6	Sep 4	16:31:40	Event Link 4 Down.
7	Sep 4	16:31:37	Event Link 4 Up.
8	Sep 4	16:31:35	Event Link 2 Down.

## Topology Discovery (LLDP)

The ES8508 supports topology discovery or LLDP (IEEE 802.1AB Link Layer Discovery Protocol) functionality that can help to discovery multi-vendor’s network devices on the same segment by a network monitoring system (NMS) that supports LLDP functionality.

**Topology Discovery**

**LLDP** Disable ▾

**LLDP Configuration**

LLDP timer	
LLDP hold time	

**LLDP Port State**

Local Port	Neighbor ID	Neighbor IP	Neighbor VID	

Apply

With LLDP functionality, NMS can easily maintain the topology map, display port ID, port description, system description, and VLAN ID. Once a link failure occurs, the topology changes the events that can be updated to the NMS as well. The **LLDP Port State** can display the neighbor ID and IP learnt from the connected devices.

<b>Topology Discovery Page</b>	
LLDP	Select <b>Enable/Disable</b> to enable/disable LLDP function.
<b>LLDP Configuration</b>	
LLDP timer	This is the interval time of each LLDP in seconds; valid values are from 5 to 254. The default is 30 seconds.
LLDP hold time	The Time to Live (TTL) timer. The LLDP state expires when the LLDP is not received by the hold time. The default is 120 seconds. and the range is from 10 to 255.
<b>LLDP Port State</b>	
Local Port	The current port number that linked with network device.
Neighbor ID	The MAC address of the peer device on the same network segment.
Neighbor IP	The IP address of the peer device on the same network segment.
Neighbor VID	The VLAN ID of the peer device on the same network segment.
Apply	Click <b>Apply</b> to apply the settings. <b>Note:</b> You must <b>Save</b> the settings ( <a href="#">Page 129</a> ), if you want to maintain these settings if the ES8508 is powered off.

## Ping Utility

---

This page provides a **Ping Utility** to ping a remote device and check whether the device is alive or not. Type the **Target IP** address of the target device and click **Start** to start the ping.

### Ping Utility

#### Ping

Target IP Address	192.168.11.201
<input type="button" value="Start"/>	

#### Result

```
PING 192.168.11.201 (192.168.11.201): 56 data bytes
64 bytes from 192.168.11.201: seq=0 ttl=128 time=0.8 ms
64 bytes from 192.168.11.201: seq=1 ttl=128 time=0.8 ms
64 bytes from 192.168.11.201: seq=2 ttl=128 time=0.9 ms
64 bytes from 192.168.11.201: seq=3 ttl=128 time=0.8 ms
64 bytes from 192.168.11.201: seq=4 ttl=128 time=0.8 ms

--- 192.168.11.201 ping statistics ---
5 packets transmitted, 5 packets received, 0% packet loss
round-trip min/avg/max = 0.8/0.8/0.9 ms
```

After few seconds, you can see the result in the **Result** field.

## Device Front Panel

The Device Front Panel allows you to see the LED status of the ES8508.

### Device Front Panel      Device Front Panel

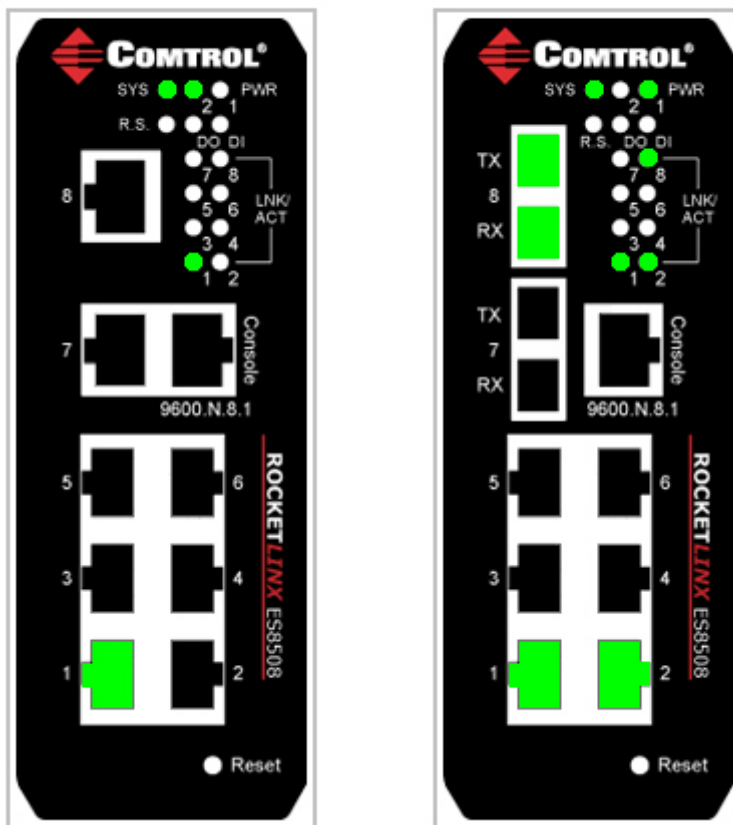

LED Name	LED On/Link Up	LED Off/Link Down
Sys (System)	Green: System operational	Black: System not ready
PWR 1 PWR 2	Green: Power	White: Not powered
DO (Digital Output)	Green: DO activated	White: DO not activated
DI (Digital Input)	Green: DI activated	White: DI not activated
R.S. (Ring Redundancy Manager)	Green: Ring state is normal	Black: Ring feature not enabled
LNK/ACT	Green: Link active	Black: Not connected
Ports 1- 8	Green: Link active	Black: Not connected

**Note:** There is not a CLI command for this feature. If you can view the physical LEDs, you can use the [LED Descriptions](#) on Page 14, which provide detailed LED information.



---

## Save to Flash

---

The **Save Configuration** page saves any changes to the configuration to the flash.

If the switch loses power before clicking **Save Configuration** causes loss of the new settings. Applying changes on web user interface pages do not save the changes to the flash.

After selecting **Save Configuration**, click **Save to Flash** to save your new configuration.

### Save to Flash

Note: This command will permanently save the current configuration to flash.

Save to Flash

Optionally, you can use the CLI, see [Saving to Flash \(CLI\)](#) on Page 186.

---

## Logout

---

Click the **Logout** option in the web user interface to manually logout the web connection.

If you have saved your changes, click **Yes** to logout, **No** to remain the web user interface.

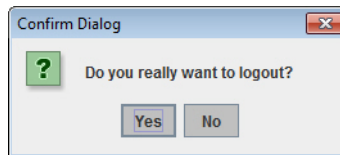

If you did not save your changes, you can save your changes when you logout.

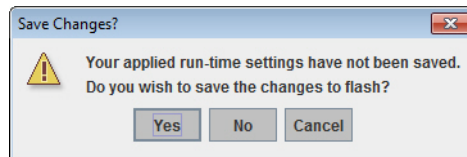



# Configuration Using the Command Line Interface (CLI)

## Overview

---

The ES8508 provides in-band and out-band configuration methods:

- Out-band management means that you configure the ES8508 using the RS-232 console cable and the Command Line Interface (CLI) to access the ES8508 without attaching an admin PC to the network. You can use out-band management if you lose the network connection to the ES8508.
- In-band management means that you connect remotely using the ES8508 IP address through the network. You can remotely connect with the ES8508 embedded Java applet web user interface or a Telnet console and the CLI.

If you are planning on using in-band management, you need to program the ES8508 IP address to meet your network requirements. The easiest way to configure the IP address is using a Windows system and PortVision DX, which is discussed in [Configuring the Network Settings](#) on Page 21.

If you want to use the web user interface for configuration, see [Configuration Using the Web User Interface](#) on Page 35.

Use the following procedures to access the ES8508 using the CLI:

- [Using the Serial Console](#)
- [Using a Telnet/SSH Console](#)

This section contains information about the following groups of commands:

- [Basic Settings \(CLI\)](#) on Page 146
- [Port Configuration \(CLI\)](#) on Page 152
- [Network Redundancy \(CLI\)](#) on Page 155
- [VLAN \(CLI\)](#) on Page 164
- [Private VLAN \(CLI\)](#) on Page 167
- [Traffic Prioritization \(CLI\)](#) on Page 171
- [Multicast Filtering \(CLI\)](#) on Page 174
- [SNMP \(CLI\)](#) on Page 177
- [Security \(CLI\)](#) on Page 178
- [Warnings \(CLI\)](#) on Page 180
- [Monitor and Diag \(CLI\)](#) on Page 183
- [Saving to Flash \(CLI\)](#) on Page 186
- [Logging Out \(CLI\)](#) on Page 186
- [Service \(CLI\)](#) on Page 186

## Using the Serial Console

Control provides one RS-232 RJ45 console cable with the ES8508.

**Note:** A system COM port is required to use a serial console connection. If you do not have an available COM port, use the [Using a Telnet/SSH Console](#) procedure on [Page 133](#).

1. Attach the RS-232 DB9 connector to your PC COM port and connect the other end to the **Console** port of the ES8508. If you misplace the cable, you can use this console cable pin assignment or purchase a null-modem cable.

RJ45 Pin	DB9F Pin
1	7
2	9
3	4
4	5
5	1
6	3
7	2
8	8

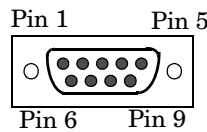

2. Start a terminal program such as HyperTerminal or the Control Test Terminal program. You can download Test Terminal from the [FTP site](#).

- [Test Terminal](#) - WCom2 (Windows XP through Windows 8)
  - Unzip Test Terminal and place it in a location that you can execute an application.
  - Execute **Wcom2.exe**.
  - Click the **File** menu, the **Open Port** option and then click the appropriate COM port number.

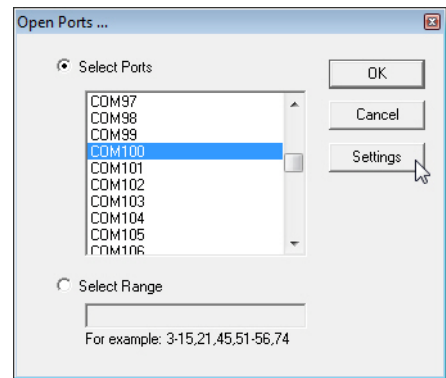

- Click **Settings**, use the values in the following table, and then click **Ok**.

Serial Settings	Value
Baud Rate	9600
Data bits	8
Parity	None
Stop Bit	1
Flow Control	None

- Click **Ok**.
- Press the cursor in the Terminal window and press the **Enter** key.

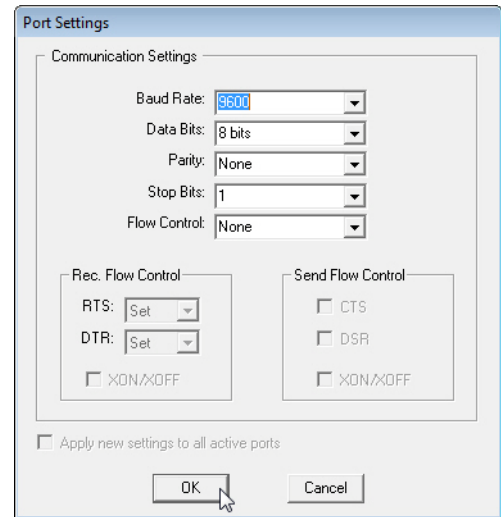

- HyperTerminal (Windows XP, *unless installed manually*)
  - *Windows XP*: Go to **Start -> Program -> Accessories -> Communications -> HyperTerminal**
  - Enter a name for the new console connection and click **OK**.
  - Enter the IP address in the **Host Address** text box.
  - Select **TCP/IP (Winsock)** in the **Connect using** drop-list and click **Ok**.
  - Set the serial settings using the [Serial Settings](#) table (above).
  - Press the **Enter** key in the Terminal window.
  - After it is connected, you can see the *Switch login* request, go to [Step 3](#)

3. Log in to the switch. The default user name is **admin**, password, **admin**.

```
Switch login: admin
Password:

Switch (version 1.3-20121211-16:25:00).

Switch>
```

4. If necessary, configure the IP address for your network. The following example shows how to program an IP address of 192.168.11.252 with a Class B subnet mask (255.255.0.0).

```
Switch> enable
Switch# configure terminal
Switch(config)# int vlan1
Switch(config-if)# ip address 192.168.11.252/16
```

### Using a Telnet/SSH Console

The ES8508 supports a Telnet console or SSH console with the Command Line Interface (CLI), which is the same as what you see using the RS-232 console port. The SSH connection can secure all the configuration commands you send to the ES8508.

SSH is a client/server architecture while the ES8508 is the SSH server. When you want to make SSH connection with the ES8508, you may need to download an SSH client tool.

The following subsections provide procedures:

- [Using PortVision DX \(Telnet or SSH\)](#) on Page 134
- [Telnet - Windows XP](#) on Page 135 (Windows XP)
- [SSH Client](#) on Page 136

Using PortVision DX (Telnet or SSH)

You can use PortVision DX to access the CLI using the following procedure.

1. If you have not done so, install PortVision DX ([Installing PortVision DX](#) on Page 19).
2. Start PortVision DX.
3. Right-click the ES8508 in the *Device List* pane (lower) and click **Telnet/SSH**.

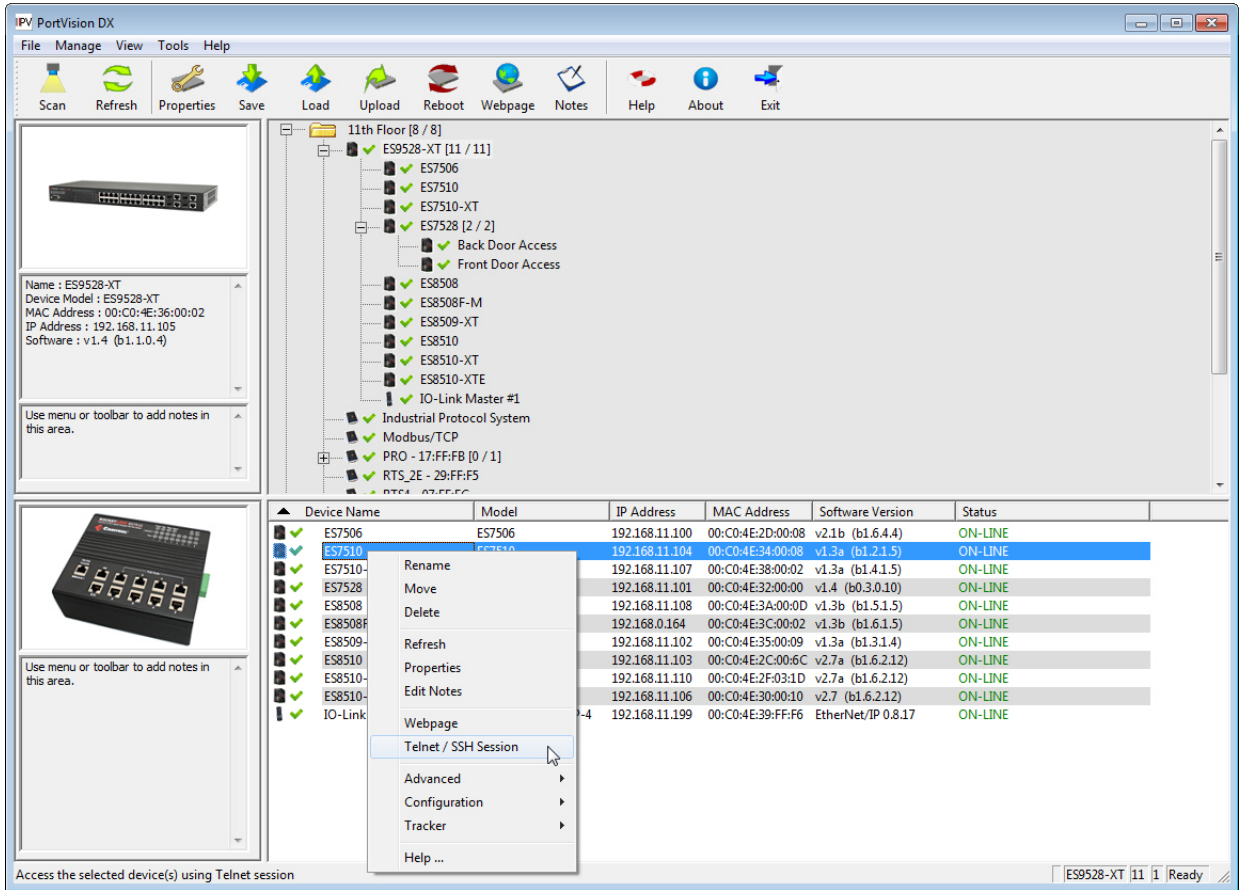

4. Select either Telnet or SSH and leave the default port number.

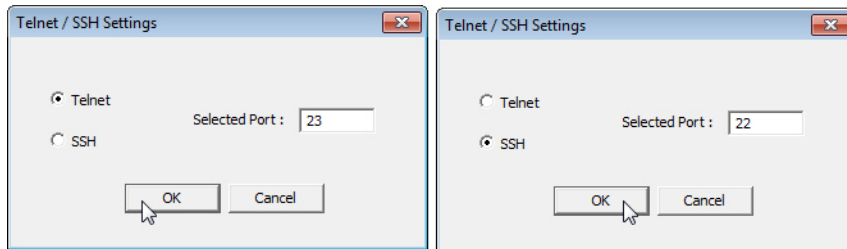

If you selected SSH, click **Yes**.

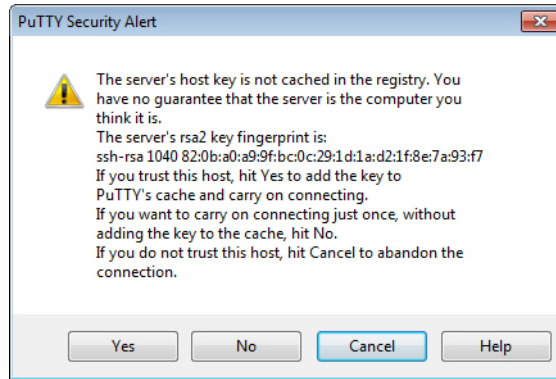

- Enter the user name (default = **admin**).
- Enter the password (default = **admin**).

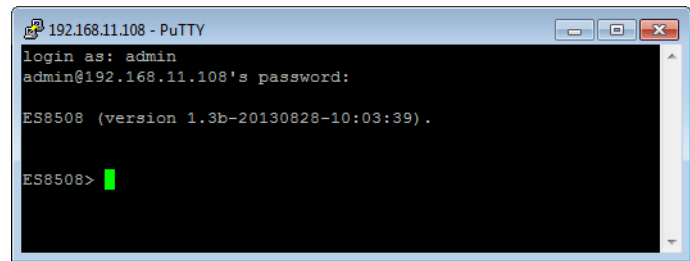

If you selected Telnet:

- Enter the user name (default = **admin**).
- Enter the password (default = **admin**).

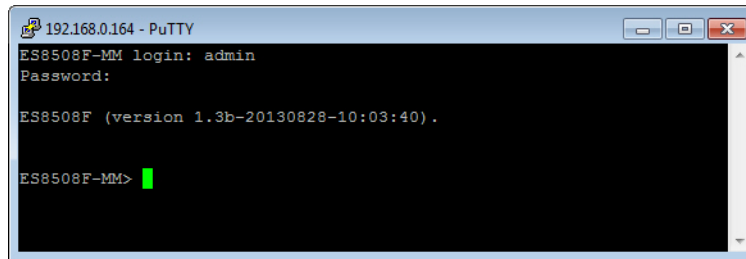

### Telnet - Windows XP

The following shows how to open a Telnet connection to the ES8508 using Windows XP.

1. Go to **Start -> Run -> cmd** and then press **Enter**.
2. Type **Telnet 192.168.250.250** (or the IP address of the ES8508) and then press **Enter**.
3. Enter the *Login Name* and *Password*. The default login name and password are **admin**.

All the commands you see in SSH are the same as the CLI commands you see through the RS-232 console.

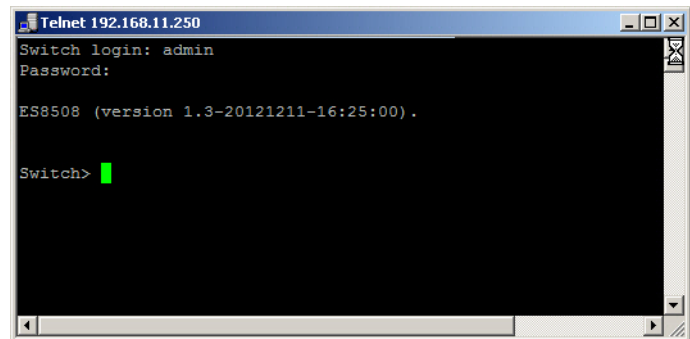

SSH Client

There are many free, sharewares, trials or charged SSH clients you can find on the internet. For example, PuTTY is a free and popular Telnet/SSH client.

**Note:** You can install and use PortVision DX, which also installs PuTTY.

The following procedures shows how to login with SSH and PuTTY.

1. Download PuTTY (the Telnet and SSH client itself) from:  
<http://www.chiark.greenend.org.uk/~sgtatham/putty/download.html>
2. Click **Run** to start PuTTY.
3. In the **Session** configuration, enter the **Host Name** (IP address of the ES8508), **Port number** (default = 22), click **SSH** for the protocol, and then click **Open** to start the SSH session console.

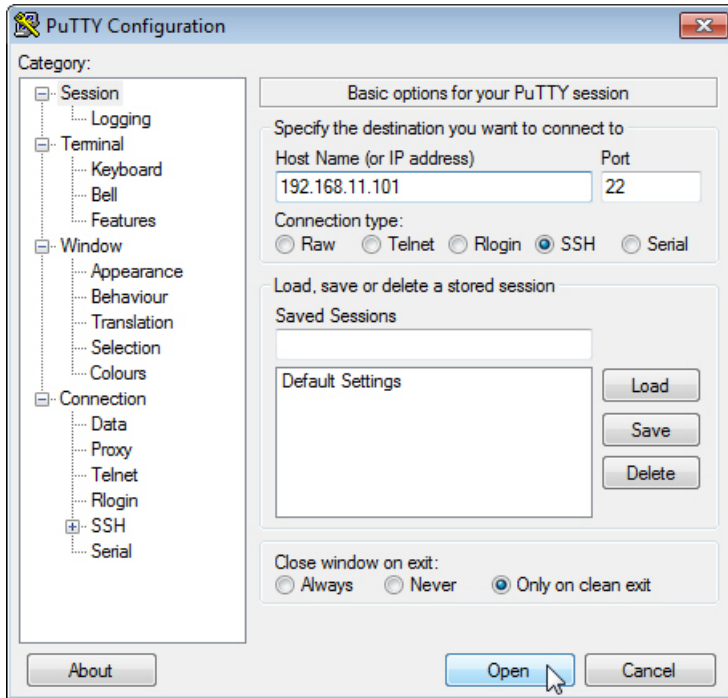
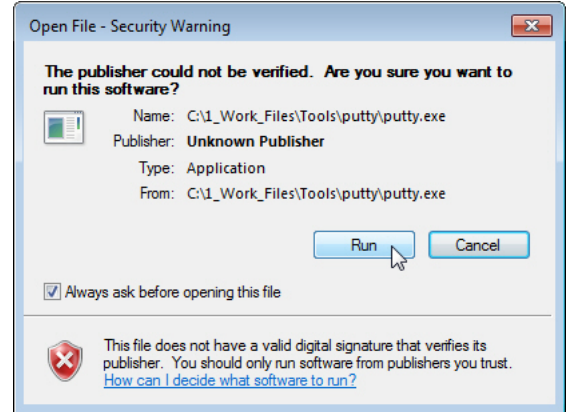

4. After click **Open**, you the cipher information displays in the popup screen. Click **Yes** to accept the Security Alert.

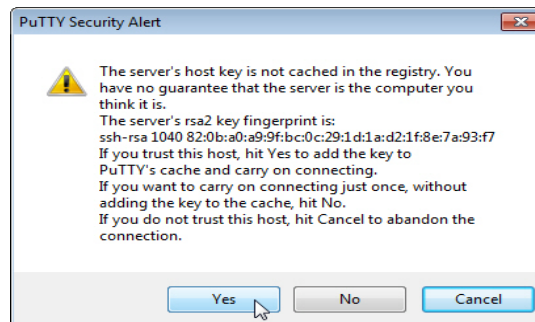

After few seconds, the SSH connection to the ES8508 opens.



5. Enter the *Login Name* and *Password*. The default login name and password are **admin**.

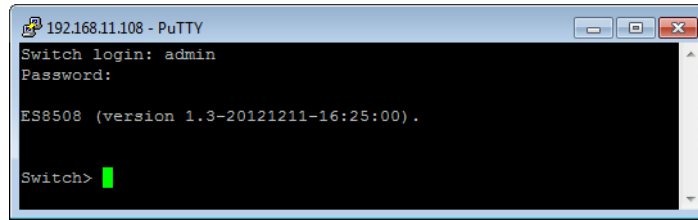

All the commands you see in SSH are the same as the CLI commands you see through the RS-232 console.

## Command Line Interface Introduction

The Command Line Interface (CLI) is the user interface to the ES8508 embedded software. You can view the system information, show the status, configure the switch, and receive a response back from the system by keying in a command.

There are several different command modes. Each command mode has its own access ability, available command lines and uses different command lines to enter and exit. These modes are:

- [User EXEC Mode](#) on Page 137, which includes commands to ping or telnet to a remote device, and show some basic information and to access *Privileged EXEC* mode
- [Privileged EXEC Mode](#) on Page 140, which provides a view current configuration, reset default, reload switch, show system information, save configuration, and access *Global Configuration* mode
- [Global Configuration Mode](#) on Page 141, which you can use configure all ES8508 features and access to one of the *Interface Configuration* modes
- [\(Port\) Interface Configuration](#) on Page 142, which can be used to configure port settings
- [\(VLAN\) Interface Configuration](#) on Page 143, which can be used to configure the settings for a specific VLAN

Refer to [Configuration Using the Command Line Interface \(CLI\)](#) on Page 131 to access the CLI.

### User EXEC Mode

When you login to the ES8508 with the CLI, you are in *User EXEC* mode.

In *User EXEC* mode, you can ping, telnet to a remote device, and show some basic information.

Type the command and press **Enter**:

- **enable** to access *Privileged EXEC* mode ([Privileged EXEC Mode](#) on Page 140).
- **exit** to logout.
- **?** to see the command list.
- **list** to review the *User EXEC* mode commands and corresponding options.

Switch>	
enable	Turn on privileged mode command
exit	Exit current mode and down to previous mode
list	Print command list
ping	Send echo messages
quit	Exit current mode and down to previous mode
show	Show running system information
telnet	Open a telnet connection
traceroute	Trace route to destination

For the complete list of commands with options, refer to [User EXEC Mode](#) on Page 187.

## Accessing the Options for a Command

---

---

The following example illustrates how to view the description and options for a command. This example illustrates the **show** command and the firmware version displayed may not reflect your firmware version.

**Note:** The **?** does not appear on the screen.

1. If you type **show?** (without a space between **show** and the **?**; do not press the **Enter** key) the ES8508 provides a basic description of that command.

```
Switch login: admin
Password:

Switch (version 2.7 -20130314 - 15:23:41)
switch> show
  show Show running system information
```

2. If you type **show ?** (with a space between **show** and the **?**; do not press the **Enter** key) the ES8508 provides information about the options for that command.

```
Switch> show
  arp          ARP table
  gvrp         GARP VLAN Registration Protocol
  ip           IP information
  version      Displays ISS version
Switch> show
```

3. Type **show ip ?** (with a space between **show** and the **?**, do not press the **Enter** key) to review the options for **ip**.

```
Switch> show ip
  forwarding  IP forwarding status
  route       IP routing table
```

4. Type **show ip route** and press the **Enter** key to view the IP routing tables for the ES8508.

```
Switch> show ip route
Codes: K - kernel route, C - connected, S - static, R - RIP, O - OSPF,
       B - BGP, > - selected route, * - FIB route

S>* 0.0.0.0/0 [1/0] via 192.168.250.1, inactive
C>* 127.0.0.0/8 is directly connected, lo
C>* 192.0.0.0/8 is directly connected, vlan1
```

5. If you type **list** and press **Enter**, the ES8508 provides you information about all of the commands and options for a mode. The following example shows the available commands and their options for *User EXEC* mode.

```
ES8508> list
enable
exit
list
ping WORD
ping ipv6 WORD
quit
show arp
show gvrp statistics [IFNAME]
show ip forwarding
show ip route
show ip route A.B.C.D
show ip route A.B.C.D/M
show ip route supernets-only
show version
telnet WORD
telnet WORD PORT
traceroute WORD
traceroute ipv6 WORD
```

## Privileged EXEC Mode

---

If you type **enable** in *User EXEC* mode, you can access *Privileged EXEC* mode. In this mode, the ES8508 allows you to view current configuration, reset default, reload switch, show system information, save configuration, and enter *Global Configuration* mode.

Type the following commands and press the **Enter** key:

- **configure terminal** to access *Global Configuration* mode ([Global Configuration Mode](#) on Page 141).
- **exit** to close the CLI.
- **?** to see the command list.
- **list** to review the *Privileged EXEC* mode commands and corresponding options.

For the complete list of commands and options, refer to [Privileged EXEC Mode](#) on Page 188.

```
Switch>enable
Switch#
archive      manage archive files
clear        Reset functions
clock        Configure time-of-day clock
configure    Configuration from vty interface
copy         Copy from one file to another
debug        Debugging functions
disable      Turn off privileged mode command
dot1x        IEEE 802.1x standard access security control
end          End current mode and change to enable mode
exit         Exit current mode and down to previous mode
hardware     Hardware function
list         Print command list
no           Negate a command or set its defaults
pager        Terminal pager
ping         Send echo messages
quit        Exit current mode and down to previous mode
reboot       Reboot system
reload       copy a default-config file to replace the current one
show         Show running system information
telnet       Open a telnet connection
terminal     Set terminal line parameters
traceroute   Trace route to destination
write        Write running configuration to memory, network, or terminal
```

## Global Configuration Mode

If you type **configure terminal** in *Privileged EXEC* mode, you can then access *Global Configuration* mode. In *Global Configuration* mode, you can configure all ES8508 features. Type the following commands and press the **Enter** key:

- **interface IFNAME/VLAN**, to access the corresponding *Interface Configuration* mode.
- **exit** to return to *Privileged EXEC* mode.
- **?** to see the command list.
- **list** to review the *Global Configuration* mode commands and corresponding options.

The following is a list of available command lists of *Global Configuration* mode. For the complete list of commands and options, refer to [Global Configuration Mode](#) on Page 193..

```
Switch# configure terminal
Switch(config)#
  administrator      Administrator account setting
  arp                 Set a static ARP entry
  clock               Configure time-of-day clock
  default             Set a command to its defaults
  dot1x               IEEE 802.1x standard access security control
  end                 End current mode and change to enable mode
  ethertype           Ethertype
  exit                Exit current mode and down to previous mode
  gmrp                GMRP protocol
  gvrp                GARP VLAN Registration Protocol
  hostname            Set system's network name
  interface           Select an interface to configure
  ip                  IP information
  ipv6                IP information
  lacp                Link Aggregation Control Protocol
  list                Print command list
  lldp                Link Layer Discovery Protocol
  log                 Logging control
  loop-protect        Ethernet loop protection
  mac-address-table   Mac address table
  mirror              Port mirroring
  modbus              Modbus TCP slave
  nameserver          DNS Server
  netvision            NetVision protocol
  no                  Negate a command or set its defaults
  ntp                 Configure NTP
  ptpd                IEEE1588 Precision Time Protocol
  qos                 Quality of Service (QoS)
  redundant-ring      Configure redundant ring
  router              Enable a routing process
  service             System service
  smtp-server         SMTP server configuration
  snmp-server         SNMP server
  spanning-tree        spanning tree algorithm
  trunk               Trunk group configuration
  vlan                Virtual LAN
  warning-event        Warning event selection
  write-config        Specify config files to write to
```

## (Port) Interface Configuration

---

When you type **interface IFNAME** in *Global Configuration* mode, you can access *Interface Configuration* mode. In this mode you can configure port settings.

Type the following commands and press the **Enter** key:

- **exit** to return to *Privileged EXEC* mode.
- **?** to see the command list.
- **list** to review the *Interface Configuration* mode commands and corresponding options. The following list is the available commands for the *Port Interface Configuration* mode.

For the complete list of commands and options, refer to [Port Interface Configuration Mode](#) on Page 198.

```
Switch(config)# interface fa1
Switch(config-if)#
  acceptable          Configure 802.1Q acceptable frame types of a port
  auto-negotiation    Enable auto-negotiation state of a given port
  description         Interface specific description
  dot1x              IEEE 802.1x standard access security control
  duplex             Specify duplex mode of operation for a port
  end                End current mode and change to enable mode
  exit               Exit current mode and down to previous mode
  flowcontrol        Set flow-control value for an interface
  garp              General Attribute Registration Protocol
  ingress            IEEE 802.1Q ingress filtering features
  lacp              Link Aggregation Control Protocol
  list              Print command list
  loopback           Specify loopback mode of operation for a port
  mac               MAC interface commands
  mdix              Enable mdix state of a given port
  mtu               Specifies the MTU on a port
  no                Negate a command or set its defaults
  qos               Quality of Service (QoS)
  quit              Exit current mode and down to previous mode
  rate-limit        Rate limit configuration
  shutdown          Shutdown the selected interface
  spanning-tree     spanning-tree protocol
  speed             Specify the speed of a Fast Ethernet port
  switchport        Set switching mode characteristics
```

## (VLAN) Interface Configuration

If you type **interface VLAN VLAN-ID** in *Global Configuration* mode, you can access *VLAN Interface Configuration* mode. In this mode, you can configure the settings for the specific VLAN.

The VLAN interface name of VLAN 1 is VLAN 1, VLAN 2 is VLAN 2.

Type **exit** to return to the previous mode. Type **?** to see the available command list.

For the complete list of commands and options, refer to [VLAN Interface Configuration Mode](#) on Page 200.

```
Switch(config)# interface vlan 1
Switch(config-if)#
  description  Interface specific description
  end          End current mode and change to enable mode
  exit        Exit current mode and down to previous mode
  ip          Interface Internet Protocol config commands
  ipv6       Interface Internet Protocol config commands
  list        Print command list
  no          Negate a command or set its defaults
  quit        Exit current mode and down to previous mode
  shutdown    Shutdown the selected interface
```

## Command Mode Summary

This table is a summary of the five command modes.

Mode: Main Function	Access and Exit Mode	Prompt
<b>User EXEC:</b> This is the first level of access. You can ping, telnet a remote device, and show some basic information.	<ul style="list-style-type: none"> <li>Access <i>User EXEC</i> mode: Login successfully.</li> <li>Exit: <b>exit</b> to logout.</li> <li>Next mode: Type <b>enable</b> to enter <i>Privileged EXEC</i> mode.</li> </ul>	Switch>
<b>Privileged EXEC:</b> Allows you to view current configuration, reset the default values, reload the switch, show system information, save configuration and enter <i>Global Configuration</i> mode.	<ul style="list-style-type: none"> <li>Access <i>Privileged EXEC</i> mode: Type <b>enable</b> in <i>User EXEC</i> mode.</li> <li>Exec: Type <b>disable</b> to exit to <i>User EXEC</i> mode.</li> <li>Type <b>exit</b> to logout.</li> <li>Next mode: Type <b>configure terminal</b> to enter <i>Global Configuration</i> mode.</li> </ul>	Switch#
<b>Global Configuration:</b> Configure all of the features that the ES8508 provides.	<ul style="list-style-type: none"> <li>Access <i>Global Configuration</i> mode: Type <b>configure terminal</b> in <i>Privileged EXEC</i> mode.</li> <li>Exit: Type <b>exit</b> or <b>end</b> or press <b>Ctrl-Z</b> to exit.</li> <li>Next mode: Type <b>interface IFNAME/ VLAN VID</b> to enter <i>Interface Configuration</i> mode.</li> </ul>	Switch(config)#
<b>Port Interface Configuration:</b> Configure port related settings.	<ul style="list-style-type: none"> <li>Access <i>Port Interface Configuration</i> mode: Type <b>interface IFNAME</b> in global configuration mode.</li> <li>Exit: Type <b>exit</b> or <b>Ctrl+Z</b> to <i>Global Configuration</i> mode.</li> <li>Type <b>end</b> to return to <i>Privileged EXEC</i> mode.</li> </ul>	Switch(config-if)#

Mode: Main Function	Access and Exit Mode	Prompt
<b>VLAN Interface Configuration:</b> Configure settings for a specific VLAN.	<ul style="list-style-type: none"> <li>Access <i>VLAN Interface Configuration</i> mode: Type <b>interface VLAN VID</b> in <i>Global Configuration</i> mode.</li> <li>Exit: Type <b>exit</b> or <b>Ctrl+Z</b> to return to <i>Global Configuration</i> mode.</li> <li>Type <b>end</b> to return to <i>Privileged EXEC</i> mode.</li> </ul>	Switch(config-vlan)#

The following are useful commands to save you typing time and to avoid typing errors.

Press ? to see all of the available commands in a mode. It helps you to see the next command you can type.

```
Switch(config)# interface (?)
  IFNAME      Interface's name
  vlan        Select a vlan to configure
```

Type a *Character?* (shown below) to see all of the available commands starting with this character.

```
Switch(config)# a?
  administrator  Administrator account setting
  arp             Set a static ARP entry
```

Press the **Tab** key, which helps you to input the command quicker. If there is only one available command in the next, click the **Tab** key to help finish the typing.

```
Switch# co (tab) (tab)
Switch# configure terminal

Switch(config)# ad (tab)
Switch(config)# administrator
```

Key Combination	Function
<b>Ctrl+C</b>	To stop executing the unfinished command.
<b>Ctrl+S</b>	To lock the screen of the terminal - you cannot input any command.
<b>Ctrl+Q</b>	To unlock the screen which is locked by <b>Ctrl+S</b> .
<b>Ctrl+Z</b>	To exit <i>Configuration</i> mode.

## VTY Configuration Locked (Error Message)

An alert message appears when multiple users are attempting to configure the ES8508. If the administrator is in *Configuration* mode, then the web users cannot change settings. The ES8508 allows only one administrator to configure the switch at a time.

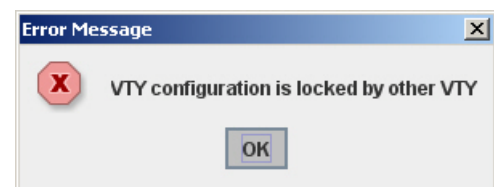





## Basic Settings (CLI)

The Basic Setting group provides you with the ability to configure switch information, IP address, User name/ Password of the system. It also allows you to do firmware upgrade, backup and restore configuration, reload factory default, and reboot the system.

Optionally, you can use the web user interface for configuration, see [Basic Settings](#) on Page 49.

This table provides detailed information about the CLI commands for basic settings.

Switch Setting	
System Name	Switch(config)# hostname DWORD Network name of this system Switch(config)# hostname ES8508 Switch(config)#
System Location	Switch(config)# snmp-server location Minnesota
System Contact	Switch(config)# snmp-server contact support@control.com
Display	Switch# show snmp-server name ES8508 Switch# show snmp-server location Minnesota Switch# show snmp-server contact support@control.com Switch> show version Hardware Information : Product Name : ES8508 MAC Address : 00C04E3A000D Software Information : Loader Version : 1.5.1.4 Firmware Version : 1.3-20121211-16:25:00 Switch# show hardware mac MAC Address: 00C04E3A0001
Admin Password	
User Name and Password	Switch(config)# administrator NAME Administrator account name Switch(config)# administrator admin PASSWORD Administrator account password Switch(config)# administrator admin admin Change administrator account admin and password admin success.
Display	Switch# show administrator Administrator account information name: admin password: admin

IP Configuration	
<p>IP Address/Mask (192.168.250.250, 255.255.255.0)</p> <p>The enabled bit of the subnet mask is used to represent the number displayed in the web user interface. For example, 8 represents: 255.0.0.0, 16 represents: 255.255.0.0, 24 represents:255.255.255.0.</p>	<pre>Switch(config)# int vlan 1 Switch(config-if)# ip address dhcp Switch(config-if)# ip address 192.168.250.8/24 Switch(config-if)# ip dhcp client Switch(config-if)# ip dhcp client renew</pre>
Gateway	Switch(config)# ip route 0.0.0.0/0 192.168.250.254/24
Remove Gateway	Switch(config)# no ip route 0.0.0.0/0 192.168.250.254/24
Display	<pre>Switch# show running-config ..... ! interface vlan1  ip address 192.168.250.8/24  no shutdown ! ip route 0.0.0.0/0 192.168.250.254/24 !</pre>
Time Setting	
NTP Server	<pre>Switch(config)# ntp peer enable disable primary secondary Switch(config)# ntp peer primary IPADDR Switch(config)# ntp peer primary 192.168.250.250</pre>
Time Zone	<pre>Switch(config)# clock timezone 26 Sun Jan 1 04:13:24 2006 (GMT) Greenwich Mean Time: Dublin, Edinburgh, Lisbon, London</pre> <p><b>Note:</b> By typing <i>clock timezone?</i>, you can see the <i>timezone</i> list. Then choose the number of the <i>timezone</i> you want to select.</p>
IEEE 1588	<pre>Switch(config)# ptpd run &lt;cr&gt; preferred-clock Preferred Clock slave Run as slave</pre>

DHCP Server	
DHCP Server configuration	<pre> Enable DHCP Server on ES8508 Switch Switch# Switch# configure terminal Switch(config)# router dhcp Switch(config-dhcp)# service dhcp  Configure DHCP network address pool Switch(config-dhcp)#network 50.50.50.0/4 -(network/mask) Switch(config-dhcp)#default-router 50.50.50.1                     </pre>
Lease time configure	<pre> Switch(config-dhcp)#lease 300 (300 sec)                     </pre>
DHCP Relay Agent	<pre> Enable DHCP Relay Agent Switch# Switch# configure terminal Switch(config)# router dhcp Switch(config-dhcp)# service dhcp Switch(config-dhcp)# ip dhcp relay information option &lt;cr&gt;   circuit-id  Configure Circuit-ID   remote-id   Configure Remote-ID Switch(config-dhcp)# ip dhcp relay information option   option Option82 Switch(config-dhcp)# ip dhcp relay information option                     </pre>
Show DHCP server information	<pre> Switch# show ip dhcp server statistics DHCP Server ON Address Pool 1   network:192.168.17.0/24   default-router:192.168.17.254   lease time:300 Excluded Address List   IP Address ----- (list excluded address) Manual Binding List   IP Address      MAC Address ----- (list IP &amp; MAC binding entry) Leased Address List   IP Address      MAC Address      Leased Time Remains ----- (list leased Time remain information for each entry)                     </pre>

DHCP Server (cont.)	
DHCP Commands	<pre>Switch(config)# router dhcp Switch(config-dhcp)#   default-router DHCP Default Router end          Exit current mode and down to previous enable mode exit        Exit current mode and down to previous mode ip          IP protocol lease      DHCP Lease Time list       Print command list network    dhcp network no         Remove quit      Exit current mode and down to previous mode service    Enable service</pre>
DHCP Server Enable	<pre>Switch(config-dhcp)# service dhcp &lt;cr&gt;</pre>
DHCP Server IP Pool (Network/Mask)	<pre>Switch(config-dhcp)# network   A.B.C.D/M network/mask ex. 10.10.1.0/24 Switch(config-dhcp)# network 192.168.10.0/24</pre>
DHCP Server – Default Gateway	<pre>Switch(config-dhcp)# default-router   A.B.C.D address Switch(config-dhcp)# default-router 192.168.10.254</pre>
DHCP Server – lease time	<pre>Switch(config-dhcp)# lease   TIME second Switch(config-dhcp)# lease 1000 (1000 second)</pre>
DHCP Server – Excluded Address	<pre>Switch(config-dhcp)# ip dhcp excluded-address   A.B.C.D IP address Switch(config-dhcp)# ip dhcp excluded-address 192.168.10.123 &lt;cr&gt;</pre>
DHCP Server – Static IP and MAC binding	<pre>Switch(config-dhcp)# ip dhcp static   MACADDR MAC address Switch(config-dhcp)# ip dhcp static 00C0.4E3A.0001   A.B.C.D leased IP address Switch(config-dhcp)# ip dhcp static 00C0.4E3A.0001   192.168.10.99</pre>
DHCP Relay – Enable DHCP Relay	<pre>Switch(config-dhcp)# ip dhcp relay information   option Option82   policy Option82 Switch(config-dhcp)# ip dhcp relay information option</pre>

DHCP Server (cont.)	
DHCP Relay – DHCP policy	<pre>Switch(config-dhcp)# ip dhcp relay information policy drop      Relay Policy keep      Drop/Keep/Replace option82 field replace  Switch(config-dhcp)# ip dhcp relay information policy drop &lt;cr&gt; Switch(config-dhcp)# ip dhcp relay information policy keep &lt;cr&gt; Switch(config-dhcp)# ip dhcp relay information policy replace &lt;cr&gt;</pre>
DHCP Relay – IP Helper Address	<pre>Switch(config-dhcp)# ip dhcp helper-address A.B.C.D Switch(config-dhcp)# ip dhcp helper-address 192.168.10.200</pre>
Reset DHCP Settings	<pre>Switch(config-dhcp)# ip dhcp reset &lt;cr&gt;</pre>
Backup and Restore	
Backup Startup Configuration File	<pre>Switch# copy startup-config tftp: 192.168.250.33/ default.conf Writing Configuration [OK]</pre> <p><b>Note:</b> To backup the latest startup configuration file, you should save current settings to flash first. You can refer to <a href="#">Save to Flash</a> on Page 129 to see how to save settings to the flash.</p> <p><i>In the example above, 192.168.250.33 is the TFTP server's IP and default.conf is name of the configuration file. Your environment may use different IP addresses or different file name. Type target TFTP server IP or file name in this command.</i></p>
Restore Configuration	<pre>Switch# copy tftp: 192.168.250.33/default.conf startup- config</pre>
Show Startup Configuration	<pre>Switch# show startup-config</pre>
Show Running Configuration	<pre>Switch# show running-config</pre>



## Port Configuration (CLI)

---

The Port Configuration group allows you to enable/disable port state, or configure port auto-negotiation, speed, duplex, flow control, rate limit control, and port aggregation settings. It also allows you to view port status and aggregation information.

Optionally, you can use the web user interface for configuration, see [Port Configuration](#) on Page 70.

This table provides detailed information about the CLI commands for port configuration.

Port Control	
Port Control - State	Switch(config-if)# shutdown -> Disable port state Port1 Link Change to DOWN interface fastethernet1 is shutdown now.
	Switch(config-if)# no shutdown -> Enable port state Port1 Link Change to DOWN Port1 Link Change to UP interface fastethernet1 is up now. Switch(config-if)# Port1 Link Change to UP
Port Control - Auto Negotiation	Switch(config)# interface fa1 Switch(config-if)# auto-negotiation Auto-negotiation of port 1 is enabled!
Port Control - Force Speed/ Duplex	Switch(config-if)# speed 100 Port1 Link Change to DOWN set the speed mode ok! Switch(config-if)# Port1 Link Change to UP  Switch(config-if)# duplex full set the duplex mode ok!
Port Control - Flow Control	Switch(config-if)# flowcontrol on Flowcontrol on for port 1 set ok!  Switch(config-if)# flowcontrol off Flowcontrol off for port 1 set ok!



Port Status	
Port Status	<pre>Switch# show interface fa1 Interface fastethernet1   Administrative Status : Enable   Operating Status : Connected   Duplex : Full   Speed : 100   Flow Control :off   Default Port VLAN ID: 1   Ingress Filtering : Disabled   Acceptable Frame Type : All   Port Security : Disabled   Auto Negotiation : Disable   Loopback Mode : None   STP Status: forwarding   Default CoS Value for untagged packets is 0.   Mdx mode is Disable.   Medium mode is Copper.</pre> <p><b>Note:</b> Administrative Status -&gt; Port state of the port. Operating status -&gt; Current status of the port. Duplex -&gt; Duplex mode of the port. Speed -&gt; Speed mode of the port. Flow control -&gt; Flow Control status of the port.</p>
Rate Control	
Rate Control – Ingress or Egress	<pre>Switch(config-if)# rate-limit   egress   Outgoing packets   ingress  Incoming packets</pre> <p><b>Note:</b> To enable rate control, you should select the Ingress or Egress rule first; then assign the packet type and bandwidth.</p>
Rate Control – Filter Packet Type	<pre>Switch(config-if)# rate-limit ingress mode   all           Limit all frames   broadcast     Limit Broadcast frames   flooded-unicast Limit Broadcast, Multicast and flooded unicast frames   multicast     Limit Broadcast and Multicast frames</pre> <pre>Switch(config-if)# rate-limit ingress mode broadcast Set the ingress limit mode broadcast ok.</pre>
Rate Control – Bandwidth	<pre>Switch(config-if)# rate-limit ingress bandwidth   &lt;0-100&gt; Limit in megabits per second (0 is no limit)</pre> <pre>Switch(config-if)# rate-limit ingress bandwidth 8 Set the ingress rate limit 8Mbps for Port 1.</pre>

Port Trunking	
Display – LACP	<pre> Switch# show lacp internal LACP group 1 internal information:       LACP Port   Admin   Oper   Port Port  Priority   Key     Key     State -----       8           1       8       8       0x45       9           1       9       9       0x45      10           1      10      10      0x45  LACP group 2 is inactive LACP group 3 is inactive LACP group 4 is inactive                     </pre>
Display – Trunk	<pre> Switch# show trunk group 1 FLAGS:      I -&gt; Individual          P -&gt; In channel             D -&gt; Port Down  Trunk Group GroupID  Protocol  Ports -----+-----+-----       1      LACP      8(D) 9(D) 10(D) Switch# show trunk group 2 FLAGS:      I -&gt; Individual          P -&gt; In channel             D -&gt; Port Down  Trunk Group GroupID  Protocol  Ports -----+-----+-----       2      Static    6(D) 7(P) Switch#                     </pre>

## Network Redundancy (CLI)

---

---

It is critical for industrial applications that the network remains running at all times. The ES8508 supports:

- Standard Rapid Spanning Tree Protocol (STP) and Rapid Spanning Tree Protocol (RSTP)  
The ES8508 supports RSTP versions IEEE 802.1D-2004, IEEE 802.1D-1998 STP, and IEEE 802.1w RSTP.
- Multiple Spanning Tree Protocol (MSTP)  
MSTP implements IEEE 802.1s, which uses RSTP for rapid convergence, enables VLANs to be grouped into a spanning-tree instance, with each instance having a spanning-tree topology independent of other spanning-tree instances. This architecture provides multiple forwarding paths for data traffic, enables load balancing, and reduces the number of spanning-tree instances required to support a large number of VLANs. MSTP was originally defined in the IEEE 802.1s and later merged into the IEEE 802.1Q-2003 specification.
- Redundant Ring  
The Redundant Ring features 0 ms for restore and about 5 ms for fail over for copper.
- Rapid Dual Homing (RDH)  
Advanced RDH technology allows the ES8508 to connect with a core managed switch easily and conveniently. With RDH technology, you can also couple several Rapid Super Rings or RSTP groups together, which is also known as Auto Ring Coupling.

Optionally, you can use the web user interface for configuration, see [Network Redundancy](#) on Page 76.

This table provides detailed information about the CLI command lines for network redundancy.

<b>Global (STP, RSTP, and MSTP)</b>	
Enable	Switch(config)# spanning-tree enable
Disable	Switch(config)# spanning-tree disable
Mode	<pre>Switch(config)# spanning-tree mode rst the rapid spanning-tree protocol (802.1w) stp the spanning-tree prtocol (802.1d) mst the multiple spanning-tree protocol (802.1s)</pre> <pre>Switch(config)# spanning-tree mode Switch(config)# spanning-tree mode mst Spanning-Tree Mode change to be MSTP (802.1s)</pre> <pre>Switch(config)# spanning-tree mode stp Spanning-Tree Mode change to be STP(802.1d) .</pre> <pre>Switch(config)# spanning-tree mode rst Spanning-Tree Mode change to be RSTP(802.1w) .</pre> <pre>Switch(config)# spanning-tree mode mst Spanning-Tree Mode change to be MSTP(802.1s).</pre>
Bridge Priority	<pre>Switch(config)# spanning-tree priority &lt;0-61440&gt; the value of bridge priority in multiple of 4096 Switch(config)# spanning-tree priority 4096</pre>
Bridge Times	<pre>Switch(config)# spanning-tree bridge-times (forward Delay) (max-age) (Hello Time) Switch(config)# spanning-tree bridge-times 15 20 2</pre> <p><i>This command allows you configure all the timing in one time.</i></p>
Forward Delay	<pre>Switch(config)# spanning-tree forward-time &lt;4-30&gt; the value of forward delay time in seconds Switch(config)# spanning-tree forward-time 15</pre>
Max Age	<pre>Switch(config)# spanning-tree max-age &lt;6-40&gt; the value of message maximum age time in seconds Switch(config)# spanning-tree max-age 20</pre>
Hello Time	<pre>Switch(config)# spanning-tree hello-time &lt;1-10&gt; the value of hello time in seconds Switch(config)# spanning-tree hello-time 2</pre>

MSTP	
Enter the MSTP Configuration Tree	<pre> Switch(config)# spanning-tree mst   MSTMAP          the mst instance number or range   configuration    enter mst configuration mode   forward-time    the forward delay time   hello-time      the hello time   max-age         the message maximum age time   max-hops        the maximum hops   sync            sync port state of exist vlan entry Switch(config)# spanning-tree mst configuration Switch(config)# spanning-tree mst configuration Switch(config-mst)#   abort           exit current mode and discard all changes   end             exit current mode, change to enable mode and apply all changes   exit           exit current mode and apply all changes   instance       the mst instance   list           Print command list   name           the name of mst region   no             Negate a command or set its defaults   quit          exit current mode and apply all changes   revision       the revision of mst region   show          show mst configuration </pre>
Region Configuration	<pre> Region Name: Switch(config-mst)# name   NAME the name string Switch(config-mst)# name control Region Revision: Switch(config-mst)# revision   &lt;0-65535&gt; the value of revision Switch(config-mst)# revision 65535 </pre>
Mapping Instance to VLAN (Ex: Mapping VLAN 2 to Instance 1)	<pre> Switch(config-mst)# instance   &lt;1-15&gt; target instance number Switch(config-mst)# instance 1 vlan   VLANMAP target vlan number(ex.10) or range(ex.1-10) Switch(config-mst)# instance 1 vlan 2 </pre>

MSTP (cont.)	
Display Current MST Configuration	<pre>Switch(config-mst)# show current Current MST configuration Name      [control] Revision  65535 Instance  Vlans Mapped -----  ----- 0         1,4-4094 1         2 2         3 -----  Config HMAC-MD5 Digest: 0xB41829F9030A054FB74EF7A8587FF58D -----</pre>
Remove Region Name	<pre>Switch(config-mst)# no name      name configure revision  revision configure instance  the mst instance Switch(config-mst)# no name</pre>
Remove Instance example	<pre>Switch(config-mst)# no instance &lt;1-15&gt; target instance number Switch(config-mst)# no instance 2</pre>
Show Pending MST Configuration	<pre>Switch(config-mst)# show pending Pending MST configuration Name      []      (-&gt;The name is removed by no name) Revision  65535 Instance  Vlans Mapped -----  ----- 0         1,3-4094 1         2      (-&gt;Instance 2 is removed by no instance 2) -----  Config HMAC-MD5 Digest: 0x3AB68794D602FDF43B21C0B37AC3BCA8 -----</pre>
Apply the setting and go to the configuration mode	<pre>Switch(config-mst)# quit apply all mst configuration changes Switch(config)#</pre>
Apply the setting and go to the global mode	<pre>Switch(config-mst)# end apply all mst configuration changes Switch#</pre>

MSTP (Continued)	
<p>Abort the Setting and go to the configuration mode.</p> <p>Show Pending to see the new settings are not applied.</p>	<pre>Switch(config-mst)# abort discard all mst configuration changes Switch(config)# spanning-tree mst configuration Switch(config-mst)# show pending Pending MST configuration Name      [control] (-&gt;The name is not applied after Abort settings.) Revision  65535 Instance  Vlans Mapped ----- 0         1,4-4094 1         2 2         3 (-&gt; The instance is not applied after Abort settings.) ----- Config HMAC-MD5 Digest: 0xAC36177F50283CD4B83821D8AB26DE62 -----</pre>
RSTP	
<p>System RSTP Setting</p>	<p>The mode should be rstp, timings can be configured in the global settings listed in the previous examples.</p>
Port Configuration Mode	
<p>Port Configuration</p>	<pre>Switch(config)# interface 1 Switch(config-if)# spanning-tree   bpdudfilter      a secure BPDU process on edge-port interface   bpduguard        a secure response to invalid configurations (received BPDU sent by self)   cost              change an interface's spanning-tree port path cost   edge-port         interface attached to a LAN segment that is at the end of a bridged LAN or to an end node   link-type         the link type for the Rapid Spanning Tree   mst               the multiple spanning-tree   port-priority     the spanning tree port priority</pre>
<p>Port Path Cost</p>	<pre>Switch(config-if)# spanning-tree cost &lt;1-200000000&gt; 16-bit based value range from 1-65535, 32-bit based value range from 1-200,000,000 Switch(config-if)# spanning-tree cost 200000</pre>
<p>Port Priority</p>	<pre>Switch(config-if)# spanning-tree port-priority &lt;0-240&gt; Number from 0 to 240, in multiple of 16 Switch(config-if)# spanning-tree port-priority 128</pre>
<p>Link Type - Auto</p>	<pre>Switch(config-if)# spanning-tree link-type auto</pre>
<p>Link Type - P2P</p>	<pre>Switch(config-if)# spanning-tree link-type point-to-point</pre>

Port Configuration Mode (Continued)	
Link Type – Share	Switch(config-if)# spanning-tree link-type shared
Edge Port	Switch(config-if)# spanning-tree edge-port enable Switch(config-if)# spanning-tree edge-port disable
MSTP Port Configuration	Switch(config-if)# spanning-tree mst MSTMAP cost <1-200000000> the value of mst instance port cost Switch(config-if)# spanning-tree mst MSTMAP port-priority <0-240> the value of mst instance port priority in multiple of 16
Global Information	
Active Information	<pre>Switch# show spanning-tree active Spanning-Tree : Enabled          Protocol : MSTP Root Address : 00C0.4E3A.0001    Priority : 32768 Root Path Cost : 0                Root Port : N/A Root Times : max-age 20, hello-time 2, forward-delay 15 Bridge Address : 00C0.4E3A.0001  Priority : 32768 Bridge Times : max-age 20, hello-time 2, forward-delay 15 BPDU transmission-limit : 3  Port      Role      State      Cost      Prio.Nbr  Type      Aggregated ----- fa1  Designated Forwarding  200000    128.1    P2P(RSTP)  N/A fa2  Designated Forwarding  200000    128.2    P2P(RSTP)  N/A</pre>
RSTP Summary	<pre>Switch# show spanning-tree summary Spanning-Tree : Enabled          Protocol : MSTP Root Address : 00c0.4e3A.004f    Priority : 32768 Root Path Cost : 400000          Root Port : 10 Root Times : max-age 20, hello-time 2, forward-delay 15 Bridge Address 00c0.4e3A.0001    Priority : 32768 Bridge Times : max-age 20, hello-time 2, forward-delay 15 BPDU transmission-limit : 3 BPDU Skewing Detection : Disabled Backbonefast : Disabled Topology Change Flag : False     Topology Change Detected Flag : False Topology Change Count : 571      Last Topology Change from : 0000.0000.0000 Timers: hello 0, topology change 0  Summary of connected spanning tree ports : Port-State Summary Blocking  Listening  Learning  Forwarding  Disabled ----- 1         0         0         1           8  Port Link-Type Summary AutoDetected  PointToPoint  SharedLink  EdgePort ----- 10            0            0           8</pre>



Global Information (Continued)	
Port Info	<pre>Switch# show spanning-tree interface fal Interface fastethernet1 of Bridge is Alternate Blocking Edge Port : Edge (Non-Edge)          BPDU Filter : Disabled Link Type : Auto (Point-to-point)    BPDU Guard : Disabled Timers : message-age 4, forward-delay 0 BPDUs : sent 26, received 34037 TCNs : sent 0, received 0 Message Expired Count : 0             Forward Transition Count : 8 Aggregation Group: N/A Type: N/A Aggregated with : N/A  Port information  port id 128.6          priority 128 cost 200000 Designated root  address 00c0.4e3a.004f priority 32768 cost 200000 Designated bridge address 00c0.4e3a.0007 priority 32768 port id 128.5</pre>
MSTP Information	
MSTP Configuration	<pre>Switch# show spanning-tree mst configuration Current MST configuration (MSTP is Running) Name      [comtrol] Revision  65535 Instance  Vlans Mapped ----- 0         1,4-4094 1         2 2         3 -----  Config HMAC-MD5 Digest: 0xAc36177F50283CD4B83821D8AB26DE62 -----</pre>
Display all MST Information	<pre>Switch# show spanning-tree mst ##### MST00  vlans mapped: 1,4-4094 Bridge      address 00C0.4E3A.0001  priority 32768 (sysid 0) Root        this switch for CST and IST Configured  max-age 2, hello-time 15, forward-delay 20, max-hops 20  Port  Role      State      Cost      Prio.Nbr  Type ----- fal  Designated Forwarding 200000 128.1 P2P Internal(MSTP) fa2  Designated Forwarding 200000 128.2 P2P Internal(MSTP)  ##### MST01  vlans mapped: 2 Bridge      address 00C0.4E3A.0001  priority 32768 (sysid 1) Root        this switch for MST01  Port  Role      State      Cost      Prio.Nbr  Type ----- fal  Designated Forwarding 200000 128.1 P2P Internal(MSTP) fa2  Designated Forwarding 200000 128.2 P2P Internal(MSTP)</pre>

MSTP Information (Continued)	
Display all MST Information	<pre>Switch# show spanning-tree mst ##### MST00   vlans mapped: 1-4094 Bridge         address 00c0.4e30.0001  priority 32768 (sysid 0) Root           address 00c0.4e2c.004f  priority 32768 (sysid 0)                 port      10                path cost 400000  Regional root  this switch Operational    max-age 2, hello-time 15, forward-delay 20 Configured     max-age 2, hello-time 15, forward-delay 20, max-hops 20  Port      Role      State      Cost      Prio.Nbr      Type ----- fa2       Alternate Blocking   200000     128.6       P2P Bound(RSTP) fa1       Root      Forwarding 200000     128.10      P2P Bound(RSTP)</pre>
MSTP Root Information	<pre>Switch# show spanning-tree mst root MST   Root      Root      Root      Root      Max  Hello  Fwd Instance Address      Priority   Cost      Port      age    dly ----- MST00 00C0.4E3A.0001 32768    0   N/A    20    2    15 MST01 00C0.4E3A.0001 32768    0   N/A    20    2    15 MST02 00C0.4E3A.0001 32768    0   N/A    20    2    15</pre>
MSTP Instance Information	<pre>Switch# show spanning-tree mst 1 ##### MST01   vlans mapped: 2 Bridge         address 00C0.4E3A.0001  priority 32768 (sysid 1) Root           this switch for MST01  Port      Role      State      Cost      Prio.Nbr      Type ----- fa1       Designated Forwarding 200000     128.1       P2P Internal(MSTP) fa2       Designated Forwarding 200000     128.2       P2P Internal(MSTP)</pre>
MSTP Port Information	<pre>Switch# show spanning-tree mst interface 1 Interface fastethernet1 of MST00 is Designated Forwarding Edge Port : Edge (Edge)          BPDU Filter : Disabled Link Type : Auto (Point-to-point) BPDU Guard : Disabled Boundary : Internal(MSTP) BPDUs : sent 6352, received 0  Instance  Role      State      Cost      Prio.Nbr      Vlans mapped ----- 0         Designated Forwarding 200000     128.1       1,4-4094 1         Designated Forwarding 200000     128.1       2 2         Designated Forwarding 200000     128.1       3</pre>

Redundant Ring	
Create or configure a Ring	<pre>Switch(config)# redundant-ring 1 Ring 1 created Switch(config-redundant-ring)#</pre> <p><b>Note:</b> 1 is the target Ring ID which is going to be created or configured.</p>
Super Ring Version	<pre>Switch(config-redundant-ring)# version default          set default to Redundant ring rapid-super-ring rapid super ring super-ring       super ring</pre> <pre>Switch(config-redundant-ring)# version rapid-super-ring</pre>
Priority	<pre>Switch(config-redundant-ring)# priority &lt;0-255&gt; valid range is 0 to 255 default  set default</pre> <pre>Switch(config-redundant-ring)# super-ring priority 100</pre>
Ring Port	<pre>Switch(config-redundant-ring)# port IFLIST Interface list, ex: fa1,fa3-5, cost    path cost</pre> <pre>Switch(config-redundant-ring)# port fa1,fa2</pre>
Ring Info	
Ring Info	<pre>Switch# show redundant-ring [Ring ID] [Ring1] Ring1 Current Status : Disabled Role           : Disabled Ring Status    : Abnormal Ring Manager   : 0000.0000.0000 Blocking Port  : N/A Giga Copper    : N/A Configuration : Version        : Super Ring Priority        : 128 Ring Port      : fa1, fa2 Path Cost      : 100, 200 Dual-Homing II : Disabled Statistics : Watchdog sent   0, received   0, missed   0 Link Up sent    0, received   0 Link Down sent  0, received   0 Role Transition count 0 Ring State Transition count 1</pre> <p><i>Ring ID</i> is optional. If the ring ID is typed, this command only displays the information of the target Ring.</p>

## VLAN (CLI)

A Virtual LAN (VLAN) is a logical grouping of nodes for the purpose of limiting a broadcast domain to specific members of a group without physically grouping the members. The VLAN allows you to isolate network traffic so that only members of the VLAN could receive traffic from the same VLAN members. Basically, creating a VLAN from a switch is the logical equivalent of physically reconnecting a group of network devices to another Layer 2 switch, without actually disconnecting these devices from their original switches.

The ES8508 supports IEEE 802.1Q VLAN, which is also known as Tag-Based VLAN. This Tag-Based VLAN allows a VLAN to be created across different switches. IEEE 802.1Q tag-based VLAN makes use of VLAN control information stored in a VLAN header attached to IEEE 802.3 packet frames. This tag contains a VLAN Identifier (VID) that indicates which VLAN a frame belongs to. Since each switch only has to check a frame's tag, without the need to dissect the contents of the frame, this also saves a lot of computing resources within the switch.

Optionally, you can use the web user interface for configuration, see [VLAN](#) on Page 89.

The following table provides detailed information about command lines for the VLAN.

VLAN Port Configuration	
VLAN Port PVID	Switch(config-if)# switchport trunk native vlan 2 Set port default vlan id to 2 success
Port Accept Frame Type	Switch(config)# inter fal Switch(config-if)# acceptable frame type all any kind of frame type is accepted! Switch(config-if)# acceptable frame type vlantaggedonly only vlan-tag frame is accepted!
Ingress Filtering (for Fast Ethernet Port 1)	Switch(config)# interface fal Switch(config-if)# ingress filtering enable ingress filtering enable Switch(config-if)# ingress filtering disable ingress filtering disable
Egress rule – Untagged (for VLAN 2)	Switch(config-if)# switchport access vlan 2 switchport access vlan - success
Egress rule – Tagged (for VLAN 2)	Switch(config-if)# switchport trunk allowed vlan add 2
Display – Port Ingress Rule (PVID, Ingress Filtering, Acceptable Frame Type)	Switch# show interface fal Interface fastethernet1 Administrative Status : Enable Operating Status : Not Connected Duplex : Auto Speed : Auto Flow Control :off Default Port VLAN ID: 2 Ingress Filtering : Disabled Acceptable Frame Type : All Port Security : Disabled Auto Negotiation : Enable Loopback Mode : None STP Status: disabled Default CoS Value for untagged packets is 0. Mdix mode is Auto. Medium mode is Copper.

VLAN Port Configuration (continued)	
Display – Port Egress Rule (Egress rule, IP address, status)	<pre>Switch# show running-config ..... ! interface fastethernet1   switchport access vlan 1   switchport access vlan 3   switchport trunk native vlan 2 ..... interface vlan1   ip address 192.168.250.8/24   no shutdown</pre>
VLAN Configuration	
Create VLAN (2)	<pre>Switch(config)# vlan 2 vlan 2 success  Switch(config)# interface vlan 2 Switch(config-if)#</pre> <p><b>Note:</b> <i>In the CLI configuration, you should first create a VLAN interface. Then you can start to add/remove ports. The default status of the created VLAN is unused until you add member ports to it.</i></p>
Remove VLAN	<pre>Switch(config)# no vlan 2 no vlan success</pre> <p><b>Note:</b> <i>You can only remove the VLAN when the VLAN is in unused mode.</i></p>
VLAN Name	<pre>Switch(config)# vlan 2 vlan 2 has exists Switch(config-vlan)# name v2  Switch(config-vlan)# no name</pre> <p><b>Note:</b> <i>Use no name to change the name to default name, VLAN VID.</i></p>
VLAN description	<pre>Switch(config)# interface vlan 2 Switch(config-if)# Switch(config-if)# description this is the VLAN 2  Switch(config-if)# no description -&gt;Delete the description.</pre>
IP address of the VLAN	<pre>Switch(config)# interface vlan 2 Switch(config-if)# Switch(config-if)# ip address 192.168.250.18/24 Switch(config-if)# no ip address 192.168.250.8/24 -&gt;Delete the IP address</pre>
Create multiple VLANs (VLAN 5-8)	<pre>Switch(config)# interface vlan 5-8</pre>
Shutdown VLAN	<pre>Switch(config)# interface vlan 2 Switch(config-if)# shutdown Switch(config-if)# no shutdown -&gt;Turn on the VLAN</pre>

VLAN Configuration (continued)	
Display – VLAN table	<pre>Switch# sh vlan VLAN Name      Status  Trunk Ports      Access Ports ----- 1      VLAN1   Static          -             fa1-7 2      VLAN2   Unused          - 4</pre>
Display – VLAN interface information	<pre>Switch# show interface vlan1 interface vlan1 is up, line protocol detection is disabled index 14 metric 1 mtu 1500 &lt;UP,BROADCAST,RUNNING,MULTICAST&gt; HWaddr: 00:c0:4e:ff:01:b0 inet 192.168.250.100/24 broadcast 192.168.250.255 input packets 639, bytes 38248, dropped 0, multicast packets 0 input errors 0, length 0, overrun 0, CRC 0, frame 0, fifo 0, missed 0 output packets 959, bytes 829280, dropped 0 output errors 0, aborted 0, carrier 0, fifo 0, heartbeat 0, window 0 collisions 0</pre>
GVRP Configuration	
GVRP enable/disable	<pre>Switch(config)# gvrp mode disable Disable GVRP feature globally on the switch enable Enable GVRP feature globally on the switch Switch(config)# gvrp mode enable Gvrp is enabled on the switch!</pre>
Configure GVRP timer	<pre>Switch(config)# inter fa1 Switch(config-if)# garp timer &lt;10-10000&gt;</pre>
Join timer /Leave timer/ LeaveAll timer	<pre>Switch(config-if)# garp timer 20 60 1000 <b>Note: The unit of this timer is centiseconds.</b></pre>
Management VLAN	
Management VLAN	<pre>Switch(config)# int vlan 1 (Go to management VLAN) Switch(config-if)# no shutdown</pre>
Display	<pre>Switch# show running-config ... ! interface vlan1 ip address 192.168.250.17/24 ip igmp no shutdown ! ...</pre>

## Private VLAN (CLI)

A private VLAN helps to resolve the primary VLAN ID shortage, client ports' isolation and network security issues. The Private VLAN features provides primary and secondary VLANs within a single switch.

**Primary VLAN:** The uplink port is usually a member of the primary VLAN. A primary VLAN contains promiscuous ports that can communicate with Secondary VLANs.

**Secondary VLAN:** The client ports are usually defined within secondary VLAN. The secondary VLAN includes Isolated and Community VLANs. The client ports can be isolated VLANs or can be grouped in the same Community VLAN. The ports within the same community VLAN can communicate with each other, however, the isolated VLAN ports cannot.

Optionally, you can use the web user interface for configuration, see [Private VLAN](#) on Page 97.

The following table provides detailed information about command lines for private VLAN port configuration, VLAN configuration, and VLAN table display.

Private VLAN Configuration	
Create VLAN	<pre>Switch(config)# vlan 2 vlan 2 success Switch(config-vlan)#     end           End current mode and change to enable mode     exit          Exit current mode and down to previous mode     list          Print command list     name          Assign a name to vlan     no            no     private-vlan Configure a private VLAN</pre>
Private VLAN Type	<p><i>Go to the VLAN you want configure first.</i></p> <pre>Switch(config)# vlan (VID)</pre>
Choose the Types	<pre>Switch(config-vlan)# private-vlan     community Configure the VLAN as an community private VLAN     isolated   Configure the VLAN as an isolated private VLAN     primary    Configure the VLAN as a primary private VLAN</pre>
Primary Type	<pre>Switch(config-vlan)# private-vlan primary &lt;cr&gt;</pre>
Isolated Type	<pre>Switch(config-vlan)# private-vlan isolated &lt;cr&gt;</pre>
Community Type	<pre>Switch(config-vlan)# private-vlan community &lt;cr&gt;</pre>

Private VLAN Port Configuration	
Go to the port configuration	<pre>Switch(config)# interface (port_number, ex: fa1) Switch(config-if)# switchport private-vlan   host-association Set the private VLAN host association   mapping          map primary VLAN to secondary VLAN</pre>
Private VLAN Port Type	<pre>Switch(config-if)# switchport mode   private-vlan Set private-vlan mode Switch(config-if)# switchport mode private-vlan   host          Set the mode to private-vlan host   promiscuous  Set the mode to private-vlan promiscuous Switch(config-if)# switchport mode private-vlan promiscuous &lt;cr&gt;</pre>
Promiscuous Port Type	<pre>Switch(config-if)# switchport mode private-vlan host &lt;cr&gt;</pre>
Host Port Type	
Private VLAN Port Configuration PVLAN Port Type	<pre>Switch(config)# interface fa1 Switch(config-if)# switchport mode private-vlan host</pre>
Host Association primary to secondary  (The command is only available for host port.)	<pre>Switch(config-if)# switchport private-vlan host-association   &lt;2-4094&gt; Primary range VLAN ID of the private VLAN port   association Switch(config-if)# switchport private-vlan host-association 2   &lt;2-4094&gt; Secondary range VLAN ID of the private VLAN port   association Switch(config-if)# switchport private-vlan host-association 2 3</pre>
Mapping primary to secondary VLANs  (This command is only available for promiscuous port)	<pre>Switch(config)# interface fa1 Switch(config-if)# switchport mode private-vlan promiscuous Switch(config-if)# switchport private-vlan mapping 2 add 3 Switch(config-if)# switchport private-vlan mapping 2 add 4 Switch(config-if)# switchport private-vlan mapping 2 add 5</pre>
Private VLAN Information	
Private VLAN Information	<pre>Switch# show vlan private-vlan FLAGS:      I -&gt; Isolated          P -&gt; Promiscuous            C -&gt; Community Primary  Secondary  Type          Ports -----  - 2        3          Isolated     fa1(P),fa2(I) 2        4          Community    fa2(P),fa3(C) 2        5          Community    fa2(P),fa1(C),fa3(I) 10       -          -            -</pre>



**Private VLAN Information (Continued)**

Running Config Information	Switch# show run Building configuration...
Private VLAN Type	Current configuration: hostname Switch vlan learning independent ! vlan 1 ! vlan 2 private-vlan primary ! vlan 3 private-vlan isolated ! vlan 4 private-vlan community ! vlan 5 private-vlan community ! ..... ..... interface fastethernet7 switchport access vlan add 2,5 switchport trunk native vlan 5 switchport mode private-vlan host switchport private-vlan host-association 2 5 ! interface fastethernet switchport access vlan add 2,4 switchport trunk native vlan 4 switchport mode private-vlan host switchport private-vlan host-association 2 4 ..... .....
Private VLAN Port Information	

Private VLAN Information (Continued)	
PVLAN Type	<pre>Switch# show vlan private-vlan type Vlan Type          Ports ----- 2    primary       fa3 3    isolated      fa2 4    community     fa1 5    community     fa4,fa5</pre>
Host List	<pre>Switch# show vlan private-vlan port-list Ports Mode        Vlan ----- 1    normal        - 2    normal        - 3    normal        - 4    normal        - 5    normal        - 6    normal        - 7    host          5 8    host          4</pre>

## Traffic Prioritization (CLI)

Quality of Service (QoS) provides a traffic prioritization mechanism which allows you to deliver better service to certain flows. QoS can also help to alleviate congestion problems and ensure high-priority traffic is delivered first. This section allows you to configure Traffic Prioritization settings for each port with regard to setting priorities.

ES8508 QoS supports four physical queues, weighted fair queuing (WRR) and Strict Priority scheme, that follows the IEEE 802.1p CoS tag and IPv4 TOS/DiffServ information to prioritize the traffic of your industrial network.

Optionally, you can use the web user interface for configuration, see [Traffic Prioritization](#) on Page 100. This table provides detailed information about command lines for traffic prioritization configuration

QoS Setting	
Queue Scheduling – Strict Priority	Switch(config)# qos queue-sched sp Strict Priority wrr Weighted Round Robin (Use an 8,4,2,1 weight) Switch(config)# qos queue-sched sp  
Queue Scheduling - WRR	Switch(config)# qos queue-sched wrr
Port Setting – CoS (Default Port Priority)	Switch(config)# interface fa1 Switch(config-if)# qos cos DEFAULT-COS Assign an priority (7 highest) Switch(config-if)# qos cos 7 The default port CoS value is set 7 ok.  <i>Note: When change the port setting, you should select the specific port first. fa1 means Fast Ethernet port 1.</i>
Port Setting – Trust Mode- CoS Only	Switch(config)# interface fa1 Switch(config-if)# qos trust cos The port trust is set CoS only ok.
Port Setting – Trust Mode- CoS First	Switch(config)# interface fa1 Switch(config-if)# qos trust cos-first The port trust is set CoS first ok.
Port Setting – Trust Mode- DSCP Only	Switch(config)# interface fa1 Switch(config-if)# qos trust dscp The port trust is set DSCP only ok.
Port Setting – Trust Mode- DSCP First	Switch(config)# interface fa1 Switch(config-if)# qos trust dscp-first The port trust is set DSCP first ok.
Display – Queue Scheduling	Switch# show qos queue-sched QoS queue scheduling scheme : Weighted Round Robin (Use an 8,4,2,1 weight)

QoS Setting (cont.)	
Display – Port Setting - Trust Mode	<pre>Switch# show qos trust QoS Port Trust Mode : Port  Trust Mode -----+-----       1  DSCP first       2   COS only       3   COS only       4   COS only       5   COS only       6   COS only       7   COS only       8   COS only</pre>
Display – Port Setting – CoS (Port Default Priority)	<pre>Switch# show qos port-cos Port Default Cos : Port  CoS -----+-----       1    7       2    0       3    0       4    0       5    0       6    0       7    0       8    0</pre>
CoS-Queue Mapping	
Format	<pre>Switch(config)# qos cos-map       PRIORITY  Assign an priority (7 highest) Switch(config)# qos cos-map 1       QUEUE    Assign an queue (0-3) <b>Format:</b> qos cos-map priority_value queue_value.</pre>
Map CoS 0 to Queue 1	<pre>Switch(config)# qos cos-map 0 1 The CoS to queue mapping is set ok.</pre>
Map CoS 1 to Queue 0	<pre>Switch(config)# qos cos-map 1 0 The CoS to queue mapping is set ok.</pre>
Map CoS 2 to Queue 0	<pre>Switch(config)# qos cos-map 2 0 The CoS to queue mapping is set ok.</pre>
Map CoS 3 to Queue 1	<pre>Switch(config)# qos cos-map 3 1 The CoS to queue mapping is set ok.</pre>
Map CoS 4 to Queue 2	<pre>Switch(config)# qos cos-map 4 2 The CoS to queue mapping is set ok.</pre>
Map CoS 5 to Queue 2	<pre>Switch(config)# qos cos-map 5 2 The CoS to queue mapping is set ok.</pre>
Map CoS 6 to Queue 3	<pre>Switch(config)# qos cos-map 6 3 The CoS to queue mapping is set ok.</pre>
Map CoS 7 to Queue 3	<pre>Switch(config)# qos cos-map 7 3 The CoS to queue mapping is set ok.</pre>

CoS-Queue Mapping (cont.)	
Display – CoS-Queue mapping	<pre>Switch# sh qos cos-map CoS to Queue Mapping : CoS  Queue ---- + -----   0     1   1     0   2     0   3     1   4     2   5     2   6     3   7     3</pre>
DSCP-Queue Mapping	
Format	<pre>Switch(config)# qos dscp-map     PRIORITY Assign an priority (63 highest) Switch(config)# qos dscp-map 0     QUEUE Assign an queue (0-3) <b>Format:</b> qos dscp-map priority_value queue_value.</pre>
Map DSCP 0 to Queue 1	<pre>Switch(config)# qos dscp-map 0 1 The TOS/DSCP to queue mapping is set ok.</pre>
Display – DSCO-Queue mapping	<pre>Switch# show qos dscp-map DSCP to Queue Mapping : (dscp = d1 d2)        d2  0 1 2 3 4 5 6 7 8 9 d1        -----+-----   0   1 1 1 1 1 1 1 1 0 0   1   0 0 0 0 0 0 0 0 0 0   2   0 0 0 0 1 1 1 1 1 1   3   1 1 2 2 2 2 2 2 2 2   4   2 2 2 2 2 2 2 2 3 3   5   3 3 3 3 3 3 3 3 3 3   6   3 3 3 3</pre>

## Multicast Filtering (CLI)

For multicast filtering, the ES8508 uses IGMP (Internet Group Management Protocol) Snooping technology. IGMP is an internet protocol that provides a way for internet device to report its multicast group membership to adjacent routers. Multicasting allows one computer on the internet to send data to a multitude of other computers that have identified themselves as being interested in receiving the originating computers data.

Multicasting is useful for such applications as updating the address books of mobile computer users in the field, sending out newsletters to a distribution list, and broadcasting streaming media to an audience that has tuned into the event by setting up multicast group membership.

In effect, IGMP Snooping manages multicast traffic by making use of switches, routers, and hosts that support IGMP. Enabling IGMP Snooping allows the ports to detect IGMP queries, report packets, and manage multicast traffic through the switch. IGMP has three fundamental types of messages, as shown in the following table.

Message	
Query	A message sent from the querier (an IGMP router or a switch) that asks for a response from each host that belongs to the multicast group.
Report	A message sent by a host to the querier to indicate that the host wants to be or is a member of a given group indicated in the report message.
Leave Group	A message sent by a host to the querier to indicate that the host has quit as a member of a specific multicast group.

You can enable **IGMP Snooping** and **IGMP Query** functions. This section illustrates the information of the IGMP Snooping function, including different multicast groups' VID and member ports, and IP multicast addresses that range from 224.0.0.0 to 239.255.255.255.

Optionally, you can use the web user interface for configuration, see [Multicast Filtering](#) on Page 103.

The following table provides detailed information about command lines for multicast filtering configuration.

IGMP Snooping	
IGMP Snooping - Global	Switch(config)# ip igmp snooping IGMP snooping is enabled globally. Specify on which vlans IGMP snooping enables
IGMP Snooping - VLAN	Switch(config)# ip igmp snooping vlan VLANLIST allowed vlan list all all existed vlan Switch(config)# ip igmp snooping vlan 1-2 IGMP snooping is enabled on VLAN 1-2.
Disable IGMP Snooping - Global	Switch(config)# no ip igmp snooping IGMP snooping is disabled globally ok.
Disable IGMP Snooping - VLAN	Switch(config)# no ip igmp snooping vlan 3 IGMP snooping is disabled on VLAN 3.

IGMP Snooping (Continued)	
Display – IGMP Snooping Setting	<pre>Switch# sh ip igmp interface vlan1 enabled: Yes version: IGMPv1 query-interval; 125s query-max-response-time: 10s  Switch# sh ip igmp snooping IGMP snooping is globally enabled Vlan1 is IGMP snooping enabled Vlan2 is IGMP snooping enabled Vlan3 is IGMP snooping disabled</pre>
Display – IGMP Table	<pre>Switch# sh ip igmp snooping multicast all VLAN   IP Address           Type    Ports ----   - 1      239.192.8.0         IGMP    fa6, 1      239.255.255.250    IGMP    fa6,</pre>
IGMP Query	
IGMP Query V1	<pre>Switch(config)# int vlan 1 Switch(config-if)# ip igmp v1</pre>
IGMP Query V2	<pre>Switch(config)# int vlan 1 Switch(config-if)# ip igmp</pre>
IGMP Query version	<pre>Switch(config-if)# ip igmp version 1 Switch(config-if)# ip igmp version 2</pre>
IGMP Query Interval	<pre>Switch(config)# int vlan 1 (Go to management VLAN) Switch(config-if)# ip igmp Switch(config-if)# ip igmp query-interval 60 (Change query interval to 60 seconds, default value is 125 seconds)</pre>
IGMP Query Max Response Time	<pre>Switch(config)# int vlan 1 (Go to management VLAN) Switch(config-if)# ip igmp Switch(config-if)# ip igmp query-max-response-time 15 (Change query max response time to 15 seconds, default value is 10 seconds)</pre>
Disable	<pre>Switch(config)# int vlan 1 Switch(config-if)# no ip igmp</pre>

<b>IGMP Query (Continued)</b>	
Display	<pre>Switch# sh ip igmp interface vlan1 enabled: Yes version: IGMPv2 query-interval: 125s query-max-response-time: 10s  Switch# show running-config ... ! interface vlan1 ip address 192.168.250.17/24 ip igmp no shutdown ! .....</pre>
<b>Force Filtering</b>	
Enable	<pre>Switch(config)# mac-address-table force filtering Filtering unknown multicast addresses ok!</pre>
Disable	<pre>Switch(config)# no mac-address-table force filtering Flooding unknown multicast addresses ok!</pre>



## SNMP (CLI)

Simple Network Management Protocol (SNMP) is a protocol used for exchanging management information between network devices. SNMP is a member of the TCP/IP protocol suite. The ES8508 supports SNMP v1 and v2c and V3.

An SNMP managed network consists of two main components: agents and a manager. An agent is a management software module that resides in a managed switch. An agent translates the local management information from the managed device into a SNMP compatible format. The manager is the console through the network.

Optionally, you can use the web user interface for configuration, see [SNMP](#) on Page 107.

The following table provides detailed information about command lines for SNMP configuration.

SNMP Community	
Read Only Community	Switch(config)# snmp-server community public ro community string add ok
Read Write Community	Switch(config)# snmp-server community private rw community string add ok
SNMP Trap	
Enable Trap	Switch(config)# snmp-server enable trap Set SNMP trap enable ok.
SNMP Trap Server IP without specific community name	Switch(config)# snmp-server host 192.168.250.33 SNMP trap host add OK.
SNMP Trap Server IP with version 1 and community	Switch(config)# snmp-server host 192.168.250.33 version 1 private SNMP trap host add OK. <b>Note:</b> Private is the community name, version 1 is the SNMP version.
SNMP Trap Server IP with version 2 and community	Switch(config)# snmp-server host 192.168.250.33 version 2 private SNMP trap host add OK.
Disable SNMP Trap	Switch(config)# no snmp-server enable trap Set SNMP trap disable ok.
Display	Switch# sh snmp-server trap SNMP trap: Enabled SNMP trap community: public  Switch# show running-config ..... snmp-server community public ro snmp-server community private rw snmp-server enable trap snmp-server host 192.168.250.33 version 2 admin snmp-server host 192.168.250.33 version 1 admin .....

## Security (CLI)

The ES8508 provides several security features for you to secure your connection.

Optionally, you can use the web user interface for configuration, see [Security](#) on Page 110.

This table provides information about the command lines for security configuration.

Port Security	
Add MAC	Switch(config)# mac-address-table static 00c0.4e3A.0101 vlan 1 interface fa1 mac-address-table unicast static set ok!
Port Security	Switch(config)# interface fa1 Switch(config-if)# switchport port-security Disables new MAC addresses learning and aging activities! <b>Rule:</b> Add the static MAC, VLAN and Port binding first, then enable the port security to stop new MAC learning.
Disable Port Security	Switch(config-if)# no switchport port-security Enable new MAC addresses learning and aging activities!
Display	Switch# show mac-address-table static Destination Address    Address Type    Vlan    Destination Port ----- 00c0.4e3A.0101        Static        1        fa1
IP Security	
IP Security	Switch(config)# ip security Set ip security enable ok. Switch(config)# ip security host 192.168.250.33 Add ip security host 192.168.250.33 ok.
Display	Switch# show ip security ip security is enabled ip security host: 192.168.250.33

802.1x	
enable	Switch(config)# dot1x system-auth-control Switch(config)#
disable	Switch(config)# no dot1x system-auth-control Switch(config)#
authentic-method	Switch(config)# dot1x authentic-method local    Use the local username database for authentication radius   Use the Remote Authentication Dial-In User Service (RADIUS) servers for authentication Switch(config)# dot1x authentic-method radius Switch(config)#
radius server-ip	Switch(config)# dot1x radius Switch(config)# dot1x radius server-ip 192.168.250.120 key 1234  RADIUS Server Port number NOT given. (default=1812) RADIUS Accounting Port number NOT given. (default=1813) RADIUS Server IP    : 192.168.250.120 RADIUS Server Key   : 1234 RADIUS Server Port  : 1812 RADIUS Accounting Port : 1813 Switch(config)#
radius server-ip	Switch(config)# dot1x radius Switch(config)# dot1x radius server-ip 192.168.250.120 key 1234  RADIUS Server Port number NOT given. (default=1812) RADIUS Accounting Port number NOT given. (default=1813) RADIUS Server IP    : 192.168.250.120 RADIUS Server Key   : 1234 RADIUS Server Port  : 1812 RADIUS Accounting Port : 1813 Switch(config)#
radius secondary-server-ip	Switch(config)# dot1x radius secondary-server-ip 192.168.250.250 key 5678  Port number NOT given. (default=1812) RADIUS Accounting Port number NOT given. (default=1813) Secondary RADIUS Server IP    : 192.168.250.250 Secondary RADIUS Server Key   : 5678 Secondary RADIUS Server Port  : 1812 Secondary RADIUS Accounting Port : 1813
User name/ password for authentication	Switch(config)# dot1x username chris passwd chris vlan 1

## Warnings (CLI)

The ES8508 provides several types of warning features for you to remotely monitor the status of the attached devices or changes in your network. The features include Fault Relay, System Log and SMTP Email Alert.

Optionally, you can use the web user interface for configuration, see [Warning](#) on Page 116.

This table provides detailed information about the command lines of the warning configuration.

Fault Relay Output	
Relay Output	<pre>Switch(config)# relay 1 di      DI State dry     dry output ping    ping failure port    port link failure power   power failure  <b>Note:</b> ring    super ring failure</pre>
DI State	<pre>Switch(config)# relay 1 di 1      DI number Switch(config)# relay 1 di 1 high   high is abnormal low    low is abnormal Switch(config)# relay 1 di 1 high</pre>
Dry Output	<pre>Switch(config)# relay 1 dry &lt;0-65535&gt; turn on period in second Switch(config)# relay 1 dry 5 &lt;0-65535&gt; turn off period in second Switch(config)# relay 1 dry 5 5</pre>
Event Selection	<pre>Switch(config)# warning-event coldstart      Switch cold start event warmstart      Switch warm start event linkdown       Switch link down event linkup         Switch link up event authentication Authentication failure event di             Switch di event fault-relay    Switch fault relay event loop-protect   Switch loop protection event power          Switch power failure event ring           Switch ring event time-sync      Switch time synchronize event</pre>
Example: Cold Start event	<pre>Switch(config)# warning-event coldstart Set cold start event enable ok.</pre>
Example: Link Up event	<pre>Switch(config)# warning-event linkup [IFNAME] Interface list, ex: fa1,fa3-5 Switch(config)# warning-event linkup fa1 Set fa5 link up event enable ok.</pre>

Fault Relay Output (cont.)	
Display	<pre>Switch# show warning-event Warning Event:   Cold Start: Enabled   Warm Start: Disabled   Authentication Failure: Disabled   Link Down: fa4-5   Link Up: fa4-5   Power Failure:   Ring: Disabled   Fault Relay: Disabled   Time synchronize Failure: Disabled   DI: Disabled</pre>
Syslog Configuration	
Local Mode	Switch(config)# log syslog local
Server Mode	Switch(config)# log syslog remote 192.168.250.33
Both	Switch(config)# log syslog local Switch(config)# log syslog remote 192.168.250.33
Disable	Switch(config)# no log syslog local
SMTP Configuration	
SMTP Enable	Switch(config)# smtp-server enable email-alert SMTP Email Alert set enable ok.
Sender mail	Switch(config)# smtp-server server 192.168.250.100 ACCOUNT SMTP server mail account, ex: admin@control.com Switch(config)# smtp-server server 192.168.250.100 admin@control.com SMTP Email Alert set Server: 192.168.250.100, Account: admin@control.com ok.
Receiver mail	Switch(config)# smtp-server receipt 1 abc@control.com SMTP Email Alert set receipt 1: abc@control.com ok.
Authentication with user name and password	Switch(config)# smtp-server authentication username admin password admin SMTP Email Alert set authentication Username: admin, Password: admin  <b>Note:</b> You can assign string to user name and password.
Disable SMTP	Switch(config)# no smtp-server enable email-alert SMTP Email Alert set disable ok.
Disable Authentication	Switch(config)# no smtp-server authentication SMTP Email Alert set Authentication disable ok.

SMTP Configuration	
Display	Switch# sh smtp-server SMTP Email Alert is Enabled Server: 192.168.250.100, Account: admin@control.com Authentication: Enabled Username: admin, Password: admin SMTP Email Alert Receipt: Receipt 1: abc@control.com Receipt 2: Receipt 3: Receipt 4:

## Monitor and Diag (CLI)

The ES8508 provides several types of features for you to monitor the status of the switch or diagnostic for you to check the problem when encountering problems related to the switch. The features include MAC Address Table, Port Statistics, Port Mirror, Event Log, and Ping.

Optionally, you can use the web user interface for configuration, see [Monitor and Diag](#) on Page 121.

This table provides detailed information about command lines of the Monitor and Diag configuration.

MAC Address Table	
Aging Time	<pre>Switch(config)# mac-address-table aging-time 350 mac-address-table aging-time set ok!</pre> <p><b>Note:</b> The default aging timeout value is 300.</p>
Add Static Unicast MAC address	<pre>Switch(config)# mac-address-table static 00c0.4e3A.0101 vlan 1 interface fastethernet5 mac-address-table ucast static set ok!</pre> <p><b>Rule:</b> mac-address-table static MAC_address VLAN VID interface interface_name</p>
Add Multicast MAC address	<pre>Switch(config)# mac-address-table multicast 00c0.4e3A.0101 vlan 1 interface fa3-4 Adds an entry in the multicast table ok!</pre> <p><b>Rule:</b> mac-address-table multicast MAC_address VLAN VID interface_list interface_name/range</p>
Show MAC Address Table – All types	<pre>Switch# show mac-address-table  ***** UNICAST MAC ADDRESS ***** Destination Address  Address Type      Vlan    Destination Port ----- 00c0.4e3A.ca3b      Dynamic          1       fa1 00c0.4e3A.0386      Dynamic          1       fa2 00c0.4e3A.0101      Static           1       fa3 00c0.4e3A.0102      Static           1       fa3 00c0.4e3A.0100      Management       1 ***** MULTICAST MAC ADDRESS ***** Vlan   Mac Address      COS    Status   Ports -----   1    00c0.4e3A.0800    0     fa6   1    00c0.4e3A.ffffa  0     fa4,fa6</pre>
Show MAC Address Table – Dynamic Learnt MAC addresses	<pre>Switch# show mac-address-table dynamic Destination Address  Address Type      Vlan    Destination Port ----- 00c0.4e3A.ca3b      Dynamic          1       fa4 00c0.4e3A.0386      Dynamic          1       fa6</pre>
Show MAC Address Table – Multicast MAC addresses	<pre>Switch# show mac-address-table multicast Vlan   Mac Address      COS    Status   Ports -----   1    00c0.4e3A.0800    0     fa5-6   1    00c0.4e3A.ffffa  0     fa3,fa5-6</pre>

MAC Address Table (continued)	
Show MAC Address Table – Static MAC addresses	<pre>Switch# show mac-address-table static Destination Address  Address Type      Vlan      Destination Port ----- 00c0.4e3A.0101      Static            1         fa4 00c0.4e3A.0102      Static            1         fa5</pre>
Show Aging timeout time	<pre>Switch# show mac-address-table aging-time the mac-address-table aging-time is 300 sec.</pre>
Port Statistics	
Port Statistics	<pre>Switch# show rmon statistics fa4 (select interface) Interface fastethernet4 is enable connected, which has   Inbound:     Good Octets: 178792, Bad Octets: 0     Unicast: 598, Broadcast: 1764, Multicast: 160     Pause: 0, Undersize: 0, Fragments: 0     Oversize: 0, Jabbers: 0, Discards: 0     Filtered: 0, RxError: 0, FCSError: 0   Outbound:     Good Octets: 330500     Unicast: 602, Broadcast: 1, Multicast: 2261     Pause: 0, Deferred: 0, Collisions: 0     SingleCollision: 0, MultipleCollision: 0     ExcessiveCollision: 0, LateCollision: 0     Filtered: 0, FCSError: 0 Number of frames received and transmitted with a length of:   64: 2388, 65to127: 142, 128to255: 11   256to511: 64, 512to1023: 10, 1024toMaxSize: 42</pre>
Enable Port Mirror	<pre>Switch(config)# mirror en Mirror set enable ok.</pre>
Disable Port Mirror	<pre>Switch(config)# mirror disable Mirror set disable ok.</pre>
Select Source Port	<pre>Switch(config)# mirror source fal-2   both Received and transmitted traffic   rx   Received traffic   tx   Transmitted traffic Switch(config)# mirror source fal-2 both Mirror source fal-2 both set ok.  <b>Note:</b> Select source port list and TX/RX/Both mode.</pre>
Select Destination Port	<pre>Switch(config)# mirror destination fa6 Mirror destination fa6 set ok</pre>



Port Mirroring (continued)	
Display	<pre>Switch# show mirror Mirror Status : Enabled Ingress Monitor Destination Port : fa6 Egress Monitor Destination Port : fa6 Ingress Source Ports :fa1,fa2, Egress Source Ports :fa1,fa2,</pre>
Event Log	
Display	<pre>Switch# show event-log &lt;1&gt;Jan  1 02:50:47 snmpd[101]: Event: Link 4 Down. &lt;2&gt;Jan  1 02:50:50 snmpd[101]: Event: Link 5 Up. &lt;3&gt;Jan  1 02:50:51 snmpd[101]: Event: Link 5 Down. &lt;4&gt;Jan  1 02:50:53 snmpd[101]: Event: Link 4 Up.</pre>
Topology Discovery (LLDP)	
Enable LLDP	<pre>Switch(config)# lldp   holdtime Specify the holdtime of LLDP in seconds   run       Enable LLDP   timer     Set the transmission frequency of LLDP in seconds Switch(config)# lldp run LLDP is enabled!</pre>
Change LLDP timer	<pre>Switch(config)# lldp holdtime &lt;10-255&gt; Valid range is 10~255 Switch(config)# lldp timer &lt;5-254&gt; Valid range is 5~254</pre>
Ping	
Ping IP	<pre>Switch# ping 192.168.11.14 PING 192.168.11.14 (192.168.11.14): 56 data bytes 64 bytes from 192.168.11.14: icmp_seq=0 ttl=128 time=0.0 ms 64 bytes from 192.168.11.14: icmp_seq=1 ttl=128 time=0.0 ms 64 bytes from 192.168.11.14: icmp_seq=2 ttl=128 time=0.0 ms 64 bytes from 192.168.11.14: icmp_seq=3 ttl=128 time=0.0 ms 64 bytes from 192.168.11.14: icmp_seq=4 ttl=128 time=0.0 ms --- 192.168.11.14 ping statistics --- packets transmitted, 5 packets received, 0% packet loss round-trip min/avg/max = 1.3/1.3/1.4 ms</pre>

## Saving to Flash (CLI)

---

---

**Save Configuration** allows you to save any configuration you just made to the flash. Powering off the switch without saving the configuration causes loss of the new settings.

Saving to Flash	
Save to Flash	SWITCH# write Building Configuration... [OK]  Switch# copy running-config startup-config Building Configuration... [OK]

## Logging Out (CLI)

---

---

The CLI connection logs out of configure terminal mode, if you do not input any command after 30 seconds.

Logging Out	
Logout	SWITCH> exit  SWITCH# exit

## Service (CLI)

---

---

The service command provides the ability to disable HTTP and Telnet.

**Note:** *There is not a web user interface page for the service command.*

Service	
Disable HTTP	Switch(config)# service http disable Switch(config)#
Enable HTTP	Switch(config)# service http enable Switch(config)#
Disable telnet	Switch(config)# service telnet disable Switch(config)#
Enable telnet	Switch(config)# service telnet enable Switch(config)#

# Complete CLI List

This section provides the complete listing of RocketLinx ES8508 Series commands with the supporting options:

- [User EXEC Mode](#)
- [Privileged EXEC Mode](#) on Page 188
- [Global Configuration Mode](#) on Page 193
- [Port Interface Configuration Mode](#) on Page 198
- [VLAN Interface Configuration Mode](#) on Page 200

## User EXEC Mode

---

For information about accessing *User EXEC* mode, see [User EXEC Mode](#) on Page 187.

```
Switch> list
enable
exit
list
ping WORD
ping ipv6 WORD
quit
show arp
show gvrp statistics [IFNAME]
show ip forwarding
show ip route
show ip route A.B.C.D
show ip route A.B.C.D/M
show ip route supernets-only
show version
telnet WORD
telnet WORD PORT
traceroute WORD
traceroute ipv6 WORD
```

## Privileged EXEC Mode

---

---

For information about accessing *Privileged EXEC* mode, see [Privileged EXEC Mode](#) on Page 188.

```
Switch# list
archive download-boot /overwrite tftp IPADDRESS IMAGE
archive download-sw /overwrite tftp IPADDRESS IMAGE
clear event-log
clear gvrp statistics [IFNAME]
clear lacp counters
clear mac-address-table dynamic
clear mac-address-table dynamic address MACADDR
clear mac-address-table dynamic interface IFNAME
clear mac-address-table dynamic vlan VLANID
clear redundant-ring statistics [0-31]
clear rmon statistics [IFNAME]
clear spanning-tree counters
clear spanning-tree counters interafce IFNAME
clear spanning-tree detected-protocols
clear spanning-tree detected-protocols interface IFNAME
clock set TIME MONTH DAY YEAR
configure terminal
copy running-config startup-config
copy startup-config tftp: URL
copy tftp: URL (ssh-dss|ssh-rsa)
copy tftp: URL ssl-cert
copy tftp: URL startup-config
debug dot1x all
debug dot1x errors
debug dot1x events
debug dot1x packets
debug dot1x registry
debug dot1x state-machine
debug gmrp
debug gvrp (all|rcv|tx|gvrp_event|vlan_event)
debug ip dhcp (all|event)
debug ip dhcp snooping
debug ip igmp
debug ip igmp snooping (all|group|management|router|timer)
debug l2 mac (all|trace|debug)
debug lacp (all|event|fsm|misc|packet)
debug lldp
debug proto pdu
debug ptpd all
debug rate-limit
debug redundant-ring (pdu|trace|debug|rapid-dual-homing|rstp|multi-ring|all) <0-31>
debug snmp
debug spanning-tree (all|bpdu|config|events|general|root|sync|tc)
debug trunk
debug vlan (all|trace|debug)
disable
dot1x initialize interface IFNAME
dot1x reauthenticate interface IFNAME
```

**Privileged EXEC Mode (continued)**

```
end
exit
hardware sensor (enable|disable)
list
no debug dot1x all
no debug dot1x errors
no debug dot1x events
no debug dot1x packets
no debug dot1x registry
no debug dot1x state-machine
no debug gmrp
no debug gvrp (all|rcv|tx|gvrp_event|vlan_event)
no debug ip dhcp (all|event)
no debug ip dhcp snooping
no debug ip igmp
no debug ip igmp snooping (all|group|management|router|timer)
no debug l2 mac (all|trace|debug)
no debug lacp (all|event|fsm|misc|packet)
no debug lldp
no debug proto
no debug ptpd
no debug rate-limit
no debug redundant-ring <0-31>
no debug snmp
no debug spanning-tree (all|bpdu|config|events|general|root|sync|tc)
no debug trunk
no debug vlan (all|trace|debug)
no pager
pager
ping WORD
ping ipv6 WORD
quit
reboot
reload default-config file
reload default-ssh file
reload default-ssl file
show acceptable frame type [IFNAME]
show administrator
show arp
show clock
show clock summer-time
show clock timezone
show debugging dot1x
show debugging gvrp
show debugging ip dhcp
show debugging ip igmp
show debugging ip igmp snooping
show debugging lacp
show debugging snmp
show debugging spanning-tree
show deny host mac-address
show dot1q-tunnel
```

***Privileged EXEC Mode (continued)***

```
show dot1x
show dot1x all
show dot1x authentic-method
show dot1x interface IFNAME
show dot1x radius
show dot1x statistics interface IFNAME
show dot1x username
show ethertype
show event-log
show garp timer [IFNAME]
show gmrp
show gvrp configuration [IFNAME]
show gvrp portstate IFNAME VID
show hardware led
show hardware mac
show ingress filtering [IFNAME]
show interface [IFNAME]
show ip dhcp relay
show ip dhcp server statistics
show ip forwarding
show ip igmp
show ip igmp group
show ip igmp interface IFNAME
show ip igmp query-interval
show ip igmp query-max-response-time
show ip igmp snooping
show ip igmp snooping multicast (dynamic|user|all) [VLANLIST]
show ip igmp snooping multicast count
show ip igmp snooping vlan (VLANLIST|all)
show ip igmp timers
show ip igmp version
show ip route
show ip route A.B.C.D
show ip route A.B.C.D/M
show ip route supernets-only
show ip security
show ipv6 neighbour
show ipv6 route
show l2_interface [IFNAME]
show lacp counters [GROUPID]
show lacp group [1-8]
show lacp internal [1-8]
show lacp neighbor [1-8]
show lacp port-setting [IFNAME]
show lacp system-id
show lacp system-priority
show lldp
show lldp neighbors
show lldp statistics
show loop-protect
show mac-address-table
show mac-address-table aging-time
```

**Privileged EXEC Mode (continued)**

```
show mac-address-table dynamic
show mac-address-table dynamic address MACADDR
show mac-address-table dynamic interface IFNAME
show mac-address-table dynamic vlan VLANID
show mac-address-table multicast
show mac-address-table multicast MACADDR vlan VLANID
show mac-address-table multicast filtering
show mac-address-table static
show mac-address-table static address MACADDR
show mac-address-table static interface IFNAME
show mac-address-table static vlan VLANID
show mirror
show modbus
show nameserver
show netvision password
show ntp associations
show ptpd
show qos cos-map
show qos dscp-map
show qos port-cos
show qos queue-sched
show qos trust
show rate-limit egress [IFNAME]
show rate-limit ingress [IFNAME]
show redundant-ring [0-31]
show relay 1
show relay 1 status
show rmon statistics [IFNAME]
show running-config
show service
show smtp-server
show smtp-server authentication
show smtp-server email-alert
show smtp-server receipt
show smtp-server server
show snmp-server community
show snmp-server contact
show snmp-server host
show snmp-server location
show snmp-server name
show snmp-server trap
show snmp-server user
show spanning-tree active
show spanning-tree interface IFNAME
show spanning-tree mst
show spanning-tree mst <0-15>
show spanning-tree mst <0-15> interface IFNAME
show spanning-tree mst configuration
show spanning-tree mst interface IFNAME
show spanning-tree mst root
show spanning-tree summary
show startup-config
```

***Privileged EXEC Mode (continued)***

```
show system status
show trunk group [1-8]
show version
show vlan
show vlan (static|dynamic) [VLANID]
show vlan VLANID
show vlan management
show vlan name VLANNAME
show vlan private-vlan
show vlan private-vlan port-list
show vlan private-vlan type
show warning-event
telnet WORD
telnet WORD PORT
terminal length <0-512>
terminal no length
traceroute WORD
traceroute ipv6 WORD
write
write file
write memory
write terminal
```



## Global Configuration Mode

---

For information about accessing *Global Configuration mode*, see [Global Configuration Mode](#) on Page 193.

```
Switch(config)# list
administrator NAME PASSWORD
arp A.B.C.D H.H.H
clock set TIME MONTH DAY YEAR
clock summer-time (enable|disable)
clock summer-time <1-5> <0-6> <1-12> START_TIME <1-5> <0-6> <1-12> END_TIME
clock timezone
  (01|02|03|04|05|06|07|08|09|10|11|12|13|14|15|16|17|18|19|20|21|22|23|24|25|26|27
  |28|29|30|31|32|33|34|35|36|37|38|39|40|41|42|43|44|45|46|47|48|49|50|51|52|53|54
  |55|56|57|58|59|60|61|62|63|64|65|66|67|68|69|70|71|72|73|74)
default dot1x system-auth-control
default gvrp configuration
default ip igmp snooping
dot1x authentic-method (radius|local)
dot1x radius secondary-server-ip A.B.C.D key RADIUS_KEY [PORT] [PORT]
dot1x radius server-ip A.B.C.D key RADIUS_KEY [PORT] [PORT]
dot1x system-auth-control
dot1x username WORD passwd WORD vlan <1-4094>
end
ethertype [0x0800-0xFFFF]
exit
gmrp mode (enable|disable)
gmrp mode (enable|disable) IFNAME
gvrp mode (enable|disable)
gvrp mode (enable|disable) IFNAME
gvrp registration (normal|fixed|forbidden) IFNAME
hostname .DWORD
interface IFNAME
interface vlan VLAN-ID
ip forwarding
ip igmp snooping
ip igmp snooping immediate-leave
ip igmp snooping immediate-leave vlan (VLANLIST|all)
ip igmp snooping last-member-query-interval TIMEVALUE
ip igmp snooping last-member-query-interval TIMEVALUE vlan (VLANLIST|all)
ip igmp snooping source-only-learning
ip igmp snooping vlan (VLANLIST|all)
ip route A.B.C.D A.B.C.D (A.B.C.D|INTERFACE)
ip route A.B.C.D A.B.C.D (A.B.C.D|INTERFACE) <1-255>
ip route A.B.C.D/M (A.B.C.D|INTERFACE)
ip route A.B.C.D/M (A.B.C.D|INTERFACE) <1-255>
ip security
ip security host A.B.C.D
ipv6 route X:X::X:X/M (X:X::X:X|INTERFACE)
lacp group <1-8> IFLIST
lacp system-priority <1-65535>
list
lldp holdtime <10-255>
lldp run
lldp timer <5-254>
```

**Global Configuration Mode (continued)**

```
log file FILENAME
log stdout
log syslog local
log syslog remote A.B.C.D
loop-protect (enable|disable) IFLIST
loop-protect (enable|disable) all
loop-protect transmit-interval <1-10>
mac-address-table aging-time TIMEVALUE
mac-address-table multicast MACADDR vlan VLANID interface IFLIST
mac-address-table multicast filtering
mac-address-table static MACADDR vlan VLANID interface IFNAME
mirror (enable|disable)
mirror destination IFNAME (rx|tx|both)
mirror source IFLIST (rx|tx|both)
modbus (enable|disable)
modbus idle-timeout <200-10000>
modbus master <1-20>
modbus port <1-65535>
nameserver A.B.C.D
netvision password PASS
no administrator
no arp A.B.C.D
no clock set
no clock summer-time
no clock timezone
no dot1x authentic-method
no dot1x radius secondary-server-ip
no dot1x system-auth-control
no dot1x username WORD
no hostname [HOSTNAME]
no interface IFNAME
no interface vlan VLAN-ID
no ip forwarding
no ip igmp snooping
no ip igmp snooping immediate-leave
no ip igmp snooping immediate-leave vlan (VLANLIST|all)
no ip igmp snooping last-member-query-interval
no ip igmp snooping last-member-query-interval vlan (VLANLIST|all)
no ip igmp snooping source-only-learning
no ip igmp snooping vlan (VLANLIST|all)
no ip route A.B.C.D A.B.C.D (A.B.C.D|INTERFACE)
no ip route A.B.C.D A.B.C.D (A.B.C.D|INTERFACE) <1-255>
no ip route A.B.C.D/M (A.B.C.D|INTERFACE)
no ip route A.B.C.D/M (A.B.C.D|INTERFACE) <1-255>
no ip security
no ip security host A.B.C.D
no ipv6 route X:X::X:X/M (X:X::X:X|INTERFACE)
no lacp group <1-8>
no lacp system-priority
no lldp run
no log file
no log stdout
```

**Global Configuration Mode (continued)**

```
no log syslog local
no log syslog remote
no loop-protect transmit-interval
no mac-address-table aging-time
no mac-address-table multicast MACADDR vlan VLANID
no mac-address-table multicast MACADDR vlan VLANID interface IFLIST
no mac-address-table multicast filtering
no mac-address-table static MACADDR vlan VLANID interface IFNAME
no mirror destination (rx|tx|both)
no mirror source IFLIST (rx|tx|both)
no nameserver A.B.C.D
no netvision password
no ntp peer (primary|secondary)
no ptpd run
no qos cos-map
no qos dscp-map
no qos queue-sched
no relay 1
no relay 1 di
no relay1 dry
no relay 1 ping
no relay 1 ping reset
no relay 1 port
no relay 1 power
no relay 1 ring
no smtp-server authentication
no smtp-server authentication username password
no smtp-server enable email-alert
no smtp-server receipt <1-4>
no smtp-server server
no snmp-server community WORD (ro|rw)
no snmp-server community trap
no snmp-server contact
no snmp-server enable trap
no snmp-server host A.B.C.D [VERSION]
no snmp-server location
no snmp-server name
no snmp-server user WORD v3
no spanning-tree bridge-times
no spanning-tree forward-time
no spanning-tree hello-time
no spanning-tree max-age
no spanning-tree mst MSTMAP priority
no spanning-tree mst configuration
no spanning-tree mst forward-time
no spanning-tree mst hello-time
no spanning-tree mst max-age
no spanning-tree mst max-hops
no spanning-tree priority
no spanning-tree transmission-limit
no trunk group <1-8>
no vlan [VLANID]
```

**Global Configuration Mode (continued)**

```
no warning-event (coldstart|warmstart)
no warning-event (linkdown|linkup) [IFLIST]
no warning-event authentication
no warning-event di 1
no warning-event fault-relay
no warning-event loop-protect
no warning-event power <1-2>
no warning-event ring
no warning-event time-sync
no write-config (daemon|integrated)
ntp peer (enable|disable)
ntp peer (primary|secondary) IPADDRESS
ptpd run
ptpd run preferred-clock
ptpd run slave
qos cos-map PRIORITY QUEUE
qos dscp-map PRIORITY QUEUE
qos queue-sched (wrr|sp)
redundant-ring <0-31>
relay 1 di 1 (high|low)
relay 1 dry <0-65535> <0-65535>
relay 1 ping WORD
relay 1 ping WORD reset <1-65535> <0-65535>
relay 1 port PORTLIST
relay 1 power <1-2>
relay 1 power any
relay 1 ring
router dhcp
service http (enable|disable)
service telnet (enable|disable)
smtp-server authentication
smtp-server authentication username WORD password WORD
smtp-server enable email-alert
smtp-server receipt <1-4> EMAIL
smtp-server server A.B.C.D ACCOUNT
snmp-server community WORD (ro|rw)
snmp-server community trap WORD
snmp-server contact .DWORD
snmp-server enable trap
snmp-server host A.B.C.D
snmp-server host A.B.C.D version (1|2) [COMMUNITY]
snmp-server location .DWORD
snmp-server name .DWORD
snmp-server user WORD v3 auth (md5|sha) WORD
snmp-server user WORD v3 noauth
snmp-server user WORD v3 priv (md5|sha) WORD des WORD
spanning-tree (enable|disable)
spanning-tree bridge-times <4-30> <6-40> <1-10>
spanning-tree forward-time <4-30>
spanning-tree hello-time <1-10>
spanning-tree max-age <6-40>
spanning-tree mode (stp|rst)
```

**Global Configuration Mode (continued)**

```
spanning-tree mode mst
spanning-tree mst MSTMAP priority <0-61440>
spanning-tree mst configuration
spanning-tree mst forward-time <4-30>
spanning-tree mst hello-time <1-10>
spanning-tree mst max-age <6-40>
spanning-tree mst max-hops <1-40>
spanning-tree mst sync vlan <1-4094>
spanning-tree pathcost method (long|short)
spanning-tree priority <0-61440>
spanning-tree transmission-limit <1-10>
trunk group <1-8> IFLIST
vlan <1-4094>
vlan learning (independent|shared)
warning-event (coldstart|warmstart)
warning-event (linkdown|linkup) [IFLIST]
warning-event authentication
warning-event di 1
warning-event fault-relay
warning-event loop-protect
warning-event power <1-2>
warning-event ring
warning-event time-sync
write-config (daemon|integrated)
```

## Port Interface Configuration Mode

---

---

For information about accessing *Port Interface Configuration* mode, see [Port Interface Configuration Mode](#) on Page 198.

```
Switch(config)# interface 1
Switch(config-if)# list
  acceptable frame type (all|vlantaggedonly)
  auto-negotiation
  description .LINE
  dot1x admin-control-direction (both|in)
  dot1x default
  dot1x guest-vlan <1-4094>
  dot1x host-mode (single-host|multi-host)
  dot1x max-req <1-10>
  dot1x port-control (auto|force-authorized|force-unauthorized)
  dot1x reauthentication
  dot1x timeout (reauth-period|quiet-period|tx-period|supp-timeout|server-timeout)
    TIMEVALUE
  duplex (half|full)
  end
  exit
  flowcontrol (off|on)
  garp join-timer <10-10000>
  garp leave-timer <30-30000>
  garp leaveall-timer <150-150000>
  ingress filtering (enable|disable)
  lacp port-priority <1-65535>
  lacp timeout (long|short)
  list
  loopback
  mdix auto
  mtu <64-9216>
  no description
  no dot1x admin-control-direction
  no dot1x guest-vlan
  no dot1x host-mode
  no dot1x max-req
  no dot1x port-control
  no dot1x reauthentication
  no dot1x timeout (reauth-period|quiet-period|tx-period|supp-timeout|server-
    timeout)
  no duplex
  no garp join-timer
  no garp leave-timer
  no garp leaveall-timer
  no lacp port-priority
  no lacp timeout
  no loopback
  no mdix auto
  no mtu
  no qos cos
  no qos trust
  no rate-limit egress bandwidth
  no rate-limit ingress bandwidth
```

**Port Interface Mode (continued)**

```
no rate-limit ingress mode
no shutdown
no spanning-tree bpdudfilter
no spanning-tree bpduguard
no spanning-tree cost
no spanning-tree edge-port
no spanning-tree link-type
no spanning-tree mst MSTMAP cost
no spanning-tree mst MSTMAP port-priority
no spanning-tree port-priority
no spanning-tree stp-state
no speed
no switchport access vlan VLANID
no switchport block
no switchport dot1q-tunnel mode (access|uplink)
no switchport mode private-vlan host
no switchport mode private-vlan promiscuous
no switchport port-security
no switchport private-vlan host-association
no switchport trunk native vlan
qos cos DEFAULT-COS
qos trust (cos|dscp|cos-first|dscp-first)
quit
rate-limit egress bandwidth <0-100>
rate-limit ingress bandwidth <0-100>
rate-limit ingress mode (all|flooded-unicast|multicast|broadcast)
shutdown
spanning-tree bpdudfilter
spanning-tree bpduguard
spanning-tree cost <1-200000000>
spanning-tree edge-port
spanning-tree link-type (auto|point-to-point|shared)
spanning-tree mst MSTMAP cost <1-200000000>
spanning-tree mst MSTMAP port-priority <0-240>
spanning-tree port-priority <0-240>
spanning-tree stp-state (enable|disable)
speed (10|100)
switchport access vlan VLANID
switchport access vlan add VLANLIST
switchport access vlan remove VLANLIST
switchport block (multicast|unicast|both)
switchport dot1q-tunnel mode (access|uplink)
switchport dot1q-tunnel mode uplink add-pvid
switchport mode private-vlan host
switchport mode private-vlan promiscuous
switchport port-security
switchport private-vlan host-association <2-4094> <2-4094>
switchport private-vlan mapping <2-4094> add VLANLIST
switchport private-vlan mapping <2-4094> remove VLANLIST
switchport trunk allowed vlan add VLANLIST
switchport trunk allowed vlan remove VLANLIST
switchport trunk native vlan VLANID
```

## VLAN Interface Configuration Mode

---

---

For information about accessing VLAN Interface Configuration mode, see [VLAN Interface Configuration Mode](#) on Page 200.

```
Switch(config-if)# interface vlan1
Switch(config-if)# list
  description .LINE
  end
  exit
  ip address A.B.C.D/M
  ip dhcp client
  ip dhcp client renew
  ip igmp
  ip igmp last-member-query-count CNT
  ip igmp last-member-query-interval SECONDS
  ip igmp query-interval SECONDS
  ip igmp query-max-response-time SECONDS
  ip igmp robustness-variable CNT
  ip igmp version (1|2)
  ipv6 address X:X::X:X/M
  list
  no description
  no ip address A.B.C.D/M
  no ip dhcp client
  no ip igmp
  no ipv6 address X:X::X:X/M
  no shutdown
  quit
  shutdown
```



# ModBus TCP /IP Support

This section provides the following information:

- [Modbus TCP/IP Function Codes](#) on Page 202
- [Error Checking](#) on Page 202
- [Exception Response](#) on Page 202
- [Modbus TCP Register Table](#) on Page 203
- [CLI Commands for Modbus TCP/IP](#) on Page 210

## Overview

---

The ES8508 supports Modbus TCP/IP communications through the CLI, which does not support Modbus ASCII or Modbus RTU. This functionality is not available on a web user interface page.

Modbus TCP/IP is commonly used to communicate over TCP/IP networks, connecting over Port 502. Modbus TCP/IP is used in industrial automatic communications systems and has become a standard protocol for industrial communications to transfer data to analog I/O devices or PLC systems.

Modbus TCP/IP defines a simple protocol data unit independent of the underlying data link layer. The Modbus TCP/IP packet includes three parts:

- MBAP header is used in the TCP/IP header to identify the Modbus application data unit. The MBAP header also includes a unit identifier to recognize and communicate between multiple independent Modbus end units.
- Function code
- Data payload

Modbus devices communicate using a master (client) /slave (server) architecture, only one device can initiate a transaction and the others respond to the master/client. The other devices (slave/server) respond by supplying the requested data to the master/client, or by taking the action requested in the query. The slave/server can be any peripheral device that processes information and sends the output data to the master using Modbus TCP/IP protocol.

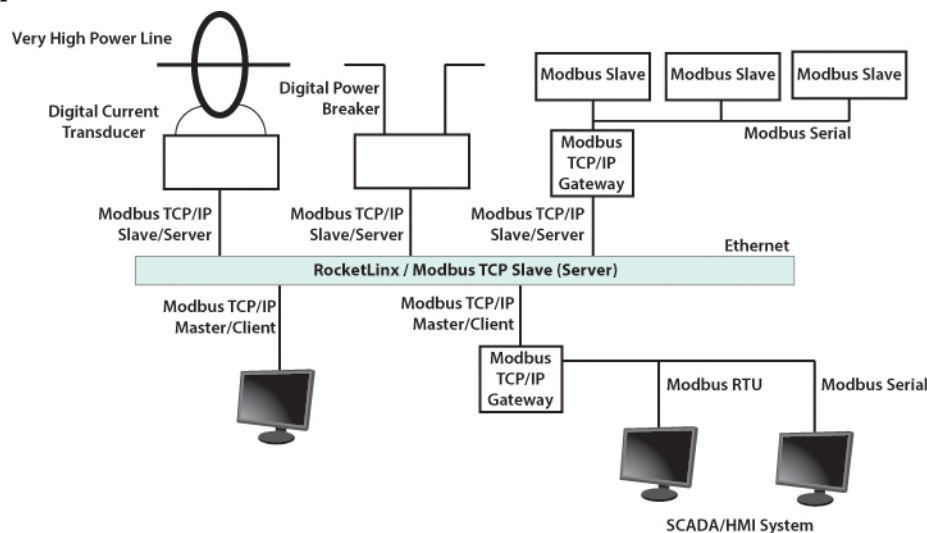

The ES8508 operates as slave/server device, while a typical master/client device is a host computer running appropriate application software, for example, a SCADA / HMI system. The ES8508 can be polled through

Ethernet, thus the Modbus TCP/IP master can read or write to the Modbus registers provided by the Modbus TCP/IP.

The ES8508 firmware provides Modbus TCP/IP registers that map to the ES8508 operating system information which, includes the description, IP address, power status, interface status, interface information and inbound/outbound packet statistics. With the register support, you can read the information through the Modbus TCP/IP based progress/ display/ monitor applications and monitor the status of the switch easily.

## Modbus TCP/IP Function Codes

---

Modbus TCP/IP devices use a subset of the standard Modbus TCP/IP function codes to access device-dependent information. Modbus TCP/IP function codes are defined in the following table.

Function Code	Name	Usage
01	Read Coils	Reads the state of a digital output.
02	Read Input Status	Reads the state of a digital input.
03	Read Holding Register	Reads the holding register in 16-bit register format.
04 (see note)	Read Input Registers	Reads data in 16-bit register format.
05	Write Coil	Writes data to force a digital output ON/OFF.
06	Write Single Register	Writes data in 16-bit register format.
15	Force Multiple Coils	Writes data to force multiple consecutive coils.
<p><b>Note:</b> The ES8508 supports Function Code 04, the Read Input Registers. With this support, the remote SCADA or other Modbus TCP/IP applications can poll the information of the device and monitor the major status of the ES8508.</p>		

## Error Checking

---

The utilization of the error checking helps eliminate errors caused by noise in the communications link. In Modbus TCP/IP mode, messages include an error-checking field that is based on a Cyclical Redundancy Check (CRC) method. The CRC field checks the contents of the entire message. It is applied regardless of any parity check method used for the individual BYTE characters of the message. The CRC value is calculated by the transmitting device, which appends the CRC to the message. The receiving device recalculates a CRC during receipt of the message, and compares the calculated value to the actual value it received in the CRC field.

## Exception Response

---

If an error occurs, the slave sends an exception response message to master consisting of the slave address, function code, exception response code and error check field. In an exception response, the slave sets the high-order bit (MSB) of the response function code to one.

Code	Name	Descriptions
01	Illegal Function	The message function received is not an allowable action.
02	Illegal Data Address	The address referenced in the data field is not valid.
03	Illegal Data Value	The value referenced at the addressed device location is not within range.
04	Slave Device Failure	An unrecoverable error occurred while the slave was attempting to perform the requested action.

Code	Name	Descriptions
05	Acknowledge	The slave has accepted the request and processing it, but a long duration of time is required to do so.
06	Slave Device Busy	The slave is engaged in processing a long-duration program command.
07	Negative Acknowledge	The slave cannot perform the program function received in the query.
08	Memory Parity Error	The slave attempted to read extended memory, but detected a parity error in the memory.

## Modbus TCP Register Table

The latest firmware provides the initial release of the Modbus TCP/IP client service support for factory automation applications. You can implement the modbus command using the command line interface in console and Telnet modes, which allows you to modify some parameters such as, idle time, number of Modbus masters, and the Modbus service port.

**Note:** The Modbus TCP client returns 0xFFFF to a Modbus master when pulling a reserved address.

Word Address	Data Type	Description
<b>System Information</b>		
0x0000	16 words	Vender Name = "Comtrol" Word 0 Hi byte = 'C' Word 0 Lo byte = 'o' Word 1 Hi byte = 'm' Word 1 Lo byte = 't' Word 2 Hi byte = 'r' Word 2 Lo byte = 'o' Word 3 Hi byte = 'l' Word 3 Lo byte = '\0' (other words = 0)
0x0010	16 words	Product Name = "ES8508"  Word 0 Hi byte = 'E' Word 0 Lo byte = 'S' Word 1 Hi byte = '8' Word 1 Lo byte = '5' Word 2 Hi byte = '0' Word 2 Lo byte = '8' Word 3 Hi byte = '\0' (other words = 0)

Word Address	Data Type	Description
0x0010	16 words	Product Name = "ES8508F-M" Word 0 Hi byte = 'E' Word 0 Lo byte = 'S' Word 1 Hi byte = '8' Word 1 Lo byte = '5' Word 2 Hi byte = '0' Word 2 Lo byte = '8' Word 3 Hi byte = 'F' Word 3 Lo byte = '-' Word 4 Hi byte = 'M' Word 4 Lo byte = '\0' (other words = 0)
0x0010	16 words	Product Name = "ES8508F-S" Word 0 Hi byte = 'E' Word 0 Lo byte = 'S' Word 1 Hi byte = '8' Word 1 Lo byte = '5' Word 2 Hi byte = '0' Word 2 Lo byte = '8' Word 3 Hi byte = 'F' Word 3 Lo byte = '-' Word 4 Hi byte = 'S' Word 4 Lo byte = '\0' (other words = 0)
0x0020	128 words	SNMP system name (string)
0x00A0	128 words	SNMP system location (string)
0x0120	128 words	SNMP system contact (string)
0x01A0	32 words	SNMP system OID (string)
0x01C0	2 words	System uptime (unsigned long)
0x01C2 to 0x01FF	60 words	Reserved address space
0x0200	2 words	Hardware version
0x0202	2 words	S/N information
0x0204	2 words	CPLD version
0x0206	2 words	Bootloader version
0x0208	2 words	Firmware Version Word 0 Hi byte = major Word 0 Lo byte = minor Word 1 Hi byte = reserved Word 1 Lo byte = reserved

Word Address	Data Type	Description
0x020A	2 words	Firmware Release Date Firmware was released on 2010-08-11 at 09 o'clock Word 0 = 0x0B09 Word 1 = 0x0A08
0x020C	3 words	Ethernet MAC Address For example: MAC = 01-02-03-04-05-06 Word 0 Hi byte = 0x01 Word 0 Lo byte = 0x02 Word 1 Hi byte = 0x03 Word 1 Lo byte = 0x04 Word 2 Hi byte = 0x05 Word 2 Lo byte = 0x06
0x0300	2 words	IP address For example: IP = 192.168.250.250 Word 0 Hi byte = 0xC0 Word 0 Lo byte = 0xA8 Word 1 Hi byte = 0x0A Word 1 Lo byte = 0x01
0x020F to 0x2FF	241 words	Reserved address space
0x0302	2 words	Subnet Mask
0x0304	2 words	Default Gateway
0x0306	2 words	DNS Server
0x0308 to 0x3FF	248 words	Reserved address space (IPv6 or others)
0x0400	1 word	AC1 0x0000:Off 0x0001:On 0xFFFF: unavailable
0x0401	1 word	AC2 0x0000:Off 0x0001:On 0xFFFF: unavailable
0x0402	1 word	DC1 0x0000:Off 0x0001:On 0xFFFF: unavailable
0x0403	1 word	DC2 0x0000:Off 0x0001:On 0xFFFF: unavailable
0x0404 to 0x040F	12 words	Reserved address space

Word Address	Data Type	Description
0x0410	1 word	DI1 0x0000:Off 0x0001:On 0xFFFF: unavailable
0x0411	1 word	DI2 0x0000:Off 0x0001:On 0xFFFF: unavailable
0x0412	1 word	DO1 0x0000:Off 0x0001:On 0xFFFF: unavailable
0x0413	1 word	DO2 0x0000:Off 0x0001:On 0xFFFF: unavailable
0x0414 to 0x041F	12 words	Reserved address space
0x0420	1 word	RDY 0x0000:Off 0x0001:On
0x0421	1 word	RM 0x0000:Off 0x0001:On
0x0422	1 word	RF 0x0000:Off 0x0001:On
0x0423	1 word	RS
<b>Port Information (32 Ports)</b>		
0x1000 to 0x11FF	16 words	Port Description
0x1200 to 0x121F	1 word	Administrative Status 0x0000: disable 0x0001: enable
0x1220 to 0x123F	1 word	Operating Status 0x0000: disable 0x0001: enable 0xFFFF: unavailable

Word Address	Data Type	Description
0x1240 to 0x125F	1 word	Duplex 0x0000: half 0x0001: full 0x0003: auto (half) 0x0004: auto (full) 0x0005: auto 0xFFFF: unavailable
0x1260 to 0x127F	1 word	Speed 0x0001: 10 0x0002: 100 0x0003: 1000 0x0004: 2500 0x0005: 10000 0x0101: auto 10 0x0102: auto 100 0x0103: auto 1000 0x0104: auto 2500 0x0105: auto 10000 0x0100: auto 0xFFFF: unavailable
0x1280 to 0x129F	1 word	Flow Control 0x0000: off 0x0001: on 0xFFFF: unavailable
0x12A0 to 0x12BF	1 word	Default Port VLAN ID 0x0001-0xFFFF
0x12C0 to 0x12DF	1 word	Ingress Filtering 0x0000: disable 0x0001: enable
0x12E0 to 0x12FF	1 word	Acceptable Frame Type 0x0000: all 0x0001: tagged frame only
0x1300 to 0x131F	1 word	Port Security 0x0000: disable 0x0001: enable
0x1320 to 0x133F	1 word	Auto Negotiation 0x0000: disable 0x0001: enable 0xFFFF: unavailable

Word Address	Data Type	Description
0x1340 to 0x135F	1 word	Loopback Mode 0x0000: none 0x0001: MAC 0x0002: PHY 0xFFFF: unavailable
0x1360 to 0x137F	1 word	STP Status 0x0000: disabled 0x0001: blocking 0x0002: listening 0x0003: learning 0x0004: forwarding
0x1380 to 0x139F	1 word	Default CoS Value for untagged packets
0x13A0 to 0x13BF	1 word	MDIX 0x0000: disable 0x0001: enable 0x0002: auto 0xFFFF: unavailable
0x13C0 to 0x13DF	1 word	Medium mode 0x0000: copper 0x0001: fiber 0x0002: none 0xFFFF: unavailable
0x13E0 to 0x14FF	288 words	Reserved address space
<b>SFP Information (32 Ports)</b>		
0x1500 to 0x151F	1 word	SFP Type
0x1520 to 0x153F	1 words	Wave length
0x1540 to 0x157F	2 words	Distance
0x1580 to 0x167F	8 words	Vender
<b>SFP DDM Information (32 Ports)</b>		
0x1800 to 0x181F	1 words	Temperature
0x1820 to 0x185F	2 words	Alarm Temperature
0x1860 to 0x187F	1 words	Tx power
0x1880 to 0x18BF	2 words	Warning Tx power
0x18C0 to 0x18DF	1 words	Rx power
0x18E0 to 0x191F	2 words	Warning Rx power
0x1920 to 0x1FFF	1760 words	Reserved address space
<b>Inbound Packet Information</b>		
0x2000 to 0x203F	2 words	Good Octets
0x2040 to 0x207F	2 words	Bad Octets



Word Address	Data Type	Description
0x2080 to 0x20BF	2 words	Unicast
0x20C0 to 0x20FF	2 words	Broadcast
0x2100 to 0x213F	2 words	Multicast
0x2140 to 0x217F	2 words	Pause
0x2180 to 0x21BF	2 words	Undersize
0x21C0 to 0x21FF	2 words	Fragments
0x2200 to 0x223F	2 words	Oversize
0x2240 to 0x227F	2 words	Jabbers
0x2280 to 0x22BF	2 words	Discards
0x22C0 to 0x22FF	2 words	Filtered frames
0x2300 to 0x233F	2 words	RxError
0x2340 to 0x237F	2 words	FCSError
0x2380 to 0x23BF	2 words	Collisions
0x23C0 to 0x23FF	2 words	Dropped Frames
0x2400 to 0x243F	2 words	Last Activated SysUpTime
0x2440 to 0x24FF	191 words	Reserved address space
<b>Outbound Packet Information</b>		
0x2500 to 0x253F	2 words	Good Octets
0x2540 to 0x257F	2 words	Unicast
0x2580 to 0x25BF	2 words	Broadcast
0x25C0 to 0x25FF	2 words	Multicast
0x2600 to 0x263F	2 words	Pause
0x2640 to 0x267F	2 words	Deferred
0x2680 to 0x26BF	2 words	Collisions
0x26C0 to 0x26FF	2 words	SingleCollision
0x2700 to 0x273F	2 words	MultipleCollision
0x2740 to 0x277F	2 words	ExcessiveCollision
0x2780 to 0x27BF	2 words	LateCollision
0x27C0 to 0x27FF	2 words	Filtered
0x2800 to 0x283F	2 words	FCSError
0x2840 to 0x29FF	447 words	Reserved address space
<b>Number of Frames Received and Transmitted with a Length (Octets)</b>		
0x2A00 to 0x2A3F	2 words	64
0x2A40 to 0x2A7F	2 words	65 to 127
0x2A80 to 0x2ABF	2 words	128 to 255
0x2AC0 to 0x2AFF	2 words	256 to 511
0x2B00 to 0x2B3F	2 words	512 to 1023
0x2B40 to 0x2B7F	2 words	1024 to maximum size

## CLI Commands for Modbus TCP/IP

---

---

The CLI commands for Modbus TCP/IP are listed in the following table.

Modbus TCP/IP Commands	
Enable	Switch(config)# modbus enable
Disable	Switch(config)# modbus disable
Set Modbus Interval Time between Request	Switch(config)# modbus idle-timeout <200-10000> Timeout value: 200-10000ms Switch(config)# modbus idle-timeout 200
Set Modbus TCP Master Communicate Session	Switch(config)# modbus master <1-20> Max Modbus TCP Master Switch(config)# modbus master 2
Set Modbus TCP Listening Port	Switch(config)# modbus port <1-65536> Port Number Switch(config)# modbus port 502

# Technical Support

## Control Private MIB

---

---

Control supports many standard MIBs for users to configure or monitor the switch configuration by SNMP. However, since some commands can't be found in standard MIBs, Control provides a Private MIB file. Compile the private MIB file with your SNMP tool. The private MIB can be downloaded it from the [Control FTP Site](#).

The Private MIB tree is the same as the web tree. This is easier to understand and use. If you are not familiar with a standard MIB, you can directly use the private MIB to manage /monitor the switch, without the need to learn or find where the OIDs of the commands are.

## Control Support

---

---

You can use one of the following methods to contact Control.

Contact Method	Web Address or Phone Number
Support	<a href="http://www.control.com/pub/en/support">http://www.control.com/pub/en/support</a>
Downloads	<a href="ftp://ftp.control.com/html/ES8508_main.htm">ftp://ftp.control.com/html/ES8508_main.htm</a>
Web Site	<a href="http://www.control.com">http://www.control.com</a>
Phone	763.957.6000

