



Installation and Configuration Guide



Trademark Notices

Control, NS-Link, and DeviceMaster are trademarks of Control Corporation.

Microsoft and Windows are registered trademarks of Microsoft Corporation.

HyperTerminal is a registered trademark of Hilgraeve, Inc.

Portions of SocketServer are copyrighted by GoAhead Software, Inc. Copyright © 2001. GoAhead Software, Inc. All Rights Reserved.

Other product names mentioned herein may be trademarks and/or registered trademarks of their respective owners.

Fifth Edition, April 4, 2013

Copyright © 2001 - 2013. Control Corporation.

All Rights Reserved.

Control Corporation makes no representations or warranties with regard to the contents of this document or to the suitability of the Control product for any particular purpose. Specifications subject to change without notice. Some software or features may not be available at the time of publication. Contact your reseller for current product information.

Table of Contents

Introduction	9
Supported DeviceMaster Models	9
DeviceMaster Port Usage	9
Installation Overview	10
NS-Link COM Port Driver Installation Overview	11
NS-Link tty Port Installation Overview	11
TCP/IP Socket Port Installation Overview	11
Modbus Server Installation Overview	12
Locating Software and Documentation	12
Connectivity Requirements	14
Developer's Kit	14
Hardware Installation.....	15
Installation Overview	15
1-Port - Enclosed Installation	16
1-Port - Embedded Installation	18
Building the Serial Ribbon Cable	18
Mounting the Embedded	18
Attaching the Network and Serial Cables.....	20
Connecting the Power and Verifying Installation	20
2-Port (Serial Terminal) 1E/2E Installation	22
2-Port (DB9) 1E/2E Installation	24
4-Port and 8-Port Installation.....	26
16-Port (DeviceMaster RTS - External Power Supply) Installation	28
16-Port (DeviceMaster PRO) Installation	30
16/32-Port Rack Mount Models (Internal Power Supply) Installation.....	32
Initial Configuration	35
PortVision Plus	35
PortVision DX Overview	35
PortVision DX Requirements.....	36
Configuring Security Settings and PortVision DX.....	36
Installing PortVision DX.....	37
Configuring the Network Settings	40
Checking the SocketServer Version	43
Uploading SocketServer with PortVision DX.....	45
Uploading Modbus Server	47
Customizing PortVision DX	49
Accessing DeviceMaster Documentation from PortVision DX.....	50
How to Download Documentation	50
How to Open Previously Downloaded Documents	51

Device Driver (NS-Link) Installation53

- Overview 53**
 - Before Installing the NS-Link Driver 53
 - Existing Installations 53
 - Drivers (Windows) before v10.xx 54
 - Drivers (Linux) before 5.00 54
- Linux Installations55**
- Windows Installations56**
 - Supported Operating Systems 56
 - Installation Overview for Windows 56
 - NS-Link for Windows Installation 56
- Configuring the NS-Link Driver for Windows 60**
- Configuring COM Port Properties for Windows 64**
- Enabling Secure Data Mode..... 65**

Socket Port Configuration67

- SocketServer Overview 67**
 - Web Page Help System 67
 - SocketServer Architecture 68
- Accessing Socket Configuration 69**
 - Web Browser 69
 - PortVision DX 69
- SocketServer Versions 70**

DeviceMaster Security71

- Understanding Security Methods and Terminology 71**
- TCP and UDP Socket Ports Used by the DeviceMaster 76**
- DeviceMaster Security Features..... 77**
 - Security Modes 77
 - Secure Data Mode and Secure Config Mode Comparison 78
 - Security Comparison 78
 - SSH Server 79
 - SSL Overview 79
 - SSL Authentication 79
 - Server Authentication 79
 - Client Authentication 80
 - Certificates and Keys 80
 - SSL Performance 82
 - SSL Cipher Suites 82
 - DeviceMaster Supported Cipher Suites 83
 - SSL Resources 83
- Configure/Enable Security Features Overview 84**
 - Example 1 86
 - Example 2 86
 - Example 3 87
 - Key and Certificate Management 87
- Using a Web Browser to Set Security Features 89**
 - Changing Security Configuration 89
 - Changing Keys and Certificates 90

Modbus Server Application Overview	91
Recommended Chassis	91
What is Modbus?	92
Modbus/RTU (Supported by Modbus Server).....	92
Modbus/TCP (Not supported by Modbus Server).....	92
Modbus Server Functionality	93
Connecting Serial Devices	95
DB9 Connectors	95
DB9 Null-Modem Cables (RS-232)	96
DB9 Null-Modem Cables (RS-422)	96
DB9 Straight-Through Cables (RS-232/485).....	96
DB9 Loopback Plugs.....	97
Connecting DB9 Serial Devices	97
RJ45 Connectors	98
RJ45 Null-Modem Cables (RS-232)	98
RJ45 Null-Modem Cables (RS-422)	99
RJ45 Straight-Through Cables (RS-232/485).....	99
RJ45 Loopback Plugs.....	99
RJ45 RS-485 Test Cable.....	99
Connecting RJ45 Devices	100
Serial Terminals (4) - 1E.....	101
Serial Terminal (4) Connectors	101
Serial Terminal (4) Null-Modem Cables (RS-232)	102
Serial Terminal (4) Null-Modem Cables (RS-422)	102
Serial Terminal (4) Straight-Through Cables (RS-232/485)	102
Serial Terminal (4) Loopback Signals	103
Connecting Serial Devices	103
Serial Terminals (8) - 2E.....	104
Serial Terminal (8) Connectors	104
Serial Terminal (8) Null-Modem Cables (RS-232)	105
Serial Terminal (8) Null-Modem Cables (RS-422)	105
Serial Terminal (8) Straight-Through Cables (RS-232/485)	105
Serial Terminal (8) Loopback Signals	106
Connecting Serial Devices	106
Managing the DeviceMaster	107
Rebooting the DeviceMaster.....	107
Updating Firmware Across WANs (Windows)	108
Uploading SocketServer to Multiple DeviceMasters	113
Configuring Multiple DeviceMasters Network Addresses	115
Adding a New Device.....	115
Remote Using the IP Address	115
Local Using the IP Address or MAC Address	116
Using SocketServer Configuration Files	117
Saving a SocketServer Configuration File	117
Loading a SocketServer Configuration File	118
Using Driver Configuration Files	119
Saving Driver Configuration Files.....	119
Loading Driver Configuration Files.....	120
Loading Device Configuration	120
Loading Port Configuration	122

Changing the Bootloader Timeout	124
Properties Screen.....	124
Network Web Page (SocketServer 6.05 - 8.xx).....	125
Telnet/SSH Session (SocketServer v6.04 and Below).....	127
Managing Bootloader	128
Checking the Bootloader Version.....	128
Uploading Bootloader	128
Checking the NS-Link Version	130
Restoring Factory Defaults (2-Port, Only).....	131
Restoring Serial Port Settings.....	132
NS-Link COM Port.....	132
Socket Port.....	132
RedBoot Procedures.....	133
Accessing RedBoot Overview	133
Establishing a Serial Connection	134
Establishing a Telnet Connection.....	135
Determining the Network Settings	135
Configuring the Network Settings	136
Changing the Bootloader Timeout	136
Determining the Bootloader Version.....	137
Resetting the DeviceMaster	137
Uploading Firmware - Telnet Method (Linux)	138
Setting Up a TFTP Server in Linux	138
Uploading the Firmware	139
Configuring Passwords	140
RedBoot Command Overview.....	141
Hardware Specifications.....	143
Locating DeviceMaster Specifications	143
External Power Supply Specifications.....	144
1-Port 5VDC Power Supply.....	144
1-Port 5-30VDC Power Supply.....	144
2-Port (Serial Terminals) Power Supply	145
2-Port (DB9) Power Supply	145
4-Port Power Supply	146
8-Port Power Supply	146
16-Port Power Supplies	146
DeviceMaster Product Pictures	147
1-Port (DB9) 5VDC	148
1-Port (DB9) 5-30VDC.....	148
1-Port Embedded	149
2-Port (Single Ethernet Port) with Serial Terminals	149
2-Port (Dual Ethernet Ports) with Serial Terminals.....	150
2-Port (Single Ethernet Port) DB9	150
2-Port (Dual Ethernet Ports) DB9	151
4-Port (DB9).....	151
8-Port (DB9).....	151
16-Port (RJ45) External Power Supply	151
16-Port (RJ45) Internal Power Supply	152
DeviceMaster PRO 16-Port (RJ45)	152
DeviceMaster Serial Hub 16-Port (DB9).....	152
DeviceMaster RTS 32-Port (RJ45).....	152

Notices	153
Radio Frequency Interference (RFI) (FCC 15.105).....	153
Labeling Requirements (FCC 15.19).....	153
Modifications (FCC 15.21).....	153
Serial Cables (FCC 15.27).....	153
Underwriters Laboratory.....	153
Important Safety Information.....	153
Troubleshooting and Technical Support	155
Troubleshooting Checklist	155
General Troubleshooting	157
Testing Ports Using Port Monitor (PMon2)	159
Overview	159
Testing Control COM Ports.....	159
Testing Ports Using Test Terminal	162
Overview	162
Opening Ports	163
Sending and Receiving Test Data (RS-232/422/485: 4-Wire)	163
Loopback Test (RS-232).....	164
Sending and Receiving Data (RS-485: 2-Wire)	165
Socket Mode Serial Port Testing	168
Daisy-Chaining DeviceMaster 2E/4/8/16-Port Units	173
DeviceMaster LEDs	174
TX/RX LEDs.....	174
Network and Device LEDs	175
Removing DeviceMaster Security Features	177
Serial Connection Method	177
Returning the DeviceMaster to Factory Defaults	179
Clearing the Flash	180
Clearing EEPROM.....	180
Telnet Access	180
Serial Port Access	181
Web Server Access.....	181
Technical Support	182

Introduction

This section discusses the following topics:

- [Supported DeviceMaster Models](#) on Page 9
- [DeviceMaster Port Usage](#) (below)
- [Installation Overview](#) on Page 10
 - [NS-Link COM Port Driver Installation Overview](#) on Page 11
 - [NS-Link tty Port Installation Overview](#) on Page 11
 - [TCP/IP Socket Port Installation Overview](#) on Page 11
 - [Modbus Server Installation Overview](#) on Page 12
- [Locating Software and Documentation](#) on Page 12
- [Connectivity Requirements](#) on Page 14
- [Developer's Kit](#) on Page 14

Supported DeviceMaster Models

This *Installation and Configuration Guide* supports the DeviceMaster platform, which includes the following models:

- DeviceMaster PRO
- DeviceMaster RTS
- DeviceMaster Serial Hub

The *Guide* refers to DeviceMaster unless there is model-specific information. FTP links in this *Guide* typically point to an **RTS** subdirectory, where the file resides that supports all DeviceMaster models.

DeviceMaster Port Usage

DeviceMaster serial ports can be configured for many environments, which include the following:

- *COM port* (or secure COM ports) when the NS-Link driver for Windows is installed
- *tty ports* when the NS-Link driver for Linux is installed
- *Socket ports* when SocketServer or the NS-Link web page is configured accordingly
- *Modbus Server ports* when the Modbus Server firmware is uploaded and configured

Installation Overview

DeviceMaster installation and configuration follows these steps:

1. **Hardware installation.**

Power up the DeviceMaster. Technical Support suggests installing one DeviceMaster at a time to avoid configuration problems using [Hardware Installation](#) on Page 15.

2. **Install PortVision DX.**

Note: *PortVision DX replaces PortVision Plus. PortVision Plus does not support operating systems above Windows 7 and SocketServer versions above 9.00.*

Control recommends connecting the DeviceMaster to a PC or laptop running Windows and that you install PortVision DX for easy IP address configuration and firmware updates. See [PortVision DX Requirements](#) on Page 36 and refer to [Installing PortVision DX](#) on Page 37 to install PortVision DX.

3. **Program the IP address.**

See [Configuring the Network Settings](#) on Page 40 for detailed configuration procedures.

4. **If necessary, update SocketServer.**

Note: *Technical Supports recommends that you update to the latest version of SocketServer before installing any NS-Link device driver or configuring socket ports.*

This step is not required if you planning on uploading Modbus Server onto the DeviceMaster.

If you have existing installations with NS-Link, you should review [Existing Installations](#) on Page 53 for additional information about NS-Link changes.

- a. Check the SocketServer version using [Checking the SocketServer Version](#) on Page 43 to determine the version on the DeviceMaster.
- b. If necessary, update SocketServer. See [Uploading SocketServer with PortVision DX](#) on Page 45.

Note: *In rare cases, you may need to update Bootloader to support a new feature. Notice will posted with SocketServer or the NS-Link device driver.*

5. Go to the appropriate overview or overviews for your installation:

- **NS-Link COM ports (or secure COM ports)** - [NS-Link COM Port Driver Installation Overview](#) on Page 11
- **NS-Link tty ports** - [NS-Link tty Port Installation Overview](#) on Page 11
- **TCP/IP socket ports** - [TCP/IP Socket Port Installation Overview](#) on Page 11
- **Modbus Server ports** - [Modbus Server Installation Overview](#) on Page 12

NS-Link COM Port Driver Installation Overview

Use the following overview, which are discussed in detail in the subsequent sections, to install and configure the DeviceMaster to run the NS-Link device driver for [Windows](#) operating systems..

1. After connecting the DeviceMaster, programming the IP address with PortVision DX, and uploading the latest version of SocketServer, you are ready to install the driver.
2. Install the NS-Link device driver.
See [Windows Installations](#) on Page 56 for an installation overview of the NS-Link driver for Windows operating systems.
For detailed installation and configuration information, see the *DeviceMaster NS-Link Device Driver User Guide* on the CD or download the latest from the ftp site at: ftp://ftp.comtrol.com/dev_mstr/rts/drivers/win7/sw_doc/.
Note: *Although the ftp link displays win7 in the path, the driver supports multiple [Windows](#) operating systems (Page 36).*
3. Configure the COM ports using the *Control Drivers Management Console*. See [Configuring the NS-Link Driver for Windows](#) on Page 60, which provides an overview of COM port configuration.
4. Configure device properties, you can refer to [Configuring COM Port Properties for Windows](#) on Page 64.
5. Optionally, you may need to configure one or more ports for socket mode. See [Socket Port Configuration](#) on Page 67 for information about configuring socket ports using the Server Configuration web page.
6. Connect the serial devices to the DeviceMaster. Refer to [Connecting Serial Devices](#) on Page 95 for cabling and connector information.

NS-Link tty Port Installation Overview

Use the following steps, which are discussed in detail in the subsequent sections, to install and configure the DeviceMaster to run the NS-Link device driver for Linux operating systems.

1. After connecting the DeviceMaster, programming the IP address, and uploading the latest version of SocketServer, you are ready to install the driver.
2. Locate and unpackage the driver assembly. You can use the CD to access the ftp site ftp://ftp.comtrol.com/dev_mstr/rts/drivers/linux/ to locate the latest version of NS-Link Linux device driver.
Refer to the **readme** file packaged with the Linux driver assembly for driver installation and configuration procedures for the tty port.
3. Optionally, you may need to configure one or more ports for socket mode. See [Socket Port Configuration](#) on Page 67 for information about configuring socket ports using the web interface (SocketServer/NS-Link).
4. Connect the serial devices to the DeviceMaster. Refer to [Connecting Serial Devices](#) on Page 95 for cabling and connector information.

TCP/IP Socket Port Installation Overview

Use the following steps, which are discussed in detail in the subsequent sections, to configure DeviceMaster socket ports.

1. After connecting the DeviceMaster, programming the IP address, and uploading the latest version of SocketServer, you are ready to configure socket port or serial tunneling.
2. Configure the serial socket ports using the PortVision DX property pages or enter the IP address in a web browser and use the SocketServer web pages.
You can refer to the SocketServer help system or [Socket Port Configuration](#) on Page 67 for information for configuration procedures.
3. Connect the serial devices to the DeviceMaster. Refer to [Connecting Serial Devices](#) on Page 95 for cabling and connector information.

Modbus Server Installation Overview

Use the following steps, which are discussed in detail in the subsequent sections, to configure DeviceMaster for Modbus Server ports.

Note: Only load the Modbus Server firmware if you want exclusively Modbus Server ports on the DeviceMaster.

1. After connecting the DeviceMaster and programming the IP address, you are ready to upload and configure Modbus Server firmware. For information about Modbus Server, see [Modbus Server Application Overview](#) on Page 91.
2. Upload Modbus Server using PortVision DX.
You can use the CD or the web site to locate the latest version of Modbus Server at: <http://www.comtrol.com/content/downloads/>. See [Uploading Modbus Server](#) on Page 47 to upload Modbus Server.
3. Use the *Modbus Server User Guide* to configure the DeviceMaster port, which is available on the CD or you can download the latest version from the ftp site: ftp://ftp.comtrol.com/dev_mstr/rts/software/modbus_server/docs/modbus_server_user_guide.pdf to configure the DeviceMaster ports.
4. Connect the serial devices to the DeviceMaster. Refer to [Connecting Serial Devices](#) on Page 95 for cabling and connector information.

Locating Software and Documentation





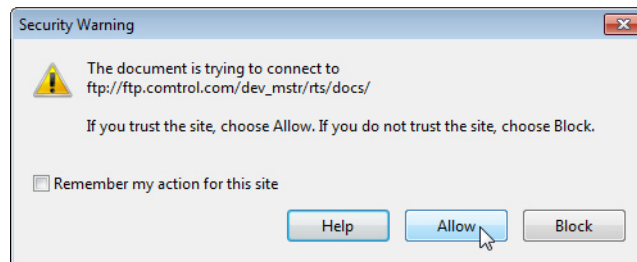

You can access the appropriate software assembly, PortVision DX, and DeviceMaster documentation from the Comtrol ftp site using any of these methods:

- *Control Software and Documentation* CD shipped with the DeviceMaster provides links to the latest files.
- PortVision DX features a Documentation option that you can use to download and later access documentation from within PortVision DX. See [Accessing DeviceMaster Documentation from PortVision DX](#) on Page 50 for more information.
- Check for and download the latest files using the links in the following table.

Note: Depending on your Windows operating system you may need to respond to a Security Warning popup.



If you are not sure what files are required for your installation, each [Installation Overview](#) subsection also provides links to the required files in this *Guide*.

Software		Description/Documentation	File
Configuration Application	PortVision DX	Install on a Windows host to configure the IP address and upload SocketServer on the DeviceMaster. PortVision DX replaces PortVision Plus. PortVision Plus does not support operating systems above Windows 7 and SocketServer versions above v9.00 or NS-Link device driver v10.xx.	
SocketServer	SocketServer	This is the firmware that comes pre-installed on your DeviceMaster platform. You may need to upload the latest version of SocketServer before installing and configuring drivers or configuring sockets.	
Device Driver	Linux	Install if you want tty ports. Refer to the Readme file compressed in the Linux driver assembly for driver configuration procedures.	
	Windows 8 Windows Server 2012 Windows 7 Windows Server 2008 Windows Vista Windows Server 2003 Windows XP	Install if you want COM ports. Refer to the DeviceMaster Device Driver (NS-Link) User Guide . for detailed information.	
Bootloader	Bootloader	The operating system that runs on the DeviceMaster hardware during the power on phase, which then loads SocketServer. Only update the Bootloader on your DeviceMaster if advised by Technical Support or the ftp site when checking for the latest SocketServer or device driver version.	
Modbus Server	Modbus Server	The Modbus Server firmware was designed to provide enhanced connectivity for OPC servers and applications that require Modbus/RTU communication from Ethernet TCP/IP or COM ports directly to serial ports. Refer to the Modbus Server User Guide for more information.	
This Guide	Any	You can check for the latest version of this <i>Installation and Configuration Guide</i> .	

Connectivity Requirements

An Ethernet connection: either to an Ethernet hub, switch, or router; or to a Network Interface Card (NIC) in the host system using a standard Ethernet cable.

Product Type	Connected to	Connector Name
DeviceMaster RTS 1-port	Hub, switch, router, or NIC	10/100 ETHERNET
DeviceMaster RTS Embedded	Hub, switch, router, or NIC	RJ45 port (not labeled)
DeviceMaster RTS 2-port 1E	NIC	10/100
	Hub, switch, or router	
DeviceMaster RTS 2-port 2E	NIC	10/100 1E/2E
	Hub, switch, or router	
DeviceMaster RTS 4/8/16-port (external power supply)	NIC	DOWN
	Hub, switch, or router	UP
DeviceMaster RTS 16/32RM (internal power supply)	Hub, switch, router, or NIC	10/100 NETWORK
DeviceMaster PRO 8/16-port	NIC	DOWN
	Hub, switch, or router	UP
DeviceMaster Serial Hub 8-port	NIC	DOWN
	Hub, switch, or router	UP
DeviceMaster Serial Hub 16-port	Hub, switch, router, or NIC	10/100 NETWORK

Developer's Kit

In addition to the standard capabilities of the DeviceMaster they are also a fully-programmable, embedded computing platform.

If you are interested in writing your own applications for the DeviceMaster or would like information on how to obtain the Control DeviceMaster Developer's Kit, see <http://www.comtrol.com/pub/en/DeviceMaster-SDK-Support> or please contact your Control sales representative.

Note: *The DeviceMaster PRO is shipped with the Developer's Kit. The DeviceMaster RTS supports the Developer's Kit. The DeviceMaster Serial Hub is not supported in the Developer's Kit.*

Hardware Installation

Installation Overview

Use the links below to locate installation procedures for the following models:

DeviceMaster PRO

DB9 serial ports with dual Ethernet†† ports	8†	4-Port and 8-Port Installation on Page 26
RJ45 serial ports with dual Ethernet†† ports	16	16-Port (DeviceMaster PRO) Installation on Page 30

Default Network Settings

IP address:
192.168.250.250

Subnet mask:
255.255.0.0

Gateway address:
192.168.250.1

DeviceMaster RTS

DB9 serial port with a single Ethernet port	1	1-Port - Enclosed Installation on Page 16
Embedded system	1	1-Port - Embedded Installation on Page 18
Screw terminal serial ports	2‡	2-Port (Serial Terminal) 1E/2E Installation on Page 22
DB9 serial ports	2‡	2-Port (DB9) 1E/2E Installation on Page 24
DB9 serial ports with dual Ethernet†† ports	4† or 8†	4-Port and 8-Port Installation on Page 26
RJ45 serial ports with dual Ethernet†† ports	16	16-Port (DeviceMaster RTS - External Power Supply) Installation on Page 28
RJ45 serial ports with a single Ethernet port	16 or 32	16/32-Port Rack Mount Models (Internal Power Supply) Installation on Page 32

DeviceMaster Serial Hub

DB9 serial ports with dual Ethernet†† ports	8	4-Port and 8-Port Installation on Page 26
DB9 serial ports with a single Ethernet port	16	16/32-Port Rack Mount Models (Internal Power Supply) Installation on Page 32

† The DeviceMaster RTS 4 and 8-port models may also include DB9 to RJ45 adapters.

†† One of the Ethernet ports on the DeviceMaster is a built-in downstream port for daisy-chaining DeviceMaster systems or other network-ready devices.

‡ Either Ethernet port on the DeviceMaster RTS 2-port 2E model can be used for daisy-chaining DeviceMaster systems or other network-ready devices.

1-Port - Enclosed Installation

Use the following procedure to install the DeviceMaster 1-Port.

1. Record the MAC address and serial number of the DeviceMaster on the customer service label provided.

You may need the MAC address during driver configuration. The MAC address (starts with **00 C0 4E**) and serial number are located on a label on the DeviceMaster.

Note: Do not connect multiple units until you have changed the default IP address, see [Initial Configuration](#) on Page 35.

2. Place the 1-Port on a stable surface and skip to [Step 3](#) or optionally mount the DeviceMaster using the mounting flanges or DIN rail adapters.

- a. Pick up the DeviceMaster so that the front of the device is facing you.
- b. Pick up a DIN rail clip. (The three tines should be on top and the M4 label should face you.)
- c. Slide the DIN rail clip behind the DeviceMaster and line it up with one of the screw holes on the DeviceMaster.
- d. Insert the M4 screw into the hole and tighten with a Phillips screwdriver.
- e. Repeat [Steps b](#) through d with the second DIN rail clip. Make sure the screws on both DIN rail clips line up.

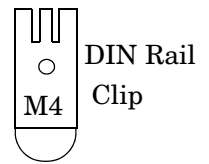

- f. Attach the DeviceMaster to the DIN rail.

Note: If you need to remove the DeviceMaster from the DIN rail, exert pressure on the backside of the tabs at the bottom of both DIN rail clips.

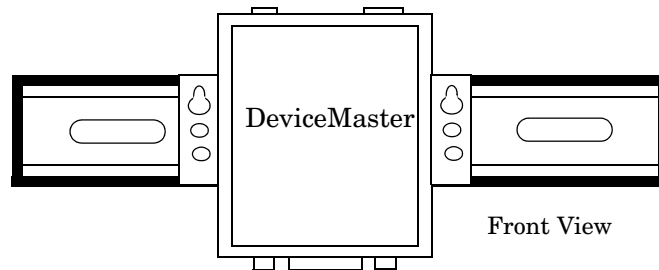
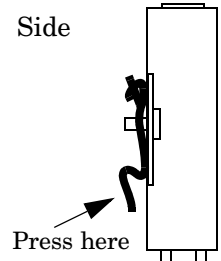

3. Connect the DeviceMaster port labeled **10/100 ETHERNET** to the same Ethernet network segment as the host PC using a standard network cable.

If you plan on using the NS-Link device driver, make sure that you do not connect RS-422/485 devices until the appropriate port interface type has been configured in the driver. The NS-Link default port setting is RS-232.



Caution

4. Apply power to the DeviceMaster using the appropriate procedure for your power supply.

Note: The supported input voltage (5VDC or 5-30VDC) is printed on the DeviceMaster.

5VDC Power Supply (Barrel Connector)

- Connect the 5VDC power supply to the DeviceMaster and to a power outlet.
- Go to [Step 5](#) to verify that the DeviceMaster is functioning properly.

5-30VDC with Screw Terminal Power Connector

Use the following procedure power on this model.

Observe proper ESD techniques when connecting and disconnecting the DeviceMaster.



Caution

- Insert the earth ground wire into the earth ground screw terminal.
- Insert the DC positive wire into the positive screw terminal and the DC return wire into the return screw terminal.

If you purchased the Control power supply (separately), the wires are identified below:

- Red = 5-30VDC positive
- White = 5-30VDC return
- Black = earth ground

If you did not purchase a power supply from Control for the DeviceMaster, see [1-Port 5-30VDC Power Supply](#) on Page 144 for power requirements.

Screw Terminal Power Connector

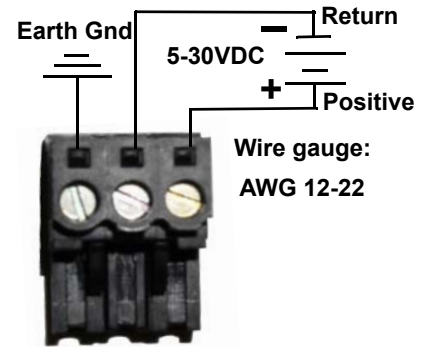

- Use a small flat head screw to lock the wires into place.
- Verify that each wire has been tightened securely.
- Plug the screw terminal power connector into the DeviceMaster.

Note: Align the plug properly. The scalloped side of the screw terminal power connector should be aligned with the scalloped side of the power jack on the unit.



- Connect the power supply to a power source.
 - Go to [Step 5](#) to verify that the DeviceMaster is functioning properly.
5. Verify that the **Status** LED has completed the boot cycle and network connection for the DeviceMaster is functioning properly using the table below.

1-Port Enclosed LED Descriptions	
Status	The amber Status LED on the device is lit, indicating you have power and it has completed the boot cycle. Note: The Status LED flashes while booting and it takes approximately 15 seconds for the Bootloader to complete the cycle. When the Bootloader completes the cycle, the LED has a solid, steady light that blinks approximately every 10 seconds.
Link/Act	If the red Link/Act LED is lit, it indicates a working Ethernet connection.
Duplex	If the red Duplex LED is lit, it indicates full-duplex activity.
100	If the red 100 LED is lit, it indicates a working 100 MB Ethernet connection (100 MB network, only). If the LED is not lit, it indicates a 10 MB Ethernet connection.
Note: For additional LED information, go to the Status LED table on Page 156.	

6. Go to [Initial Configuration](#) on Page 35 for default network settings and how to configure the DeviceMaster for use.

1-Port - Embedded Installation

Installing the DeviceMaster 1-Port Embedded system follows these basic steps:

- Building the serial ribbon cable (below).
- [Mounting the Embedded](#) on Page 18 and installing light pipes.
- [Attaching the Network and Serial Cables](#) on Page 20.
- [Connecting the Power and Verifying Installation](#) on Page 20.



Caution

Observe proper ESD techniques when handling the DeviceMaster.

Building the Serial Ribbon Cable

Use the following information to build a DB9 serial ribbon cable to connect to the DeviceMaster 1-Port Embedded IDC10 connector (J3).

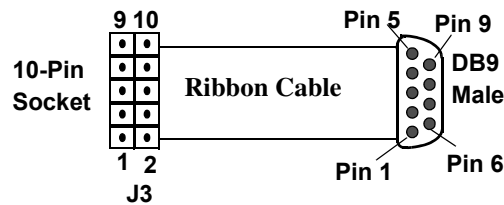

J3 Header	RS-232	RS-422	RS-485
1	CD	Not used	Not used
2	DSR	Not used	Not used
3	RxD	RxD-	Not used
4	RTS	TxD+	TRX+
5	TxD	TxD-	TRX-
6	CTS	RxD+	Not used
7	DTR	Not used	Not used
8	RI	Not used	Not used
9	GND	Not used	Not used
10	Not connected		

Mounting the Embedded



Caution

Use the following procedure to mount the DeviceMaster 1-Port Embedded with the 5-30VDC power supply.

Observe proper ESD techniques when handling the DeviceMaster.

1. Carefully remove the DeviceMaster from the anti-static bag, following standard electrostatic device handling procedures.

Note: Write down the MAC address located on a label on the bottom (solder side) center of the DeviceMaster because you may need it during configuration.

2. Mount the DeviceMaster for your environment using 1/4" stand-offs to separate the DeviceMaster from the base.

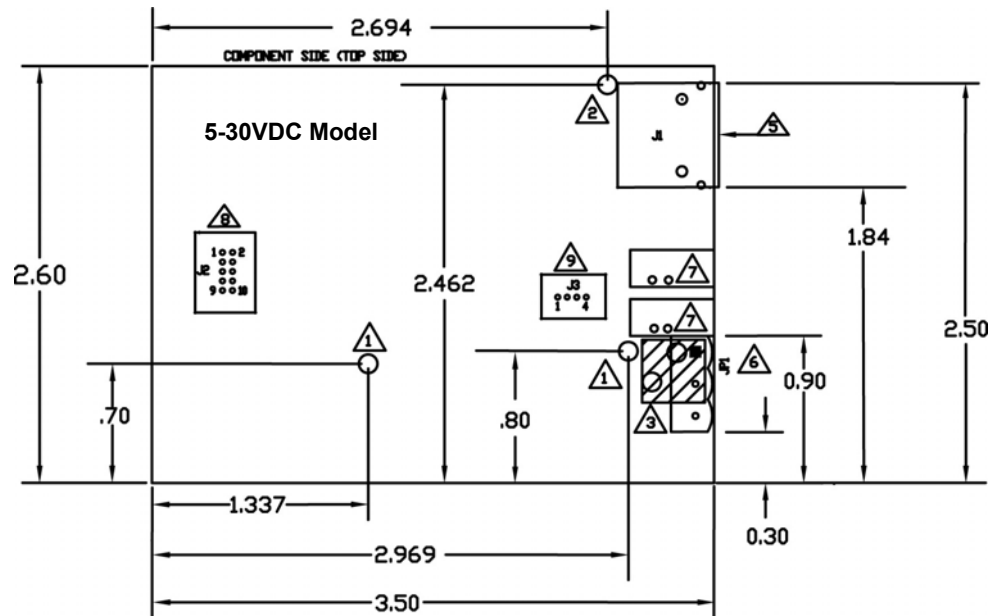

- 1 Non-plated/non-grounded mounting holes 0.116" diameter (+/-0.003").
- 2 Plated/chassis grounded mounting hole 0.116" diameter (+/-0.003").
- 3 WARNING: Holes in hatched area are not mounting holes.
- 4 Maximum component height above board is 0.55".
- 5 Ethernet connection J2: J2 overhangs board edge by 0.14" and the height is 0.55".
- 6 Power connector; the mating connector is Weidmuller P/N: 152651.
- 7 LED light pipe mounting holes. The LED light pipes are not provided.
- 8 Serial port connector J3: 0.1" pin spacing, 0.025" square pin diameter, and 0.230" pin height.
- 9 Debug port connector J4: 0.1" pin spacing, 0.025" square pin diameter, and 0.230" pin height.



3. Use one of the following methods to ground the DeviceMaster.
- Through the **power supply** by connecting the ground wire on the power cable using plastic or metal stand-offs.
 - Through the **chassis**, using metal stand-offs. If plastic stand-offs are used to mount the board, then you must ground the DeviceMaster using the power cable.

Note: The maximum diameter of the metal stand-offs should be 0.175" with a 4-40 machine screw. Metal stand-offs are not provided with the DeviceMaster.

4. Optionally, attach the light pipes. The following light pipes have been tested and found to function; Bivar, Inc. (P/N:LP-230) and Ledtronics, Inc. (P/N:LTP003-0CW-001).

After mounting the DeviceMaster, you are ready to connect the cables.

Attaching the Network and Serial Cables

Use the following procedure to attach the serial ribbon and Ethernet cables. For a larger illustration of the system, see [1-Port Embedded](#) on Page 149.

1. Attach the ribbon cable built in [Building the Serial Ribbon Cable](#) on Page 18 to the header labeled **J3**.

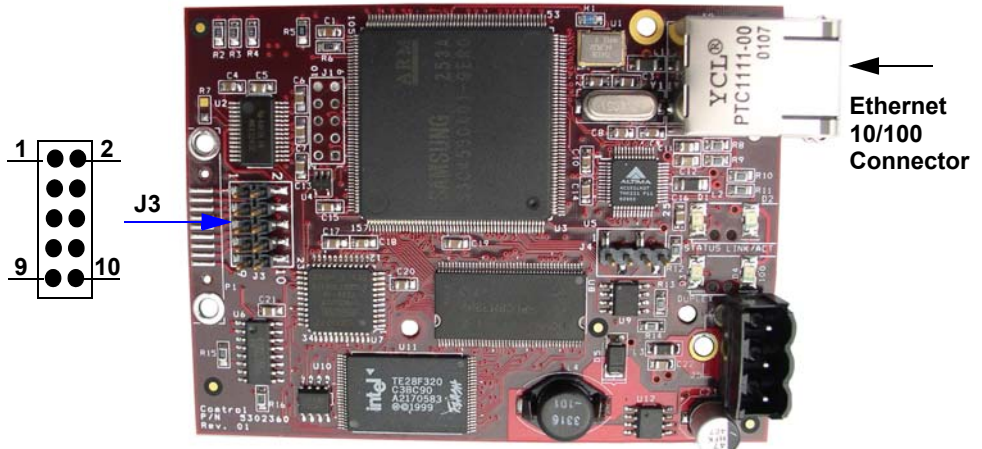

2. Connect a standard Ethernet cable from the RJ45 port on the DeviceMaster to your Ethernet hub.

The default serial port setting on the DeviceMaster is RS-232. Do not connect the serial device until you have configured the serial port settings. You must configure network settings and upload firmware before configuring the serial port settings.



Use the next subsection to wire the power terminal connector and verify the hardware installation.

Connecting the Power and Verifying Installation

Use the following procedure to wire the power terminal connector and connect the DeviceMaster to a power source.

Observe proper ESD techniques when connecting and disconnecting the DeviceMaster.



1. Insert the earth ground wire into the earth ground screw terminal.
2. Insert the DC positive wire into the positive screw terminal and the DC return wire into the return screw terminal.

If you purchased the Control power supply (separately), the wires are identified below:

- Red = 5-30VDC positive
- White = 5-30VDC return
- Black = earth ground

If you did not purchase a power supply from Control for the DeviceMaster, see [1-Port 5-30VDC Power Supply](#) on Page 144 for power requirements.

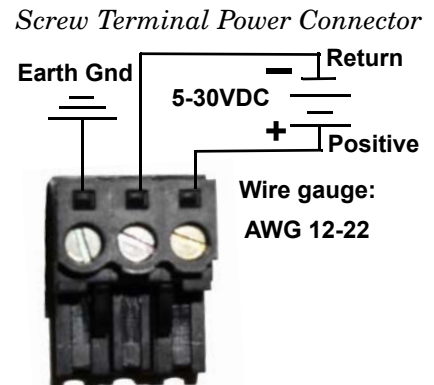

3. Use a small flat head screw to lock the wires into place.
4. Verify that each wire has been tightened securely.
5. Plug the screw terminal power connector into the DeviceMaster.
6. Connect the power supply to a power source.

7. Plug the screw terminal power connector into **JP1** on the DeviceMaster by aligning the scalloped sides.

***Note:** Align the plug properly. The scalloped side of the screw terminal power connector should be aligned with the scalloped side of the power jack on the unit.*

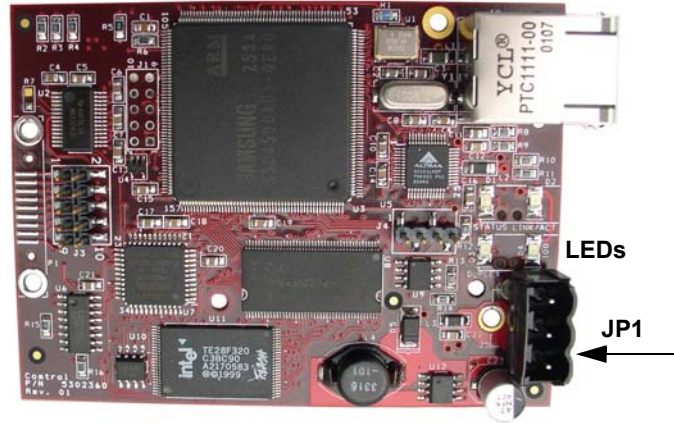

8. Apply power to the DeviceMaster.
9. Verify the **Status** LED has completed the boot cycle and network connection for the DeviceMaster is functioning properly using the table below.

The LEDs are located between the RJ45 connector and the power terminal block.

1-Port Embedded LED Descriptions	
Status	When lit, the amber Status LED (D1) on the DeviceMaster indicates the devices is fully powered and has completed the boot cycle. <i>Note: The Status LED flashes for approximately 15 seconds while booting. When the Bootloader completes the cycle, the LED has a solid, steady light that blinks approximately every 10 seconds.</i>
Link/Act	When lit, the red Link/Act LED (D2) indicates a working Ethernet connection.
Duplex	When lit, the red Duplex (D3) LED indicates full-duplex activity.
100	When lit, the red 100 (D4) LED indicates a working 100 MB Ethernet connection (100 MB network, only). If the LED is not lit, it indicates a 10 MB Ethernet connection.
<i>Note: For additional LED information, go to the Status LED table on Page 156.</i>	

10. Go to [Initial Configuration](#) on Page 35 for default network settings and how to configure the DeviceMaster for use.

2-Port (Serial Terminal) 1E/2E Installation

Use the following procedure to install DeviceMaster 2-port models with serial terminal connectors. See [2-Port \(DB9\) 1E/2E Installation](#) on Page 24 if the DeviceMaster has DB9 serial connectors.

1. Record the MAC address and serial number of the DeviceMaster unit on the customer service label provided.
You may need the MAC address during driver configuration. The MAC address (starts with **00 C0 4E**) and serial number are located on a label on the DeviceMaster.
2. Attach the DeviceMaster 2-Port to the DIN rail adapter.
3. Connect the power supply and apply power to the DeviceMaster using the power supply specifications on the product label and the following information.



Caution

Observe proper ESD techniques when connecting and disconnecting the DeviceMaster.

- a. Insert the earth ground wire into the chassis ground screw terminal. The chassis ground connection is made only if the DIN rail is NOT connected to signal ground.
- b. Insert the DC positive wire into the + screw terminal and the DC return wire into the - screw terminal.

If you purchased the Control power supply (separately), the wires are identified below:

- Red = 5-30VDC positive
- White = 5-30VDC return
- Black = chassis ground

If you did not purchase a power supply from Control for the DeviceMaster, see [2-Port \(Serial Terminals\) Power Supply](#) on Page 145 for power requirements.

- c. Use a small flat head screw driver to lock the wires into place.
- d. Verify that each wire has been tightened securely.
- e. Connect the power supply to a power source.

Note: Do not connect multiple units until you have changed the default IP address, see [Initial Configuration](#) on Page 35.

4. Use the appropriate method for network attachment of your DeviceMaster 2-port:

DeviceMaster 1E: Connect the **10/100 port** to the same Ethernet network segment as the host PC using a standard network cable.

DeviceMaster 2E: Connect the DeviceMaster 2E using one of these methods:

- **Ethernet hub, switch (10/100Base-T), Server NIC (10/100Base-T):** Connect a **10/100 port** to the same Ethernet network segment as the host PC using a standard Ethernet cable.

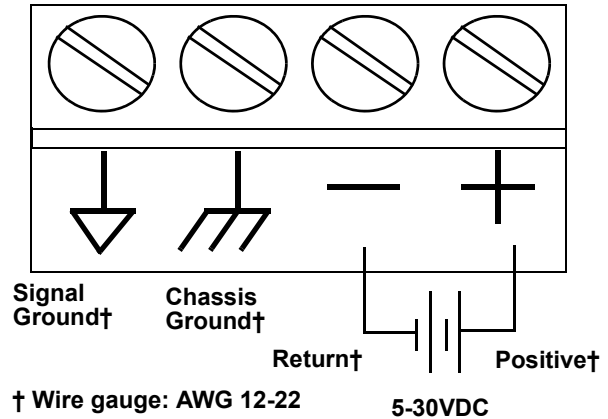

Signal Ground is used to connect RS-232 devices later in the installation.

- **Daisy-chaining DeviceMaster units:** Connect the port labeled E1 (or E2) on the first DeviceMaster to the port labeled E1 (or E2) on the second DeviceMaster or other device using a standard Ethernet cable. Refer to [Daisy-Chaining DeviceMaster 2E/4/8/16-Port Units](#) on Page 173 for more detailed information.



Do not connect RS-422/485 devices until the appropriate port interface type has been configured. The default port setting is RS-232.

5. Verify that the **Status LED** has completed the boot cycle and network connection for the DeviceMaster is functioning properly using the following table.

2-Port Serial Terminal LED Descriptions	
STATUS	The STATUS LED on the device is lit, indicating you have power and it has completed the boot cycle. <i>Note: The STATUS LED flashes while booting and it takes approximately 15 seconds for the Bootloader to complete the cycle. When the Bootloader completes the cycle, the LED has a solid, steady light that blinks approximately every 10 seconds.</i>
LINK	If the LINK (green) LED is lit, it indicates a working Ethernet connection.
ACT	If the ACT (yellow) LED flashes, it indicates network activity.
<i>Note: For additional LED information, go to the Status LED table on Page 156.</i>	

6. Go to [Initial Configuration](#) on Page 35 for default network settings and how to configure the DeviceMaster for use.

2-Port (DB9) 1E/2E Installation

Use the following procedure to install DeviceMaster 2-port models with DB9 connectors.

1. Record the MAC address and serial number of the DeviceMaster unit on the customer service label provided.
You may need the MAC address during driver configuration. The MAC address (starts with **00 C0 4E**) and serial number are located on a label on the DeviceMaster.
2. Attach the DeviceMaster 2-Port to the DIN rail adapter.
3. Connect the power supply and apply power to the DeviceMaster using the power supply specifications on the product label and the following information.



Observe proper ESD techniques when connecting and disconnecting the DeviceMaster.

- a. Insert the earth ground wire into the chassis ground screw terminal.
Note: *The chassis ground connection is made only if the DIN rail is NOT connected to earth ground.*
- b. Insert the DC positive wire into one of the + screw terminals and the DC return wire into the - screw terminal.

A second redundant power supply can be connected to the unit by inserting the DC positive wire into the other + screw terminal and the DC return wire into the - screw terminal.

The DeviceMaster will continue to operate if one of the two connected power supplies should fail.

If you purchased the Control power supply (separately), the wires are identified below:

- Red = 6-30VDC positive
- White = 6-30VDC return
- Black = chassis ground

If you did not purchase a power supply from Control for the DeviceMaster, see [2-Port \(DB9\) Power Supply](#) on Page 145 for power requirements.

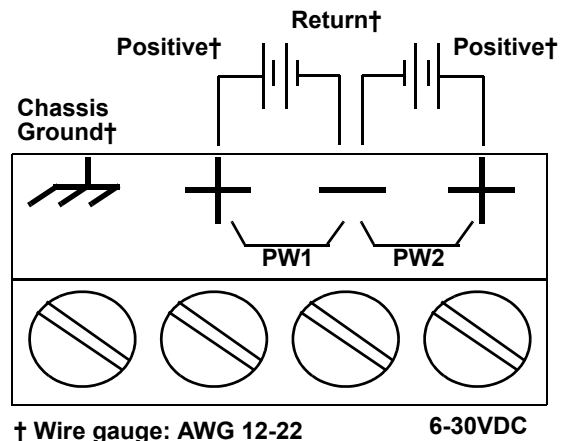

- c. Use a small flat head screw driver to lock the wires into place.
- d. Verify that each wire has been tightened securely.
- e. Connect the power supply to a power source.

Note: *Do not connect multiple units until you have changed the default IP address, see [Initial Configuration](#) on Page 35.*

4. Use the appropriate method for network attachment of your DeviceMaster 2-port:

DeviceMaster 1E: Connect the **10/100 port** to the same Ethernet network segment as the host PC using a standard network cable.

DeviceMaster 2E: Connect the DeviceMaster 2E using one of these methods:

- **Ethernet hub, switch (10/100Base-T), Server NIC (10/100Base-T):** Connect a **10/100 port** to the same Ethernet network segment as the host PC using a standard Ethernet cable.
- **Daisy-chaining DeviceMaster units:** Connect the port labeled **E1** (or **E2**) on the first DeviceMaster to the port labeled **E1** (or **E2**) on the second DeviceMaster or other device using a standard Ethernet cable. Refer to [Daisy-Chaining DeviceMaster 2E/4/8/16-Port Units](#) on Page 173 for more detailed information.

Do not connect RS-422/485 devices until the appropriate port interface type has been configured. The default port setting is RS-232.



Caution

5. Verify that the **Status LED** has completed the boot cycle and network connection for the DeviceMaster is functioning properly using the following table.

2-Port DB9 LED Descriptions	
STATUS	The STATUS LED on the device is lit, indicating you have power and it has completed the boot cycle. <i>Note: The STATUS LED flashes while booting and it takes approximately 15 seconds for the Bootloader to complete the cycle. When the Bootloader completes the cycle, the LED has a solid, steady light that blinks approximately every 10 seconds.</i>
LINK	If the LINK (green) LED is lit, it indicates a working Ethernet connection.
ACT	If the ACT (yellow) LED flashes, it indicates network activity.
<i>Note: For additional LED information, go to the Status LED table on Page 156.</i>	

6. Go to [Initial Configuration](#) on Page 35 for default network settings and how to configure the DeviceMaster for use.

4-Port and 8-Port Installation

Use the following procedure to install the DeviceMaster 4-port or 8-port.

1. Record the MAC address and serial number of the DeviceMaster unit on the customer service label provided.

You may need the MAC address during driver configuration. The MAC address (starts with **00 C0 4E**) and serial number are located on a label on the DeviceMaster.

Note: Do not connect multiple units until you have changed the default IP address, see [Initial Configuration](#) on Page 35.

2. Optionally, attach the mounting brackets using the screws provided in the kit (6-32 1/4" flathead machine) or place the DeviceMaster on a stable surface.



DeviceMaster RTS - Larger Pictures, [Page 151](#)



DeviceMaster PRO and DeviceMaster Serial Hub
Larger Picture, [Page 151](#)



Failure to use the correct screws can damage the PCB and void the warranty. Do NOT use screws that exceed the length of the screws provided with the mounting bracket kit.

Note: If you ordered the DeviceMaster Rackmount Shelf Kit accessory, use the document that accompanied that kit or [download the document](#) to mount the DeviceMaster on the shelf.

3. Connect the DeviceMaster to the same Ethernet network segment as the host PC using one of the following methods:
 - **Ethernet hub or switch (10/100Base-T):** Connect to the port labeled **UP** on the DeviceMaster using a standard Ethernet cable.
 - **Server NIC (10/100Base-T):** Connect to the port labeled **DOWN** on the DeviceMaster using a standard Ethernet cable.
 - **Daisy-chaining DeviceMaster units:** Connect the port labeled **DOWN** on the first DeviceMaster to the port labeled **UP** on the second DeviceMaster or other device using a standard Ethernet cable. Refer to [Daisy-Chaining DeviceMaster 2E/4/8/16-Port Units](#) on Page 173 for more detailed information.



Do not connect RS-422/485 devices until the appropriate port interface type has been configured. The default port setting is RS-232.

4. Apply power to the DeviceMaster by connecting the AC power adapter to the DeviceMaster, the appropriate power cord for your location to the power adapter, and plugging the power cord into a power source. If you want to provide your own power supply, see [4-Port Power Supply](#) on Page 146.

5. Verify that the **PWR** LED has completed the boot cycle and network connection for the DeviceMaster is functioning properly using the table below.

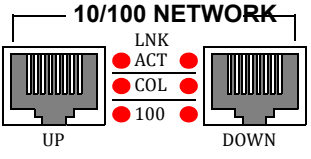
4-Port and 8-Port LED Descriptions	
PWR	LED on the front panel of the DeviceMaster is lit, indicating you have power and it has completed the boot cycle. <i>Note: The PWR LED flashes while booting and it takes approximately 15 seconds for the Bootloader to complete the cycle. When the Bootloader completes the cycle, the LED has a solid, steady light that blinks approximately every 10 seconds.</i>
LNK ACT	The red LNK ACT LED is lit, indicating that you have a working Ethernet connection.
COL	If the red COL LED is lit, there is a network collision.
100	If the red 100 LED is lit, it indicates a working 100 MB Ethernet connection (100 MB network, only). If the LED is not lit, it indicates a 10 MB Ethernet connection.
 <p style="text-align: center;">10/100 NETWORK</p> <p style="text-align: center;">LNK ACT COL 100</p> <p style="text-align: center;">UP DOWN</p>	
<i>Note: For additional LED information, go to the Status LED table on Page 156.</i>	

6. Go to [Initial Configuration](#) on Page 35 for default network settings and how to configure the DeviceMaster for use.

16-Port (DeviceMaster RTS - External Power Supply) Installation

Use the following procedure to install the DeviceMaster RTS 16-port with an external power supply.

1. Record the MAC address and serial number of the DeviceMaster unit on the customer service label provided.

You may need the MAC address during driver configuration. The serial number and MAC address (starts with **00 C0 4E**) are located on a label on the DeviceMaster.

Note: Do not connect multiple units until you have changed the default IP address, see [Initial Configuration](#) on Page 35.

2. Place the DeviceMaster RTS on a stable surface, or *optionally* mount the DeviceMaster in a rack.

Rack Installation:

- a. Attach the L brackets to the interface using the screws supplied with the unit.
- b. You can mount the unit facing in either direction.



Larger picture, [Page 151](#)

- c. Attach the L bracket into your rack.

Follow these guidelines when mounting the DeviceMaster RTS in a rack.



- **If the DeviceMaster is installed in a closed or multi-rack assembly, the operating temperature of the rack environment may be greater than the ambient temperature. Be sure to install the DeviceMaster in an environment that is compatible with the maximum rated ambient temperature.**
 - **Make sure that the mechanical loading is level to avoid a hazardous condition; such as, loading heavy equipment in the rack unevenly. The rack should safely support the combined weight of all equipment in the rack.**
 - **Slots and openings in the cabinet are provided for ventilation. To ensure reliable operation of the DeviceMaster and to protect it from overheating, maintain a minimum of 1 inch of clearance on all sides of the unit.**
 - **AC power inputs are intended to be used with a three-wire grounding type plug, which has a grounding pin. Equipment grounding ensures safe operation. Do not defeat the grounding means and verify that the DeviceMaster is reliably grounded when mounting within the rack.**
3. Connect the DeviceMaster RTS to the same Ethernet network segment as the host PC using one of the following methods.
 - **Ethernet hub or switch (10/100Base-T):** Connect to the port labeled **UP** on the DeviceMaster RTS using a standard Ethernet cable.
 - **Server NIC (10/100Base-T):** Connect to the port labeled **DOWN** on the DeviceMaster RTS using a standard Ethernet cable.
 - **Daisy-chaining DeviceMaster units:** Connect the port labeled **DOWN** on the first DeviceMaster RTS to the port labeled **UP** on the second DeviceMaster or other device using a standard Ethernet cable.



Do not connect RS-422/485 devices until the appropriate port interface type has been configured. The default port setting is RS-232.

4. Apply power to the DeviceMaster RTS by connecting the AC power adapter to the DeviceMaster, the power cord to the power adapter, and plugging the power cord into a power source. See [External Power Supply Specifications](#) on Page 144 if you want to provide your own power supply.
5. Verify that the PWR LED has completed the boot cycle and network connection for the DeviceMaster RTS is functioning properly using the table below.

DeviceMaster RTS 16-Port (External Power Supply) LED Descriptions	
Red LED	<p>Red LED on the front panel of the DeviceMaster is lit, indicating you have power and it has completed the boot cycle.</p> <p>Note: <i>The LED flashes while booting and it takes approximately 15 seconds for the Bootloader to complete the cycle. When the Bootloader completes the cycle, the LED has a solid, steady light that blinks approximately every 10 seconds.</i></p>
LNK ACT	<p>The red LNK ACT LED is lit, indicating that you have a working Ethernet connection.</p>
COL	<p>If the red COL LED is lit, there is a network collision.</p>
100	<p>If the red 100 LED is lit, it indicates a working 100 MB Ethernet connection (100 MB network, only). If the LED is not lit, it indicates a 10 MB Ethernet connection.</p>
<p>Note: For additional LED information, go to the Status LED table on Page 156.</p>	

6. Go to [Initial Configuration](#) on Page 35 for default network settings and how to configure the DeviceMaster for use.

16-Port (DeviceMaster PRO) Installation

Use the following procedure to install the DeviceMaster PRO 16-port with an external power supply.

1. Record the MAC address and serial number of the DeviceMaster unit on the customer service label provided.

You may need the MAC address during driver configuration. The serial number and MAC address are located on a label on the device. The MAC address starts with **00 C0 4E**.

2. Place the DeviceMaster PRO on a stable surface, or *optionally* mount the DeviceMaster PRO in a rack.

Rack Installation:

- a. Attach the L brackets to the DeviceMaster PRO using the screws supplied with the unit.
- b. You can mount the unit facing in either direction.



- c. Attach the L bracket into your rack.

Follow these guidelines when mounting the DeviceMaster in a rack.

- **If the DeviceMaster PRO is installed in a closed or multi-rack assembly, the operating temperature of the rack environment may be greater than the ambient temperature. Be sure to install the DeviceMaster in an environment that is compatible with the maximum rated ambient temperature.**
- **Make sure that the mechanical loading is level to avoid a hazardous condition; such as, loading heavy equipment in the rack unevenly. The rack should safely support the combined weight of all equipment in the rack.**
- **Slots and openings in the cabinet are provided for ventilation. To ensure reliable operation of the DeviceMaster and to protect it from overheating, maintain a minimum of 1 inch of clearance on all sides of the unit.**
- **AC power inputs are intended to be used with a three-wire grounding type plug, which has a grounding pin. Equipment grounding ensures safe operation. Do not defeat the grounding means and verify that the DeviceMaster is reliably grounded when mounting within the rack.**

3. Connect the DeviceMaster PRO to the same Ethernet network segment as the host PC using one of the following methods.

- **Ethernet hub or switch (10/100Base-T):** Connect to the port labeled **UP** on the DeviceMaster PRO using a standard Ethernet cable.
- **Server NIC (10/100Base-T):** Connect to the port labeled **DOWN** on the DeviceMaster PRO using a standard Ethernet cable.
- **Daisy-chaining DeviceMaster units:** Connect the port labeled **DOWN** on the first DeviceMaster PRO to the port labeled **UP** on the second DeviceMaster PRO or other device using a standard Ethernet cable.

Note: Do not connect multiple units until you have changed the default IP address, see [Initial Configuration](#) on Page 35.





Caution

If you plan on using the NS-Link device driver, make sure that you do not connect RS-422/485 devices until the appropriate port interface type has been configured in the driver. The NS-Link default port setting is RS-232.

4. Connect the power cord into a power source.
5. Apply power to the DeviceMaster PRO by turning on the power switch.
6. Verify that the PWR LED has completed the boot cycle and network connection for the DeviceMaster is functioning properly using the table below.

DeviceMaster PRO 16-Port LED Description	
Red LED (Front panel)	<p>Red LED on the front panel of the DeviceMaster PRO is lit, indicating you have power and it has completed the boot cycle.</p> <p>Note: <i>The LED flashes while booting and it takes approximately 15 seconds for the Bootloader to complete the cycle. When the Bootloader completes the cycle, the LED has a solid, steady light that blinks approximately every 10 seconds.</i></p>
LNK/ACT	<p>The red LNK/ACT LED is lit, indicating that you have a working Ethernet connection.</p>
COL	<p>If the red COL LED is lit, there is a network collision.</p>
100	<p>If the red 100 LED is lit, it indicates a working 100 MB Ethernet connection (100 MB network, only). If the LED is not lit, it indicates a 10 MB Ethernet connection.</p>
<p>Note: For additional LED information, go to the Status LED table on Page 156.</p>	

7. Go to [Initial Configuration](#) on Page 35 for default network settings and how to configure the DeviceMaster for use.

16/32-Port Rack Mount Models (Internal Power Supply) Installation

Use the following procedure to install the DeviceMaster 16-port or 32-port with an internal power supply.

1. Record the MAC address and serial number of the DeviceMaster unit on the customer service label provided.

You may need the MAC address during driver configuration. The serial number and MAC address (starts with 00 C0 4E) are located on a label on the DeviceMaster.

Note: Do not connect multiple units until you have changed the default IP address, see [Initial Configuration](#) on Page 35.

2. Place the DeviceMaster on a stable surface, or *optionally* mount the DeviceMaster in a rack.

Rack Installation:

- a. Attach the L brackets to the interface using the screws supplied with the unit.



- b. You can mount the unit facing in either direction.
- c. Attach the L bracket into your rack.

Follow these guidelines when mounting the DeviceMaster in a rack.

- ***If the DeviceMaster is installed in a closed or multi-rack assembly, the operating temperature of the rack environment may be greater than the ambient temperature. Be sure to install the DeviceMaster in an environment that is compatible with the maximum rated ambient temperature.***
- ***Make sure that the mechanical loading is level to avoid a hazardous condition; such as, loading heavy equipment in the rack unevenly. The rack should safely support the combined weight of all equipment in the rack.***
- ***Slots and openings in the cabinet are provided for ventilation. To ensure reliable operation of the DeviceMaster and to protect it from overheating, maintain a minimum of 1 inch of clearance on all sides of the unit.***
- ***AC power inputs are intended to be used with a three-wire grounding type plug, which has a grounding pin. Equipment grounding ensures safe operation. Do not defeat the grounding means and verify that the DeviceMaster is reliably grounded when mounting within the rack.***



Caution

- Connect the DeviceMaster port labeled **10/100 NETWORK** to the same Ethernet network segment as the host PC using a standard network cable.

DeviceMaster RTS - Larger pictures, [Page 152](#)



DeviceMaster Serial Hub - Larger picture, [Page 151](#)



If you plan on using the NS-Link device driver, make sure that you do not connect RS-422/485 devices until the appropriate port interface type has been configured in the driver. The NS-Link default port setting is RS-232.

- Apply power to the DeviceMaster by connecting the appropriate power cord into the power socket on the DeviceMaster, plugging the power cord into a power source, and turning on the power switch.
- Verify that the **Status** LED has completed the boot cycle and network connection for the DeviceMaster is functioning properly using the table below.

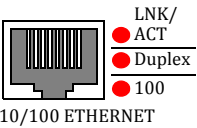
16/32-Port (Internal Power Supply) LED Descriptions	
Status	The amber Status LED on the device is lit, indicating you have power and it has completed the boot cycle. Note: <i>The Status LED flashes while booting and it takes approximately 15 seconds for the Bootloader to complete the cycle. When the Bootloader completes the cycle, the LED has a solid, steady light that blinks approximately every 10 seconds. For additional LED information, go to the Status LED table on Page 156.</i>
LNK/ACT	The red LNK/ACT LED is lit, indicating that you have a working Ethernet connection.
Duplex	If the red Duplex LED is lit, it indicates full-duplex activity.
100	If the red 100 LED is lit, it indicates a working 100 MB Ethernet connection (100 MB network, only). If the LED is not lit, it indicates a 10 MB Ethernet connection.
	
Note: <i>The port LED activity may be inconsistent until the port has been opened. After a port is opened, LED activity works as documented.</i>	

- Go to [Initial Configuration](#) on Page 35 for default network settings and how to configure the DeviceMaster for use.

Initial Configuration

There are several ways to configure network information. Control Technical Support recommends connecting the DeviceMaster to a PC or laptop running Windows and installing *PortVision DX* for initial configuration.

Optionally, you can use RedBoot to configure the network address and upload SocketServer, see [RedBoot Procedures](#) on Page 133.

This section shows how to use PortVision DX for initial DeviceMaster configuration. It also defines requirements and how configuring DeviceMaster security affects PortVision DX and shows you how to:

- Install PortVision DX
- Configure the network address ([Page 40](#))
- Check the SocketServer version on the DeviceMaster ([Page 43](#))
- If necessary, download the latest version SocketServer and upload it into the DeviceMaster ([Page 45](#))
- Modbus Server, only load Modbus Server if you want a Modbus Server-only environment ([Page 47](#))
- Organize how PortVision DX displays your Control Ethernet attached products
- Access the latest documentation for your Control Ethernet attached product

PortVision Plus

PortVision DX replaces PortVision Plus. PortVision Plus does not support:

- Operating systems above Windows 7
- SocketServer versions v9.00 or above
- NS-Link device driver v10.xx or above

PortVision DX Overview

PortVision DX automatically detects Control Ethernet attached products physically attached to the local network segment so that you can configure the network address, upload firmware, and manage the following products:

- DeviceMaster family
 - DeviceMaster PRO
 - DeviceMaster RTS
 - DeviceMaster Serial Hub
 - DeviceMaster UP
 - DeviceMaster 500
- IO-Link Master
- RocketLinx switches

In addition to identifying Control Ethernet attached products, you can use PortVision DX to display any third-party switch and hardware that may be connected directly to those devices. All non-Control products and unmanaged

RocketLinx switches are treated as non-intelligent devices and have limited feature support. For example, you cannot configure or update firmware on a third-party switch.

PortVision DX Requirements

Use PortVision DX to identify, configure, update, and manage the DeviceMaster on the following Windows operating systems:

- Windows 8
- Windows Server 2012
- Windows 7
- Windows Server 2008
- Windows Vista
- Windows Server 2003
- Windows XP

PortVision DX requires that you connect the Control Ethernet attached product to the same network segment as the Windows host system if you want to be able to scan and locate it automatically during the configuration process.

Configuring Security Settings and PortVision DX

The following list provides basic PortVision DX operations that are affected how the DeviceMaster interacts with PortVision DX when security is enabled using the web interface (SocketServer/NS-Link).

- PortVision DX must scan the DeviceMaster before configuring security.
- PortVision DX locates the DeviceMaster before setting either **Secure Data Mode** or **Secure Config Mode**.
- If PortVision DX discovers the DeviceMaster after setting security, the following conditions occur:
 - The IP address of the DeviceMaster does not display.
 - The *Software Settings* and *Web Interface* tabs are not present in the *Properties* page.
 - The IP mode displays as DHCP without the ability to modify.
 - The **Upload** and **Reboot** icons on the *Launch Bar* are grayed out and the options are disabled in the popup menus.

Note: *If the DeviceMaster was previously configured with security, PortVision DX features are reduced.*

Installing PortVision DX

During initial configuration, PortVision DX automatically detects and identifies DeviceMaster units, if they are in the same network segment.

Use the *Software and Documentation* CD that came with the DeviceMaster to check for the latest version of PortVision DX or use the link below to download the latest version.

1. Locate PortVision DX using one of the following methods to download the latest version:
 - **Software and Documentation CD:** You can use the CD menu system to check the version on the CD against the latest released version.
 - **FTP site subdirectory:**
ftp://ftp.control.com/dev_mstr/portvision_dx.

Note: Depending on your operating system, you may need to respond to a Security Warning to permit access.

2. Execute the **PortVision_DX[version].msi** file.
3. Click **Next** on the *Welcome* screen.

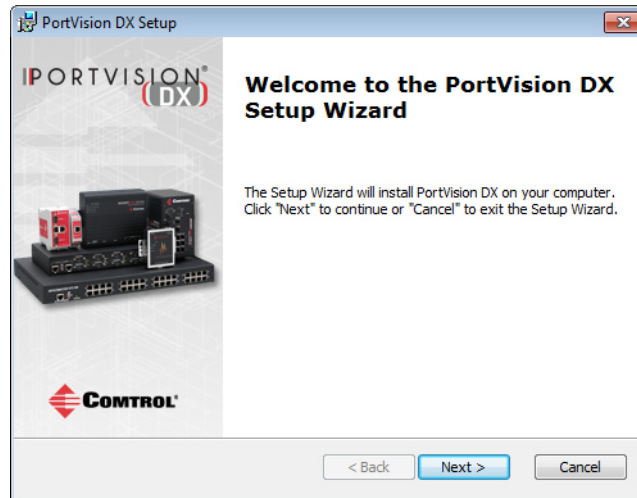

4. Click **I accept the terms in the License Agreement** and **Next**.

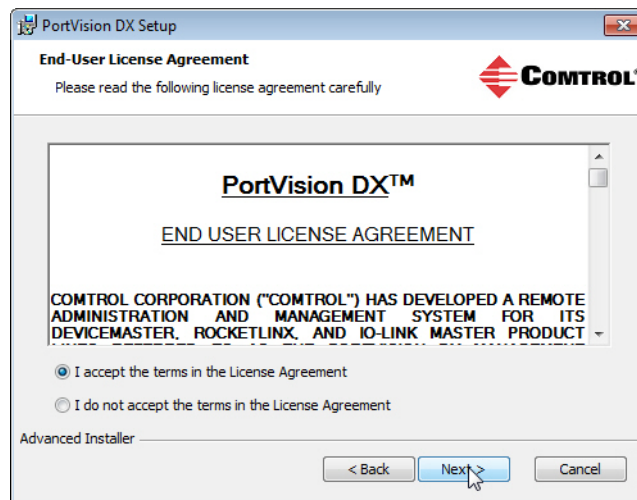

5. Click **Next** or optionally, browse to a different location and then click **Next**.

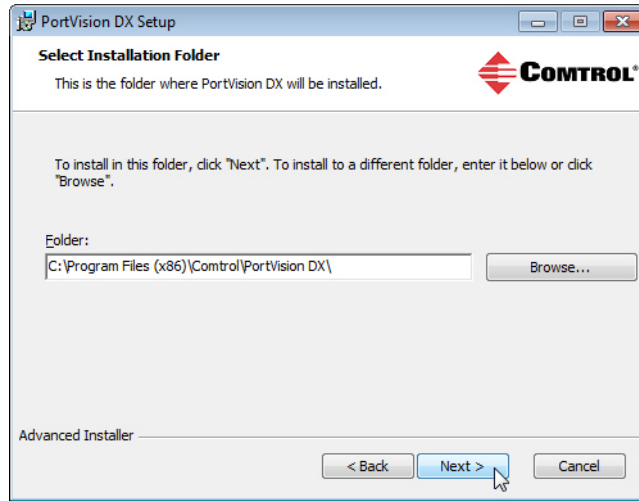

6. Click **Next** to configure the shortcuts.

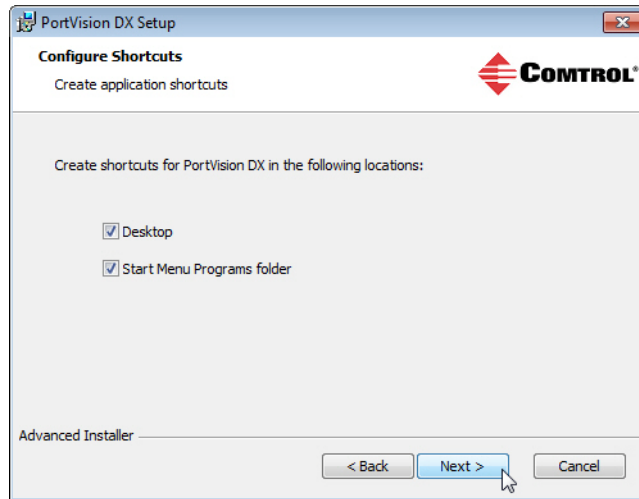

7. Click **Install**.

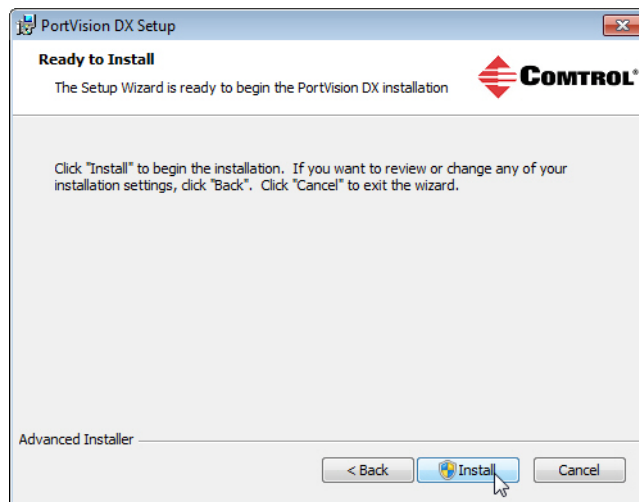

8. Depending on the operating system, you may need to click **Yes** to the *Do you want to allow the following program to install software on this computer?* query.
9. Click **Launch PortVision DX** and **Finish** in the last installation screen.

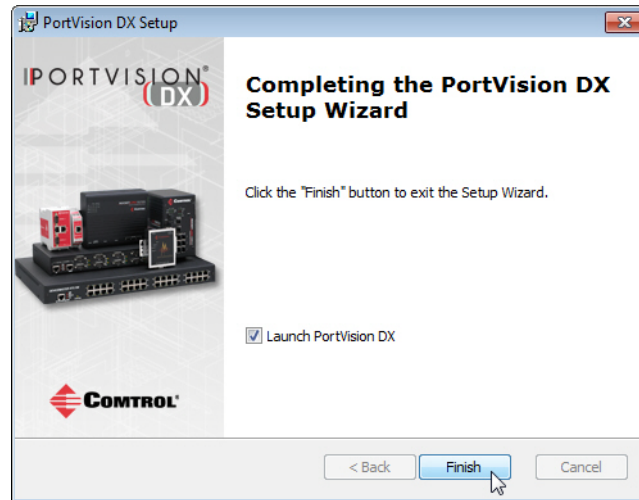

10. Depending on the operating system, you may need to click **Yes** to the *Do you want to allow the following program to make changes to this computer?* query.
11. Select the Control Ethernet attached products that you want to locate and then click **Scan**.

You can save time if you only scan for DeviceMasters.

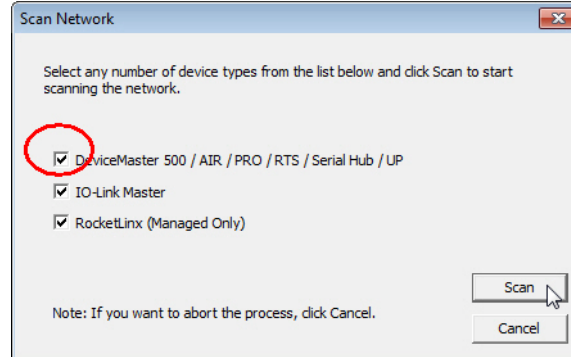

Note: *If the Control Ethernet attached product is not on the local segment and it has been programmed with an IP address, it will be necessary to manually add the Control Ethernet attached product to PortVision DX.*

12. Go to [Step 5](#) in the next section, *Configuring the Network Settings*, to program the DeviceMaster network settings.

If you need additional information about PortVision DX, refer to the **Help** system.

Configuring the Network Settings

Use the following procedure to change the default network settings on the DeviceMaster for your network.

Default Network Settings

IP address:
192.168.250.250

Subnet mask:
255.255.0.0

Gateway address:
192.168.250.1

Note: *Technical Support advises configuring one new DeviceMaster at a time to avoid device driver configuration problems. If you want to configure multiple DeviceMasters using the **Assign IP to Multiple Devices** option, see [Configuring Multiple DeviceMasters Network Addresses](#) on Page 115.*

The following procedure shows how to configure a single DeviceMaster connected to the same network segment as the Windows system. If the DeviceMaster is not on the same physical segment, you can add it manually using [Adding a New Device](#) on Page 115.

1. If you have not done so, install PortVision DX ([Installing PortVision DX](#) on Page 37).
2. Start PortVision DX using the **PortVision DX** desktop shortcut or from the **Start** button, click **Programs > Control > PortVision DX > PortVision DX**.
3. Depending on your operating system, you may need to click **Yes** to the *Do you want to allow the following program to make changes to this computer?* query.
4. Click **Scan** to locate the Control Ethernet attached products including the DeviceMaster on the network.

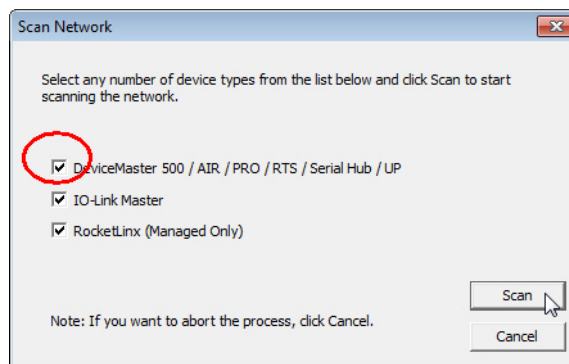

Note: *If you do not have any RocketLinx managed switches or IO-Link Masters, it saves scanning time if you do not scan for them.*

5. Highlight the DeviceMaster for which you want to program network information and open the **Properties** screen using one of these methods.
 - Double-click the DeviceMaster in the *Device Tree* or *Device List* pane.
 - Highlight the DeviceMaster in the *Device Tree* or *Device List* pane and click the **Properties** button.
 - Right-click the DeviceMaster in the *Device Tree* or *Device List* pane and click **Properties** in the popup menu
 - Highlight the DeviceMaster, click the **Manage** menu and then **Properties**.

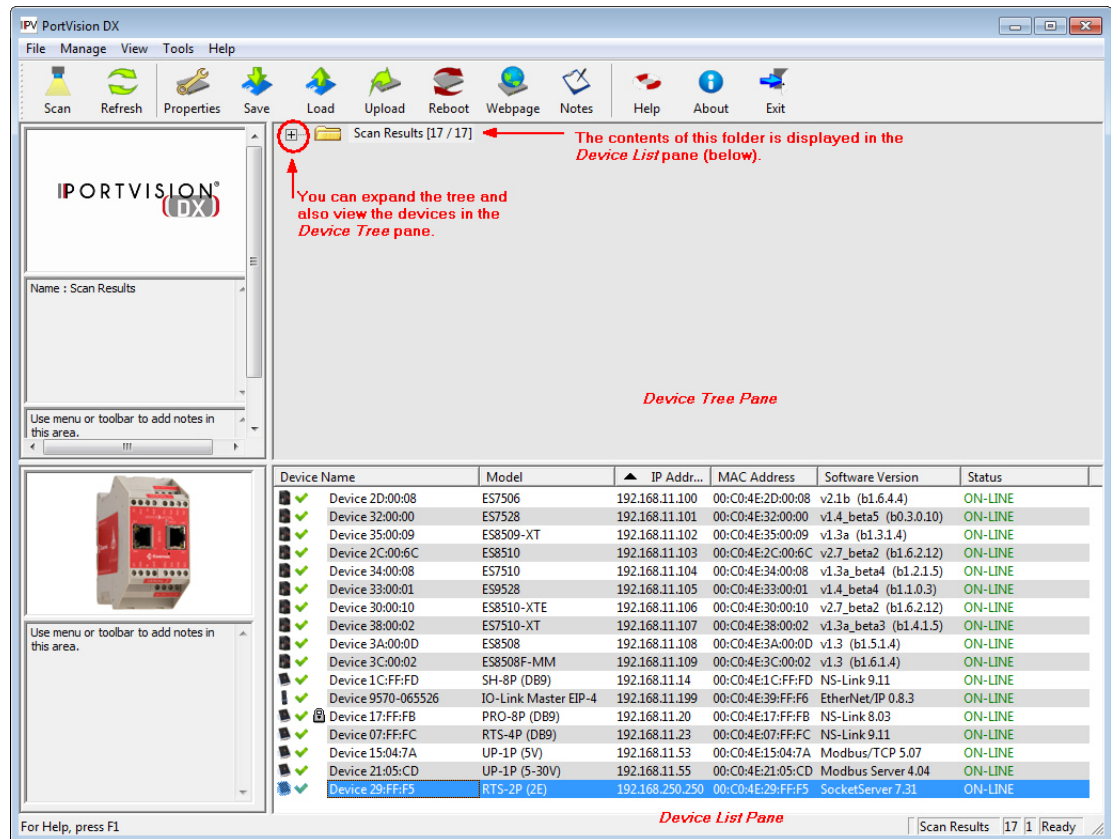

6. *Optionally*, rename the DeviceMaster in the **Device Name** field.

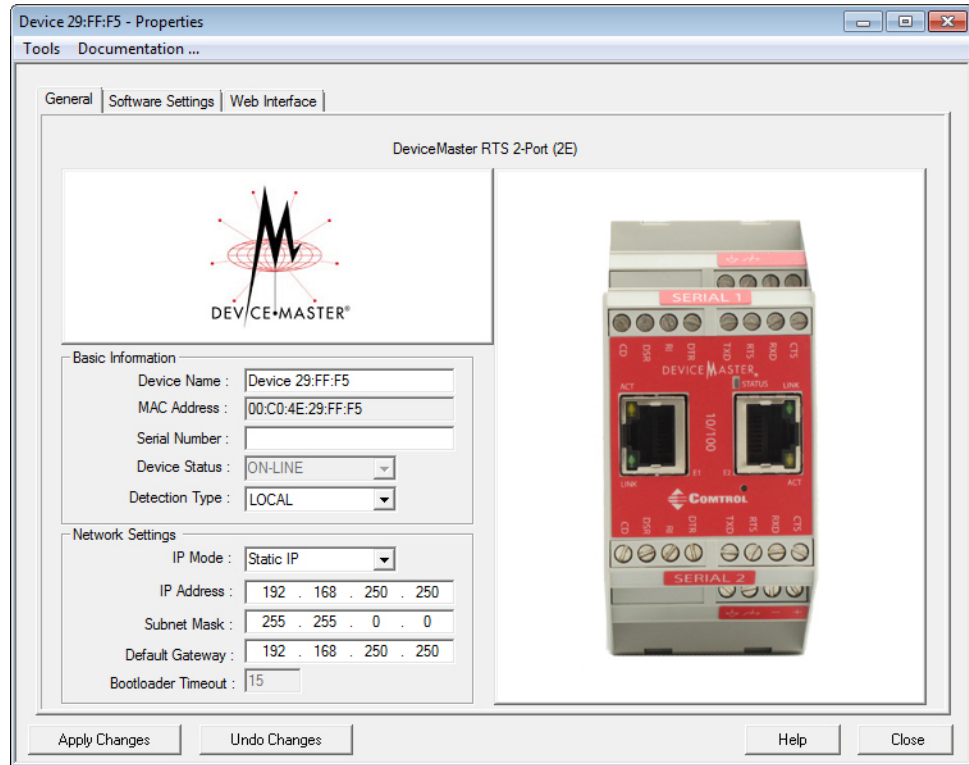

Note: *SocketServer versions previous to v9.00 did not support the Bootloader Timeout option in the PortVision DX **Properties** screen as shown in the above screen shot.*

Note: *The MAC address Device Status fields are automatically populated and you cannot change those values.*

7. *Optionally*, enter the serial number, which is on a label on the DeviceMaster.
8. If necessary, you can change the Detection Type.
 - **REMOTE** means that the DeviceMaster is not connected to this segment of the network and it uses IP communications, not MAC communications.
 - **LOCAL** means that the DeviceMaster is on this local network segment and uses MAC communications. An IP address is not required but Technical support recommends using an IP address.
9. Change the DeviceMaster network properties as required for your site.
 - If you want to disable IP communications on the DeviceMaster, click **Disable IP**.
 - To use the DeviceMaster with DHCP, click **DHCP IP**, and make sure that you provide the MAC address of the device to the network administrator. Make sure that the administrator reserves the IP address, subnet mask and gateway address of the DeviceMaster in the DHCP server.
 - To program a static IP address, click **Static IP** and enter the appropriate values for your site.

Note: *For additional information, open the PortVision DX Help system.*

10. Typically, the **Bootloader Timeout** value should be left to its default value. In some situations, you may need to temporarily adjust the **Bootloader Timeout** to a higher value during a firmware update.

11. Click **Apply Changes** to update the network information on the DeviceMaster.

Note: *If you are deploying multiple DeviceMasters that share common values, you can save the configuration file and load that configuration onto other DeviceMasters. See [Using SocketServer Configuration Files](#) on Page 117 for more information.*
12. Click **Close** to exit the *Properties* window.
13. Go to [Checking the SocketServer Version](#) on Page 43 to check the SocketServer version. You should update SocketServer firmware before any further configuration, unless you are planning on installing Modbus Server.

Checking the SocketServer Version

[SocketServer](#) refers to the web page that is integrated in the firmware that comes pre-installed on your DeviceMaster platform, which provides an interface to TCP/IP socket mode configuration and services. If you install an NS-Link device driver, an NS-Link version of SocketServer loads on the DeviceMaster.

Control recommends verifying that your DeviceMaster contains the latest SocketServer version before any further configuration to avoid installation problems.

Note: *Technical Supports recommends that you update to the latest version of SocketServer before installing an NS-Link device driver or configuring socket ports.*

Use the following procedure to check the SocketServer version on the DeviceMaster and check the ftp site for the latest version.

1. If necessary, open **PortVision DX > Start/Programs > Control > PortVision DX > PortVision DX** or use the desktop shortcut and scan the network.
2. Check the SocketServer version number of the *Software Version* for the DeviceMaster.

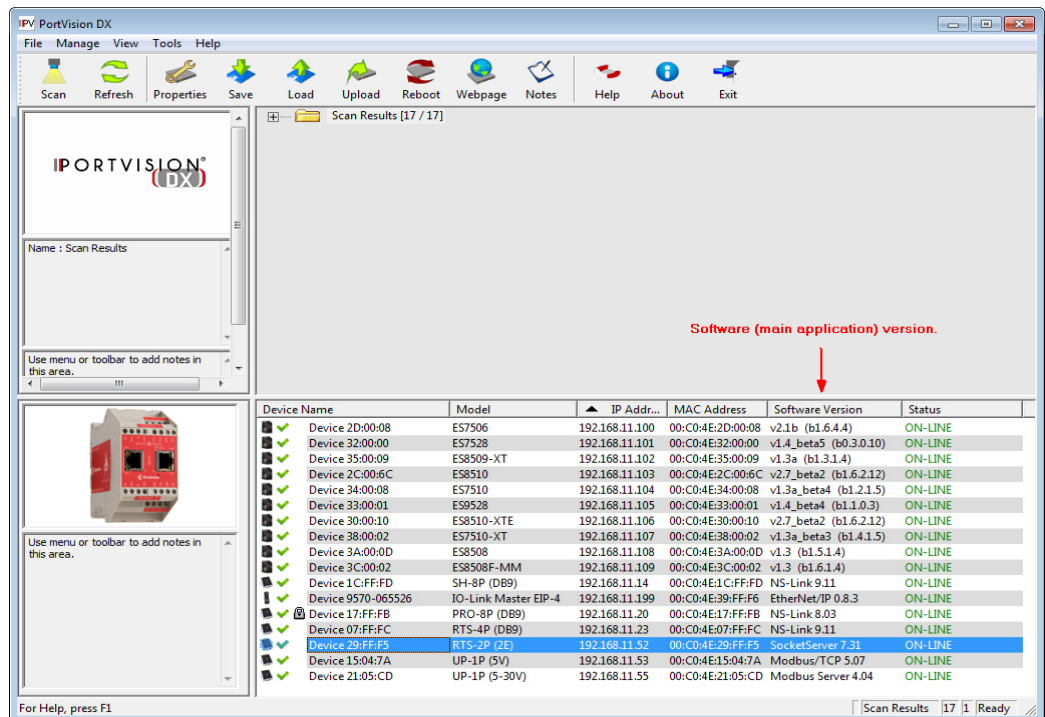

3. Check the Control ftp site to see if a later version is available using one of these methods:
 - Access an [ftp download page](#) for DeviceMaster, which provides links and notices for the latest SocketServer version.
 - View an ftp subdirectory that contains the latest version of SocketServer: ftp://ftp.control.com/dev_mstr/rts/software/socketserver.

FTP directory /dev_mstr/rts/software/socketserver/ at ftp.control.com

To view this FTP site in Windows Explorer, click **Page**, and then click **Open FTP Site in Windows Explorer**.

[Up to higher level directory](#)

03/11/2013 02:16PM	124,405	1800111_socketserver_history.pdf
02/08/2013 10:42AM	Directory	help
10/02/2012 10:08AM	1,174,340	socketserver-8.04.bin

Note: *The DeviceMaster PRO, DeviceMaster RTS, DeviceMaster Serial Hub, and DeviceMaster 500 all use the same firmware, although the above paths point to the location of the DeviceMaster RTS file.*

4. If the version on the web site is later than the version on the DeviceMaster, download the file, and then go to [Uploading SocketServer with PortVision DX](#) on Page 45.

If the SocketServer version on the DeviceMaster is current, you are ready to continue the installation and configuration process.

Uploading SocketServer with PortVision DX

Use this section to upload a newer version of [SocketServer](#) on the DeviceMaster using PortVision DX. Technical Support recommends updating SocketServer before any further configuration to avoid configuration problems.

You can use this procedure if your DeviceMaster is connected to the host PC, laptop, or if the DeviceMaster resides on the local network segment.

If the DeviceMaster is on the other side of several switches, a router, or wireless, go to [Updating Firmware Across WANs \(Windows\)](#) on Page 108, which provides more reliable uploads.

1. Make sure that you have downloaded the latest SocketServer version from: ftp://ftp.control.com/dev_mstr/rts/software/socketserver.

Note: Depending on your operating system, you may need to respond to a Security Warning popup.

2. If necessary, open **PortVision DX > Start/Programs > Control > PortVision DX > PortVision DX** or use the desktop shortcut.
3. Right-click the DeviceMaster or DeviceMasters for which you want to update, click **Advanced > Upload Firmware**, browse to the SocketServer .bin file, and then click **Open**.

Optionally, you can highlight the DeviceMaster and click the Upload button in the Launch bar.

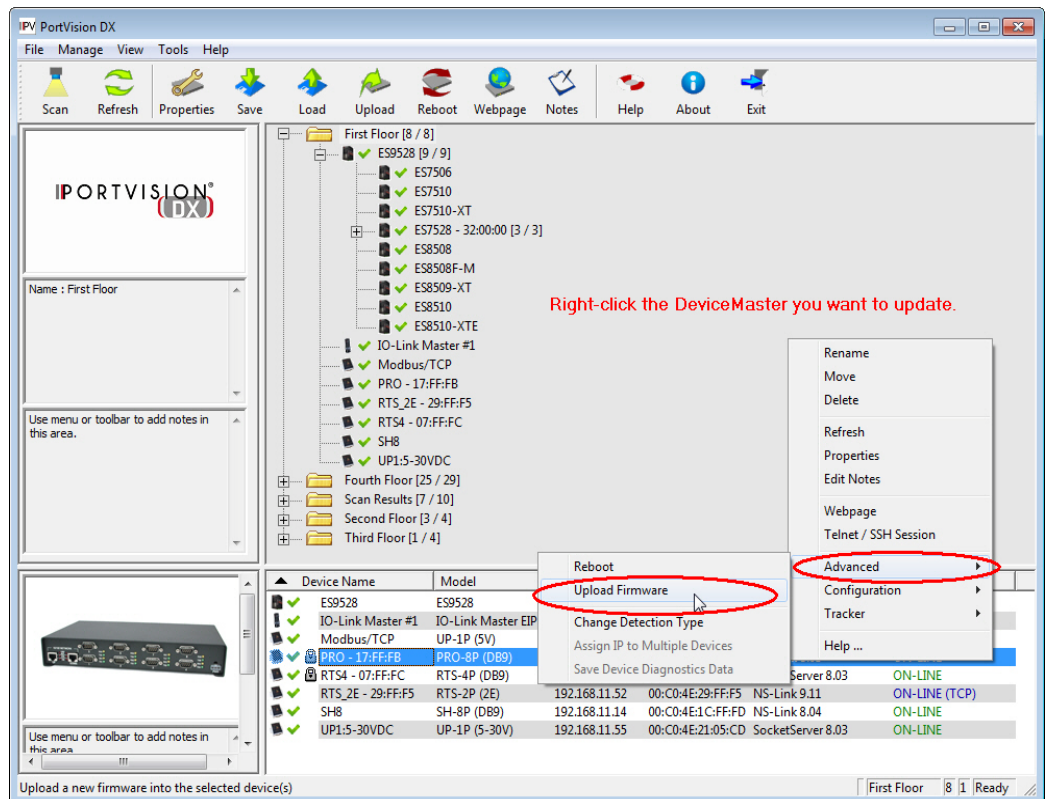

Note: If the Detection Type is set to REMOTE, you may want to change it to LOCAL. The DeviceMaster Status on a DeviceMaster that is set to REMOTE displays in blue: **ON-LINE (TCP)**.

4. Click **Yes** to the *Upload Firmware* message that warns you that this is a sensitive process. It may take a few moments for the firmware to upload onto the DeviceMaster. The DeviceMaster reboots itself during the upload process.

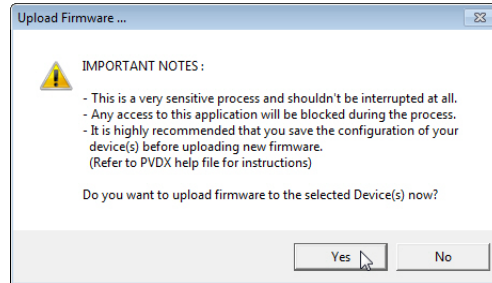

5. Click **Ok** to the advisory message about waiting to use the device until the status reads **ON-LINE**. In the next polling cycle, PortVision DX updates the *Device List* pane and displays the new SocketServer version or right-click the DeviceMaster and click **Refresh**.
6. If the upload fails, reset the Bootloader timeout to 60 seconds and then repeat [Steps 3](#) through 5. For procedures, see [Changing the Bootloader Timeout](#) on Page 124.

You are now ready to continue the installation and configuration process.

- [Device Driver \(NS-Link\) Installation](#) on Page 53
- [Socket Port Configuration](#) on Page 67

Uploading Modbus Server

Use this section to upload Modbus Server firmware on the DeviceMaster using PortVision DX.

Note: Only load the Modbus Server firmware if you want exclusively Modbus Server ports on the DeviceMaster. For more information about Modbus Server, see [Modbus Server Application Overview](#) on Page 91.

1. Make sure that you have located or downloaded the [latest Modbus Server](#) firmware.
2. Execute the **Modbus_Server.msi** file and follow the file wizard.
3. Start PortVision DX using the **PortVision DX** desktop shortcut or from the Start button, click **Programs > Control > PortVision DX > PortVision DX**.
4. Right-click the DeviceMaster for which you want to update, click **Advanced > Upload Firmware**, browse to the **Modbus_Server.bin** file, and then click **Open**.

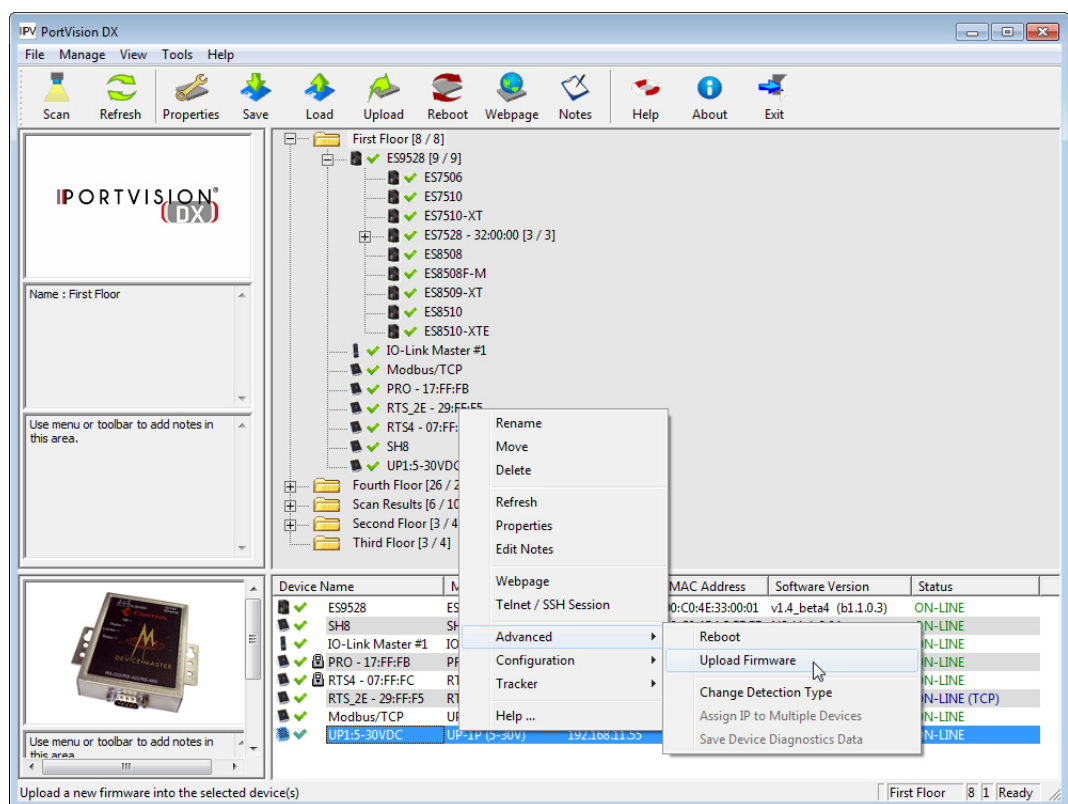

Note: The **Modbus_Server.bin** was placed in the **Control/Modbus_Server** directory on your system unless you changed the file location in the installation wizard.

5. Click **Yes** to the *Upload Firmware* message that warns you that this is a sensitive process.

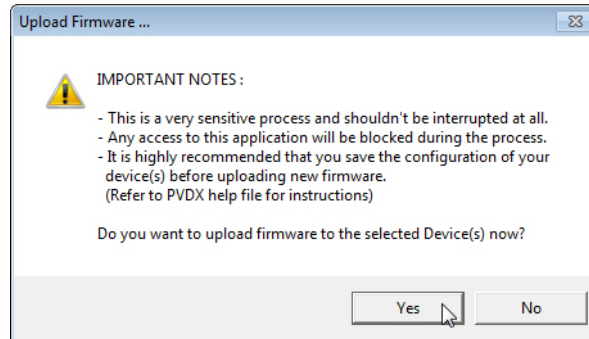

It may take a few moments for the firmware to upload onto the device. The device will reboot itself during the upload process.

6. Click **Ok** to the advisory message about waiting to use the device until the status reads **ON-LINE**. In the next polling cycle, PortVision DX updates the *Device List* pane and displays the Modbus Server version.

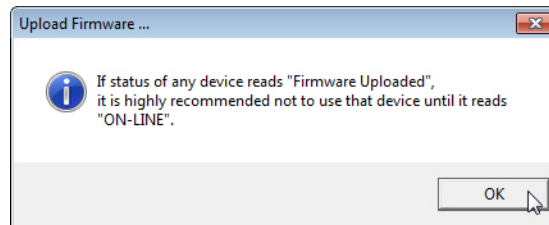

Use the [DeviceMaster Modbus Server User Guide](#) to configure the DeviceMaster ports.

Customizing PortVision DX

You can customize how PortVision DX displays the devices. You can even create sessions tailored for specific audiences. You can also add shortcuts to other applications using **Tools > Applications > Customize** feature.

The following illustrates how you can customize your view.

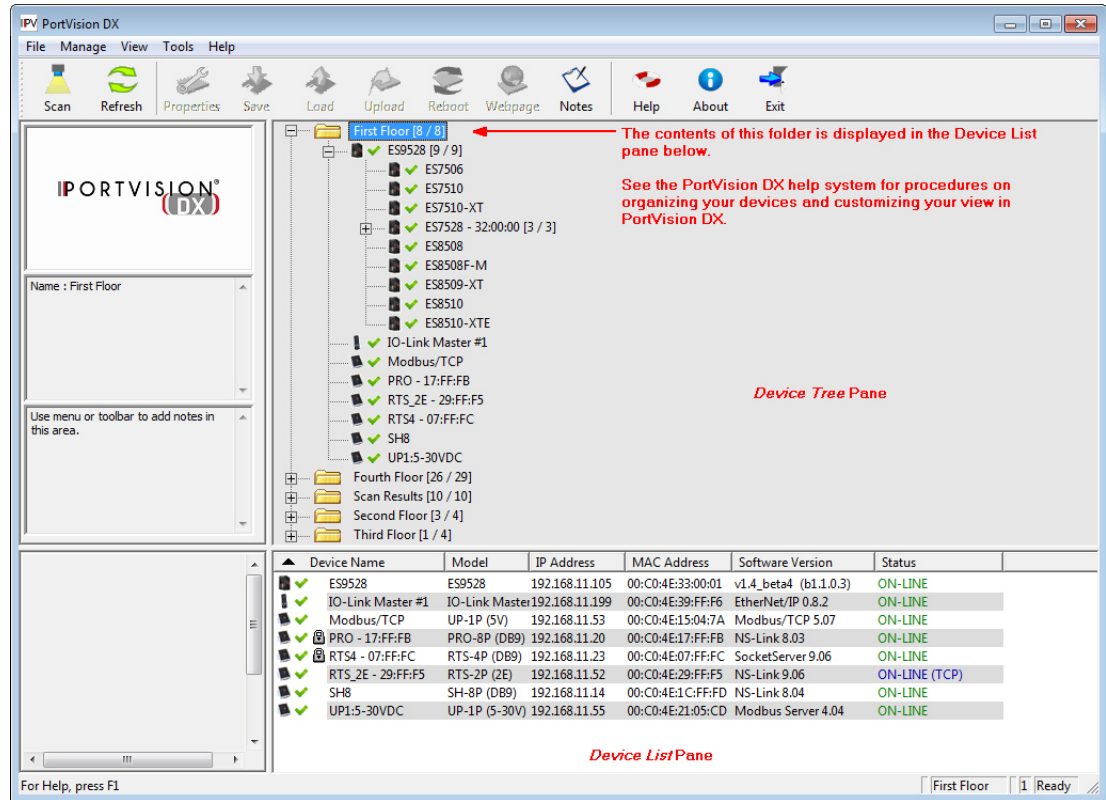

See the PortVision DX Help system for detailed information about modifying the view. For example, the above screen shot illustrates devices layered in folders.

Accessing DeviceMaster Documentation from PortVision DX

You can use this procedure in PortVision DX to [download](#) and [open the previously downloaded documents](#) for the DeviceMaster. You can also check to see if you have the latest version of the documentation using PortVision DX.

How to Download Documentation

Use this procedure to initially download a document or documents.

1. If necessary, open **PortVision DX > Start/Programs > Control > PortVision DX > PortVision DX** or use the desktop shortcut.
2. Click **Help > Documentation**.
3. Optionally, click the **DOWNLOAD THE CURRENT DOCUMENTATION CATALOG ONLINE** button to make sure that the latest documentation is available to PortVision DX.

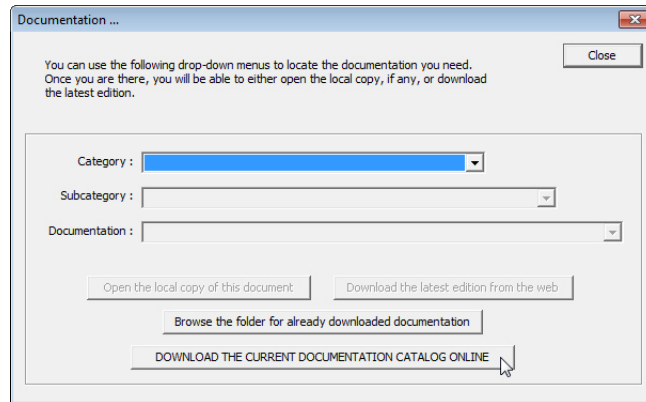
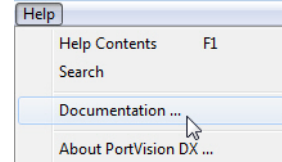

4. Select the product **Category** from the drop list.
5. Select the document you want to download from the **Documentation** drop list.
6. Click the **Download the latest edition from the web** button.

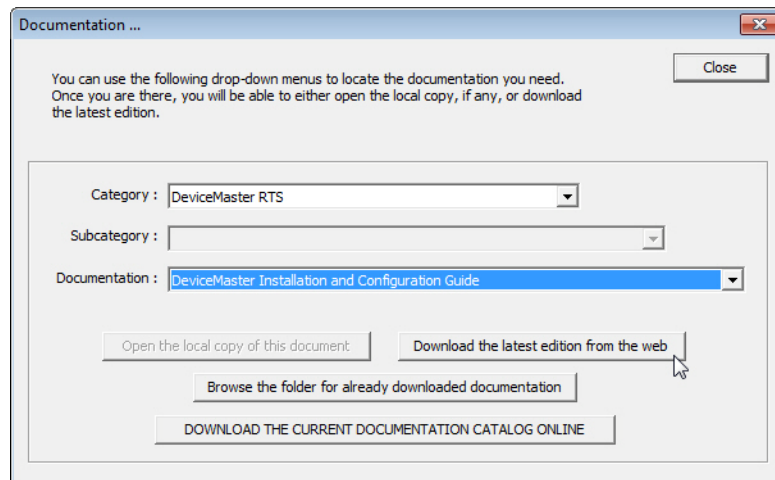

Note: It may take a few minutes to download, depending on your connection speed. The document opens automatically after it has downloaded.

7. Click **Close** if you have downloaded all of the documents that you wanted.

How to Open Previously Downloaded Documents

Use the following procedure to access previously downloaded documents in PortVision DX.

Note: *Optionally, you can browse to the **Program Files (x86) > Control > PortVision DX > Docs** subdirectory and open the document.*

1. If necessary, open **PortVision DX > Start/Programs > Control > PortVision DX > PortVision DX** or use the desktop shortcut.
2. Click **Help > Documentation**.
3. Click the **Open the local copy of the document** button to view the document.

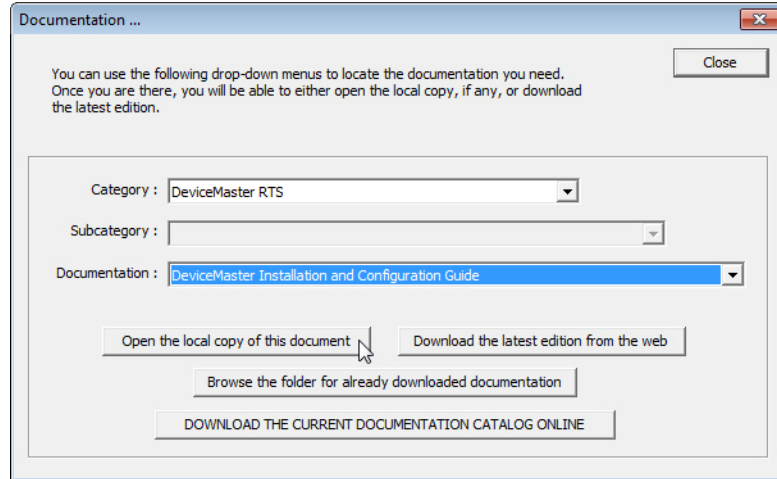

Note: *If the document fails to open, it may be that your browser has been disabled. You can still access the document by clicking the **Browse the folder for already downloaded documentation** button and opening the document with your custom browser.*

4. Click **Close** in the *Documentation...* popup, unless you want to open or download other documents.

Device Driver (NS-Link) Installation

This section discusses the following topics:

- [Linux Installations](#) on Page 55
- [Windows Installations](#) on Page 56

Overview

The following subsections discuss procedures that need to be done before installing and configuring the NS-Link device driver.

Before Installing the NS-Link Driver

Before installing the NS-Link device driver for the Linux and Windows operating systems, the following conditions must be met:

- The DeviceMaster is connected to the network and powered on ([Hardware Installation](#) on Page 15).
- The network information has been configured in the DeviceMaster ([Configuring the Network Settings](#) on Page 40).
- Checked to see if the latest version of SocketServer resides on the DeviceMaster ([Checking the SocketServer Version](#) on Page 43 using PortVision DX or you can open your browser, enter the DeviceMaster IP address to view the version on the *Server Status* page (formerly the *Server Configuration* in SocketServer versions previous to 9.02).
- If necessary, uploaded the latest version of SocketServer ([Uploading SocketServer with PortVision DX](#) on Page 45 or you can use RedBoot, [Uploading Firmware - Telnet Method \(Linux\)](#) on Page 138).

Note: *Technical Supports recommends that you update to the latest version of SocketServer before installing any NS-Link device driver.*

After NS-Link driver installation and configuration, the same ports can be configured as TCP/IP sockets using an NS-Link version of the SocketServer web page ([Socket Port Configuration](#) on Page 67).

Existing Installations

This subsection discusses issues that may affect an existing installation.

- [Drivers \(Windows\) before v10.xx](#) on Page 54
- [Drivers \(Linux\) before 5.00](#) on Page 54

Previous NS-Link drivers (Windows and Linux) and SocketServer v8.00, were released as two versions of firmware that ran on the DeviceMaster (SocketServer and NS-Link).

Recent changes in the NS-Link drivers have incorporated the firmware into a single binary (.bin) file. By default, once loaded, SocketServer shows in the web page until the NS-Link device driver begins communication with this particular DeviceMaster.

Once a driver establishes communications, the firmware indicates that it is NS-Link. The driver does not need to upload firmware to the DeviceMaster or reboot the DeviceMaster.

If SocketServer does not change to NS-Link in the web page then the NS-Link device driver loaded in the PC/laptop is NOT communicating with the DeviceMaster.

*Drivers (Windows)
before v10.xx*

When upgrading NS-Link drivers for Windows, you must remove the existing driver and re-install the latest driver. In addition, you must update the Bootloader to v3.23 or higher.

If you are unsure about the driver version, refer to the device driver help system, which provides the procedure on how to check a driver version.

You can use this procedure to upgrade from driver version before v10.xx.

1. Optionally, you can save your existing NS-Link device and COM port configuration to a device driver configuration file that you can upload to the DeviceMaster and to individual ports after installing the 10.xx driver. See [Saving Driver Configuration Files](#) on Page 119 to save the driver configuration settings.
2. Remove the existing NS-Link driver.
Note: You can refer to the *Control Drivers Management Console help system* or the [DeviceMaster NS-Link Device Driver User Guide for Windows](#), if you need detailed driver removal or installation procedures.
3. Make sure that you reboot the system as prompted after the driver removal.
4. Upload the latest version of SocketServer. You can refer to [Uploading SocketServer with PortVision DX](#) on Page 45 for these procedures.
5. Upload the latest version of Bootloader. You can refer to [Uploading Bootloader](#) on Page 128 for procedures.
6. Install the latest NS-Link driver by executing the `DeviceMaster_Windows_x.xx.exe` file and following the installation wizard.
7. Associate the MAC address to the DeviceMaster and if required, configure IP mode. Refer to [Configuring the NS-Link Driver for Windows](#) on Page 60 for the procedure to associate the MAC address.
8. Configure the device properties ([Configuring the NS-Link Driver for Windows](#) on Page 60) or optionally, upload the device properties from the driver configuration file ([Loading Device Configuration](#) on Page 120).
9. Configure the port properties ([Configuring COM Port Properties for Windows](#) on Page 64) or optionally, upload the COM port properties port-by-port ([Loading Port Configuration](#) on Page 122). The port properties must be uploaded on each port.

*Drivers (Linux)
before 5.00*

Previous to the NS-Link Linux driver v5.00 and SocketServer v8.00, there were two versions of firmware that ran on the DeviceMaster, SocketServer and NS-Link.

With the release of v5.00 of the NS-Link driver for Linux, SocketServer and NS-Link have been incorporated into a single binary (.bin) file.

By default, once loaded, SocketServer shows in the web page until the NS-Link device driver begins communication with this particular DeviceMaster.

Once a driver establishes communications, the firmware indicates that it is NS-Link. The driver does not need to upload firmware to the DeviceMaster or reboot the DeviceMaster.

If SocketServer does not change to NS-Link in the web page then the NS-Link device driver loaded in the PC/laptop is NOT communicating with the DeviceMaster.

Note: Control recommends uploading the latest version of SocketServer before configuring the driver or sockets.

Linux Installations

You can locate the latest device driver for Linux using one of these methods:

- **Download the latest device driver:** ftp://ftp.comtrol.com/dev_mstr/rts/drivers/linux.

Note: Although the ftp link displays rts in the path, the driver supports the DeviceMaster models discussed in this User Guide.

- **Software and Documentation CD:** You can use the CD to check the driver version on the CD against the latest released version. Open the `/html/default.htm` file to use the menu system, which provides you with links to download all software and documents.

Refer to the **README** file packaged with the Linux driver for driver installation and configuration procedures.

Before you install the Linux NS-Link device driver:

1. Make sure that you have programmed an appropriate network address into the DeviceMaster. If you do not want to install PortVision DX on a Windows system, you can use RedBoot, which is discussed in [Configuring the Network Settings](#) on Page 136.
2. Make sure that you verify that you have the latest version of SocketServer loaded on the DeviceMaster.

If you do not want to install PortVision DX (Page 37) to check the SocketServer version, you can:

- a. Open SocketServer to check the version by opening your browser and entering the IP address of the DeviceMaster.

Note: Following images show the difference between SocketServer v9.xx and previous versions.

The image displays two screenshots of the DeviceMaster web interface. Both screenshots feature the 'CONTROL Network Enabling Devices' logo at the top. The left screenshot shows the 'Server Configuration' page with a table of settings. The 'Software' field is circled in red and contains 'SocketServer 7.31'. Below the table are links for 'Configure Network', 'Configure Security', 'Configure Email Messages', and 'Configure RFC1006 (ISO over TCP)'. The right screenshot shows the 'Server Status' page with a list of system parameters. The 'Software' field is circled in red and contains 'SocketServer 9.11'. Below the status information is a 'Connection Status' section with four port indicators (Port 1, Port 2, Port 3, Port 4).

Server Configuration	
Software:	SocketServer 7.31
IP Config:	Static
IP Address:	192.168.11.52
IP Netmask:	255.255.0.0
IP Gateway:	192.168.1.254
Configure Network	
Configure Security	
Configure Email Messages	
Configure RFC1006 (ISO over TCP)	

Server Status	
Software:	SocketServer 9.11
Host Name:	
IPv4 Config:	Static
IPv4 Address:	192.168.11.23
IPv4 Netmask:	255.255.0.0
IPv4 Gateway:	192.168.11.1
IPv6 Config:	Disabled
IPv6 Address:	ffff:ffff:ffff:ffff:ffff:ffff:ffff:ffff/255
IPv6 Gateway:	ffff:ffff:ffff:ffff:ffff:ffff:ffff:ffff

- b. Check the ftp site for the latest version: ftp://ftp.comtrol.com/dev_mstr/rts/software/SocketServer.
- c. If necessary, download the latest version. If you do not want to use PortVision DX, use RedBoot to upload the latest version of SocketServer, which is discussed in [Uploading Firmware - Telnet Method \(Linux\)](#) on Page 138.

Note: Technical Supports recommends that you update to the latest version of SocketServer before installing an NS-Link device driver.

3. Install and configure the Linux device driver using the **Readme** file packaged with the driver.

Windows Installations

This subsection provides an installation overview for the NS-Link device driver for Windows. For detailed installation and configuration information, see the [DeviceMaster Device Driver \(NS-Link\) User Guide for Windows](#), which is available on the *Software and Documentation* CD or you can [download](#) the latest.

Supported Operating Systems

The NS-Link device driver for Windows supports:

- Windows 8
- Windows Server 2012
- Windows 7
- Windows Server 2008
- Windows Vista
- Windows Server 2003
- Window XP

If you are updating the driver or need to remove the NS-Link device driver, you can refer to the [DeviceMaster Device Driver \(NS-Link\) User Guide](#) or the help system.

Note: *Administrative privileges are required to install device drivers on Windows systems (excluding Windows Server 2003 and Windows XP).*

Installation Overview for Windows

The following NS-Link device driver installation and configuration procedures are discussed in this subsection:

- Install the NS-Link device driver and *Control Drivers Management Console* using the *Installation Wizard*.
- Configure the COM ports using the *Control Drivers Management Console*.
- Configure device properties using the *Control Drivers Management Console*.

NS-Link for Windows Installation

1. If necessary, locate the NS-Link device driver and make it available to the host system. The driver assembly is available on the *Software and Documentation* CD if you do not have internet access, or download the latest driver from:

ftp://ftp.comtrol.com/dev_mstr/rts/drivers/win7.

Note: *Although the ftp link displays win7 in the path, the driver supports the previously listed [Windows operating systems](#).*

2. Execute the driver assembly **DeviceMaster_Windows_x.xx.exe** file and click **Next** to start the installation.



- Click **Next** to install in the default location.

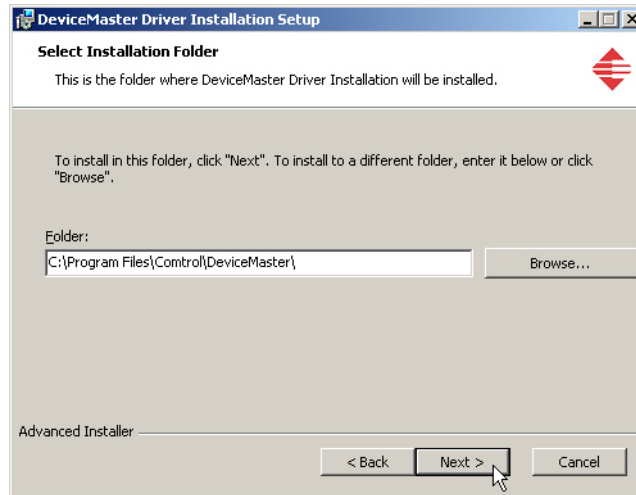

- Click **Install**

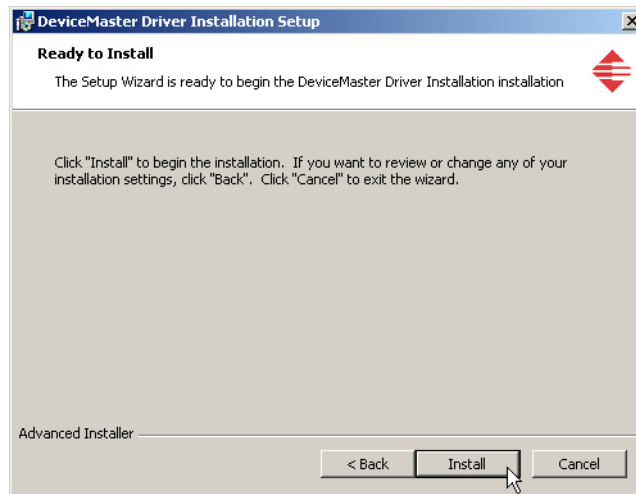

- Leave the **Launch DeviceMaster Driver Installation** box checked.

If you do not check this box, you can use the shortcut under the **Start** button at:
Programs > Control > DeviceMaster > DeviceMaster Driver Installation Wizard.

- Click **Finish** to complete the installation of the wizard.



7. Click **Next** to start the driver installation.



8. Click **Install** and **Next**.



- Select the DeviceMaster model that you are installing from the list.



- Enter the quantity of this DeviceMaster model that you want to install and click **Ok**.

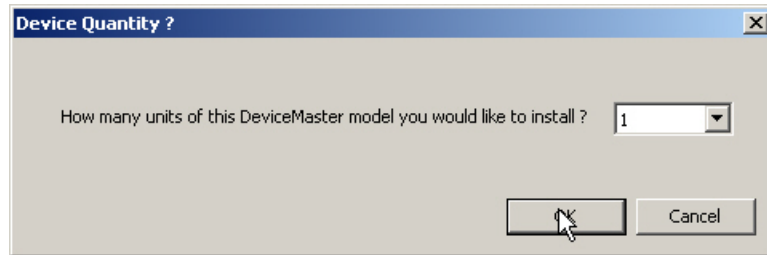

- Repeat Steps 9 and 10 for each DeviceMaster that you are installing and click **Next**.
- Click **Proceed**.

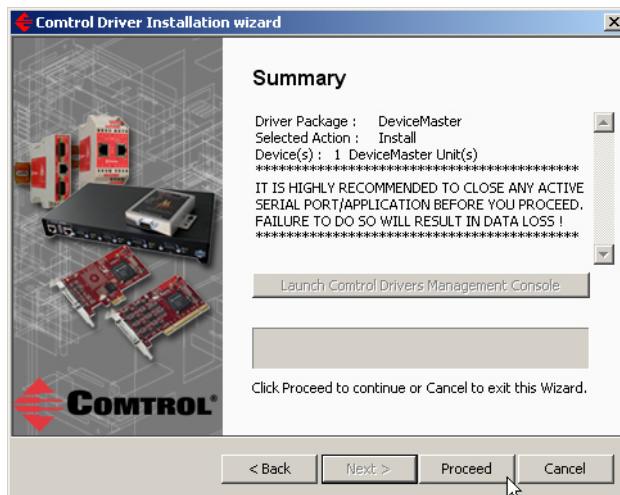

You may see the popup at the right for each port.



13. Return to the *Installation Wizard* and click **Close**.

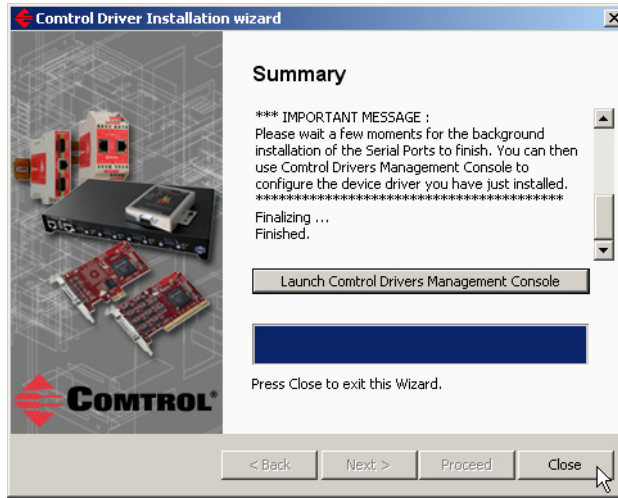

14. Go to the next subsection for NS-Link driver configuration procedures.

Configuring the NS-Link Driver for Windows

This subsection provides a configuration overview for the NS-Link driver. For detailed information or if the DeviceMaster is on a different physical segment, refer to the help system or the *DeviceMaster Device Driver (NS-Link) User Guide*, which is available on the *Software and Documentation* CD or you can [download the latest](#).

The DeviceMaster must be connected to the local network segment or directly to a NIC on the host system to operate in MAC mode to perform the following

configuration steps.

1. Access the *Control Drivers Management Console* using the desktop shortcut or **Start > Programs > Control > DeviceMaster > DeviceMaster Driver Management Console**.
2. Highlight the *Device Name* of the DeviceMaster that you want to configure.

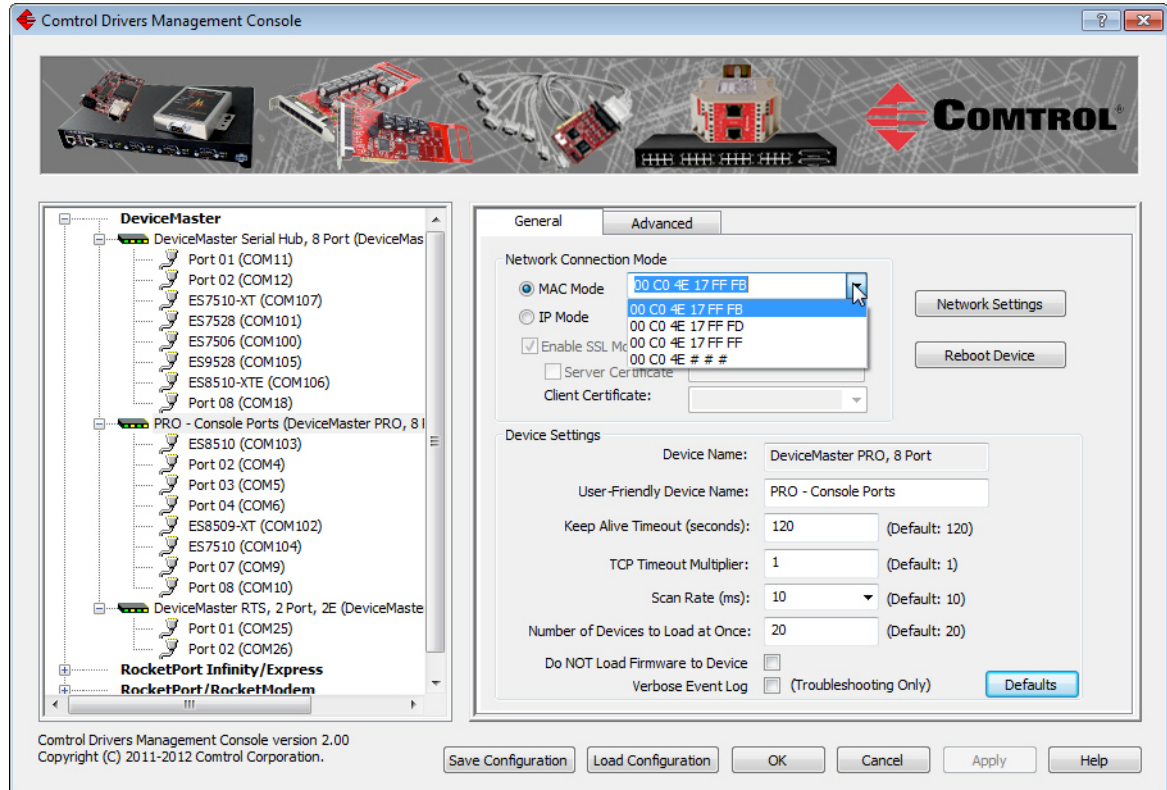

3. Select the MAC address from the drop-down list or enter the address from the MAC address label on the DeviceMaster. If you programmed the IP address using PortVision DX, the IP address displays in the **IP Mode** text box after you select the MAC address.

Note: If you enter the MAC address, make sure that you use the correct format: **00 C0 4E xx xx xx**. A space must separate each pair of digits. The MAC address is located on a label on the DeviceMaster or you can view it using PortVision DX.

If the appropriate MAC address is not displayed in the drop-down list, then it can be one of the following reasons:

- Not on the same network segment
 - DeviceMaster not powered on or connected
 - The wrong model DeviceMaster was selected during the driver installation
 - Device failure
4. Click **Apply** to program the driver with the MAC address of the DeviceMaster or **Ok** to save the change and close the *Control Drivers Management Console*.

If you do not **Apply** the changes before leaving this screen, you will be prompted to **Apply**, **Ignore**, or **Cancel** the changes.

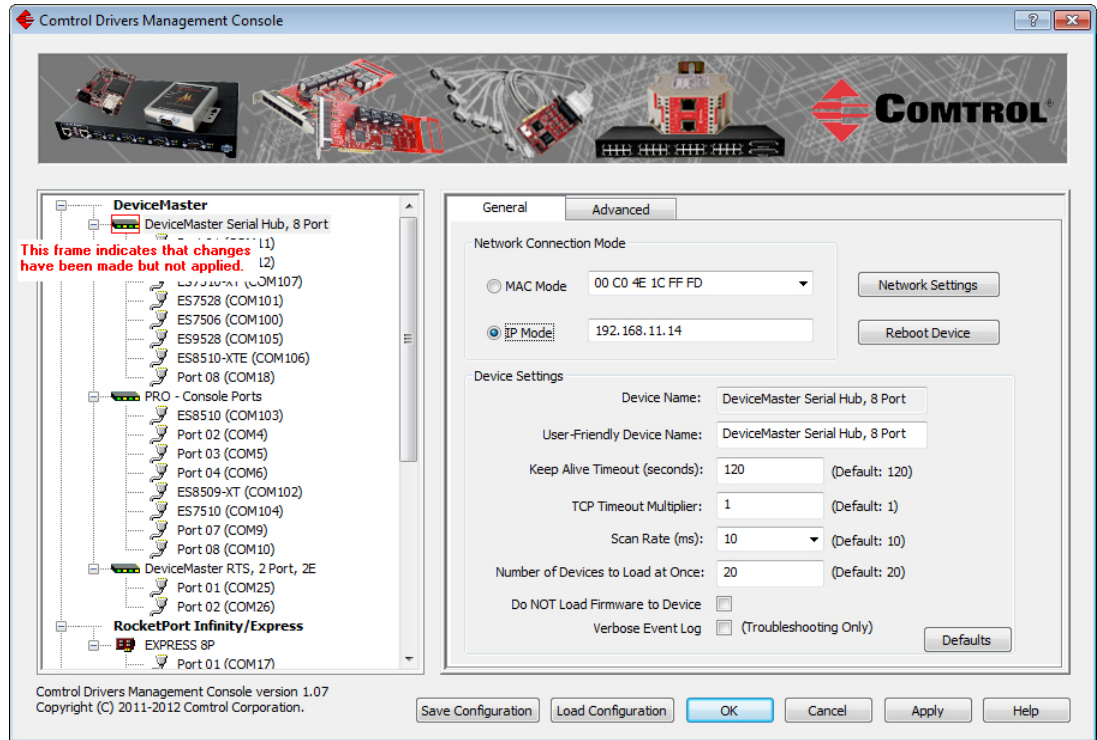

5. Now that the MAC address has been associated to the DeviceMaster, you can use the **Network Settings** screen to:

- Change the IP address, set the DeviceMaster to DHCP, or Disable IP communications using the **Network Settings** button
- Reboot the DeviceMaster on the **General** tab
- Access network statistics on the **Advanced** tab

If you want use **IP mode** and the IP address is configured for your network, click the **IP Mode** radio button and click **Apply**. If you want to use **SSL Mode**, you must set the DeviceMaster to IP mode.

Click the **Network Settings** button and click **Modify** to make any network settings changes.

6. Optionally, click **Enable SSL Mode** if you want to configure secure COM ports.

The DeviceMaster must be configured using IP Mode before you can **Enable SSL Mode**.

If SSL Mode is enabled, TCP connections that carry data to/from the serial ports are encrypted using SSL or TLS security protocols. This includes the following:

- TCP connections to the per-serial-port TCP ports (default is 8000, 8001, 8002, ...) are encrypted using SSL/TLS.
- TCP connections to TCP port 4606 on which the DeviceMaster implements the Control proprietary serial driver protocol are encrypted using SSL/TLS.
- Since SSL/TLS can not be used for either UDP data streams or for the Control proprietary MAC mode Ethernet driver protocol, both UDP and MAC mode serial data transport features are disabled.

In addition to encrypting the data streams, it is possible to configure the DeviceMaster so that only authorized client applications can connect using SSL/TLS.

For this option to function, you must also [Enable Secure Data Mode](#) in the NS-Link web page.

Note: See the help system or the [DeviceMaster NS-Link User Guide for Windows](#) if you need additional information on SSL and the corresponding options.

7. If you are using a server certificate, click the **Server Certificate** check box and enter the name in the **Server Certificate** text box.
 8. If you are using a client certificate, click the drop list and browse to the appropriate client certificate file.
 9. Configure the device properties:
 - a. If desired, change the **User-Friendly Device Name**.
 - b. Optionally, set a different **Keep Alive Timeout** period. You can set the amount of time in seconds that this DeviceMaster waits until it closes this connection and frees all the ports associated with it.
 - c. Optionally, set the **TCP Timeout Multiplier** value.
 - d. Optionally, click a different **Scan Rate (ms)**.
 - e. Optionally, change the **Number of Devices to Load at Once**.
 - f. If necessary, click **Do NOT Attempt to Load Firmware in Device**.
 - g. Optionally, click **Verbose Event Log** if you want to log additional DeviceMaster information into the event log.
 - h. After making your changes, click **Apply** if you have additional configuration procedures or click **Ok** if you have completed configuring your DeviceMaster.
- Note:** You can refer to the help system if you need information about any of the options or features.
10. Optionally, you can click the **Advanced** tab and verify that the *Device Status* message indicates that the DeviceMaster is active and *Ok*.
 11. Go to the next subsection to configure COM port properties.

Configuring COM Port Properties for Windows

The following is a COM port properties configuration overview. Use the [DeviceMaster Device Driver \(NS-Link\) User Guide](#) (also available on the CD) or the NS-Link **Help** system for detailed configuration information.

1. Highlight the first port you want to configure.

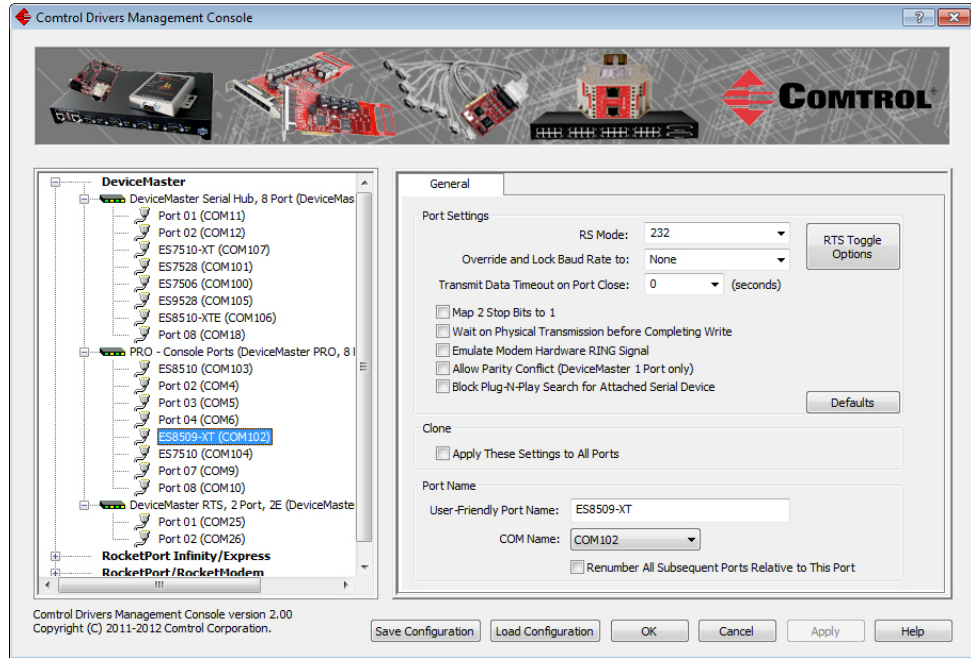

2. Complete the screen appropriately for the serial device that you plan on connecting to the port and click **Ok**.

- a. Select the appropriate communications mode.
- b. Enable the features that you want to use.
- c. Optionally, click the **RTS Toggle Options** button:

- If your communications application does not toggle FTS when transmitting in RS-485 mode.
- If you are using an external RS-232 to RS-485 converter, which is attached to a port that is configured for RS-232.

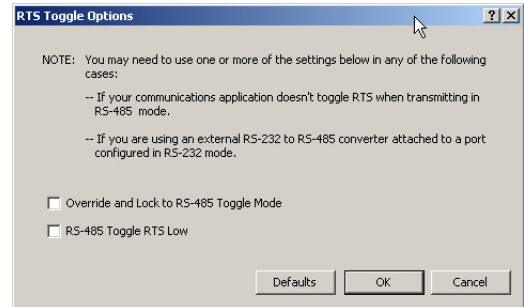

- d. Click the appropriate options for your environment.
 - e. Click **OK** to save the changes and return to the port **General** tab.
3. If desired, click the **Clone** check box to set all of the ports on this DeviceMaster to these characteristics.
 4. Optionally, change the **User-Friendly Port Name**.
 5. If desired, select a different **COM Name** (COM port number). The drop-down list displays (in use) next to COM port numbers that are already in use in this system. Do not duplicate COM port numbers as this will cause the ports to not function.

6. Click **Apply** to save these changes.
*Note: If you selected RS-422 mode, make sure that there is not a device attached to the port and click **Ok**.*
7. Highlight the next port that you want to configure and perform [Steps 1](#) through 6.
8. Refer to [Connecting Serial Devices](#) on Page 95 to attach your serial device.
9. Optionally, you may need to configure one or more ports for socket mode ([Socket Port Configuration](#) on Page 67).

Enabling Secure Data Mode

In addition to enabling SSL mode in the driver, you must **Enable Secure Data Mode** in the NS-Link web page. Use the following procedure to implement the **Enable Secure Data Mode** option.

1. Access the NS-Link web page using one of these methods:
 - Open your web browser, enter the IP address, and press **Enter**.
 - Right-click the DeviceMaster in the *Device List* pane in PortVision DX and click **Webpage**.
2. Click the **Security** tab.
3. Click **Enable Secure Data Mode** and **Save**.

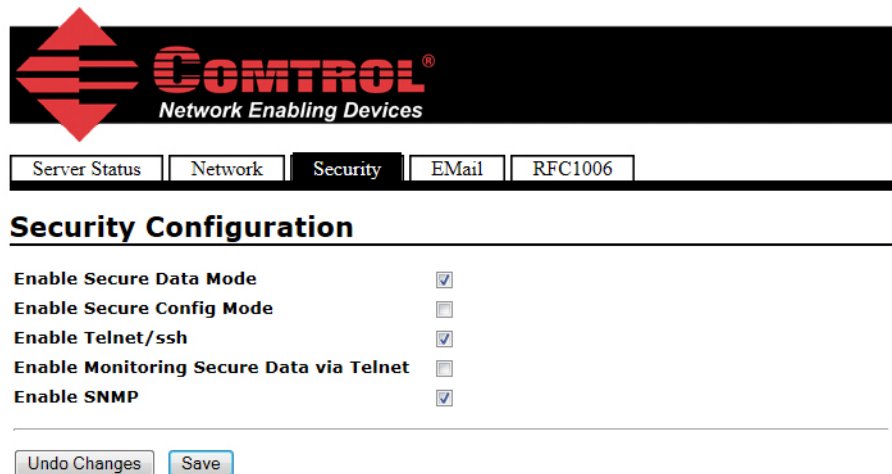

4. Configure your security key and certificate and click **Set**.

Key and Certificate Management

RSA Key pair used by SSL and SSH servers	factory	Set	Delete
RSA Server Certificate used by SSL servers	factory	Set	Delete
DH Key pair used by SSL servers	factory	Set	Delete
Client Authentication Certificate used by SSL servers	none	Set	Delete

Click the **Help** button if you need information about key and certificate management.

Socket Port Configuration

This section provides an overview of SocketServer and provides basic operating procedures. SocketServer and DeviceMaster security are discussed in detail in [DeviceMaster Security](#) on Page 71.

Note: *Technical Supports recommends that you update to the latest version of SocketServer before installing an NS-Link device driver or configuring socket ports.*

SocketServer Overview

SocketServer is the name of the TCP/IP socket web page that is integrated in the firmware that comes pre-installed on your DeviceMaster. When you install an [NS-Link device driver](#), an NS-Link version of SocketServer loads on the DeviceMaster.

The SocketServer home page (*Server Status*) provides access to configure.

Note: *The procedures and illustrations in this subsection support SocketServer v9.xx and higher. If you are using a SocketServer version less than v9.xx, you may want to refer to the [Revision D of this guide](#).*

- Socket port characteristics for:

- Serial
- TCP connection
- UDP connection

See [SocketServer Architecture](#) on Page 68 for more information about socket port support.

- Network settings (after initial configuration)
- [Security](#), which is discussed in detail starting on Page 71
- Email notification services
- RFC1006 (ISO over TCP)

Note: *For socket service configuration procedures or detailed information each field, see the web page [Help system](#).*

Web Page Help System

The web page *Help* system is available separately for your convenience. The web page Help system contains detailed information and configuration procedures for each mode discussed in [SocketServer Architecture](#) on Page 68.

The *Help* system for the web page is available on the CD on the *Supporting Documents* page for your DeviceMaster or you can download the latest version from: ftp://ftp.control.com/dev_mstr/rtts/software/socketserver/help/ssvr_help.zip.

To use the help system:

1. Unzip the files in a folder.
2. Open the **ssvr_help.htm** file.
3. Use your browser find function to locate the option or information for which are searching.

SocketServer Architecture

TCP/IP socket mode operation is used to connect serial devices with an application that supports TCP/IP socket communications addressing.

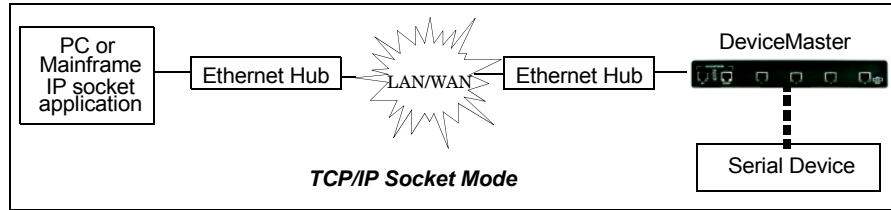

Serial tunneling mode is used to establish a socket connection between two DeviceMasters through an ethernet network.

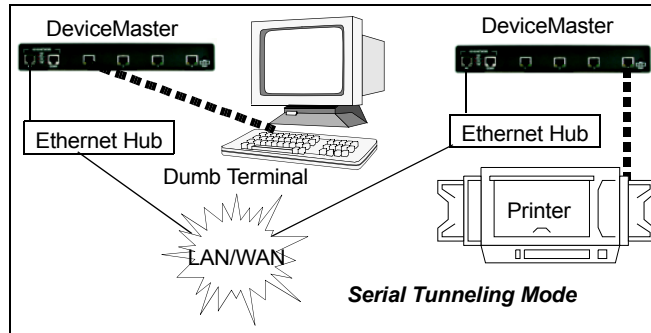

UDP mode is designed for applications that need faster data transmission, or that make use of UDP's broadcast capabilities. UDP differs from TCP in that a UDP transmission does not first require a connection to be opened before sending data and the receiving device does not issue acknowledgements to the sender.

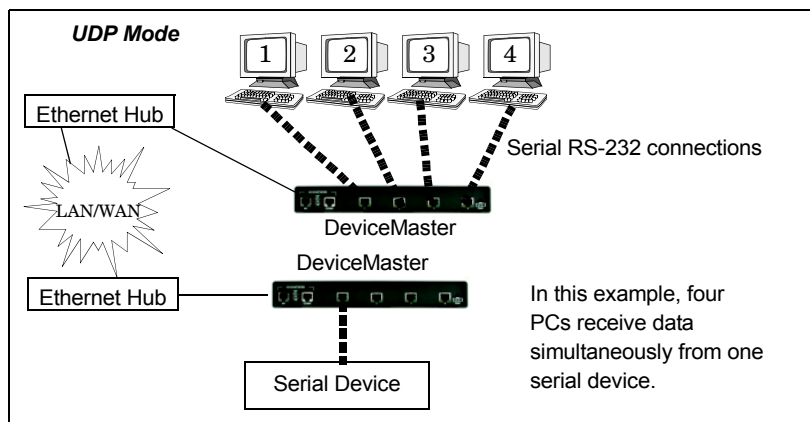

Accessing Socket Configuration

There are several ways to access the socket configuration pages (either version, SocketServer or NS-Link). Use the method that fits your environment best.

- *Web Browser*
- *PortVision DX*

Web Browser

To access the socket configuration page for the DeviceMaster using a web browser, follow this procedure.

1. Start your web browser.
2. Enter the IP address of the DeviceMaster in the URL field.

Note: If you do not know the IP address, you can view the IP address in PortVision DX.
3. Click the port number that you want to configure socket port settings (serial, TCP connection configuration, and UDP connection configuration).

Note: See the web page Help system, if you need information about configuring sockets or serial tunneling. The Help system provides detailed configuration procedures and descriptions for all fields. See [Web Page Help System](#) on Page 67 for information about downloading the help file separately.
4. Click **Save** to return to the *Server Status* page.
5. Optionally, access the following pages to configure additional settings:

SocketServer after v9.xx

 - a. Click the **Network** tab to change the network settings.
 - b. Click the **Security** tab to enable DeviceMaster security.
 - c. Click the **Email** tab to configure email notification services.
 - d. Click the **RFC1006** tab to configure RFC1006 settings.

PortVision DX

There are several ways to access the socket configuration (NS-Link or SocketServer) page for the DeviceMaster using PortVision DX.

Note: The procedures in this subsection support SocketServer v9.xx and higher. If you are using a SocketServer version less than v9.xx, you may want to refer to the [Revision D of this guide](#).

1. If necessary, start PortVision DX, right-click the DeviceMaster that you want to configure, and click **Webpage**.
2. Click the port for which you want to configure socket port settings (serial, TCP connection configuration, and UDP connection configuration).

Note: For socket configuration information see the Help system. Click the ? in a configuration area for field specific information or the Help button at the bottom of the page to view page level help. To locate configuration procedures, scroll to the top of the Help file and view the Table of Contents.
3. Click **Save** to return to the *Server Status* (main) page.
4. Optionally, access the following pages to configure additional settings.
 - e. Click the **Network** tab to change the network settings.
 - f. Click the **Security** tab to enable DeviceMaster security.
 - g. Click the **Email** tab to configure email notification services.
 - h. Click the **RFC1006** tab to configure RFC1006 (ISO over TCP) settings.

SocketServer Versions

The [SocketServer Overview](#) discusses that the default SocketServer web page is the same as the NS-Link web page. If the NS-Link driver is not running (not installed or disabled), SocketServer loads when you open a web browser session.

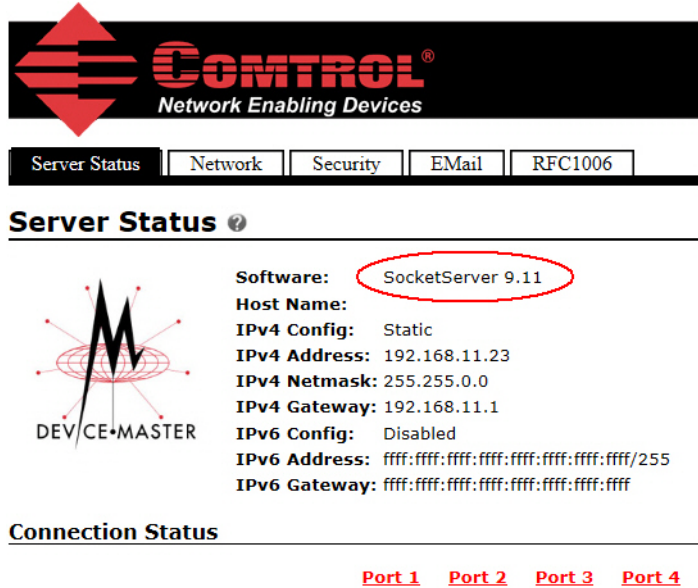

CONTROL
Network Enabling Devices

Server Status | Network | Security | EMail | RFC1006

Server Status ?



Software: SocketServer 9.11
Host Name:
IPv4 Config: Static
IPv4 Address: 192.168.11.23
IPv4 Netmask: 255.255.0.0
IPv4 Gateway: 192.168.11.1
IPv6 Config: Disabled
IPv6 Address: ffff:ffff:ffff:ffff:ffff:ffff:ffff:ffff/255
IPv6 Gateway: ffff:ffff:ffff:ffff:ffff:ffff:ffff:ffff

Connection Status

[Port 1](#) [Port 2](#) [Port 3](#) [Port 4](#)

Your SocketServer or NS-Link version may be different than these examples. These examples illustrate NS-Link and SocketServer v9.xx or higher.

The top illustration shows the web page before a NS-Link device driver installation and the bottom illustration shows the web page after a device driver installation.

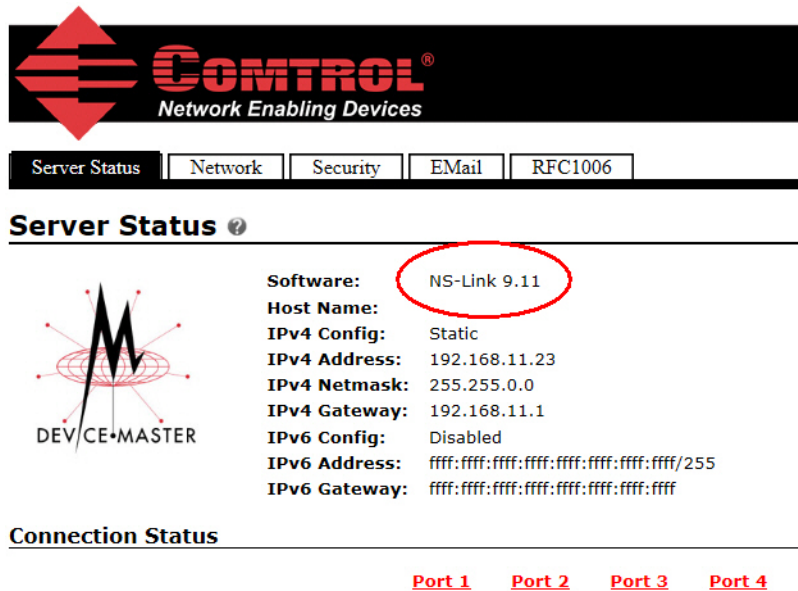

CONTROL
Network Enabling Devices

Server Status | Network | Security | EMail | RFC1006

Server Status ?



Software: NS-Link 9.11
Host Name:
IPv4 Config: Static
IPv4 Address: 192.168.11.23
IPv4 Netmask: 255.255.0.0
IPv4 Gateway: 192.168.11.1
IPv6 Config: Disabled
IPv6 Address: ffff:ffff:ffff:ffff:ffff:ffff:ffff:ffff/255
IPv6 Gateway: ffff:ffff:ffff:ffff:ffff:ffff:ffff:ffff

Connection Status

[Port 1](#) [Port 2](#) [Port 3](#) [Port 4](#)

DeviceMaster Security

This subsection provides a basic understanding of the DeviceMaster security options, and the repercussions of setting these options. See [Removing DeviceMaster Security Features](#) on Page 177 if you need to reset DeviceMaster security options. See [Returning the DeviceMaster to Factory Defaults](#) on Page 179 if you want to return the DeviceMaster settings to their default values.

Understanding Security Methods and Terminology

The following table provides background information and definitions.

Term or Issue	Explanation
CA (Client Authentication certificate) †	<p>If configured with a CA certificate, the DeviceMaster requires all SSL/TLS clients to present an RSA identity certificate that has been signed by the configured CA certificate. As shipped, the DeviceMaster is not configured with a CA certificate and all SSL/TLS clients are allowed.</p> <p>This uploaded CA certificate that is used to validate a client's identity is sometimes referred to as a <i>trusted root certificate</i>, a <i>trusted authority certificate</i>, or a <i>trusted CA certificate</i>. This CA certificate might be that of a trusted commercial certificate authority or it may be a privately generated certificate that an organization creates internally to provide a mechanism to control access to resources that are protected by the SSL/TLS protocols.</p> <p>See Key and Certificate Management on Page 87 for more information. This section does not discuss the creation of CA Certificates.</p>
Client Authentication	<p>A process using paired keys and identity certificates to prevent unauthorized access to the DeviceMaster. Client authentication is discussed in Client Authentication on Page 80 and Changing Keys and Certificates on Page 90.</p>
DH Key Pair Used by SSL Servers †	<p>This is a private/public key pair that is used by some cipher suites to encrypt the SSL/TLS handshaking messages. Possession of the private portion of the key pair allows an eavesdropper to decrypt traffic on SSL/TLS connections that use DH encryption during handshaking.</p> <p>The DH (Diffie-Hellman) key exchange, also called exponential key exchange, is a method of digital encryption that uses numbers raised to specific powers to produce decryption keys on the basis of components that are never directly transmitted, making the task of a would-be code breaker mathematically overwhelming.</p> <p>The most serious limitation of Diffie-Hellman (DH key) in its basic or <i>pure</i> form is the lack of authentication. Communications using Diffie-Hellman all by itself are vulnerable to man in the middle attacks. Ideally, Diffie-Hellman should be used in conjunction with a recognized authentication method such as digital signatures to verify the identities of the users over the public communications medium.</p> <p>See Certificates and Keys on Page 80 and Key and Certificate Management on Page 87 for more information.</p>
<p>† All DeviceMaster units are shipped from the factory with identical configurations. They all have the identical, self-signed, Control Server RSA Certificates, Server RSA Keys, Server DH Keys, and no Client Authentication Certificates. For maximum data and access security, you should configure all DeviceMaster units with custom certificates and keys.</p>	

Term or Issue	Explanation
Digital Certificate	<p>A digital certificate is an electronic <i>credit card</i> that establishes your credentials when doing business or other transactions on the Web. It is issued by a certification authority (CA). It contains your name, a serial number, expiration dates, a copy of the certificate holder's public key (used for encrypting messages and digital signatures), and the digital signature of the certificate-issuing authority so that a recipient can verify that the certificate is real. Some digital certificates conform to a standard, X.509. Digital certificates can be kept in registries so that authenticating users can look up other users' public keys.</p> <p>See Key and Certificate Management on Page 87 for more information.</p>
PKI (public key infrastructure)	<p>A public key infrastructure (PKI) enables users of a basically unsecure public network such as the Internet to securely and privately exchange data and money through the use of a public and a private cryptographic key pair that is obtained and shared through a trusted authority. The public key infrastructure provides for a digital certificate that can identify an individual or an organization and directory services that can store and, when necessary, revoke the certificates. Although the components of a PKI are generally understood, a number of different vendor approaches and services are emerging. Meanwhile, an Internet standard for PKI is being worked on.</p> <p>The public key infrastructure assumes the use of public key cryptography, which is the most common method on the Internet for authenticating a message sender or encrypting a message. Traditional cryptography has usually involved the creation and sharing of a secret key for the encryption and decryption of messages. This secret or private key system has the significant flaw that if the key is discovered or intercepted by someone else, messages can easily be decrypted. For this reason, public key cryptography and the public key infrastructure is the preferred approach on the Internet. (The private key system is sometimes known as symmetric cryptography and the public key system as asymmetric cryptography.)</p> <p>A public key infrastructure consists of:</p> <ul style="list-style-type: none"> • A certificate authority (CA) that issues and verifies digital certificate. A certificate includes the public key or information about the public key • A registration authority (RA) that acts as the verifier for the certificate authority before a digital certificate is issued to a requestor • One or more directories where the certificates (with their public keys) are held • A certificate management system <p>For more information, see SSL Authentication on Page 79, SSL Performance on Page 82, SSL Cipher Suites on Page 82, and DeviceMaster Supported Cipher Suites on Page 83.</p>

Term or Issue	Explanation
RSA Key Pair†	<p>This is an algorithm for public-key cryptography. It is the first algorithm known to be suitable for signing as well as encryption. RSA is widely used in electronic commerce protocols, and is believed to be sufficiently secure given sufficiently long keys and the use of up-to-date implementations. The system includes a communications channel coupled to at least one terminal having an encoding device, and to at least one terminal having a decoding device.</p> <ul style="list-style-type: none"> • Public key is a value provided by some designated authority as an encryption key that, combined with a private key derived from the public key, can be used to effectively encrypt messages and digital signatures. • Private Key <ul style="list-style-type: none"> - One half of the <i>key pair</i> used in conjunction with a public key - Both the public and the private keys are needed for encryption / decryption but only the owner of a private key ever needs to know it. Using the RSA system, the private key never needs to be sent across the Internet. - The private key is used to decrypt text that has been encrypted with the public key. <p>Thus, if <i>User A</i> sends <i>User B</i> a message, <i>User A</i> can find out <i>User B</i>'s public key (but not <i>User B</i>'s private key) from a central administrator and encrypt a message to <i>User B</i> using <i>User B</i>'s public key. When <i>User B</i> receives it, <i>User B</i> decrypts it with <i>User B</i>'s private key. In addition to encrypting messages (which ensures privacy), <i>User B</i> can authenticate <i>User B</i> to <i>User A</i> (so that <i>User A</i> knows that it is really <i>User B</i> who sent the message) by using <i>User B</i>'s private key to encrypt a digital certificate.</p> <p>See Key and Certificate Management on Page 87 for more information.</p>
SSH (Secure Shell)	<p>Secure Shell (SSH) allows data to be exchanged using a secure channel between two networked devices. Replaces telnet which has no security. SSH requires password authentication – even if password is empty.</p> <p>See SSH Server on Page 79 for more information.</p>
SSL (Secure Sockets Layer)	<p>The Secure Sockets Layer (SSL) is the predecessor of (TLS) Transport Layer Security.</p> <p>SSL is a commonly-used protocol for managing the security of a message transmission on the Internet. SSL has recently been succeeded by Transport Layer Security (TLS), which is based on SSL. SSL uses a program layer located between the Internet's Hypertext Transfer Protocol (HTTP) and Transport Control Protocol (TCP) layers.</p> <p>SSL is included as part of both the Microsoft and Netscape browsers and most Web server products. Developed by Netscape, SSL also gained the support of Microsoft and other Internet client/server developers as well and became the de facto standard until evolving into Transport Layer Security.</p> <p>SSL uses the public-and-private key encryption system from RSA, which also includes the use of a digital certificate.</p> <p>See Pages 79 through 83 for detailed information about SSL.</p> <p>Note: <i>Two slightly different SSL protocols are supported by the DeviceMaster: SSLv3 and TLSv1.</i></p>

Term or Issue	Explanation
<p>TLS (Transport Layer Security)</p>	<p>Transport Layer Security (TLS) is a protocol that ensures privacy between communicating applications and their users on the Internet. When a server and client communicate, TLS ensures that no third party may eavesdrop or tamper with any message. TLS is the successor to the Secure Sockets Layer (SSL).</p> <p>TLS and SSL are not interoperable. The TLS protocol does contain a mechanism that allows TLS implementation to back down to SSL 3.0.</p>
<p>Secure Data Mode</p>	<p>TCP connections that carry data to/from the DeviceMaster serial ports are encrypted using SSL or TLS security protocols. See Security Modes on Page 77 and Configure/Enable Security Features Overview on Page 84 for more information.</p>
<p>Secure Config Mode</p>	<p>Unencrypted access to administrative and diagnostic functions are disabled. See Security Modes on Page 77 and Configure/Enable Security Features Overview on Page 84 for more information.</p>
<p>Secure Monitor Data Mode via Telnet</p>	<p>Allows monitoring of a single serial port on the DeviceMaster while the port is configured for Secure Data Mode. For more information see, the Enable Monitoring Secure Data via Telnet option on Page 85.</p>
<p><i>Man in the Middle attack</i></p>	<p>A man in the middle attack is one in which the attacker intercepts messages in a public key exchange and then retransmits them, substituting his own public key for the requested one, so that the two original parties still appear to be communicating with each other.</p> <p>The attack gets its name from the ball game where two people try to throw a ball directly to each other while one person in between them attempts to catch it. In a man in the middle attack, the intruder uses a program that appears to be the server to the client and appears to be the client to the server. The attack may be used simply to gain access to the message, or enable the attacker to modify the message before retransmitting it.</p>
<p><i>How Public and Private Key Cryptography Works</i></p>	<p>In public key cryptography, a public and private key are created simultaneously using the same algorithm (a popular one is known as RSA) by a certificate authority (CA).</p> <p>The private key is given only to the requesting party and the public key is made publicly available (as part of a digital certificate) in a directory that all parties can access.</p> <p>The private key is never shared with anyone or sent across the Internet. You use the private key to decrypt text that has been encrypted with your public key by someone else (who can find out what your public key is from a public directory).</p> <p>Thus, if <i>User A</i> sends <i>User B</i> a message, <i>User A</i> can find out <i>User B's</i> public key (but not <i>User B's</i> private key) from a central administrator and encrypt a message to <i>User B</i> using <i>User B's</i> public key. When <i>User B</i> receives it, <i>User B</i> decrypts it with <i>User B's</i> private key. In addition to encrypting messages (which ensures privacy), <i>User B</i> can authenticate <i>User B</i> to <i>User A</i> (so <i>User A</i> knows that it is really <i>User B</i> who sent the message) by using <i>User B's</i> private key to encrypt a digital certificate. When <i>User A</i> receives it, <i>User A</i> can use <i>User B's</i> public key to decrypt it.</p>

Term or Issue	Explanation
<i>Who Provides the Infrastructure?</i>	<p>A number of products are offered that enable a company or group of companies to implement a PKI. The acceleration of e-commerce and business-to-business commerce over the Internet has increased the demand for PKI solutions. Related ideas are the virtual private network (VPN) and the IP Security (IPsec) standard. Among PKI leaders are:</p> <ul style="list-style-type: none"> • RSA, which has developed the main algorithms used by PKI vendors. • Verisign, which acts as a certificate authority and sells software that allows a company to create its own certificate authorities. • GTE CyberTrust, which provides a PKI implementation methodology and consultation service that it plans to vend to other companies for a fixed price. • Xcert, whose Web Sentry product that checks the revocation status of certificates on a server, using the Online Certificate Status Protocol (OCSP). • Netscape, whose Directory Server product is said to support 50 million objects and process 5,000 queries a second; Secure E-Commerce, which allows a company or extranet manager to manage digital certificates; and Meta-Directory, which can connect all corporate directories into a single directory for security management.
	<p>The following topic references are from: http://searchsecurity.techtarget.com/</p> <ul style="list-style-type: none"> • PKI (public key infrastructure) • How Public/Private Key Cryptography Works • Who Provides the Infrastructure • Digital Certificate • DH Key • Man in the Middle attack <p>The RSA Key pair topic reference is from: http://en.wikipedia.org/wiki/RSA</p>

TCP and UDP Socket Ports Used by the DeviceMaster

Following list is all of the logical TCP and UDP socket ports implemented in DeviceMasters.

Socket Port Number	Description
22 SSH 23 Telnet	TCP Ports 22 (ssh) and 23 (telnet) are used for administrative and diagnostic purposes and aren't required for normal use and are enabled by default and Port 23 may be disabled.
80 HTTP 443 SSL or HTTPS	TCP Ports 80 (http) and 443 (https) are used by the web server for administration and configuration and are enabled by default and cannot be disabled.
102 RFC1006	TCP Port 102 is used for RFC1006 (ISO over TCP) serial port access. Not used for normal NS-Link SocketServer access. The RFC1006 server can be disabled by setting the server port number to -1 and is enabled by default.
161 SNMP	UDP Port 161 is used by the SNMP agent if SNMP is enabled which is the default.
4606	TCP Port 4606 is required if you want to use NS-Link or PortVision DX if you want to update firmware without setting up a TFTP server and this port cannot be disabled.
4607	TCP Port 4607 is only used for diagnostic purposes and isn't required for normal operation and this port cannot be disabled. If SocketServer is to be used, then the user may enable usage of TCP or UDP ports for access to the serial ports. These ports are not enabled by default and are also user configurable to different values. Defaults for TCP would begin at 8000 and for UDP would begin at 7000.
TCP 8000 - 8xxx	Incremented per serial port on the DeviceMaster. For example: A DeviceMaster 16- port would have Ports 8000 through 8015.
UDP 7000 - 7xxx	Incremented per serial port on the DeviceMaster. For example: A DeviceMaster 16- port would have Ports 7000 through 7015.

DeviceMaster Security Features

The following subsections provide information about DeviceMaster security features.

Security Modes

The DeviceMaster supports two security modes.

Security Mode	Description
Secure Data	<p>SSL encryption for serial port data streams for both NS-Link and SocketServer. Secure Data mode:</p> <ul style="list-style-type: none"> Requires SSL encryption of TCP connections to SocketServer (Ports 8000, 8001, 8002, and so forth). Disables UDP access to SocketServer. Disables RFC1006 (ISO-over-TCP) access to SocketServer. Disables MAC-mode access to serial ports. MAC mode admin and ID commands are still allowed. Requires SSL encryption of NS-Link TCP connections (Port 4606). Not directly supported by NS-Link drivers for Windows and Linux. The Linux driver has been tested using stunnel, but manual setup is required. Requires SSH instead of telnet connection to the diagnostic log (TCP Port 4607). Two values for http READ and WRITE commands: A2: Enable.
Secure Config	<p>Encrypts/authenticates configuration and administration operations (web server, IP settings, load SW, and so forth.). Secure Config mode:</p> <ul style="list-style-type: none"> Disables MAC mode admin commands except for ID request†. Disables TCP/IP admin commands except for ID request†. Disables telnet console access (Port 23)†. Disables unencrypted http:// access via Port 80. Disables e-mail notification and SNMP features. Two values for http READ and WRITE commands: A3: Enable.
† Affects both RedBoot and SocketServer / NS-Link applications.	

Secure Data Mode and Secure Config Mode Comparison

This table provides information that compares **Secure Data** and **Secure Config** modes.

Feature	Secure Data	Secure Config	Secure Data/ Secure Config
MAC (admin)	enabled	disabled †	disabled †
MAC (async)	disabled	enabled	disabled
TCP 4606 (admin)	SSL, enabled	clear, disabled †	SSL, disabled †
TCP 4606 (async)	SSL	clear	SSL
UDP	disabled	user-configured	disabled
telnet/RFC2217	user-configured	user-configured	user-configured
RFC1006	disabled	user-configured	disabled
4607 (diag log)	SSH	telnet	SSH
8000 (serial port)	SSL	clear	SSL
console (config)	telnet on Port 23 SSH on Port 22	SSH on Port 22	SSH on Port 22
web	clear on Port 80 SSL on Port 443	SSL on Port 443	SSL on Port 443
SMTP, SNMP	user-configured	disabled	disabled
RedBoot MAC	enabled	disabled †	disabled †
RedBoot 4606	enabled	disabled †	disabled †
RedBoot telnet	user-configured	disabled	disabled

Security Comparison

This table displays addition information about security feature comparisons.

Supported by	Weakest				Strongest	
	0	1	2	3	3	4
	None	Password	Authenti- cation	Secure Config	Secure Data	Key & Certificate
RedBoot	yes	yes	yes	no	yes	no
SocketServer	yes	yes	yes	yes	yes	yes
NS-Link Driver/MAC	yes	yes	yes	no	no	no
NS-Link Driver/IP	yes	yes	yes	yes		
Serial Monitoring	yes	yes	yes	no	yes †	no
TCP to Serial Ports	yes	yes	yes	no	no	no
SSH to Serial Ports	no	no	no	yes	yes	yes
UDP to Serial Ports	yes	yes	yes	disabled	disabled	disabled
Telnet/Port23	yes	yes	yes	disabled	yes †	disabled
SSH Telnet/Port 22	yes	yes	yes	yes	yes	yes
Telnet Port 4607	yes	yes	yes	disabled	yes	yes
SSH (PuTTY) 4607	no	no	no	yes	disabled	disabled
HTTP (Port 80)	yes	yes	yes	disabled	disabled	disabled
HTTPS (Port 443)	no	no	no	yes	yes	yes
Email	yes	yes	yes	disabled	disabled	disabled

	Weakest			Strongest		
SNMP	yes	yes	yes	disabled	disabled	disabled
RFC1006	yes	yes	yes	disabled	disabled	disabled

† *Enable Monitoring Secure Data via Telnet must be enabled. SSH does not support port monitoring. You can set the **securemon enable** option.*

admin commands are disabled except for read-only ID command required by NS-Link to identify the device.

The intention is to allow NS-Link to operate through an SSL connection to Port 4606 while is in **Secure Data Mode**, and to allow NS-Link to operate through a MAC connection with **Secure Config Mode** enabled and **Secure Data Mode** disabled.

SSH Server

The DeviceMaster SSH server has the following characteristics:

- Requires password authentication – even if password is empty.
- Enabled/disabled along with telnet access independently of **Secure Data** and **Secure Config Modes**.
- The DeviceMaster uses third-party MatrixSSH library from PeerSec Networks: <http://www.peersec.com/>.

SSL Overview

DeviceMaster SSL provides the following features:

- Provides both encryption and authentication.
 - Encryption prevents a third-party eavesdropper from viewing data that is being transferred.
 - Authentication allows both the client (that is, web browser) and server (that is, DeviceMaster) to ensure that only desired parties are allowed to establish connections. This prevents both unauthorized access and *man-in-the-middle* attacks on the communications channel.
- Two slightly different SSL protocols are supported by the DeviceMaster, SSLv3 and TLSv1.
- The DeviceMaster uses third-party MatrixSSL library from PeerSec Networks: <http://www.peersec.com/matrixssl.html>.

SSL Authentication

DeviceMaster SSL authentication has the following features:

- Authentication means being able to verify the identity of the party at the other end of a communications channel. A username/password is a common example of authentication.
- SSL/TLS protocols allow authentication using either RSA certificates or DSS certificates. DeviceMaster supports only RSA certificates.
- Each party (client and server) can present an ID certificate to the other.
- Each ID certificate is signed by another *authority* certificate or key.
- Each party can then verify the validity of the other's ID certificate by verifying that it was signed by a trusted authority. This verification requires that each party have access to the certificate/key that was used to sign the other party's ID certificate.

Server Authentication

Server Authentication is the mechanism by which the DeviceMaster proves its identity.

- The DeviceMaster (generally an SSL server) can be configured by uploading an ID certificate that is to be presented to clients when they connect to the DeviceMaster.

- The private key used to sign the certificate must also be uploaded to the DeviceMaster.
Note: Possession of that private key will allow eavesdroppers to decrypt all traffic to and from the DeviceMaster.
- The corresponding public key can be used to verify the ID certificate but not to decrypt traffic.
- All DeviceMaster are shipped from the factory with identical self-signed ID certificates and private keys. This means that somebody could (with a little effort) extract the factory default private key from the DeviceMaster firmware and use that private key to eavesdrop on traffic to/from any other DeviceMaster that is being used with the default private key.
- The public/private key pairs and the ID certificates can be generated using **openssl** command-line tools.
- If the server authentication certificate in the DeviceMaster is not signed by an authority known to the client (as shipped, they are not), then interactive SSL clients such as web browsers will generally warn the user.
- If the name in server authentication certificate does not match the *hostname* that was used to access the server, then interactive SSL clients such as web browsers will generally warn the user.

Client Authentication

Client Authentication is the mechanism by which the DeviceMaster verifies the identity of clients (that is, web browsers and so forth).

- Clients can generally be configured to accept a particular unknown server certificate so that the user is not subsequently warned.
- The DeviceMaster (generally an SSL server) can be configured by uploading a trusted *authority* certificate that will be used to verify the ID certificates presented to the DeviceMaster by SSL clients. This allows you to restrict access to the DeviceMaster to a limited set of clients which have been configured with corresponding ID certificates.
- DeviceMaster units will be shipped without an authority certificate and will not require clients to present ID certificates. This allows any and all SSL clients to connect to the DeviceMaster.

Certificates and Keys

To control access to the DeviceMaster's SSL/TLS protected resources you should create your own custom CA certificate and then configure authorized client applications with identity certificates signed by the custom CA certificate.

This uploaded CA certificate that is used to validate a client's identity is sometimes referred to as a *trusted root certificate*, a *trusted authority certificate*, or a *trusted CA certificate*. This CA certificate might be that of a trusted commercial certificate authority or it may be a privately generated certificate that an organization creates internally to provide a mechanism to control access to resources that are protected by the SSL/TLS protocols.

The following is a list that contains additional information about certificates and keys:

- By default, the DeviceMaster is shipped without a CA (Certificate Authority) and therefore allowing connections from any SSL/TLS client. If desired, controlled access to SSL/TLS protected features can be configured by uploading a client authentication certificate to the DeviceMaster.
- Certificates can be obtained from commercial certificate authorities (VeriSign, Thawte, Entrust, and so forth.).
- Certificates can be created by users for their own use by using **openssl** command line tools or other applications.
- Certificates and keys to be uploaded to the DeviceMaster must be in the **.DER** binary file format, not in the **.PEM** ASCII file format. (The **openssl** tools can create files in either format and can convert files back and forth between the two formats.)

- Configuring Certificates and keys are configured by four uploaded files on the bottom *Key and Certificate Management* portion of the *Edit Security Configuration* web page:

- **RSA Key Pair used by SSL and SSH servers**

This is a private/public key pair that is used for two purposes:

- It is used by some cipher suites to encrypt the SSL/TLS handshaking messages. Possession of the private portion of this key pair allows an eavesdropper to both decrypt traffic on SSL/TLS connections that use RSA encryption during handshaking.
- It is used to sign the Server RSA Certificate in order to verify that the DeviceMaster is authorized to use the server RSA identity certificate. Possession of the private portion of this key pair allows somebody to pose as the DeviceMaster.

If the Server RSA Key is replaced, a corresponding RSA server certificate must also be generated and uploaded as a matched set or clients are not able to verify the identity certificate.

- **RSA Server Certificate used by SSL servers**

- This is the RSA identity certificate that the DeviceMaster uses during SSL/TLS handshaking to identify itself. It is used most frequently by SSL server code in the DeviceMaster when clients open connections to the DeviceMaster's secure web server or other secure TCP ports. If a DeviceMaster serial port configuration is set up to open (as a client), a TCP connection to another server device, the DeviceMaster also uses this certificate to identify itself as an SSL client if requested by the server.
- In order to function properly, this certificate must be signed using the Server RSA Key. This means that the server RSA certificate and server RSA key must be replaced as a pair.

- **DH Key pair used by SSL servers**

This is a private/public key pair that is used by some cipher suites to encrypt the SSL/TLS handshaking messages.

Possession of the private portion of the key pair allows an eavesdropper to decrypt traffic on SSL/TLS connections that use DH encryption during handshaking.

- **Client Authentication Certificate used by SSL servers**

If configured with a CA certificate, the DeviceMaster requires all SSL/TLS clients to present an RSA identity certificate that has been signed by the configured CA certificate. As shipped, the DeviceMaster is not configured with a CA certificate and all SSL/TLS clients are allowed.

SSL Performance

The DeviceMaster has these SSL performance characteristics:

- Encryption/decryption is a CPU-intensive process, and using encrypted data streams will limit the number of ports that can be maintained at a given serial throughput. For example, the table below shows the number of ports that can be maintained by SocketServer at 100% throughput for various cipher suites and baud rates.

	9600	38400	57600	115200
RC4-MD5	32	16	10	5
RC4-SHA	32	13	9	4
AES128-SHA	28	7	5	2
AES256-SHA	26	7	4	2
DES3-SHA	15	3	2	1

Note: *These throughputs required 100% CPU usage, so other features such as the web server are very unresponsive at the throughputs shown above. To maintain a usable web interface, one would want to stay well below the maximum throughput/port numbers above.*

- The overhead required to set up an SSL connection is also significant. The time required to open a connection to SocketServer varies depending on the public-key encryption scheme used for the initial handshaking. Typical setup times for the three public-key encryption schemes supported by the DeviceMaster are shown below:
 - RSA 0.66 seconds
 - DHE 3.84 seconds
 - DHA 3.28 seconds
- Since there is a certain amount of overhead for each block of data sent/received on an SSL connection, the SocketServer polling rate and size of blocks that are written to the SocketServer also has a noticeable effect on CPU usage. Writing larger blocks of data and a slower SocketServer polling rate will decrease CPU usage and allow somewhat higher throughputs.

SSL Cipher Suites

This subsection provides information about SSL cipher suites.

- An SSL connection uses four different facilities, each of which can use one of several different ciphers or algorithms. A particular combination of four ciphers/algorithms is called a "cipher suite".
- A Cipher Suite consists of
 - Public Key Encryption Algorithm
 - Used to protect the initial handshaking and connection setup.
 - Typical options are RSA, DH, DHA, DHE, EDH, SRP, PSK
 - DeviceMaster supports RSA, DHA, DHE
 - Authentication Algorithm
 - Used to verify the identities of the two parties to each other.
 - Typical options are RSA, DSA, ECDSA
 - DeviceMaster supports only RSA
 - Stream Cipher
 - Used to encrypt the user-data exchanged between the two parties.
 - Typical options: RC4, DES, 3DES, AES, IDEA, Camellia, NULL
 - DeviceMaster supports RC4, 3DES, AES

- Message Authentication Code
 - hash function (checksum) used to verify that each message frame has not be corrupted or changed while in transit.
 - typical options include MD5, SHA, MD2, MD4
 - DeviceMaster supports MD5, SHA
- In the design of the SSL/TLS protocols the choices of four of the above are not independent of each other: only certain combinations are defined by the standards. The standard combinations of protocol (SSL or TLS) and cipher suites support by DeviceMaster are shown in the attached table.

DeviceMaster Supported Cipher Suites

The DeviceMaster supports the cipher suites:

Protocol	Public Key	Authentication	Cipher	MAC
SSL	RSA	RSA	3DES	SHA
SSL	RSA	RSA	RC4	SHA
SSL	RSA	RSA	RC4	MD5
SSL	DHE	RSA	3DES	SHA
SSL	DHA	RSA	RC4	MD5
SSL	RSA	RSA	NULL	MD5
SSL	RSA	RSA	NULL	SHA
TLS	RSA	RSA	AES128	SHA
TLS	RSA	RSA	AES256	SHA
TLS	DHE	RSA	AES128	SHA
TLS	DHE	RSA	AES256	SHA
TLS	DHA	RSA	AES128	SHA
TLS	DHA	RSA	AES256	SHA

SSL Resources

You can refer to the following SSL resources for more information:

- Standard reference book is SSL and TLS by Eric Rescorla
- Wikipedia page on SSL/TLS provides a good overview: <http://en.wikipedia.org/wiki/TLS>
- **openssl** contains command-line tools to do the following. More information is available at: <http://www.openssl.org/>
 - Create/examine keys/certificates
 - Act as client or server
- **ssldump** is a -command line tool that displays a human-readable dump of an SSL connection's handshaking and traffic:. More information can be found at: <http://www.rtfm.com/ssldump/>.
 - If provided with server's private key, can decrypt data stream
 - Can display decoded data stream in ASCII/hex
 - Can display contents of handshaking packets (including ID certificates)

Configure/Enable Security Features Overview

You can enable DeviceMaster security features the web page (SocketServer or the NS-Link version). *Key and Certificate Management* must be done using the *Security* tab in the DeviceMaster web pages.

If you want secure COM ports, you must also **Enable SSL Mode** and enter any applicable server or client certificates in the NS-Link device driver for Windows. See [Device Driver \(NS-Link\) Installation](#) on Page 53.

The following illustration shows the *Security Configuration* area of the **Security** tab and are discussed in the following table.

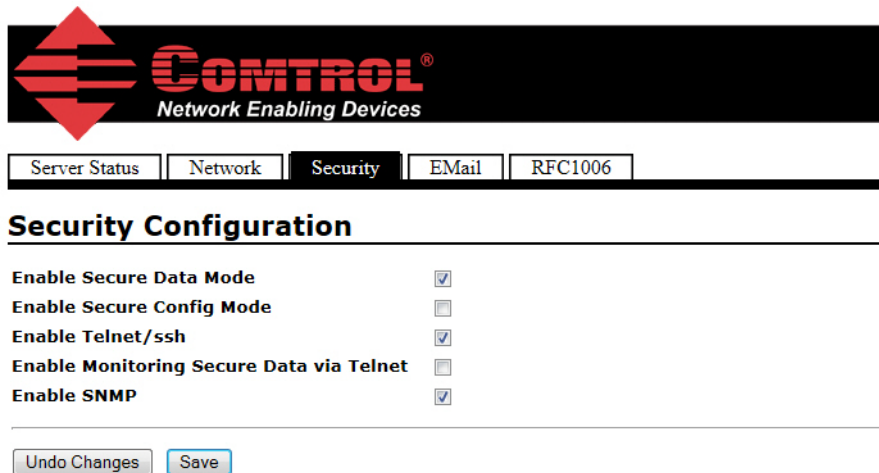

Security Option	Description
<p>Enable Secure Data Mode</p>	<p>If Secure Data Mode is enabled TCP connections which carry data to/from the serial ports will be encrypted using SSL or TLS security protocols. This includes the following:</p> <ul style="list-style-type: none"> • TCP connections to the per-serial-port TCP ports (default is 8000, 8001, 8002, and so forth) are encrypted using SSL/TLS. • TCP connections to TCP Port 4606 on which the DeviceMaster implements the Control proprietary serial driver protocol are encrypted using SSL/TLS. • Since SSL/TLS can not be used for either UDP data streams or for the Control proprietary MAC mode Ethernet driver protocol, both UDP and MAC mode serial data transport features are disabled. • In order to minimize possible security problems, e-mail and RFC1006 features are also disabled in <i>Secure Data</i> mode. <p>In addition to encrypting the data streams, it is possible to configure the DeviceMaster so that only authorized client applications can connect using SSL/TLS. See the Client Authentication discussion on Page 80 for details.</p>

Security Option	Description
<p>Enable Secure Config Mode</p>	<p>If Secure Config Mode is enabled, unencrypted access to administrative and diagnostic functions is disabled. Secure Config Mode changes DeviceMaster behavior as follows:</p> <ul style="list-style-type: none"> • Telnet access to administrative and diagnostic functions is disabled. SSH access is still allowed. • Unencrypted access to the web server via Port 80 (http:// URLs) is disabled. • Encrypted access to the web server via Port 443 (https:// URLs) is still allowed. • Administrative commands that change configuration or operating state which are received using the Control proprietary TCP driver protocol on TCP Port 4606 are ignored. • Administrative commands that change configuration or operating state that are received using the Control MAC mode proprietary Ethernet protocol number 0x11FE are ignored.
<p>Enable Monitoring Secure Data via Telnet</p>	<p>When checked, this allows the monitor command to be used while Secure Data Mode is enabled. When unchecked, the monitor command can only be used if Secure Data Mode is not enabled. You must click Save and reboot the DeviceMaster for the change to go into affect. This option is disabled by default.</p> <p>The Enable Monitoring Secure Data via Telnet feature allows you to monitor serial data being sent/received on a serial port (either via NS-Link or SocketServer). The monitoring is done by telnetting to the DeviceMaster and using the following commands:</p> <ul style="list-style-type: none"> • monitor [-ac] portnumber Display a live hex dump of Tx/Rx data for the specified serial port. You can only monitor one port at a time. The live dump will continue until the Enter key is pressed. See the following detailed description and examples. The data is logged when it is written/read to/from the serial port driver's Tx/Rx buffers -- as such, the relative timing between Rx/Tx bytes is not precise, but it should be sufficient to debug most problems (especially frame-oriented, command/response serial protocols). Monitoring serial data through a telnet connection does generate extra network traffic and may have small effects on the timing of DeviceMaster operations when large amounts of data are being logged at high baud rates. See Example 1 on Page 86 for more information. - The -a option enables displaying of ASCII representation of data in a column to the right the hex representation. See Example 2 on Page 86. - The -c option enables the use of color instead of < and > to indicate the data flow direction. Tx is green and Rx is red. See Example 3 on Page 87. <p style="text-align: center;"><i>(continued)</i></p>

Security Option	Description
<p><i>(Continued from the previous page)</i></p> <p>Enable Monitoring Secure Data via Telnet</p>	<ul style="list-style-type: none"> securemon [enable disable] <p>By default, monitoring of Tx/Rx data when in Secure Data Mode is not allowed through telnet (an insecure protocol). This command allows you to override that default when securemon is enabled it will allow monitoring of secure data via an insecure protocol like telnet.</p> <p>Currently, because of issues with the DeviceMaster ssh implementation, monitoring serial port data via the ssh command-line interface is not supported. It is expected that it will be supported in the future. Once it is supported, the securemon setting will not affect the ability to monitor secure data via ssh (which will always be allowed).</p>
<p>Enable Telnet/ssh</p>	<p>This option enables or disables the telnet security feature after you click Save and the DeviceMaster has been rebooted. <i>This option is enabled by default.</i></p>
<p>Enable SNMP</p>	<p>This option enables or disables the SNMP security feature after you click Save and the DeviceMaster has been rebooted. <i>This option is enabled by default.</i></p>

Example 1

The following example shows how to monitor output using a loopback plug and a program that repeatedly sends the string abcABC123 to Port 1:

```
dm> monitor 1
Serial monitoring started for port 1 -- press [Enter] to stop.
> 61 62 63 41 42 43 31 32 33
< 61 62 63 41 42 43 31 32 33
> 61 62 63 41 42 43 31 32 33
< 61 62 63 41 42 43 31 32 33
> 61 62 63 41 42 43 31 32 33
< 61 62 63 41 42 43 31 32 33
> 61 62 63 41 42 43 31 32 33
< 61 62 63 41 42 43 31 32 33
```

Example 2

The following example shows how the **-a** option enables displaying of ASCII representation of data in a column to the right the hex representation:

```
dm> monitor -a 1
Serial monitoring started for port 1 -- press [Enter] to stop.
> 61 62 63 41 42 43 31 32 33 > abcABC123
< 61 62 63 41 42 43 31 32 33 < abcABC123
> 61 62 63 41 42 43 31 32 33 > abcABC123
< 61 62 63 41 42 43 31 32 33 < abcABC123
> 61 62 63 41 42 43 31 32 33 > abcABC123
< 61 62 63 41 42 43 31 32 33 < abcABC123
> 61 62 63 41 42 43 31 32 33 > abcABC123
< 61 62 63 41 42 43 31 32 33 < abcABC123
> 61 62 63 41 42 43 31 32 33 > abcABC123
< 61 62 63 41 42 43 31 32 33 < abcABC123
> 61 62 63 41 42 43 31 32 33 > abcABC123
< 61 62 63 41 42 43 31 32 33 < abcABC123
```

Example 3

The `-c` option enables the use of color instead of `<` and `>` to indicate the data flow direction. Tx is green and Rx is red.

```
dm> monitor -c 1
Serial monitoring started for port 1 -- press [Enter] to stop.
61 62 63 41 42 43 31 32 33 61 62 63 41 42 43 31
32 33 61 62 63 41 42 43 31 32 33 61 62 63 41 42
43 31 32 33 61 62 63 41 42 43 31 32 33 61 62 63
41 42 43 31 32 33 61 62 63 41 42 43 31 32 33 61
62 63 41 42 43 31 32 33 61 62 63 41 42 43 31 32
33 61 62 63 41 42 43 31 32 33 61 62 63 41 42 43
31 32 33 61 62 63 41 42 43 31 32 33 61 62 63 41
42 43 31 32 33 61 62 63 41 42 43 31 32 33 61 62
63 41 42 43 31 32 33 61 62 63 41 42 43 31 32 33
The -a and -c options can be used together:
dm> monitor -ac 1
Serial monitoring started for port 1 -- press [Enter] to stop.
61 62 63 41 42 43 31 32 33 61 62 63 41 42 43 31 | abcABC123abcABC1
32 33 61 62 63 41 42 43 31 32 33 61 62 63 41 42 | 23abcABC123abcAB
43 31 32 33 61 62 63 41 42 43 31 32 33 61 62 63 | C123abcABC123abc
41 42 43 31 32 33 61 62 63 41 42 43 31 32 33 61 | ABC123abcABC123a
62 63 41 42 43 31 32 33 61 62 63 41 42 43 31 32 | bcABC123abcABC12
33 61 62 63 41 42 43 31 32 33 61 62 63 41 42 43 | 3abcABC123abcABC
31 32 33 61 62 63 41 42 43 31 32 33 61 62 63 41 | 123abcABC123abcA
42 43 31 32 33 61 62 63 41 42 43 31 32 33 61 62 | BC123abcABC123ab
63 41 42 43 31 32 33 61 62 63 41 42 43 31 32 33 | cABC123abcABC123
```

Key and Certificate Management

Key and Certificate management is only available in *Edit Security Configuration* web page.

Key and Certificate Management

RSA Key pair used by SSL and SSH servers	factory	<input type="button" value="Set"/>	<input type="button" value="Delete"/>
RSA Server Certificate used by SSL servers	factory	<input type="button" value="Set"/>	<input type="button" value="Delete"/>
DH Key pair used by SSL servers	factory	<input type="button" value="Set"/>	<input type="button" value="Delete"/>
Client Authentication Certificate used by SSL servers	none	<input type="button" value="Set"/>	<input type="button" value="Delete"/>

Key and Certificate Management Options	Description
<p>RSA Key pair used by SSL and SSH servers</p>	<p>This is a private/public key pair that is used for two purposes:</p> <p>It is used by some cipher suites to encrypt the SSL/TLS handshaking messages. Possession of the private portion of this key pair allows an eavesdropper to both decrypt traffic on SSL/TLS connections that use RSA encryption during handshaking.</p> <p>It is used to sign the Server RSA Certificate in order to verify that the &dm; is authorized to use the server RSA identity certificate. Possession of the private portion of this key pair allows somebody to pose as the &dm;.</p> <p>If the Server RSA Key is to be replaced, a corresponding RSA identity certificate must also be generated and uploaded or clients are not able to verify the identity certificate.</p>
<p>RSA Server Certificate used by SSL servers</p>	<p>This is the RSA identity certificate that the DeviceMaster uses during SSL/TLS handshaking to identify itself. It is used most frequently by SSL server code in the DeviceMaster when clients open connections to the DeviceMaster's secure web server or other secure TCP ports. If a DeviceMaster serial port configuration is set up to open (as a client) a TCP connection to another server device, the DeviceMaster also uses this certificate to identify itself as an SSL client if requested by the server.</p> <p>In order to function properly, this certificate must be signed using the Server RSA Key. This means that the server RSA certificate and server RSA key must be replaced as a pair.</p>
<p>DH Key pair used by SSL servers</p>	<p>This is a private/public key pair that is used by some cipher suites to encrypt the SSL/TLS handshaking messages.</p> <p>Note: <i>Possession of the private portion of the key pair allows an eavesdropper to decrypt traffic on SSL/TLS connections that use DH encryption during handshaking.</i></p>
<p>Client Authentication Certificate used by SSL servers</p>	<p>If configured with a CA certificate, the DeviceMaster requires all SSL/TLS clients to present an RSA identity certificate that has been signed by the configured CA certificate. As shipped, the DeviceMaster is not configured with a CA certificate and all SSL/TLS clients are allowed.</p> <p>See Client Authentication on Page 80 for more detailed information</p>
<ul style="list-style-type: none"> • <i>All DeviceMaster units are shipped from the factory with identical configurations. They all have the identical, self-signed, Control Server RSA Certificates, Server RSA Keys, Server DH Keys, and no Client Authentication Certificates.</i> • <i>For maximum data and access security, you should configure all DeviceMaster units with custom certificates and keys.</i> 	

Using a Web Browser to Set Security Features

The follow procedures are discussed below:

- [Changing Security Configuration](#)
- [Changing Keys and Certificates](#) on Page 90

Changing Security Configuration

Use the following steps to change security settings in the DeviceMaster.

1. Enter the IP address of the DeviceMaster in the *Address* field of your web browser and press the Enter key.
2. Click the Security tab.
3. Click the appropriate check boxes in the *Security Configuration* area to enable or disable security accordingly.

Refer to the help system or [Configure/Enable Security Features Overview](#) on Page 84 for detailed information.

CONTROL
Network Enabling Devices

Server Status | Network | Security | EMail | RFC1006

Server Status

Software: SocketServer 9.11

Host Name:

IPv4 Config: Static

IPv4 Address: 192.168.11.23

IPv4 Netmask: 255.255.0.0

IPv4 Gateway: 192.168.11.1

IPv6 Config: Disabled

IPv6 Address: ffff:ffff:ffff:ffff:ffff:ffff:ffff:ffff/255

IPv6 Gateway: ffff:ffff:ffff:ffff:ffff:ffff:ffff:ffff

Connection Status

Port 1 Port 2 Port 3 Port 4

The Software displays as NS-Link, if you have installed and configured a device driver.

CONTROL
Network Enabling Devices

Server Status | Network | Security | EMail | RFC1006

Security Configuration

Enable Secure Data Mode

Enable Secure Config Mode

Enable Telnet/ssh

Enable Monitoring Secure Data via Telnet

Enable SNMP

Undo Changes Save

4. After making changes to the *Security Configuration* area, click Save.

5. Make the appropriate selection for your situation:
 - Click **Continue**, if you addition configuration and then make sure that you reboot the DeviceMaster later so that the changes take affect.
 - Click **Reboot** so that changes take affect as soon as the DeviceMaster returns online.



Changing Keys and Certificates

Use the following steps to update security keys and certificates in the DeviceMaster.

1. If necessary, enter the IP address of the DeviceMaster in the *Address* field of your web browser and press the **Enter** key.
2. Click the **Security** tab.
3. Click **Set** for the appropriate key or certificate option in the *Keys and Certificate Management* area to configure security keys and certificates.

Refer to the help system or [Key and Certificate Management](#) subsection on Page 90 for detailed information.

Key and Certificate Management

RSA Key pair used by SSL and SSH servers	factory	<input type="button" value="Set"/>	<input type="button" value="Delete"/>
RSA Server Certificate used by SSL servers	factory	<input type="button" value="Set"/>	<input type="button" value="Delete"/>
DH Key pair used by SSL servers	factory	<input type="button" value="Set"/>	<input type="button" value="Delete"/>
Client Authentication Certificate used by SSL servers	none	<input type="button" value="Set"/>	<input type="button" value="Delete"/>

4. Click **Browse** to locate the key or certificate file, highlight the file, and click **Open**.
5. Click **Upload** when you return to the *Key and Certificate Management* area. The key or certificate notation changes from *factory* or *none* to **User** when the DeviceMaster is secure.
6. You do not need to click **Save**, but changes will not take effect until the DeviceMaster is rebooted.

You can reboot the DeviceMaster by returning to the *Server Status* tab (scroll to the bottom of the page) or using PortVision DX.

Modbus Server Application Overview

The Modbus Server application was designed to provide enhanced connectivity for OPC servers and applications that require Modbus/RTU communications. While standard gateways provide connectivity for only one application per serial port, Modbus Server provides connectivity for up to six applications per serial port.

Modbus Server greatly enhances system maintenance capabilities. Included are comprehensive device and port specific diagnostic web pages that display status, message response timing, timeout, and other error counts, and overall message statistics. A serial log is also included to provide message level diagnosis.

See the [Modbus Server User Guide](#) for information about configuring or using Modbus Server.

Recommended Chassis

The following table lists the recommended DeviceMaster RTS or DeviceMaster UP chassis based on Modbus/RTU message throughput.

Throughput	1 Port	2 Ports	4 Ports	8 Ports	16 Ports	32 Ports
Very High - Message rate of up to one message every 50 ms per port (20 messages per port per second)	X	X				
High - Message rate of up to one message every 100 ms per port (10 messages per port per second)	X	X	X			
Medium - Message rate of up to one message every 200 ms per port (5 messages per port per second)	X	X	X	X		
Low - Message rate of up to one message every 500 ms per port (2 messages per port per second)	X	X	X	X	X	
Very Low - Message rate of up to one message every second per port (1 message per port per second)	X	X	X	X	X	X
Latency						
Transmit (From application to device)	2-10 ms (*)		5-20 ms (*)		0-30 ms (*)	
Receive (From device to application)	2-10 ms (*)		5-20 ms (*)	5-50 ms	10-100 ms	
(*) = Based on one Ethernet TCP/IP connection per serial port running in a normal uncongested system. The maximum overall latency will increase as the number of Ethernet TCP/IP connections increase.						

Note: These estimates are based on a Modbus/RTU request and/or response message size of 20 bytes. Actual throughput will vary depending on message size and system requirements.

What is Modbus?

Modbus/RTU (Supported by Modbus Server)

Modbus/RTU is native Modbus in hexadecimal format. These are the base Modbus messages that contain simple read and write requests. The format is as follows:

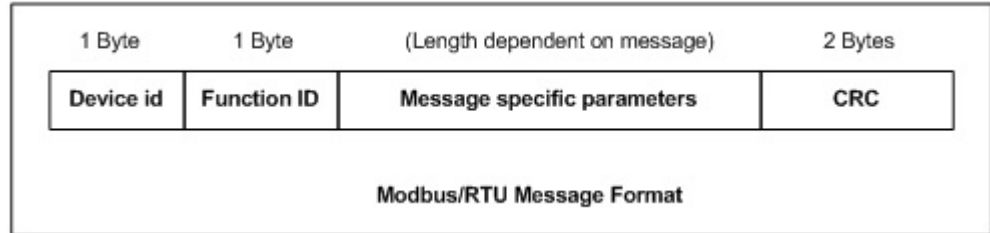

Where:

- The terms Master or Client are used to identify the sender of the message.
- The terms Slave or Server are used to identify the devices responding to the message.

Modbus/RTU is used for:

- Serial port connectivity. RS-485 is the most common, but RS-232 and RS-422 are also used.
- Ethernet TCP/IP socket connections. This is not the same as Modbus/TCP (please see next section), but does provide a very simple method of interfacing to remote devices. It is used by many applications and some OPC servers.
Note: This communication method is not used by PLCs.

Modbus/TCP (Not supported by Modbus Server)

Modbus/TCP is an Ethernet network based protocol that contains a Modbus/RTU message, with the exception of the 2 byte CRC. The Modbus/TCP message contains a header with information designed to provide message identification and routing information. The format is as follows:

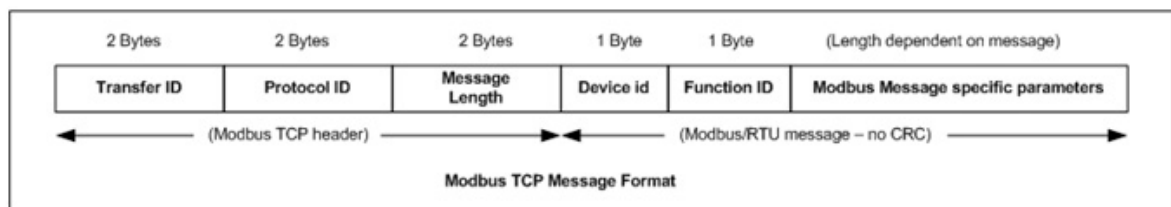

Where:

- The terms Master or Client are used to identify the sender of the message.
- The terms Slave or Server are used to identify the devices responding to the message.
- Modbus/TCP messages are typically sent to and received on a defined Ethernet TCP/IP socket of 502.
- Modbus/TCP implementations provide more capability, but also require more processing than simpler Modbus/RTU implementations.

Modbus/TCP is used for connecting advanced Ethernet based devices, such as PLCs, HMIs, SCADA Systems, and most OPC Servers to:

- Other Ethernet devices supporting Modbus/TCP.
- Remote serial Modbus/RTU devices through gateways (such as the DeviceMaster UP).

- Remote serial or Ethernet TCP/IP ASCII devices through a gateway (such as the DeviceMaster UP).

Note: Refer to the DeviceMaster UP for Modbus/TCP functionality.

Modbus Server Functionality

The Modbus Server application provides the following functionality:

- Supports Modbus/RTU over Ethernet TCP/IP connections to the corresponding serial port through intelligent Modbus message handling and routing.
- Supports only Modbus/RTU over Ethernet TCP/IP connections to a serial port.
Note: For Modbus/TCP functionality, see the [DeviceMaster UP](#).
- Supports up to six Ethernet TCP/IP connections to each serial port.
 - One TCP/IP connection can be created with the *Connect To* connection method.
 - The *Listen* connection method accepts up to five or six connections, depending if the *Connect To* connection is active.
- Supports up to 255 Modbus devices per port. Both valid, (1-247), and reserved, (248-255), device Ids are supported.
- Modbus/RTU specific message handling:
 - CRC verification of all messages received on the TCP/IP and serial interfaces.
 - Timing out of responses from slave Modbus/RTU devices.
 - Broadcast message handling on connected port only.
- System monitoring to ensure gateway operation:
 - Gateway busy.
 - Application message time-outs.
- Advanced diagnostics web pages:
 - Modbus/RTU device specific statistics and status. Up to 255 Modbus/RTU devices per port can be monitored simultaneously.
 - Serial port specific statistics, response timing, and status.
 - Serial port message logging.

- Combined with a serial port redirector, such as the Control Secure Port Redirector, can support up to six COM port connections to each serial port.

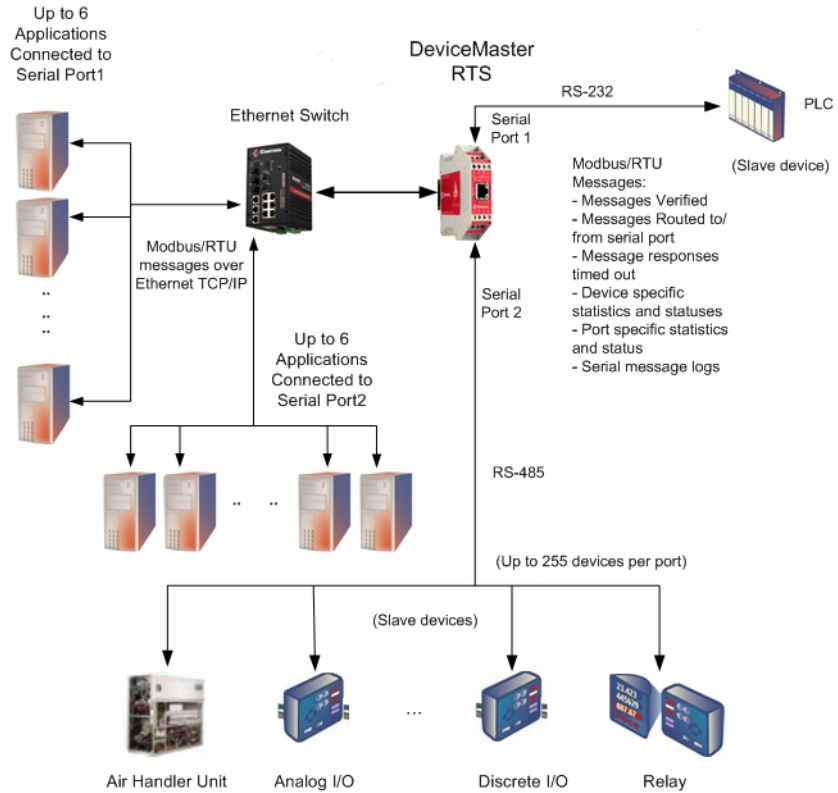

Modbus Server Connectivity

Connecting Serial Devices

This section discusses connecting your serial devices to the DeviceMaster. It also provides you with information to build serial or test cables and loopback connectors to test the serial ports.

Use the appropriate procedure to connect asynchronous serial devices to the DeviceMaster ports.

- [DB9 Connectors](#)
- [RJ45 Connectors](#) on Page 98
- [Serial Terminals \(4\) - 1E](#) on Page 101
- [Serial Terminals \(8\) - 2E](#) on Page 104

Note: Go to [Building the Serial Ribbon Cable](#) on Page 18 for connector information for the DeviceMaster 1-Port Embedded adapter.



Make sure that you have configured the ports using the NS-Link driver or SocketServer for the correct communications mode before connecting any devices. The default mode is RS-232. There is a remote possibility that connecting a serial device for the wrong mode could damage the serial device.

DB9 Connectors

This subsection provides the following information:

- Connector pin assignments (below)
- [DB9 Null-Modem Cables \(RS-232\)](#) on Page 96
- [DB9 Null-Modem Cables \(RS-422\)](#) on Page 96
- [DB9 Straight-Through Cables \(RS-232/485\)](#) on Page 96
- [DB9 Loopback Plugs](#) on Page 97
- [Connecting DB9 Serial Devices](#) on Page 97

DB9 Connector Pinouts			
Pin	RS-232	RS-422 RS-485 Full-Duplex (Master/Slave)†	RS-485 Half-Duplex
1	DCD	Not used	Not used
2	RxD	RxD-	Not used
3	TxD	TxD-	TRxD-
4	DTR	Not used	Not used
5	GND	Not used††	Not used†
6	DSR	Not used	Not used
7	RTS	TxD+	TRxD+
8	CTS	RxD+	Not used
9	RI	Not used	Not Used
†	Only 2-port models support RS-485 full-duplex.		
††	Pin 5 is tied to ground on the board, but is not used in the cable.		

Note: The DeviceMaster Serial Hub only supports RS-232.

Refer to the hardware manufacturer’s installation documentation if you need help with connector pinouts or cabling for the serial device.

This illustrates the DB9 connector signals.

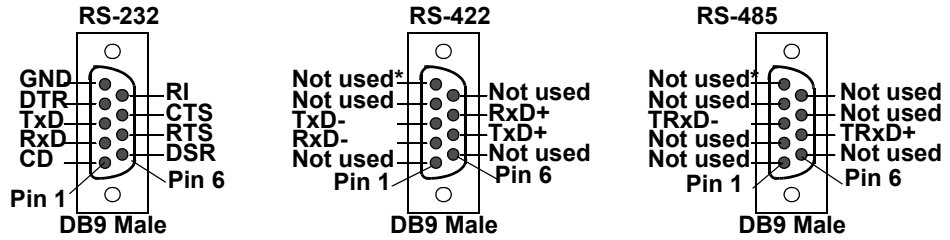

* Pin 5 is tied to ground on the board, but is not used in the cable.

DB9 Null-Modem Cables (RS-232)

Use the following figure if you need to build an RS-232 null-modem cable. A null-modem cable is required for connecting DTE devices.

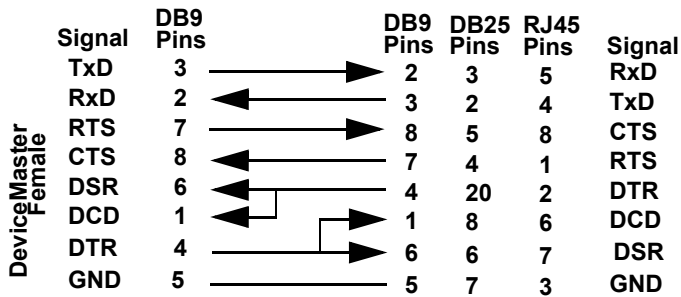

Note: You may want to purchase or build a straight-through cable and purchase a null-modem adapter. For example, a null-modem cable can be used to connect COM2 of one PC to COM2 of another PC.

DB9 Null-Modem Cables (RS-422)

Use the following figure if you need to build an RS-422 null-modem cable.

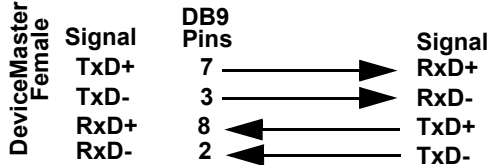

Note: RS-422 pinouts are not standardized. Each peripheral manufacturer uses different pinouts. Refer to the peripheral documentation to determine the pinouts for the signals above.

DB9 Straight-Through Cables (RS-232/485)

Use the following figure if you need to build an RS-232 or RS-485 straight-through cable. Straight-through cables are used to connect modems and other DCE devices. For example, a straight-through cable can be used to connect COM2 to a modem.

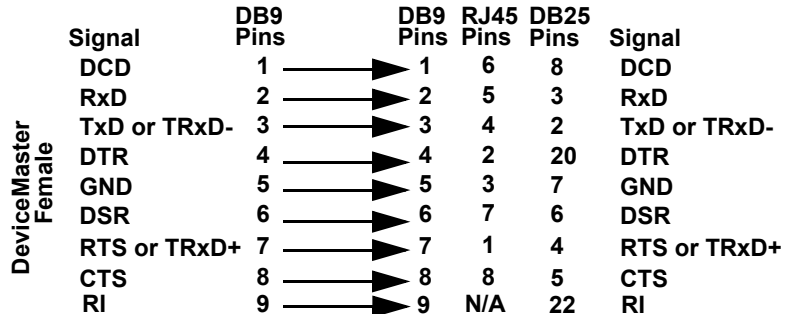

DB9 Loopback Plugs

Loopback connectors are DB9 female serial port plugs with pins wired together that are used in conjunction with application software (Test Terminal or minicom) to test serial ports. The DeviceMaster is shipped with a single loopback plug (RS-232/422).

Note: You can use Test Terminal (Windows) or minicom (Linux) to test the serial port. You can refer to [Testing Ports Using Test Terminal](#) on Page 162 for Windows systems or ftp://ftp.control.com/html/troubleshooting.htm#linux_list for Linux systems.

Wire the following pins together to build additional plugs or replace a missing RS-232 loopback plug:

- Pins 1 to 4 to 6
- Pins 2 to 3
- Pins 7 to 8 to 9

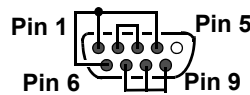

RS-232 Only
(Back View)

The RS-232 loopback plug also works for RS-422.

Wire the following pins together for an RS-422 loopback plug:

- Pins 2 to 3
- Pins 7 to 8

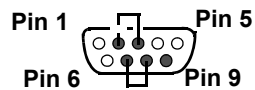

RS-422 Only
(Back View)

Connecting DB9 Serial Devices

You can use this information to connect serial devices to DB9 connectors.

1. Connect your serial devices to the appropriate serial port on the DeviceMaster using the appropriate cable.

Note: Refer to the hardware manufacturer's installation documentation if you need help with connector pinouts or cabling for the peripheral device.

2. If the DeviceMaster has Rx/Tx LEDs, verify that the devices are communicating properly. DeviceMaster 4-port and 8-port models with DB9 ports and the DeviceMaster Serial Hub 16-port provide TX/RX LEDs.

Note: DeviceMaster 1-port and 2-port models do not have TX/RX LEDs.

DB9 LEDs 

The RX (yellow) and TX (green) LEDs function accordingly when the cable is attached properly to a serial device.

* Represents port number.

- After power cycling the DeviceMaster, the RX/TX LEDs are off.
 - The LEDs do not function as described until the port has been opened by an application. You can use Test Terminal to open a port or ports if you want to test a port or ports ([Testing Ports Using Test Terminal](#) on Page 162).
 - If the port is configured for RS-232/422 mode:
 - RX LEDs (yellow) are lit
 - TX LEDs (green) are lit when as the data exits the port
 - If the port is configured for RS-485 mode:
 - RX LEDs (yellow) are lit while receiving
 - TX LEDs (green) are lit during active data transmission
3. You can refer to [Network and Device LEDs](#) on Page 175 for information about the remaining LEDs.

RJ45 Connectors

This subsection provides the following information:

- Connector pin assignments (below)
- [RJ45 Null-Modem Cables \(RS-232\)](#)
- [RJ45 Null-Modem Cables \(RS-422\)](#) on Page 99
- [RJ45 Straight-Through Cables \(RS-232/485\)](#) on Page 99
- [RJ45 Loopback Plugs](#) on Page 99
- [RJ45 RS-485 Test Cable](#) on Page 99
- [Connecting RJ45 Devices](#) on Page 100

You can build your own null-modem or straight-through RJ45 serial cables if you are using the DB9 to RJ45 adapters using the following subsections.

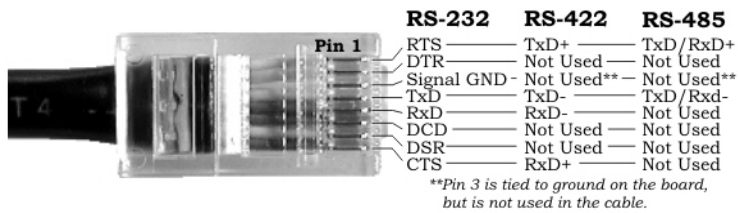

Pin	RS-232	RS-422	RS-485
1	RTS	TxD+	TRxD+
2	DTR	Not used	Not used
3	Signal GND	Not used†	Not used†
4	TxD	TxD-	TRxD-
5	RxD	RxD-	Not used
6	DCD	Not used	Not used
7	DSR	Not used	Not used
8	CTS	RxD+	Not used

† Pin 3 is tied to ground on the board, but is not used in the cable.

RJ45 Null-Modem Cables (RS-232)

Use the following figure if you need to build an RS-232 null-modem cable. A null-modem cable is required for connecting DTE devices.

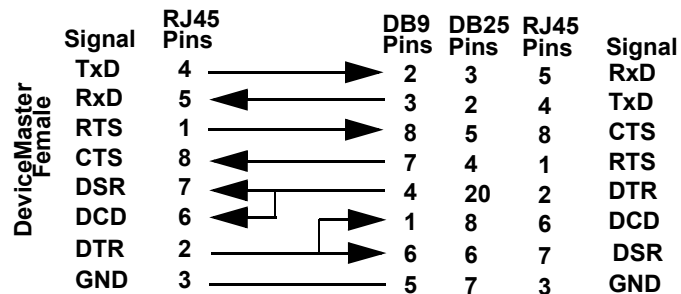

Note: You may want to purchase or build a straight-through cable and purchase a null-modem adapter. For example, a null-modem cable can be used to connect COM2 of one PC to COM2 of another PC.

RJ45 Null-Modem Cables (RS-422)

Use the following figure if you need to build an RS-422 null-modem RJ45 cable. A null-modem cable is required for connecting DTE devices.

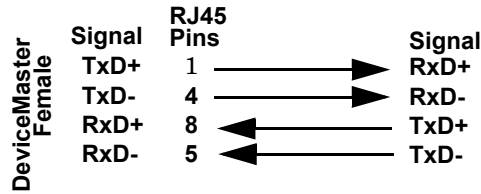

Note: RS-422 pinouts are not standardized. Each peripheral manufacturer uses different pinouts. Please refer to the documentation for the peripheral to determine the pinouts for the signals above.

RJ45 Straight-Through Cables (RS-232/485)

Use the following figure if you need to build an RS-232 or RS-485 straight-through cable. Straight-through cables are used to connect modems and other DCE devices. For example, a straight-through cable can be used to connect COM2 of one PC to COM2 to a modem.

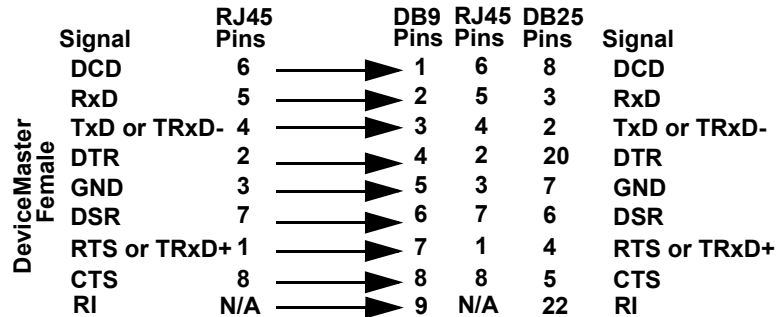

RJ45 Loopback Plugs

Loopback connectors are RJ45 serial port plugs with pins wired together that are used in conjunction with application software (Test Terminal for Windows or Minicom for Linux) to test serial ports. The DeviceMaster is shipped with a single loopback plug (RS-232/422).

- Pins 4 to 5
- Pins 1 to 8
- Pins 2 to 6 to 7

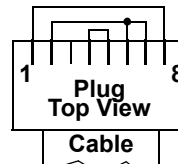

The RS-232 loopback plug also works for RS-422.

Note: You can use Test Terminal (Windows) or minicom (Linux) to test the serial port. You can refer to [Testing Ports Using Test Terminal](#) on Page 162 for Windows systems or [ftp://ftp.comtrol.com/html/troubleshooting.htm#linux](http://ftp.comtrol.com/html/troubleshooting.htm#linux) list for Linux systems.

RJ45 RS-485 Test Cable

You can use a straight-through cable as illustrated previously, or build your own cable.

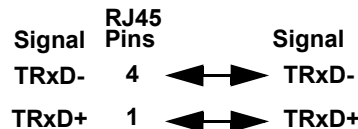

Note: RS-422 pinouts are not standardized. Each peripheral manufacturer uses different pinouts. Please refer to the documentation for the peripheral to determine the pinouts for the signals above.

Connecting RJ45 Devices

You can use this information to connect serial devices to RJ45 connectors.

Note: This does not include products that use DB9 to RJ45 adapters.

1. Connect your serial devices to the appropriate serial port on the DeviceMaster using the appropriate cable.

Note: Refer to the hardware manufacturer's installation documentation if you need help with connector pinouts or cabling for the peripheral device.

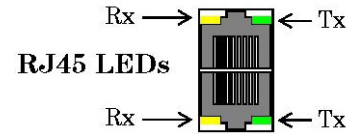

2. If the DeviceMaster has RX/TX LEDs, verify that the devices are communicating properly.

The RX (yellow) and TX (green) LEDs function accordingly when the cable is attached properly to a serial device.

- After power cycling the DeviceMaster, the RX/TX LEDs are off.
- The LEDs do not function as described until the port has been opened by an application. You can use Test Terminal to open a port or ports if you want to test a port or ports ([Testing Ports Using Test Terminal](#) on Page 162).
 - If the port is configured for RS-232/422 mode:
 - RX LEDs (yellow) are lit
 - TX LEDs (green) are lit when as the data exits the port
 - If the port is configured for RS-485 mode:
 - RX LEDs (yellow) are lit while receiving
 - TX LEDs (green) are lit during active data transmission
- 3. You can refer to [Network and Device LEDs](#) on Page 175 for information about the remaining LEDs.

Serial Terminals (4) - 1E

This subsection discusses the following topics for the DeviceMaster 2-port 1E with serial terminals (4). See [Serial Terminals \(8\) - 2E](#) on Page 104 if the DeviceMaster has eight serial terminals.

- [Serial Terminal \(4\) Connectors](#) on Page 101
- [Serial Terminal \(4\) Null-Modem Cables \(RS-232\)](#) on Page 102
- [Serial Terminal \(4\) Null-Modem Cables \(RS-422\)](#) on Page 102
- [Serial Terminal \(4\) Straight-Through Cables \(RS-232/485\)](#) on Page 102
- [Serial Terminal \(4\) Loopback Signals](#) on Page 103
- [Connecting Serial Devices](#) on Page 103

Serial Terminal (4) Connectors

Use the following table or drawings for signal information. The signals for SERIAL2 are the same as SERIAL1.

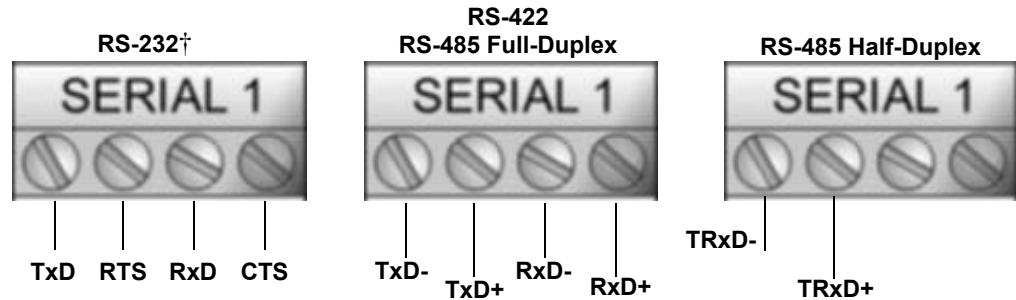

† RS-232 ground must be connected to the appropriate signal ground

RS-232: Connecting the Ground

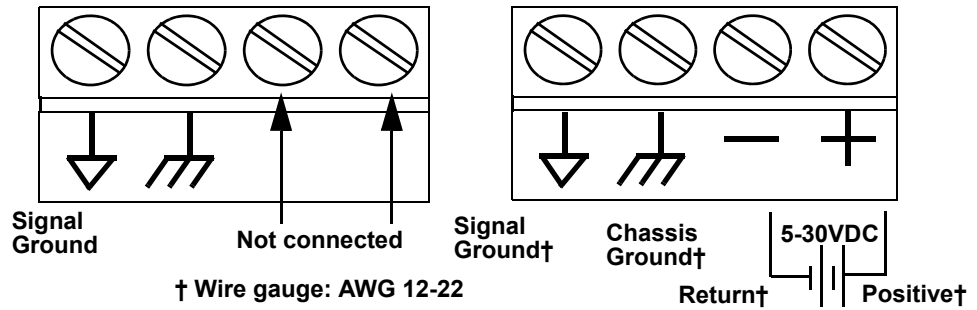

RS-232†	TxD	RTS	RxD	CTS
RS-422/RS-485 Full-Duplex	TxD-	TxD+	RxD-	RxD+
RS-485 Half-Duplex	TRxD-	TRxD+		

† RS-232 ground must be connected to the appropriate signal ground terminal.

Serial Terminal (4) Null-Modem Cables (RS-232)

An RS-232 null-modem cable is required for connecting DTE devices.

RS-232 Null-Modem Cable

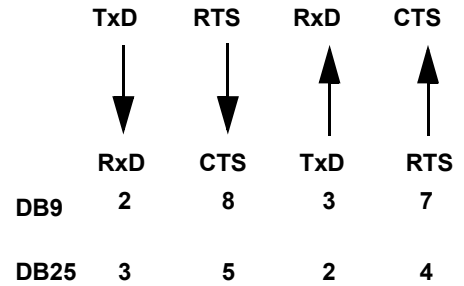
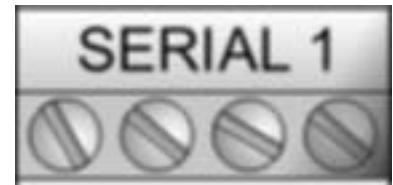

Serial Terminal (4) Null-Modem Cables (RS-422)

An RS-422 null-modem cable is required for connecting DTE devices.

Note: RS-422 pinouts are not standardized. Each peripheral manufacturer uses different pinouts. Please refer to the documentation for the peripheral to determine the pinouts for the signals above.

RS-422 Null-Modem Cable

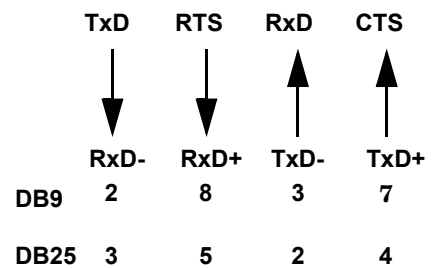
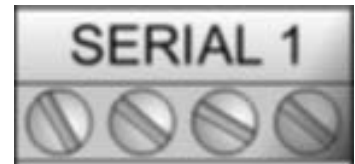

Serial Terminal (4) Straight-Through Cables (RS-232/485)

RS-232 or RS-485 straight-through cables are used to connect modems and other DCE devices.

RS-232/422 Straight-Through Cable

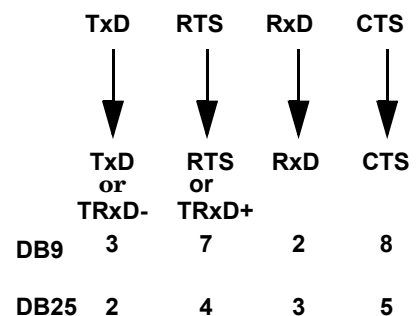
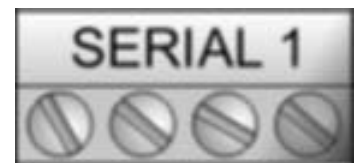

Serial Terminal (4) Loopback Signals

Use this drawing to wire a loopback, which is used in conjunction with application software (Test Terminal for Windows or minicom for Linux) to test serial ports.

Wire the terminals together to create a loopback.

- TxD to RxD
- RTS to CTS

Note: You can use *Test Terminal* (Windows) or *minicom* (Linux) to test the serial port. You can refer to [Testing Ports Using Test Terminal](#) on Page 162 for Windows systems or ftp://ftp.control.com/html/troubleshooting.htm#linux_list for Linux systems.

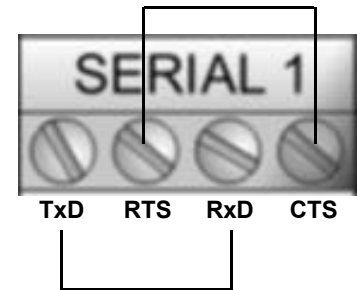

Connecting Serial Devices

Use the following information to connect the DeviceMaster 2-port 1E with serial terminals.

1. Connect your serial devices to the appropriate serial port on the DeviceMaster using the appropriate cable. You can build your own cables or loopbacks using the appropriate discussions.

Note: Refer to the hardware manufacturer's installation documentation if you need help with connector pinouts or cabling for the serial device.

2. You can refer to [Network and Device LEDs](#) on Page 175 for information about the LEDs.

Serial Terminals (8) - 2E

This subsection discusses the following topics for the DeviceMaster 2-port 2E with serial terminals (8).

- [Serial Terminal \(8\) Connectors](#) on Page 104
- [Serial Terminal \(8\) Null-Modem Cables \(RS-232\)](#) on Page 105
- [Serial Terminal \(8\) Null-Modem Cables \(RS-422\)](#) on Page 105
- [Serial Terminal \(8\) Straight-Through Cables \(RS-232/485\)](#) on Page 105
- [Serial Terminal \(8\) Loopback Signals](#) on Page 106
- [Connecting Serial Devices](#) on Page 106

Serial Terminal (8) Connectors

Use the following drawings or table for signal information. The signals for SERIAL2 are the same as SERIAL1.

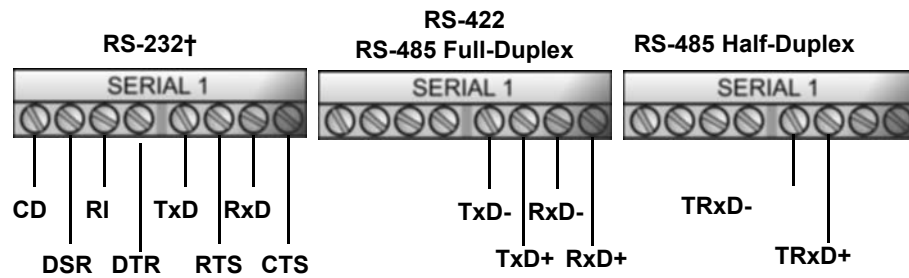

† RS-232 ground must be connected to the appropriate signal ground terminal.

RS-232: Connecting the Ground

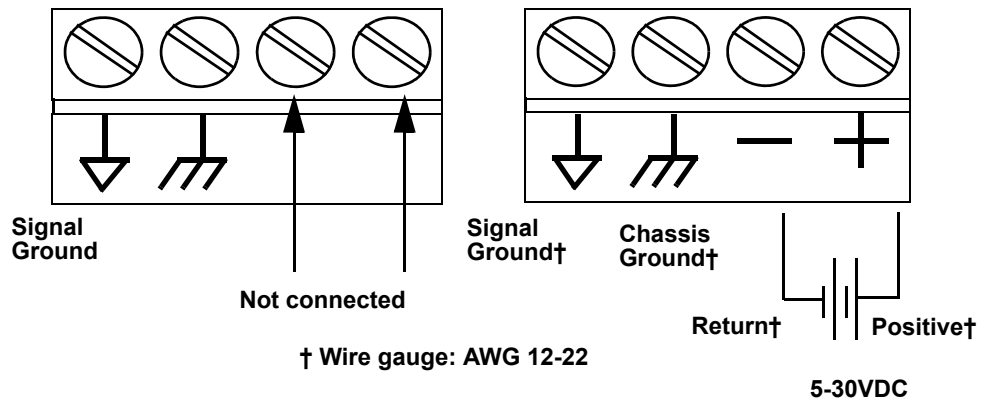

RS-232	CD	DSR	RI	DTR	TxD	RTS	RxD	CTS
RS-422/RS-485 Full-Duplex	N/A	N/A	N/A	N/A	TxD-	TxD+	RxD-	RxD+
RS-485 Half-Duplex	N/A	N/A	N/A	N/A	TRxD-	TRxD+	N/A	N/A

† RS-232 ground must be connected to the appropriate signal ground terminal.

Serial Terminal (8) Null-Modem Cables (RS-232)

An RS-232 null-modem cable is required for connecting DTE devices.

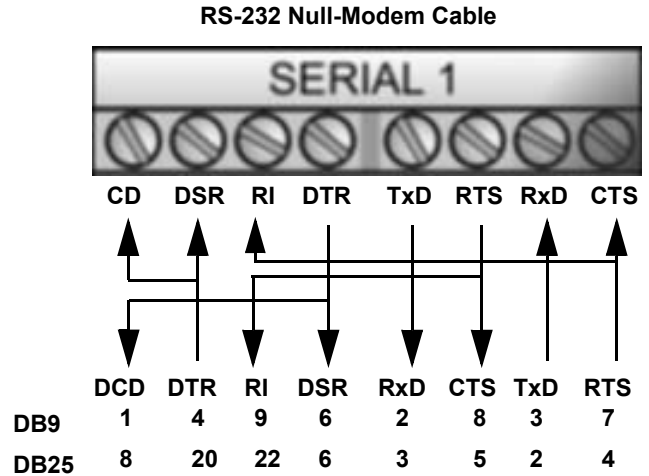

Serial Terminal (8) Null-Modem Cables (RS-422)

An RS-422 null-modem cable is required for connecting DTE devices.

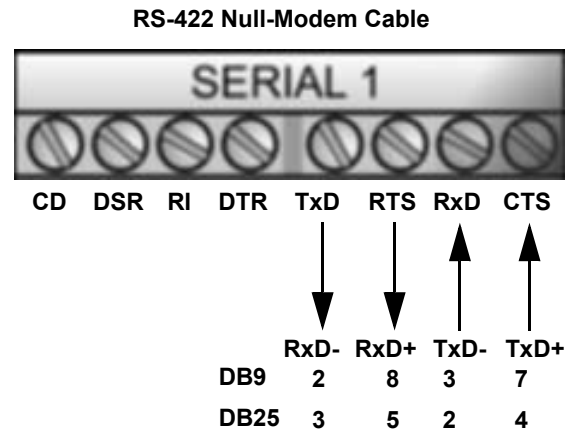

Serial Terminal (8) Straight-Through Cables (RS-232/485)

RS-232 or RS-485 straight-through cables are used to connect modems and other DCE devices.

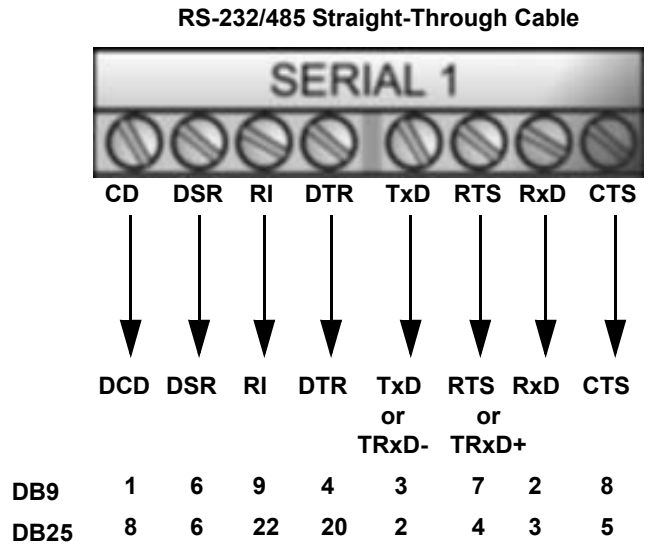

Serial Terminal (8) Loopback Signals

Use the drawing below to wire a loopback, which is used in conjunction with application software (Test Terminal or minicom) to test serial ports.

Wire the terminals together to create a loopback.

- TxD to RxD
- RTS to CTS to RI
- DTR to CD to DSR

Note: You can use Test Terminal (Windows) or minicom (Linux) to test the serial port. You can refer to [Testing Ports Using Test Terminal](#) on Page 162 for Windows systems or ftp://ftp.comtrol.com/html/troubleshooting.htm#linux_list for Linux systems.

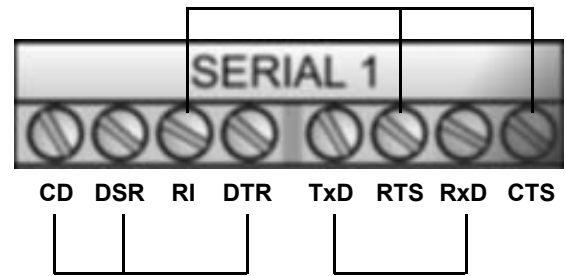

Connecting Serial Devices

Use the following information to connect the DeviceMaster 2-port 2E with serial terminals.

1. Connect your serial devices to the appropriate serial port on the DeviceMaster using the appropriate cable.

Note: Refer to the hardware manufacturer's installation documentation if you need help with connector pinouts or cabling for the serial device.

2. You can refer to [Network and Device LEDs](#) on Page 175 for information about the LEDs.

Managing the DeviceMaster

This section discusses the following DeviceMaster maintenance procedures:

- [Rebooting the DeviceMaster](#)
 - [Updating Firmware Across WANs \(Windows\)](#) on Page 108
 - [Uploading SocketServer to Multiple DeviceMasters](#) on Page 113
 - [Configuring Multiple DeviceMasters Network Addresses](#) on Page 115
- Note:** You can configure the network addresses for multiple DeviceMasters, configure common settings for the DeviceMasters, and save the settings to a configuration file that you can use to load settings up to all or selected DeviceMasters.
- [Adding a New Device](#) on Page 115
 - [Using SocketServer Configuration Files](#) on Page 117
 - [Using Driver Configuration Files](#) on Page 119
 - [Changing the Bootloader Timeout](#) on Page 124, which discusses changing the Bootloader timeout
 - [Managing Bootloader](#) on Page 128, which also discusses checking the Bootloader version and downloading the latest Bootloader
 - [Checking the NS-Link Version](#) on Page 130
 - [Restoring Factory Defaults \(2-Port, Only\)](#) on Page 131
- Note:** You can optionally refer to [RedBoot Procedures](#) on Page 133 if you want to perform procedures at the RedBoot level.

Rebooting the DeviceMaster

There are many ways to reboot the DeviceMaster. Use the method that most fits your situation.

Method	Procedure
PortVision DX	Right-click the DeviceMaster or DeviceMasters in the <i>Device List</i> pane, click Advanced >Reboot and then Yes . Note: If security has been enabled in the web page, you will need to reboot the DeviceMaster in the web page.
Web page	<i>Main page (Server Status):</i> Scroll to the bottom of the page, click Reboot and then Yes: Reboot .
Telnet	Type reset .
DeviceMaster 2-Port Models	DeviceMaster 2-port models have a Reset/Restore switch. <ul style="list-style-type: none">• If the Reset/Restore switch is depressed for less than 2 seconds, DeviceMaster RTS 2-port models reboot.• If the Reset/Restore switch is depressed for greater than approximately 5 seconds it restores the default password and network setting values.

Optionally, you can power cycle the DeviceMaster.

Updating Firmware Across WANs (Windows)

Use this procedure to update SocketServer with PortVision DX using a TFTP server. If you have a TFTP server installed, skip to [Step 2](#).

This procedure is also recommended in cases where SocketServer fails to load using convention methods.

1. If you do not have a TFTP server, you can download the appropriate one for your Windows operating system from the Comtrol ftp site.

ftp://ftp.comtrol.com/contribs/utilities/3rd_party_utils_free/tftp_server



Note: Depending on your Windows operating system, you may need to respond to a Security Warning popup.

- a. Unzip the tftp server that you downloaded to your host system in a location that you can easily find.
- b. Execute the **tftp.64.exe** (or **tftp32.exe**) file.
- c. Click **Run**.

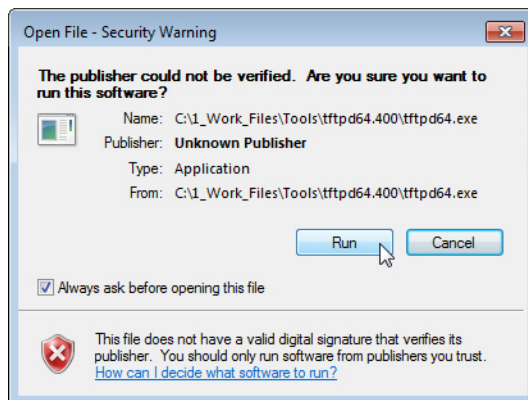

- d. Depending on your operating system, you may need to click **Unblock**, if you receive a *Windows Security Alert* popup.

The **Tftpd** application opens:

2. Make sure that you have downloaded the latest **SocketServer** version from:

[ftp://ftp.comtrol.com/
dev_mstr/rtS/software/
socketserver](ftp://ftp.comtrol.com/dev_mstr/rtS/software/socketserver).

You may want to place **SocketServer** in the same directory as the **Tftpd** server.

3. Optionally, rename the **SocketServer-x.xx.bin** file (where *x.xx* is the version number) to **1.bin** to make the following steps easier.
4. If necessary, open PortVision DX: **Start >Program > Control > PortVision DX > PortVision DX** or the desktop shortcut.
5. Change the **Bootloader Timeout** value to 60 seconds using one of these methods, depending on your **SocketServer** version ([greater than 9.10](#) or [less than 9.10](#)).

- **SocketServer versions greater than 9.10**

- a. Right-click the **DeviceMaster** in the *Device List* pane for which you want to upload the latest **SocketServer** and click **Properties**.
- b. Change the **Bootloader Timeout** value to 60, click **Apply Changes**, and then **Close**.

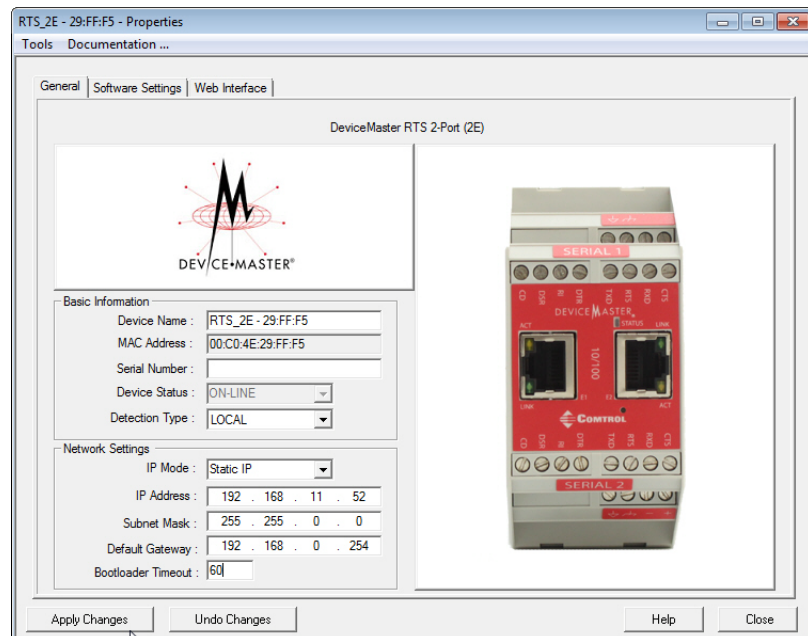
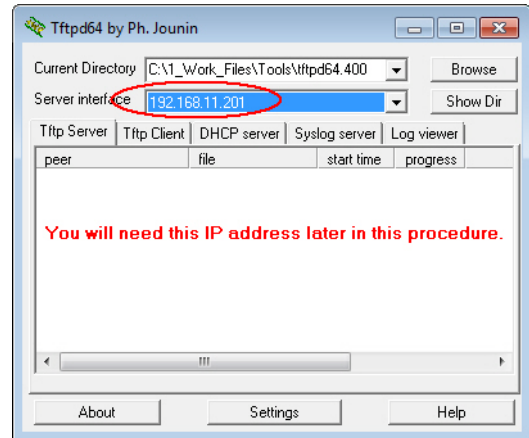

- c. Go to [Step 6](#).

- **SocketServer versions less than 9.10**

- Right-click the DeviceMaster in the *Device List* pane for which you want to upload the latest SocketServer and click **Telnet/SSH Session**.

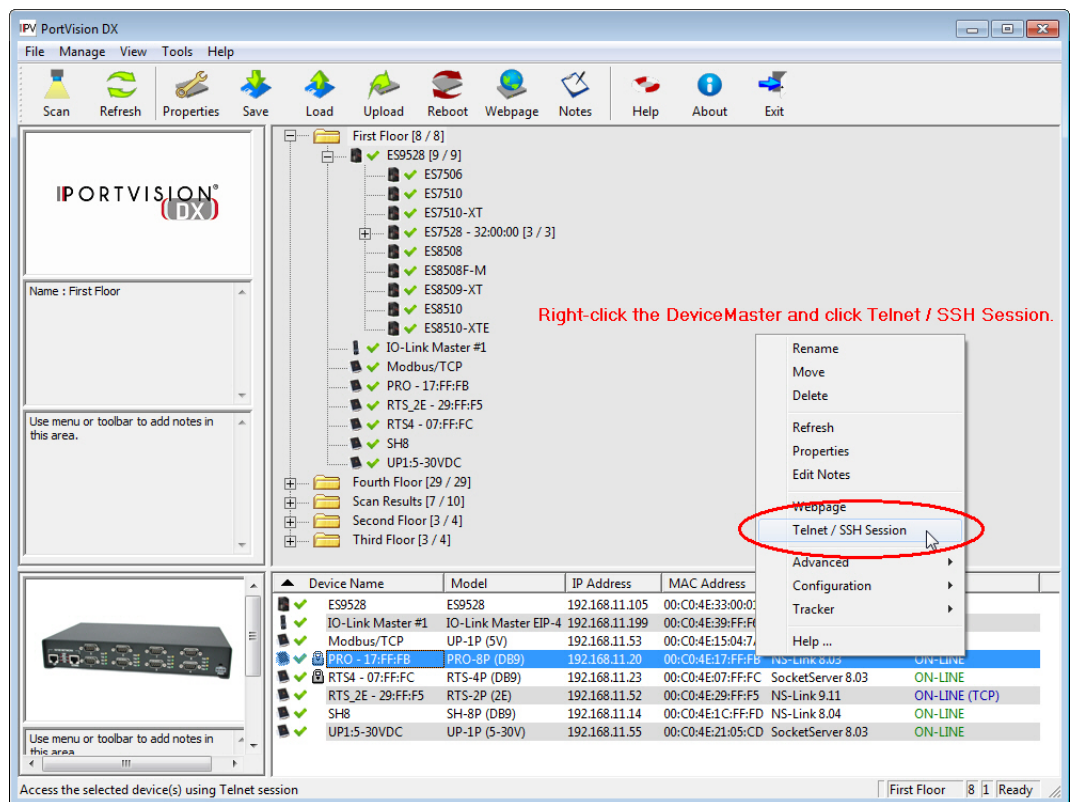

- Click **Telnet**, leave Port 23 as the *Selected Port* and click **Ok**.

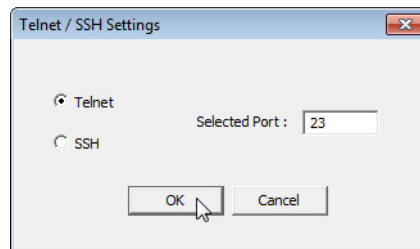

- If you have not set up a password, press **Enter** when the PuTTY screen appears or type the password and then press **Enter**.

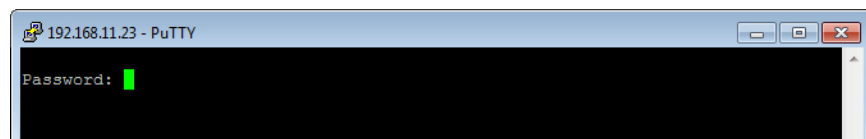

Note: If the PuTTY screen flashes in the background and does not appear as shown above, make sure that **Enable Telnet/ssh** has not been disabled in SocketServer. To check this, return to PortVision DX, right-click the DeviceMaster in the Device List pane, and click **Webpage**. Click the **Security** tab and if necessary, verify that the **Enable Telnet/ssh** option is enabled. If it is not, click the option and then click **Save**, and close SocketServer. Repeat [Step b](#) (above).

- d. At the **dm>** prompt, enter **timeout 60** and press **Enter**.

```

192.168.11.23 - PuTTY
Password:
Control DeviceMaster RTS ModelID: 5002111
SocketServer 8.03
Built: Wed May 30 14:17:47 CDT 2012
IP Addr: 192.168.11.23, Mask: 255.255.0.0, Gateway: 192.168.11.1
MAC Addr: 00:c0:4e:07:ff:fc

dm> timeout 60
Timeout 60 seconds

dm> █
    
```

- e. At the **dm>** prompt, enter **reset** and press **Enter**, which reboots DeviceMaster.

```

192.168.11.23 - PuTTY
Password:
Control DeviceMaster RTS ModelID: 5002111
SocketServer 8.03
Built: Wed May 30 14:17:47 CDT 2012
IP Addr: 192.168.11.23, Mask: 255.255.0.0, Gateway: 192.168.11.1
MAC Addr: 00:c0:4e:07:ff:fc

dm> timeout 60
Timeout 60 seconds

dm> reset █
    
```

- f. Close the PuTTY session.

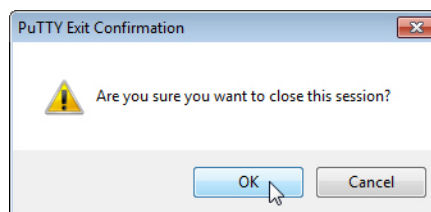

- In PortVision DX, right-click the DeviceMaster in the *Device List* pane for which you want to upload the latest SocketServer. and click **Telnet/SSH Session**.

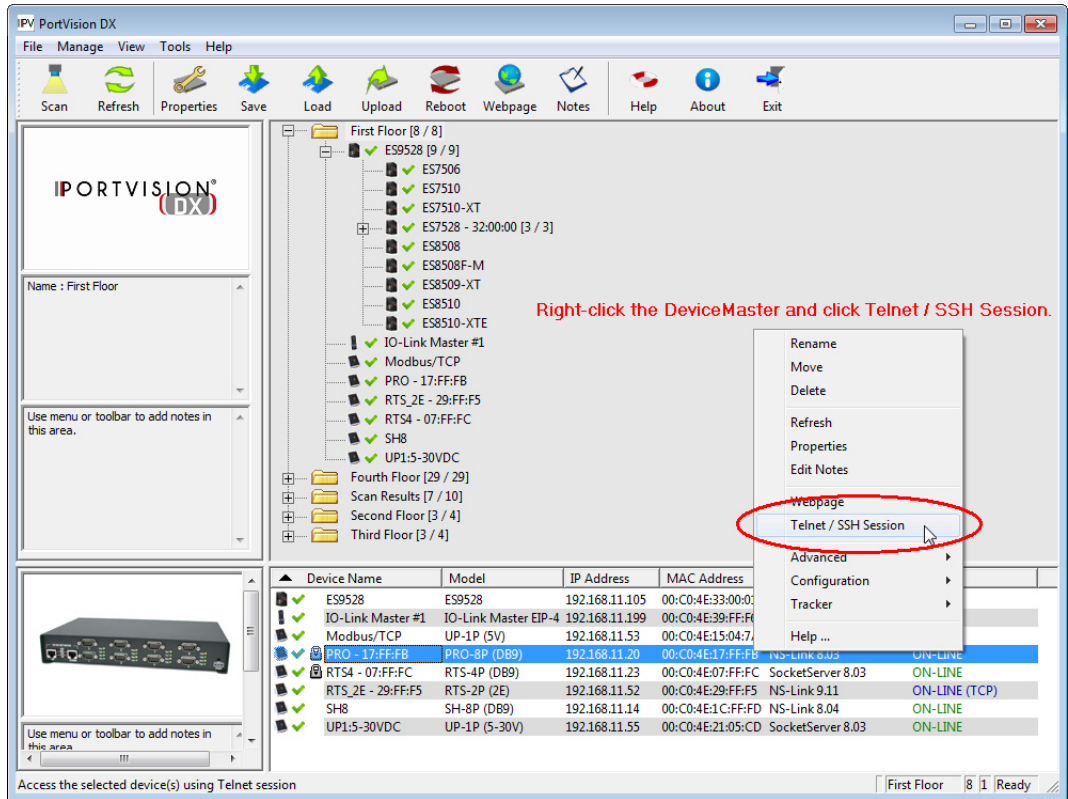

- Leave the popup set to **Telnet** and **Selected Port 23**, and click **Ok**.

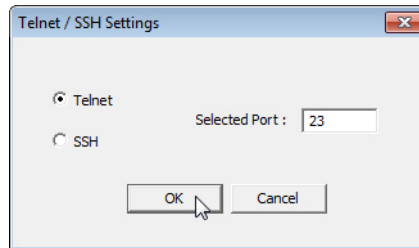

- Make sure that the Bootloader version number displays with the **RedBoot>** prompt.

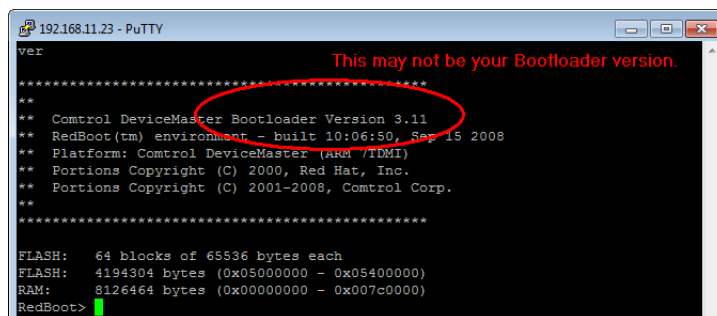

If the **RedBoot>** prompt does not appear, reboot the DeviceMaster and try again. You must be at the **RedBoot>** prompt for the following steps to work. Repeat [Steps 6](#) through 7.

9. At the **RedBoot**> prompt, enter **dis** and press **Enter**.

Note: Make sure that loading is disabled before performing the next step.

10. Enter the following command:

```
load -r -b 0 -h <tftp-Server_IP_Address> <Downloaded_File_Name>
```

Note: Zero is the character between the *-b* and *-h*. The *tftp-Server_IP_Address* can be viewed in the application (Page 109) and if you renamed the file as suggested, the file name is *1.bin*.

11. At the **RedBoot**> prompt, type **go** after the *raw* file string appears.

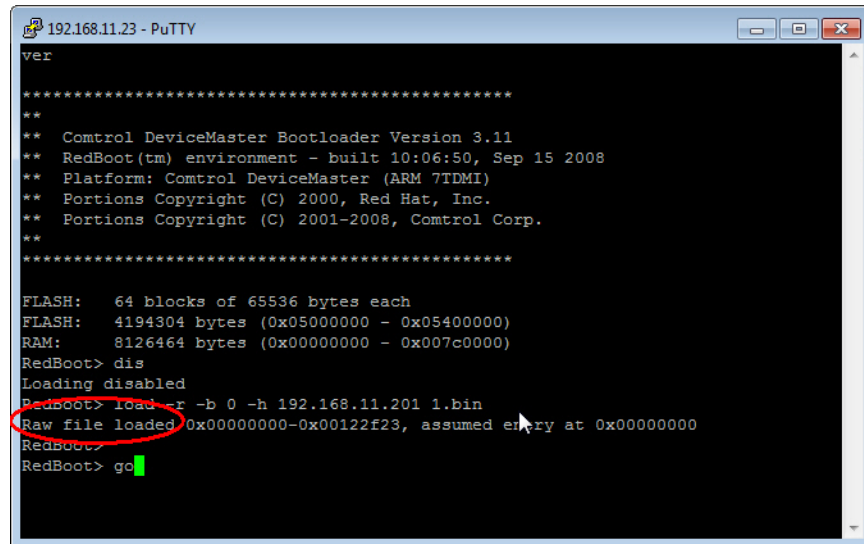

12. Close the PuTTY window and click **Ok**.

13. In PortVision DX, highlight the DeviceMaster in the *Device List* pane that you updated and click **Refresh**. You may need to click **Refresh** several times before you see the latest SocketServer version listed under the *Software Version*.

Uploading SocketServer to Multiple DeviceMasters

If an older version of the NS-Link driver for Windows (before v9.xx) has been installed, make sure that the driver is disabled through the *Device Manager* before uploading SocketServer.

You can use this procedure if your DeviceMaster is connected to the host PC, laptop, or if the DeviceMaster resides on the local network segment.

1. If you have not done so, install PortVision DX ([Installing PortVision DX](#) on Page 37) and **Scan** the network.
2. Shift-click the multiple DeviceMasters on the **Main** screen that you want to update and use one of the following methods:
 - Click the **Upload** button.
 - Right-click and then click **Advanced > Upload Firmware**.

- Click **Advanced > Upload Firmware** in the **Manage** menu.

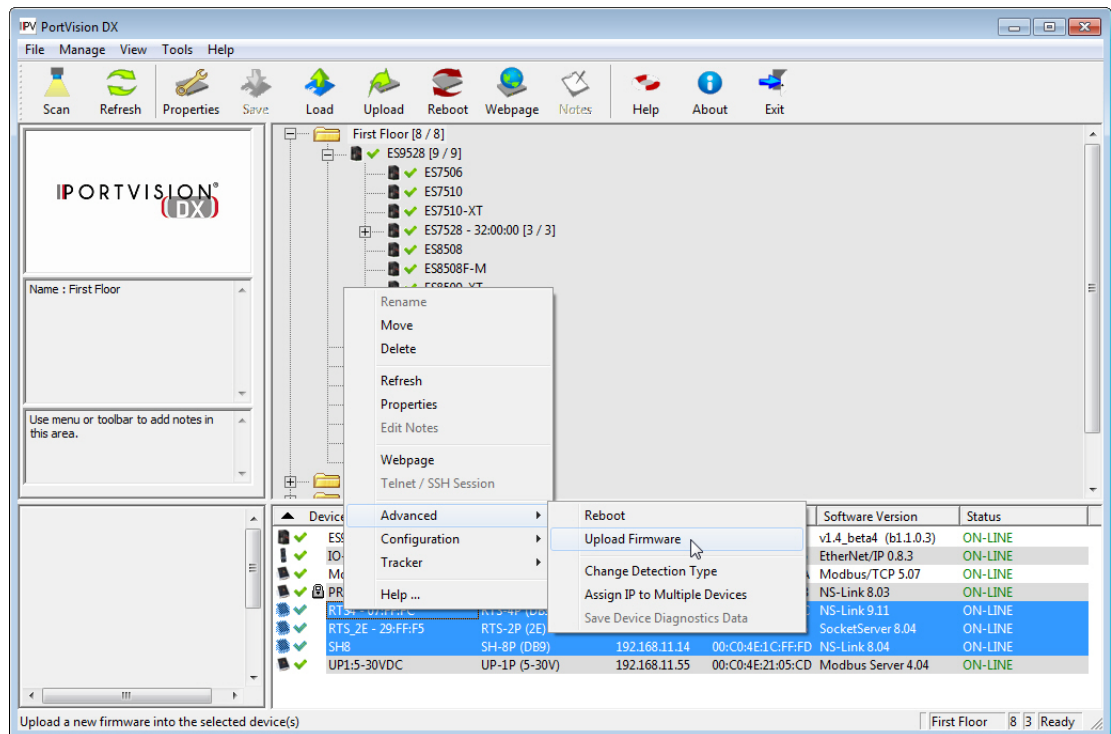

3. Browse, click the firmware (.bin) file, **Open** (*Please locate the new firmware*), and then click **Yes** (*Upload Firmware*).

It may take a few moments for the firmware to upload onto the DeviceMaster. The DeviceMaster reboots itself during the upload process.

4. Click **Ok** to the advisory message about waiting to use the device until the status reads **ON-LINE**.

In the next polling cycle, PortVision DX updates the *Device List* pane and displays the new firmware version.

Configuring Multiple DeviceMasters Network Addresses

You can configure the network addresses for multiple DeviceMasters using the **Assign IP to Multiple Devices** option.

In addition, you can also configure common settings for the DeviceMaster SocketServer or NS-Link web page and save the settings to a configuration file that you can load to all or selected DeviceMasters. See [Using SocketServer Configuration Files](#) on Page 117 for more information.

The DeviceMasters must be on the same network segment for this procedure to work. Use the following steps to configure multiple DeviceMasters.

1. If you have not done so, install PortVision DX ([Installing PortVision DX](#) on Page 37) and **Scan** the network.
2. Shift-click the DeviceMasters for which you want to program network information, right-click, and click **Advanced > Assign IP to Multiple Devices**.
3. Enter the starting IP address, subnet mask, IP Gateway and click **Proceed**.

PortVision DX displays the programmed IP addresses in the *Device List* pane after the next refresh cycle.

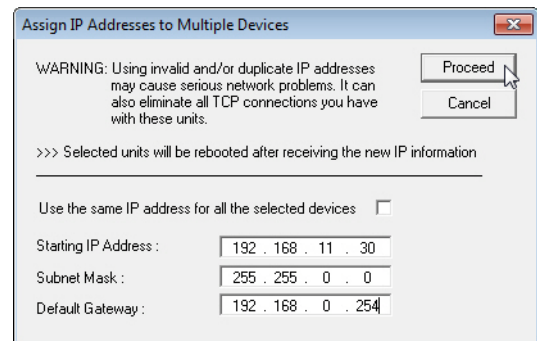

Adding a New Device

You can add a new DeviceMaster manually, if you do not want to scan the network to locate and add new DeviceMasters, but there may be cases where you want to use the *Add New Device* window to:

- Configure DeviceMaster units that are not on the local network (remote) using [Remote Using the IP Address](#) on Page 115.
- Pre-configure a DeviceMaster in PortVision DX (local) using [Local Using the IP Address or MAC Address](#) on Page 116.

Remote Using the IP Address

Use the following procedure to add a remote DeviceMaster to PortVision DX.

1. Access the *New Device* window using one of these methods:
 - Click **Add New > Device** in the *Manage* menu.
 - Right-click a folder or a RocketLinx switch in the *Device Tree* pane (anywhere in the pane, as long as a DeviceMaster is not highlighted and you are in a valid folder) and click **Add New > Device**.
2. Select the appropriate DeviceMaster in the **Device Type** drop list.
3. Select the appropriate model in the **Device Model** drop list.
4. Enter a friendly device name in the **Device Name** list box.
5. Select **REMOTE** for the *Detection Type*.
6. Optionally, enter the serial number in the **Serial Number** list box.

7. Enter the IP Address for the DeviceMaster. It is not necessary to enter the , Subnet Mask and Default Gateway

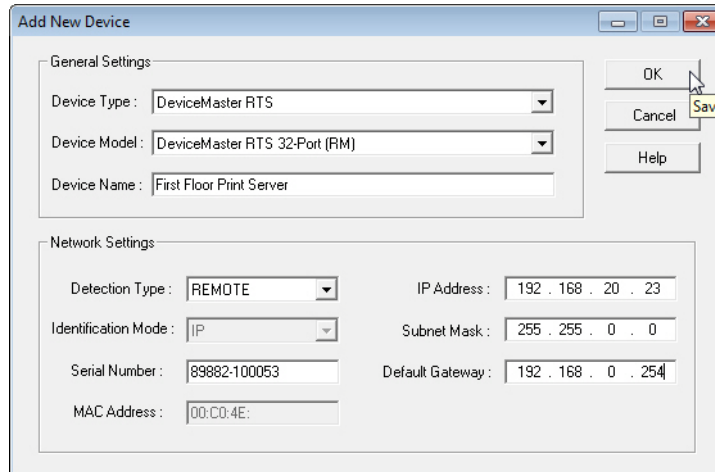

8. Click **Ok** to close the *Add New Device* window. It may take a few moments to save the DeviceMaster.
9. If necessary, click **Refresh** for the new DeviceMaster to display in the *Device Tree* or *Device List* panes. The DeviceMaster shows OFF-LINE if it is not attached to the network or if an incorrect IP address was entered.

Local Using the IP Address or MAC Address

Use the following procedure to add a local DeviceMaster to PortVision DX if you do not want to scan the network.

1. Locate the network information or MAC address of the DeviceMaster you want to add.
2. Access the *New Device* window using one of these methods:
 - Click **Add New > Device** in the *Manage* menu.
 - Right-click a folder or a RocketLinx switch in the *Device Tree* pane (anywhere in the pane, as long as a DeviceMaster is not highlighted and you are in a valid folder) and click **Add New > Device**.
3. Select the appropriate DeviceMaster in the **Device Type** drop list.
4. Select the appropriate model in the **Device Model** drop list.
5. Enter a friendly device name in the **Device Name** list box.
6. Select **LOCAL** for the *Detection Type*.
7. Enter the MAC address or network information.

Note: A MAC address label is attached to all DeviceMaster units. The first three pairs of digits start with 00 C0 4E.

8. Optionally, enter the serial number in the **Serial Number** list box.

9. Click **Ok**.
10. If necessary, click **Refresh** for the new DeviceMaster to display in the *Device Tree* or *Device List* panes. The DeviceMaster shows OFF-LINE if it is not attached to the network or if an incorrect IP address was entered.

Using SocketServer Configuration Files

If you are deploying multiple DeviceMaster units that share common SocketServer values, you can save the configuration file (.dc) from the *Main* or **Properties > Software Settings** tab in PortVision DX and load that configuration onto other DeviceMaster units.

Note: Configuration files saved before SocketServer 9.xx cannot be loaded onto a DeviceMaster with SocketServer versions above 9.xx.

If you save a SocketServer configuration file from the *Main* or **Software Settings** tab on the *Properties* screen, you can choose what settings you want saved or loaded.

You may want to program the network settings in multiple DeviceMasters using [Configuring Multiple DeviceMasters Network Addresses](#) on Page 115.

PortVision Plus configuration files

Note: You can save device driver configuration settings if you have driver version 9.02 or higher. See [Using Driver Configuration Files](#) on Page 119 for procedures for saving and loading device driver configuration settings.

Saving a SocketServer Configuration File

Use this procedure to save a configuration file using the *Main* screen.

Note: Optionally, you can save a configuration file by accessing the **Software Settings** tab in the *Properties* screen and then clicking the **Save Settings to a File** button.

1. If you have not done so, install PortVision DX ([Installing PortVision DX](#) on Page 37) and **Scan** the network.
2. Highlight the DeviceMaster in the *Device List* pane that you want to save its configuration and use one of the following methods:
 - Click the **Save** button.
 - Right-click and then click **Configuration > Save**.
3. Browse to the location you want to save the file, enter a file name, and click **Save**.

4. Click the **All** check box or click only the properties that you want saved for each property page in the configuration file and click **Done**.
5. Click **Ok** to close the *Save Configuration Completed* message.

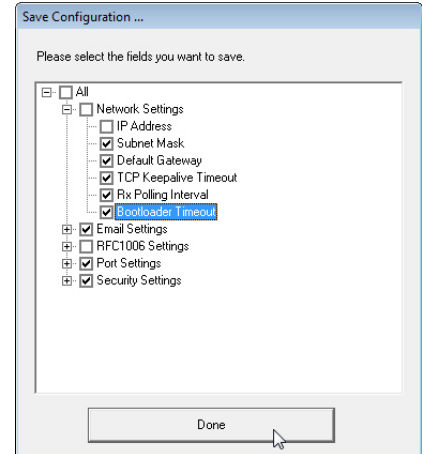

Loading a SocketServer Configuration File

Use the following procedure to load a previously saved a DeviceMaster configuration file. Load a configuration file and apply it to a selected DeviceMaster or DeviceMasters from the *Device List* pane or **Software Settings** tab on the *Properties* screen.

Note: Configuration files saved before SocketServer 9.xx cannot be loaded onto a DeviceMaster with SocketServer versions above 9.xx.

Use this procedure to load a configuration file using the *Device List* pane to one or more DeviceMaster units.

Note: The configuration file does not need to be the same model or port density. For example, the saved configuration file could be from a DeviceMaster PRO 8-port that you want to load on a DeviceMaster RTS 1-port.

1. Highlight the device or devices in the *Device List* pane that you want to load and use one of the following methods:
 - Click the **Load** button
 - Right-click and then click **Configuration > Load**
 - Click **Load Settings from a File** on the **Software Settings** tab of the *Properties* screen
2. Click **Yes** to the warning that it will take 25 seconds per device and it may also reboot the devices.
3. Browse to the location of the configuration file, click the file name (.dc) and then **Open**.
4. Click the **All** check box or click only the properties that you want to load for each property page in the configuration file and then click **Done**.

Note: If you click **All**, every selected DeviceMasters will be programmed with the same IP address.

5. Close the *Load Configuration* popup message.

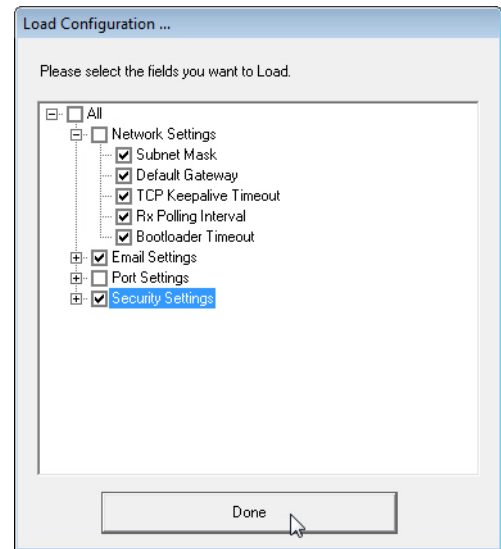

Using Driver Configuration Files

This subsection discusses how to create (save) and load driver configuration files. You may want to create driver configuration files for these reasons:

- Save the driver configuration settings so that you can load them on similar DeviceMasters to save configuration time
- Save the driver configuration settings because you need to remove a driver version to install a new driver version and you want to reload the driver configuration settings into the new driver

Device driver configuration files must be for the same model with the same port density. For example, you cannot load a DeviceMaster PRO configuration file onto a DeviceMaster RTS or a configuration file for a 32-port DeviceMaster RTS onto a 4-port DeviceMaster RTS.

Saving Driver Configuration Files

Use the following procedure to create and save a configuration file.

1. If necessary, open the *Control Drivers Management Console* using one of these methods:
 - **Windows Control Panel;** go to your *Control Panel* and click the **Control Drivers Management Console**.
 - **Shortcut;** located under **Start> Program Files> Control> DeviceMaster> Control Drivers Management Console**.
2. Depending on your operating system, you may need to click **Yes** to the *Do you want to allow the following program to make changes to this computer?* User Account Control message.
3. Highlight the DeviceMaster for which you want to save the driver configuration.
4. Click **Save Configuration**.

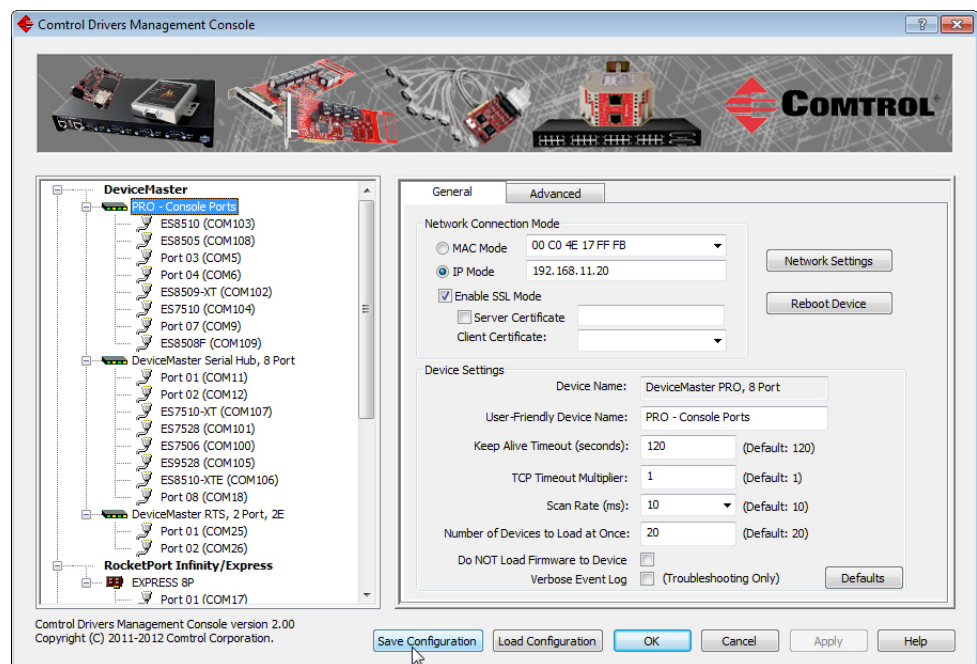

- Optionally, change the default file name and click **Save**.

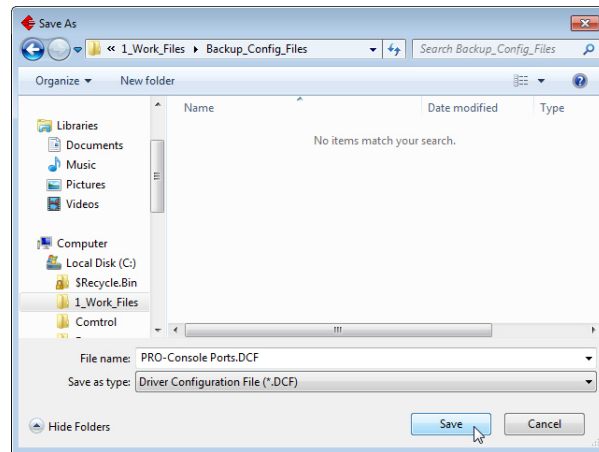

- Repeat the previous steps for each DeviceMaster for which you want to save the driver configuration.

Loading Driver Configuration Files

You must have previously saved a driver configuration file before you can load a configuration file.

The driver configuration file uploads in portions:

- Device-level configuration parameters.
- Port configuration parameters. You must upload each port's configuration parameters separately.

Loading Device Configuration

Use the following procedure to load the configuration file for device-level information for your DeviceMaster.

- If necessary, open the *Control Drivers Management Console* using one of these methods:
 - **Windows Control Panel**; go to your *Control Panel* and click on the **Control Drivers Management Console**.
 - **Shortcut**; located under **Start > Program Files > Control > DeviceMaster > Control Drivers Management Console**.
- Depending on your operating system, you may need to click **Yes** to the *Do you want to allow the following program to make changes to this computer?* User Account Control message.

- In the left pane, highlight the DeviceMaster for which you want to load the device-level settings from the configuration file.

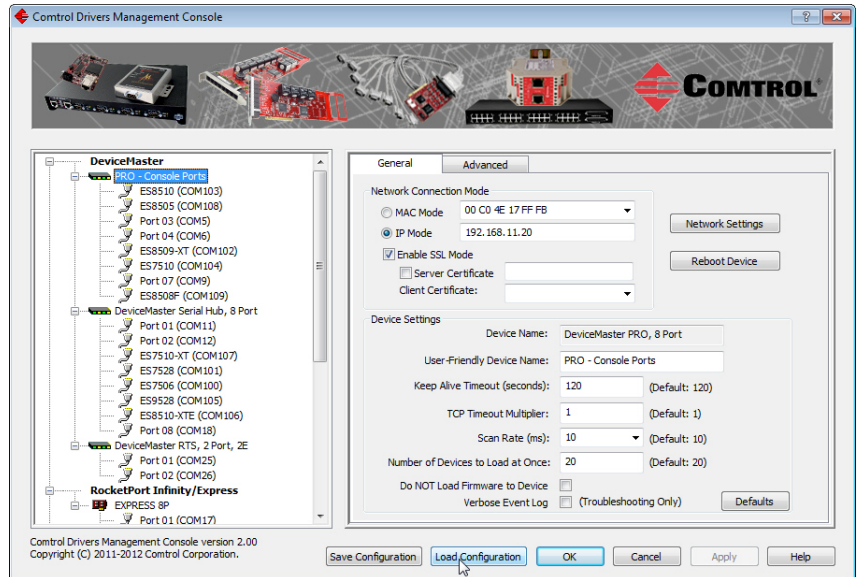

- Click **Load Configuration**.
- Browse to the location of the configuration file that you want to load.
- Highlight the configuration file and click **Open**. The configuration file loads in a few moments.

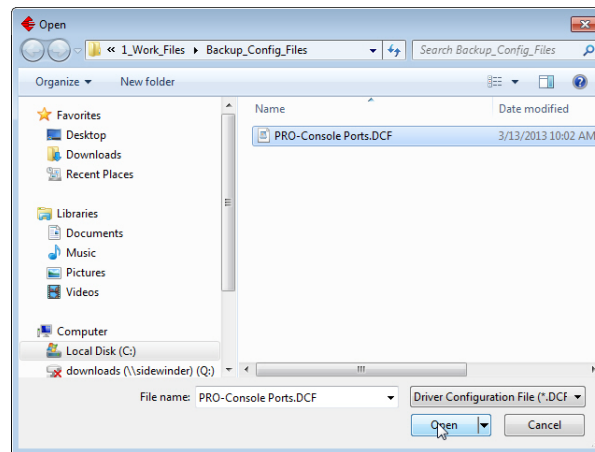

7. Make the appropriate choice for your situation:

- Click **No** to the *ControlApplet* message, if you are using the file to set up multiple DeviceMasters with the same device-level settings.
- Click **Yes** to the *ControlApplet* message, if you are using the file to restore a specific DeviceMaster. For example, you needed to remove and then re-install the DeviceMaster NS-Link device driver.

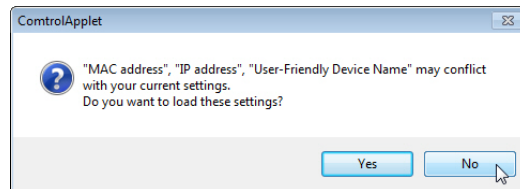

8. Click **Apply** so that the configuration is saved on the DeviceMaster.
9. Go to the next procedure if you want to restore port settings from a configuration file.

Loading Port Configuration

Use the following procedure to load the configuration file for port-level settings for your DeviceMaster.

Note: *Device driver configuration files must be for the same model with the same port density. For example, you cannot load a DeviceMaster PRO configuration file onto a DeviceMaster RTS or a configuration file for a 32-port DeviceMaster RTS onto a 4-port DeviceMaster RTS.*

1. If necessary, open the *Control Drivers Management Console* using one of these methods:
 - **Windows Control Panel;** go to your *Control Panel* and click on the **Control Drivers Management Console**.
 - **Shortcut;** located under **Start > Program Files > Control > DeviceMaster > Control Drivers Management Console**.
2. Depending on your operating system, you may need to click **Yes** to the *Do you want to allow the following program to make changes to this computer?* User Account Control message.
3. In the left pane, highlight the port for which you want to load the port-level settings from the configuration file.

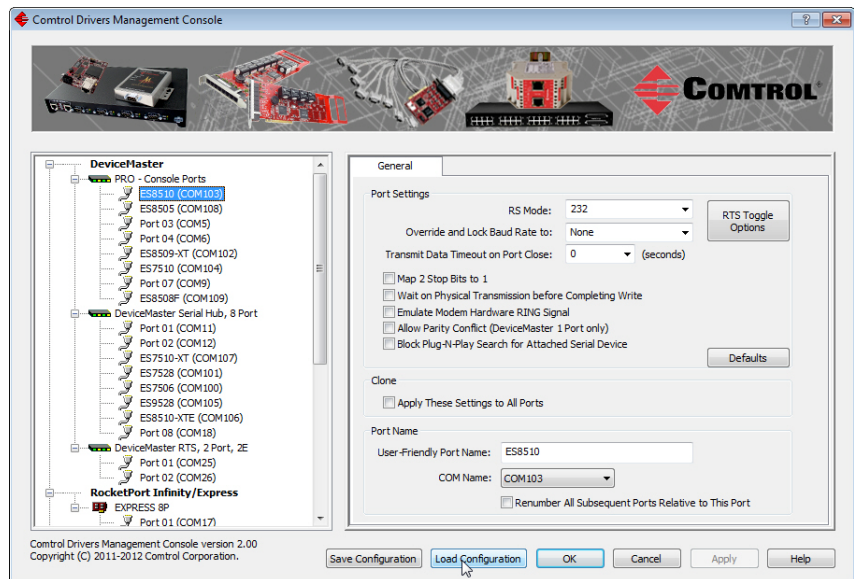

4. Click **Load Configuration**.

5. Browse to the location of the configuration file that you want to load.
6. Highlight the configuration file and click **Open**. The configuration file loads in a few moments.

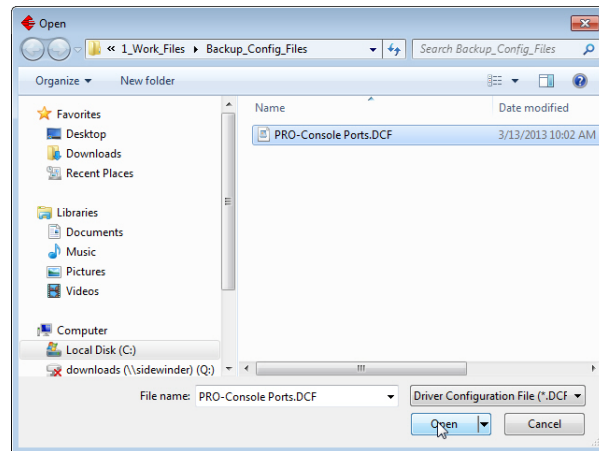

7. Make the appropriate choice for your situation:
 - Click **No** to the *ControlApplet* message, if you are using the file to set up multiple DeviceMasters with the same port-level settings.
 - Click **Yes** to the *ControlApplet* message, if you are using the file to restore a specific DeviceMaster. For example, you needed to remove and then re-install the DeviceMaster NS-Link device driver.

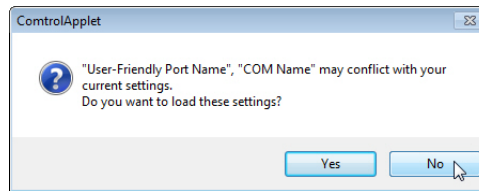

8. Click **Apply** so that the configuration is saved on the DeviceMaster.
9. Repeat [Steps 3](#) through 8 for each port that you want to restore.

Changing the Bootloader Timeout

If SocketServer fails during the upload process, you should change the **Bootloader timeout** value to 45 seconds.

Note: *The DeviceMaster must be able to communicate using an IP address, which is compatible with this local network. If necessary, refer to [Configuring the Network Settings](#) on Page 40.*

You can use one of the following procedures to change the Bootloader Timeout:

- [Properties Screen](#), which is the easiest method of changing the Bootloader timeout, if you meet these requirements:
 - NS-Link device driver assembly v10.xx or higher installed
 - SocketServer v9.xx or higher loaded on the DeviceMaster
 - PortVision DX installed
- [Network Web Page \(SocketServer 6.05 - 8.xx\)](#) on Page 125
- [Telnet/SSH Session \(SocketServer v6.04 and Below\)](#) on Page 127

Note: *You should return the Bootloader Timeout value back to 15 seconds after you upload SocketServer.*

Properties Screen

You must meet these requirement to use this procedure.

- NS-Link device driver assembly v10.xx or higher installed
- SocketServer v9.xx or higher loaded on the DeviceMaster
- PortVision DX installed

Note: *If you cannot meet these requirements, you can use the appropriate procedure in [Network Web Page \(SocketServer 6.05 - 8.xx\)](#) on Page 125 or [Telnet/SSH Session \(SocketServer v6.04 and Below\)](#) on Page 127.*

Use the following procedure to change the Bootloader timeout to 45 seconds. You can use this procedure to return the Bootloader timeout to 15 seconds after you have successfully uploaded SocketServer.

1. If necessary, start PortVision DX, from **Programs > Control > PortVision DX > PortVision DX**.
2. Right-click the DeviceMaster in the *Device Tree* or *Device List* pane and click **Properties**.

3. Type 45 in the **Bootloader Timeout** text box and click **Apply**.

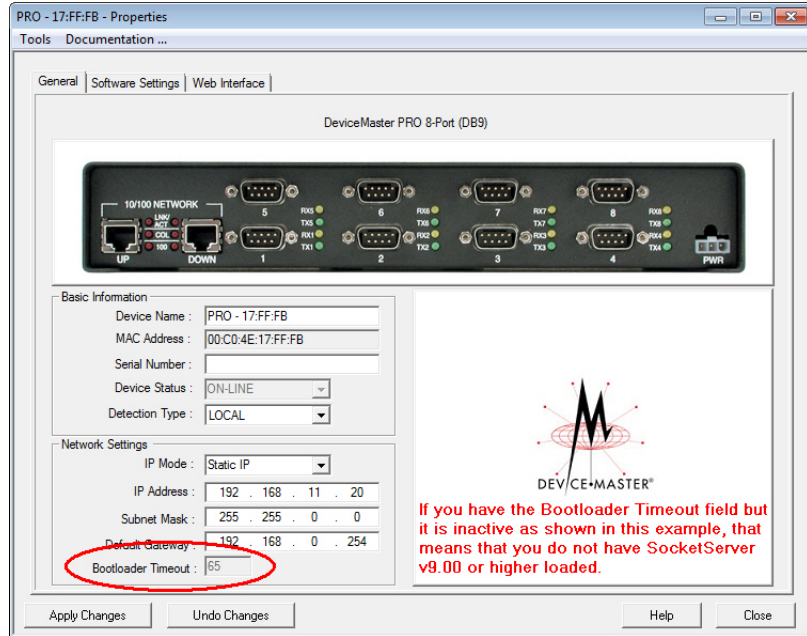

Network Web Page (SocketServer 6.05 - 8.xx)

You can use the following method to change the **Bootloader Timeout**.

1. Open your browser, enter the DeviceMaster IP address, and press **Enter**.
2. Click the **Configure Network** link.

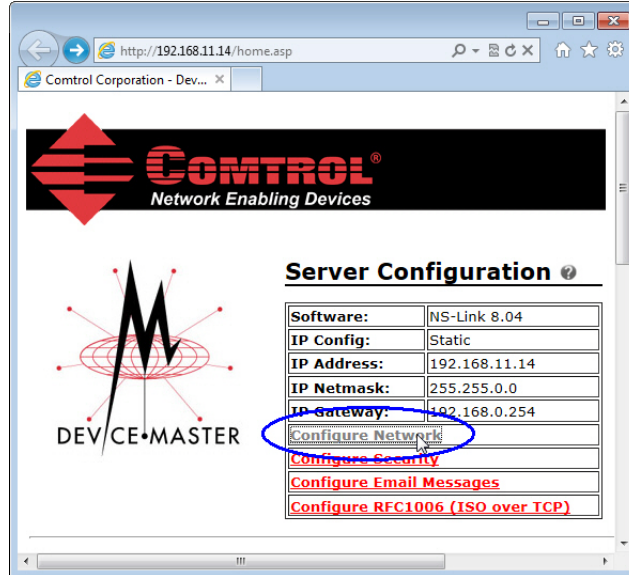

3. Type 45 in the **Bootloader Timeout** text box and click **Save**.

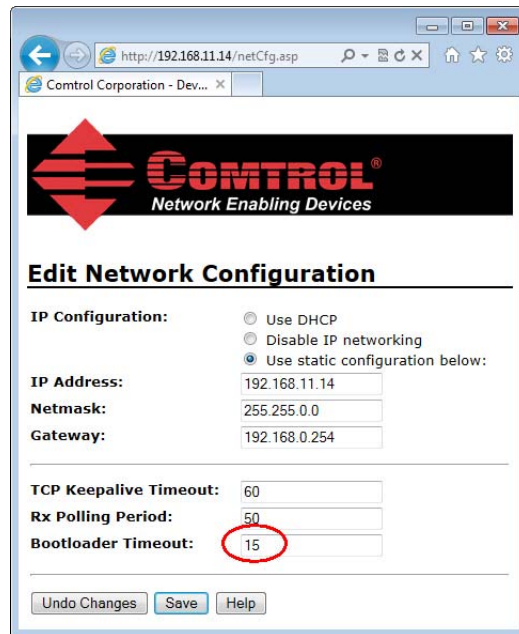

4. Click **Ok**.

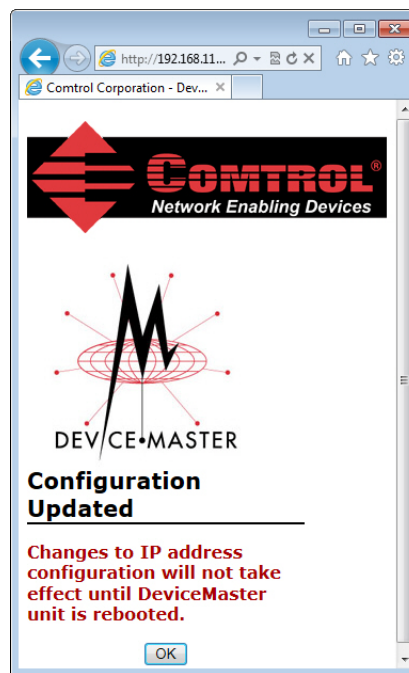

5. Make sure that you reset the **Bootloader Timeout** after uploading the firmware.

Telnet/SSH Session (SocketServer v6.04 and Below)

Use the following procedure to change the Bootloader timeout to 45 seconds. You can use this procedure to return the Bootloader timeout to 15 seconds after you have successfully uploaded SocketServer.

1. If necessary, start PortVision DX, from **Start > Programs > Control > PortVision DX > PortVision DX**.
2. Right-click the DeviceMaster in the *Device List* pane and click **Telnet/SSH Session**.

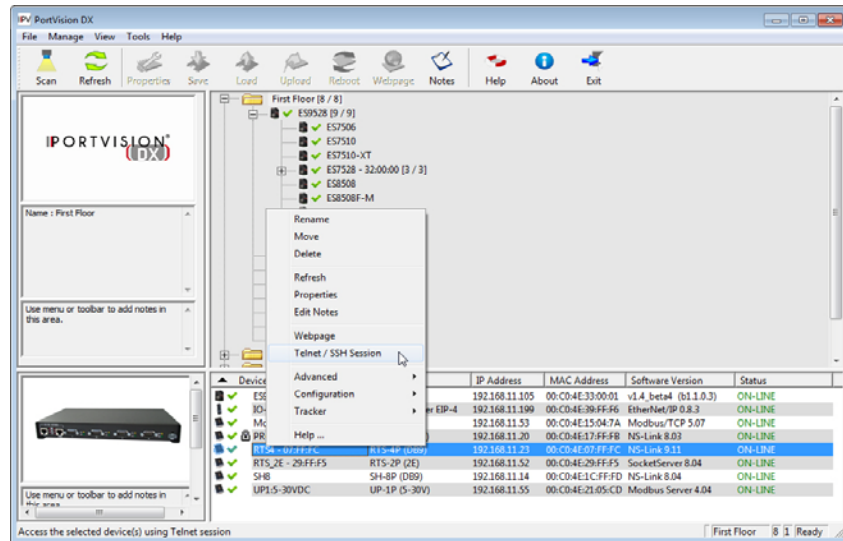

3. Click the **Telnet** radio button, leave **23** as the *Selected Port*, and click **Ok**.
4. If a password has been configured for the DeviceMaster, enter the password and press **Enter** or press **Enter** if no password has been configured.
5. Type **timeout** and press **Enter** to determine the existing *timeout* value.
6. Type **timeout 45** and press **Enter** to set the *timeout* to 45 seconds.

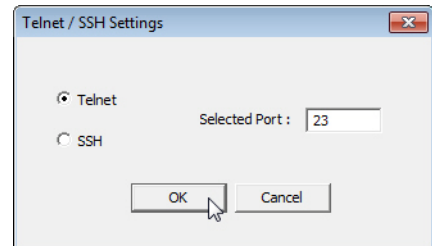

```

192.168.11.23 - PuTTY
ver
*****
**
** Control DeviceMaster Bootloader Version 3.11
** RedBoot(tm) environment - built 10:06:50, Sep 15 2008
** Platform: Comtrol DeviceMaster (ARM 7TDMI)
** Portions Copyright (C) 2000, Red Hat, Inc.
** Portions Copyright (C) 2001-2008, Comtrol Corp.
**
*****
FLASH: 64 blocks of 65536 bytes each
FLASH: 4194304 bytes (0x05000000 - 0x05400000)
RAM: 8126464 bytes (0x00000000 - 0x007c0000)
RedBoot> dis
Loading disabled
RedBoot> timeout
Timeout 15 seconds
RedBoot> timeout 45

```

7. Type **reset**, press **Enter**, close the window, and try to upload SocketServer again.

8. If SocketServer loads correctly, you can use the above procedure to reset the Bootloader *timeout* back to its default value of 15 seconds.

Managing Bootloader

Bootloader refers to the operating system that runs on the DeviceMaster hardware during the power on phase, which then loads SocketServer.

Note: *Typically, you should not update the Bootloader unless advised to do so by Control Technical Support.*

There are several methods and tools that you can use to check the Bootloader version or update the Bootloader.

- **PortVision DX** is the easiest way to check the Bootloader version and upload the latest version.
- Optionally, RedBoot can be used to check the Bootloader version and update the Bootloader. See [RedBoot Procedures](#) on Page 133 for procedures.

Checking the Bootloader Version

The following procedure uses PortVision DX to check the Bootloader version. Optionally, you can use RedBoot, see [Determining the Bootloader Version](#) on Page 137.

1. If you have not done so, install PortVision DX ([Installing PortVision DX](#) on Page 37) and **Scan** the network.
2. Right-click the DeviceMaster in the *Device List* pane and click **Advanced > Reboot**.
3. Click **Yes** to the *Confirm Reboot* query.
4. Right-click the DeviceMaster in the *Device List* pane, click **Refresh**. You may need to do this several times until you catch the reboot cycle in the *Device List* pane. The Bootloader version is briefly displayed during the reboot cycle before [SocketServer](#) loads.
5. Check the Control web site to see if a [later version](#) is available.
6. Go to the next subsection if you need upload a new version of Bootloader.

Uploading Bootloader

Use the following procedure to upload Bootloader to the DeviceMaster. Typically, you should not update the Bootloader unless advised to do so by Control Technical Support or a notice has been posted to the firmware download page on the ftp site.

Note: *Technical Support does not recommend updating Bootloader across a WAN. For best results, connect the DeviceMaster directly to a PC or laptop to upload Bootloader.*

Make sure that power is not interrupted while uploading Bootloader. Power interruption while uploading Bootloader will require that the DeviceMaster must be sent into Control so that it can be reflashed.

If you are not successful uploading SocketServer into the DeviceMaster, do not upload Bootloader.



If an older version of the NS-Link driver for Windows (before v9.xx) has been installed, make sure that the driver is disabled through the *Device Manager* before uploading Bootloader.

1. If you have not done so, install PortVision DX ([Installing PortVision DX](#) on Page 37) and **Scan** the network.
2. If necessary, check the Bootloader version ([Checking the Bootloader Version](#)) and download the latest version.

- Right-click the DeviceMaster for which you want to update, click **Advanced** > **Upload Firmware**, browse to the Bootloader .bin file, and then click **Open**.

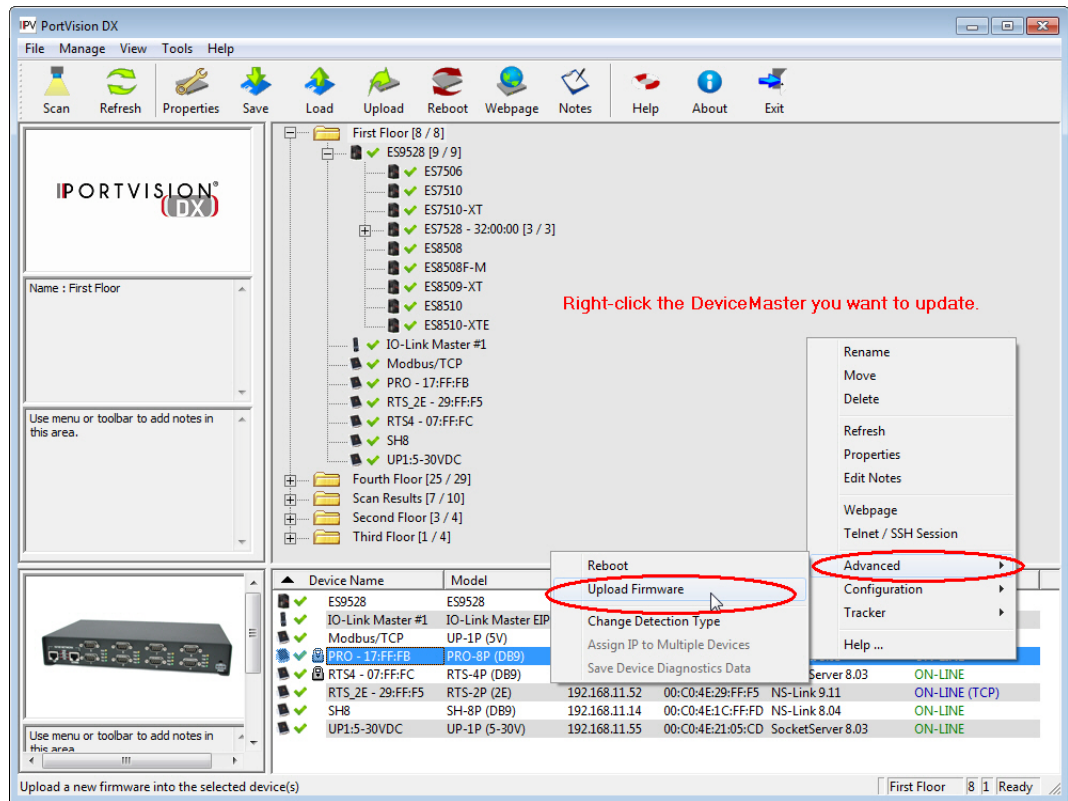

- Click **Yes** to the *Upload Firmware* message that warns you that this is a sensitive process.

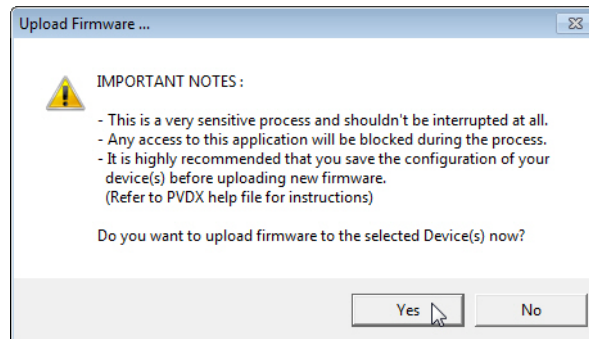

- Click **Ok** to the second *Upload Firmware* message.
- Right-click the DeviceMaster and click **Refresh** until the Bootloader version displays in the *Device List* pane and verify that the new version loaded.

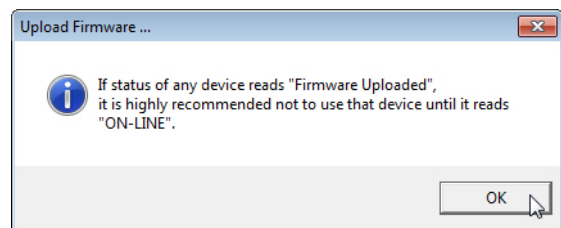

Checking the NS-Link Version

Use this procedure to check the NS-Link web page version. Remember, an NS-Link version displays when the NS-Link device driver has been installed and configured, NS-Link is the same firmware as SocketServer.

1. Start PortVision DX.
2. If necessary, click **Scan** to locate the DeviceMaster.

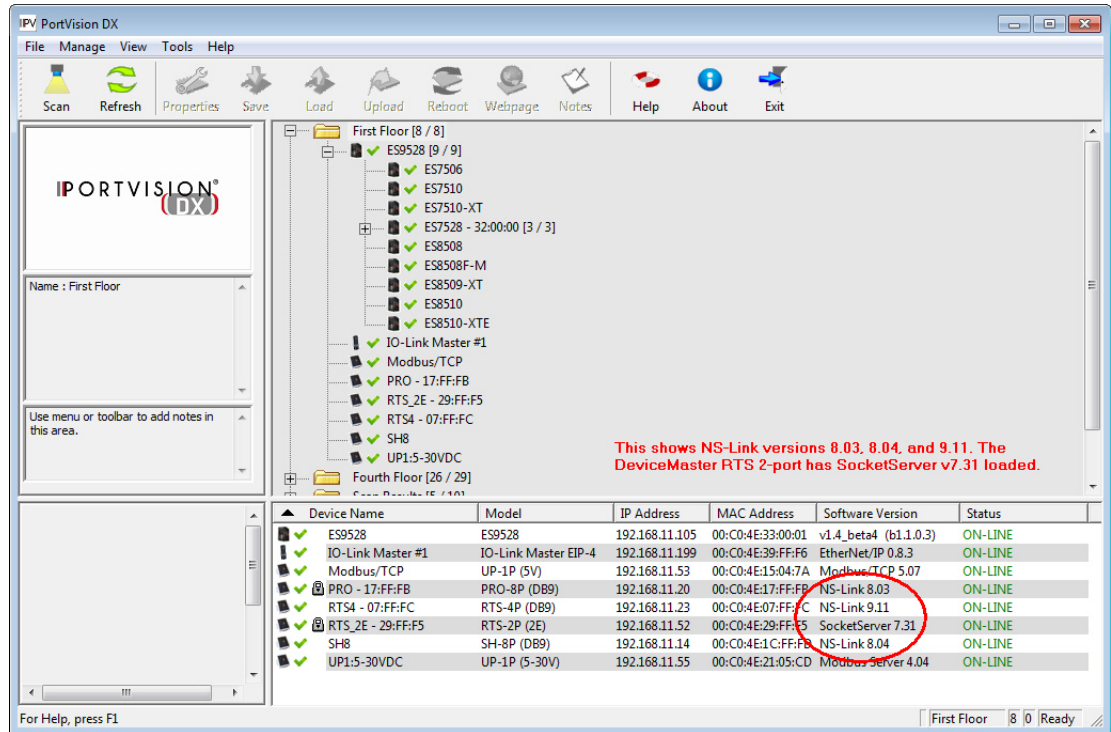

The *Device List* pane displays the NS-Link (SocketServer) version.

3. Check the Control ftp site to see if a later version is available.

To check the NS-Link version, you will need to check to see what version of SocketServer is available.

You can use this link to check to see what version of SocketServer/NS-Link is available at: ftp://ftp.control.com/dev_mstr/rts/software/SocketServer/.

4. Compare the version number displayed in PortVision DX to the version displayed in the ftp directory.

FTP directory /dev_mstr/rts/software/socketserver/ at ftp.comtrol.com

To view this FTP site in Windows Explorer, click **Page**, and then click **Open FTP Site in Windows Explorer**.

[Up to higher level directory](#)

```
03/11/2013 02:16PM      124,405 1800111\_socketserver\_history.pdf
02/08/2013 10:42AM      Directory help
10/02/2012 10:08AM      1,174,340 socketserver-8.04.bin
```

Note: In this example, the DeviceMaster contains v7.31 but v8.03 is available.

5. If a higher version of SocketServer is available and you want to update the DeviceMaster with the latest software:
 - a. Update SocketServer using [Uploading SocketServer with PortVision DX](#) on Page 45.
 - b. Download the latest driver from ftp://ftp.comtrol.com/dev_mstr/rts/drivers/win7.

FTP directory /dev_mstr/rts/drivers/win7/ at ftp.comtrol.com

To view this FTP site in Windows Explorer, click **Page**, and then click **Open FTP Site in Windows Explorer**.

[Up to higher level directory](#)

08/31/2012 11:38AM	6,775,432	devicemaster_windows_9.06.exe
08/01/2012 11:01AM		Directory sw_doc

- c. Update to the latest driver using the [DeviceMaster Device Driver \(NS-Link\) User Guide](#), which can be downloaded using Page 12 or viewed on the Control CD shipped with the DeviceMaster.

Restoring Factory Defaults (2-Port, Only)

Use the following procedures to restore a DeviceMaster 2-port model to the factory defaults. To return to default port settings, see [Restoring Serial Port Settings](#) on Page 132.

Note: For other models, see [Returning the DeviceMaster to Factory Defaults](#) on Page 179.

If Technical Support advises you to restore the DeviceMaster factory defaults, depress the **Reset/Restore** switch for greater than 5 seconds.

Restoring the DeviceMaster 2-port models resets the following to their factory defaults:

- Network settings
- Password
- Telnet enable
- Start up time-out
- SSL enable
- Telnet time-out

Restoring Serial Port Settings

Use the web page and/or the NS-Link device driver for Windows to restore the serial port settings to their default values.

The NS-Link serial port settings are independent of the socket serial port settings on the web page. If you are using COM ports and also have configured the port for socket services, you must restore the default port settings in the driver and web page.

NS-Link COM Port

You can use this procedure to reset NS-Link serial port settings.

1. Open the *Control Drivers Management Console* using **Start > Programs > Control > DeviceMaster** or under *Control Panel, Control Drivers Management Console*.
2. Highlight the first port that you want reset to default values.
3. Click the **Defaults** button (and if appropriate, **Clone**).
4. Click **Apply** or **Ok**.

If necessary, you can reset DeviceMaster device properties to their defaults on the *Device General* tab using the Defaults button.

Socket Port

Use the following procedure to reset the socket port serial settings.

1. Open the DeviceMaster web page ([Accessing Socket Configuration](#) on Page 69).
2. Scroll to the bottom of the *Server Status* page (main) and click **Reboot**.
3. When the **Reboot** page appears, click the **Set configuration for all ports to factory default settings** check box.



4. Click the **Yes, Reboot** button.

RedBoot Procedures

You can use this section as a reference if you want to perform tasks in RedBoot.

- [Accessing RedBoot Overview](#) on Page 133
- [Establishing a Serial Connection](#) on Page 134
- [Establishing a Telnet Connection](#) on Page 135
- [Determining the Network Settings](#) on Page 135
- [Configuring the Network Settings](#) on Page 136
- [Changing the Bootloader Timeout](#), Page 136
- [Determining the Bootloader Version](#) on Page 137
- [Resetting the DeviceMaster](#) on Page 137
- [Uploading Firmware - Telnet Method \(Linux\)](#) on Page 138
- [Configuring Passwords](#) on Page 140
- [RedBoot Command Overview](#) on Page 141.

Optionally, you can install PortVision DX on a Windows system on the network and perform all of these tasks except configuring a password. PortVision DX provides a Telnet/SSH session, which is discussed in

Accessing RedBoot Overview

To access RedBoot, you can use one of the following methods:

- A *serial* connection between Port 1 on the DeviceMaster and a COM port on a PC (Page 134). If you plan on using the serial method, you will need a null modem cable, a terminal program installed and configured on the PC, and a **Bootloader Timeout** value in excess of 15 seconds. If the **Bootloader Timeout** value has been reduced to 1 second, this procedure will NOT be possible.

Note: Use the serial connection method, if the DeviceMaster is not on the same Ethernet network segment as the PC.

If you do not know the IP address of the DeviceMaster you must use a serial connection to communicate with the DeviceMaster.

- A *telnet* connection (Page 135), if the DeviceMaster is locally accessible by Ethernet. A *telnet connection* requires that you know the IP address. In addition, the IP address must also be valid for the network to which it is attached.

For example: The network segment must be 192.168.250.x to telnet to the DeviceMaster default IP address if you have not changed the IP address to operate on your network.

Establishing a Serial Connection

Use the following procedure to set up a serial connection with a terminal server program. You can use HyperTerminal (Windows) or Minicom (Linux) or optionally, Test Terminal (WCom2), which can be accessed from PortVision DX using **Tools > Applications > Test Terminal (WCom2)**.

1. Connect a null-modem cable from an available COM port on your PC to **Port 1** on the DeviceMaster.

Note: See [Connecting Serial Devices](#) on Page 95, if you need to build a null-modem cable.

2. Configure the terminal server program to the following values:

- Bits per second = 57600
- Data bits = 8
- Parity = None
- Stop bits = 1
- Flow control = None

Note: If you do not disable Bootloader from loading (Steps 3 through 5) within the time-out period (default is fifteen seconds), an application will be loaded from flash and started. If this happens, repeat Steps 3 through 5. The **#!DM** command is the only case-sensitive command and must be in uppercase.

3. Reset the DeviceMaster.

Note: Depending on the model, disconnect and reconnect the power cable (external power supply and no power switch) or turn the power switch on and then off (internal power supply).

4. Immediately type **#!DM** and press **Enter** in the terminal program.

```
#!DM
RedBoot>dis
Loading disabled
```

5. At the **RedBoot>** prompt, type **dis**, and press **Enter**.
6. Verify that loading has been disabled.
7. You can use the appropriate procedure listed on Page 133 or use the [RedBoot Command Overview](#) on Page 141 to perform the desired task.

Establishing a Telnet Connection

Use the following procedure to telnet to the DeviceMaster.

1. Open a telnet session, enter the DeviceMaster IP address. If using Windows, open a **Command** window and type **telnet [ip_address]**
2. Press the **Enter** key if you did not program a password or type the password and press **Enter**.

```

♥♦
Password:

Control DeviceMaster RTS Model ID: 5002535

SocketServer 8.00
Built: Wed Nov 30 15:36:45 CST 2011
IP Addr: 192.168.11.30, Mask: 255.255.0.0, Gateway: 192.168.11.1
MAC Addr: 00:c0:4d:29:ff:f5

dm> reset

```

Note: The DeviceMaster does not come pre-programmed with a password.

3. Type **reset**, and close the session.
4. Open a new telnet session, enter the DeviceMaster IP address, and the password.
5. Type **dis** to disable the Bootloader.

```

*****
**
** Control DeviceMaster Bootloader Version 3.21
** RedBoot(tm) environment - built 20:20:56, May 18 2011
** Platform: Control DeviceMaster (ARM 7TDMI)
** Portions Copyright (C) 2000. Red Hat, Inc.
** Portions Copyright (C) 2001-2008 Control Corp.
*****

FLASH: 64 blocks of 65536 bytes each
FLASH: 4194304 bytes (0x05000000 - 0x05400000)
RAM: 8126464 bytes (0x00000000 - 0x007c0000)
RedBoot> dis
Loading disabled
RedBoot> _

```

6. Verify that the system responds with a **Loading disabled** message.

Determining the Network Settings

If you are not sure what the network information is on a DeviceMaster, you can perform the following procedure.

1. Establish communications with the DeviceMaster using the serial (Page 134) or telnet (Page 135) method.
2. At the **RedBoot** prompt, type **ip**.

Default Network Settings

IP address:
192.168.250.250

Subnet mask:
255.255.0.0

Gateway address:
192.168.250.1

```

RedBoot>dis
Loading disabled
RedBoot> ip
IP Config: IpAddr 192.168.250.250 IpMask 255.255.0.0 IpGate 192.168.250.1
RedBoot>

```

The IP address, subnet mask, and IP gateway values will display.

Note: *Optionally, you can install PortVision DX on a Windows system on the network and see the IP information in the Device List pane.*

Configuring the Network Settings

Use the following procedure to program the IP address using RedBoot.

1. Establish communications with the DeviceMaster using the serial (Page 134) or telnet (Page 135) method.
2. Enter **ip [addr mask gateway]** and press the **Enter** key to configure the IP address. *Where:*

addr = IP address you want to use

mask = matches you network subnet mask

gateway = assigned by your network administrator

Make sure that each value is separated by a space.

```
RedBoot>dis
Loading disabled
RedBoot> ip ###.###.###.### ###.###.###.### ###.###.###.###
RedBoot>
IP Config: IpAddr ###.###.###.### IpMask ###.###.###.### IpGate ###.###.###.###
RedBoot> reset
... Resetting
```

3. Verify that RedBoot responds with your configured network information or reissue the command.
4. Type **reset** to reset the DeviceMaster, if you do not have any other related RedBoot tasks.

Changing the Bootloader Timeout

Use the following procedure to change the Bootloader timeout value.

1. Establish communications with the DeviceMaster using the serial (Page 134) or telnet (Page 135) method.
2. At the **RedBoot** prompt, type **timeout**.

```
RedBoot> dis
Loading disabled
RedBoot> timeout
Timeout 15 seconds
RedBoot> timeout 45
timeout 45 seconds
RedBoot>_
```

RedBoot responds with the current Bootloader timeout value.

3. Type **timeout** and a value to change the timeout value. For example, **timeout 45** to change the Bootloader timeout to 45 seconds.

Determining the Bootloader Version

Use the following procedure to determine what Bootloader version is loaded in the DeviceMaster.

1. Establish communications with the DeviceMaster using the serial (Page 134) or telnet (Page 135) method.
2. At the **RedBoot** prompt, type **version**.

```
RedBoot> version
*****
**
** Control DeviceMaster Bootloader Version 3.21
** RedBoot(tm) environment - built 20:20:56, May 18 2011
** Platform: Control DeviceMaster (ARM 7TDMI)
** Portions Copyright (C) 2000. Red Hat, Inc.
** Portions Copyright (C) 2001-2008 Control Corp.
*****

FLASH: 64 blocks of 65536 bytes each
FLASH: 4194304 bytes (0x05000000 - 0x05400000)
RAM: 8126464 bytes (0x00000000 - 0x007c0000)
RedBoot>
```

The Bootloader information displays.

3. Type **reset** to reset the DeviceMaster, if you do not have any other related RedBoot tasks.

Note: *Optionally, you can install PortVision DX on a Windows system on the network and see the Bootloader version in the Device List pane. Reboot the DeviceMaster, right-click the DeviceMaster and click Refresh Device until the Bootloader version displays. The Bootloader version is only displayed for a few moments.*

Resetting the DeviceMaster

When you have completed your tasks in RedBoot, you must enter a **reset** command at the **RedBoot>** prompt for the DeviceMaster to begin operation.

Note: *The **LEDs** on the DeviceMaster will go through the power up sequence. The DeviceMaster has completed its reset cycle when the **PWR** or **Status LED** is lit and it stops flashing.*

```
RedBoot> dis
Loading disabled
RedBoot> reset
```

Uploading Firmware - Telnet Method (Linux)

Optionally, you can install PortVision DX on a Windows system on the network and upload firmware. PortVision DX is the recommended method for uploading firmware. See [Installing PortVision DX](#) on Page 37 and [Uploading SocketServer with PortVision DX](#) on Page 45.

Use the following procedure to update the Bootloader or SocketServer with telnet to the DeviceMaster.

A TFTP server is required to perform firmware updates using RedBoot.

- If you are using Windows, see [Updating Firmware Across WANs \(Windows\)](#) on Page 108 to install and use a TFTP server with PortVision DX.
- If you are using Linux and do not have a TFTP server installed, you can use [Setting Up a TFTP Server in Linux](#) (below). If you have a TFTP server installed, you can skip to [Uploading the Firmware](#) on Page 139.

Setting Up a TFTP Server in Linux

Use this procedure to set up a TFTP server.

1. Install and enable the tftp server software:

```
/usr/bin/up2date tftp-server
/sbin/chkconfig tftp on
```

2. Enter the following command so that it runs via `xinetd reload` to pick up the configuration file change:

```
/sbin/service xinetd reload
```

3. Edit the `/etc/sysconfig/iptables-config` file and change the `IPTABLES_MODULES` line to read:

```
IPTABLES_MODULES="ip_conntrack_tftp"
```

If you already have something in that line you can add the new module with a space in between, for example:

```
IPTABLES_MODULES="ip_conntrack_ftp ip_conntrack_tftp"
```

4. Add firewall rules to the `/etc/sysconfig/iptables` file. You only need UDP, though typically Control support recommends that you also add the TCP rules. The rules are both listed in `/etc/services` for port 69:

```
-A RH-Firewall-1-INPUT -s 192.168.250.250/16 -m tcp -p tcp --dport 69 -j ACCEPT
-A RH-Firewall-1-INPUT -s 192.168.250.250/16 -m udp -p udp --dport 69 -j ACCEPT
```

Note: The above IP address is the DeviceMaster default IP address.

5. Restart `iptables` to pick up the changes from Steps 3 and 4:

```
/sbin/service iptables restart
```

6. Add the proper lines to `/etc/hosts.allow`:

```
in.tftpd: 192.168.250.250
```

7. Go to [Uploading the Firmware](#) on Page 139 to load the firmware.

Uploading the Firmware

This Linux procedure requires that a TFTP server is installed.

1. Verify that you have the **.bin** file ([Locating Software and Documentation](#) on Page 12) and place the **.bin** file in **/tftpboot** so that you can retrieve it with the DeviceMaster.
2. Open a telnet session, enter the DeviceMaster IP address.
3. Press the **Enter** key, if you did not program a password or type the password and press **Enter**.

Note: *The DeviceMaster does not come pre-programmed with a password.*

4. Type **reset**, and close the session.
5. Open a new telnet session and enter the DeviceMaster IP address.

```
$ telnet 192.168.250.250 ←————— Default IP Address
Trying 192.168.250.250...
Connected to 192.168.250.250.
Escape character is '^]'.

```

6. Enter the webserver password and **Enter**, or press **Enter** if a password has not been set up.

```
Password:
*****
**
** Control DeviceMaster Bootloader Version 3.21
** RedBoot(tm) environment - built 20:20:56 May 18 2011
** Platform: Control DeviceMaster (ARM 7TDMI)
** Portions Copyright (C) 2000. Red Hat, Inc.
** Portions Copyright (C) 2001-2008 Control Corp.
*****

FLASH: 64 blocks of 65536 bytes each
FLASH: 4194304 bytes (0x05000000 - 0x05400000)
RAM: 8126464 bytes (0x00000000 - 0x007c0000)
RedBoot>

```

7. At the **RedBoot >** prompt: type **dis** and press **Enter** to disable the Bootloader.

```
RedBoot>dis
Loading disabled

```

8. Verify that the system responds with an **Loading disabled** message.
9. Load the file from a TFTP server using the following command and then press **Enter**:

load -r -b 0 -h <TFTP-Server_IP_Addr> <Downloaded_File_Name>

```
RedBoot> load -r -b 0 -h 192.168.250.1 1800110.bin
CCCCRaw load done: 139521 bytes read
Address range: 00000000-00022100, Entry point: 00000000.
xyzModem - Cksum mode, 1091(SOH)/0(STX)/0(CAN) packets, 6 retries
RedBoot>

```

10. When the **RedBoot>** prompt appears (after approximately one minute if you are uploading the Bootloader and approximately three minutes if you are uploading SocketServer), type **go**.

```
RedBoot>go

```

If uploading Bootloader: In a few seconds the ethernet and **PWR** or **Status LEDs** cycle through a light sequence once and the update is complete.

If uploading SocketServer:

- a. At the RedBoot> prompt, type: **fis list** and press **Enter**.

```
RedBoot> fis list
Name          FLASH addr  Mem addr    Length      Entry point
FIS_directory 0x053F0000  0x053F0000  0x00010000  0x00000000
default       0x05030000  0x00000000  0x00090000  0x00000000
RedBoot>
```

Note: You should see file information for a file called **default**. If you do not see this file, repeat the process starting with [Step 9](#).

- b. Reset the DeviceMaster by typing **reset** at the RedBoot> prompt.

Note: In a few seconds the ethernet and **PWR** or **Status LEDs** cycle through a light sequence once.

- c. Start your internet browser and enter the IP address of the DeviceMaster to verify that the new version of SocketServer loads.

Configuring Passwords

This section discusses how to configure a password for the web and telnet server.

Note: See the *PortVision DX* or *SocketServer Help* system for information about email notification.

Use the following procedure to establish the DeviceMaster password for the Web and telnet server. Establishing a password prevents unauthorized changes to the DeviceMaster configuration.

1. Establish communications with the DeviceMaster using the serial (Page 134) or telnet method (Page 135).
2. Type **password [your_password]** and press **Enter**.

Note: If you forget your password, you can reprogram the password using the serial method which bypasses the password.

```
Password:
*****
**
** Control DeviceMaster Bootloader Version 3.05
** RedBoot(tm) environment - built 20:20:56, May 18 2011
** Platform: Control DeviceMaster (ARM 7TDMI)
** Portions Copyright (C) 2000. Red Hat, Inc.
** Portions Copyright (C) 2001-2008 Control Corp.
*****

FLASH: 64 blocks of 65536 bytes each
FLASH: 4194304 bytes (0x05000000 - 0x05400000)
RAM: 8126464 bytes (0x00000000 - 0x007c0000)
RedBoot> dis
Loading disabled
RedBoot> password dev1357
Password 'dev1357'
RedBoot>
```

Note: The Bootloader version on your DeviceMaster may be different than the version displayed in this graphic.

See the **auth** command in the [RedBoot Command Overview](#) on Page 141, if you want to set up Web browser authentication.

RedBoot Command Overview

The following table is an overview of RedBoot commands available. After accessing RedBoot, you can review the list of commands online by entering **help** and pressing the **Enter** key.

For more detailed information, see the *eCos Reference Manual* that is located on the *Control Software and Documentation* CD or you can download it from: ftp://ftp.comtrol.com/dev_mstr/rts/software/redboot/user_guide.

RedBoot Commands	
auth {noaccess, none, basic, md5, invalid}	Sets or displays web authentication. The default is set to none , which means that there is no authentication required to access the web server. To deny access to the web server, click noaccess or invalid . If access is attempted, a message appears to notify the user that access is denied. To configure the web server to request an un-encrypted password, click basic . To configure the web server to request an encrypted password, click md5 . (Some browsers do not support the md5 command.)
boardrev †	Displays the board revision.
cache [ON OFF]	Manages machine caches.
channel [-1 <channel number>]	Displays or switches the console channel.
chassis	Displays chassis information.
cksum -b <location> -l <length>	Computes a 32-bit checksum [POSIX algorithm] for a range of memory.
disable	Disables automatic load of the default application.
dump -b <location> [-l <length>] [-s] [-1 2 4]	Displays (hex dump) of a range of memory.
fis {cmds}	Manages flash images. See Chapter 2 of the eCos Reference Manual for {cmds} information.
flash	Shows flash information.
go [-w <timeout>] [-c] [-n] [entry]	Executes code at a location.
help <topic>	Displays available RedBoot commands.
history	Displays command history.
ip [addr mask gateway]	Displays or sets the IP address configuration.
load [-r] [-v] [-h <host>] [-p <TCP port>] [-m <TFTP xyzmodem>] [-c <channel_number>] [-b <base_address>] <file_name>	Loads a file from TFTP server or XModem.
loop 232 422 int port-number	Runs loopback test on port. The DeviceMaster Serial Hub does not support this command.
mac †	Displays ethernet MAC address.
mcmp -s <location> -d <location> -l <length> [-1 -2 -4]	Compares two blocks of memory.

RedBoot Commands (Continued)	
<code>mcopy -s <location> -d <location> -l <length> [-1 -2 -4]</code>	Copies memory from one address to another.
<code>mfill -b <location> -l <length> -p <pattern> [-1 -2 -4]</code>	Fills a block of memory with a pattern.
<code>model†</code>	Shows model number.
<code>password {password}</code>	Sets or deletes the password.
<code>ping [-v] [-n <count> [-l <length>] [-t <timeout>] [-r <rate>] [-i <IP_addr>] -h <IP_addr></code>	Network connectivity test.
<code>reset</code>	Resets the DeviceMaster.
<code>secureconf [disable enable]</code>	Sets or displays secure config enable.
<code>securedata [disable enable]</code>	Sets or displays secure data enable.
<code>?</code>	Displays short help.
<code>snmp [disable enable]</code>	Sets or displays SNMP enable.
<code>telnet [disable enable]</code>	Sets or displays telnet server enable. Disables telnet.
<code>tetimeout [seconds]</code>	Shows or sets telnet time-out.
<code>terse</code>	Terse command response mode.
<code>t485 port #1 port #2</code>	Runs port-to-port RS-485 test. This is not available on the DeviceMaster Serial Hub.
<code>timeout {seconds}</code>	Displays or sets Bootloader time-out value.
<code>version</code>	Displays RedBoot version information.
<code>x -b <location> [-l <length>] [-s] [-1 2 4]</code>	Displays (hex dump) a range of memory.
<i>† Do not use these commands to change the values. Doing so would cause the DeviceMaster to stop functioning.</i>	

Hardware Specifications

Locating DeviceMaster Specifications

Specifications can be found on the Control web site at the following addresses.

Product	Ports	Connector/ Number of Ethernet Ports	Specification Web Page
DeviceMaster PRO	8	DB9/2E	http://www.comtrol.com/pub/products/product/pid/163
DeviceMaster PRO	16	DB9/2E	http://www.comtrol.com/pub/products/product/pid/164
DeviceMaster RTS (5V)	1	DB9/1E	http://www.comtrol.com/pub/products/product/pid/167
DeviceMaster RTS VDC (5-30VDC)	1	DB9/1E	http://www.comtrol.com/pub/products/product/pid/168
DeviceMaster RTS VDC embedded (5- 30VDC)	1	DB9/1E	http://www.comtrol.com/pub/products/product/pid/169
DeviceMaster RTS	2	Screw terminals/ 1E	http://www.comtrol.com/pub/products/product/pid/170
DeviceMaster RTS	2	Screw terminals/ 2E	http://www.comtrol.com/pub/products/product/pid/171
DeviceMaster RTS	2	DB9/1E	http://www.comtrol.com/pub/products/product/pid/165
DeviceMaster RTS	2	DB9/2E	http://www.comtrol.com/pub/products/product/pid/166
DeviceMaster RTS	4	DB9/2E	http://www.comtrol.com/pub/products/product/pid/172
DeviceMaster RTS	4	DB9/2E	http://www.comtrol.com/pub/products/product/pid/173
DeviceMaster RTS	8	DB9/2E	http://www.comtrol.com/pub/products/product/pid/174
DeviceMaster RTS	8	RJ45/2E	http://www.comtrol.com/pub/products/product/pid/175
DeviceMaster RTS	16	RJ45/1E	http://www.comtrol.com/pub/products/product/pid/177
DeviceMaster RTS	16	RJ45/2E	http://www.comtrol.com/pub/products/product/pid/176
DeviceMaster RTS	32	RJ45/1E	http://www.comtrol.com/pub/products/product/pid/178
DeviceMaster Serial Hub	8	DB9/2E	http://www.comtrol.com/pub/products/product/pid/179
DeviceMaster Serial Hub	16	DB9/2E	http://www.comtrol.com/pub/products/product/pid/180

External Power Supply Specifications

This subsection discusses information that you may need if you wish to use your own external power supplies.

- [1-Port 5VDC Power Supply](#) (below)
- [1-Port 5-30VDC Power Supply](#) on Page 144
- [2-Port \(Serial Terminals\) Power Supply](#) on Page 145
- [2-Port \(DB9\) Power Supply](#) on Page 145
- [4-Port Power Supply](#) on Page 146
- [8-Port Power Supply](#) on Page 146
- [16-Port Power Supplies](#) on Page 146

1-Port 5VDC Power Supply

This subsection only provides information for the DeviceMaster 1-port 5VDC model.

Control Power Supply: 1-Port 5VDC	
Input line frequency	47 - 63 Hz
Input line voltage	90 - 132VAC (<i>standard RTS</i>) 90 - 260VAC (<i>IAD model</i>)
Output voltage	5VDC
Output current	2.4A @ 5VDC

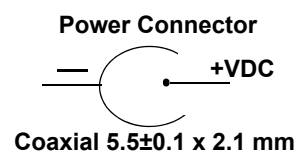

The following table provides the specifications, if you intend on purchasing your own external power supply.

External Power Supply: 1-Port 5VDC	
Output voltage†	5VDC
Current†	420 mA (Min) @ 5VDC
Power	2.1 W
† Any power supply that meets current consumption, voltage, power, and connector pinouts requirements can be used.	

1-Port 5-30VDC Power Supply

This table provides specifications for the optional power supply from Comtrol.

Control Power Supply: 1-Port 5-30VDC	
Input line frequency	43-63 Hz
Input line voltage	90-260 VAC
Output voltage	24VDC
Output current	500 mA @ 24VDC

This table provides the specifications, if you intend on using your own power supply.

External Power Supply: 1-Port 5-30VDC	
Output voltage†	5-30VDC
Current†	100 mA (Min) @ 24VDC
Power	2.5 W
† Any power supply that meets current consumption, voltage, power, and connector pinouts requirements can be used.	

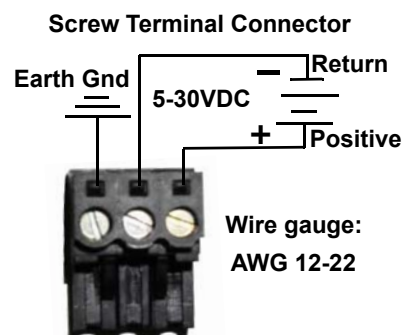

2-Port (Serial Terminals) Power Supply

This table provides the specifications to purchase a power supply for a DeviceMaster 2-port 1E/2E model with serial terminal connectors.

External Power Supply: 2-Port (Serial Terminal Connectors) 5-30VDC	
Output voltage†	5-30VDC
Current†	100 mA (Min) @ 24VDC
Power	2.5 W
† Any power supply that meets current consumption, voltage, power, and connector pinouts requirements can be used.	

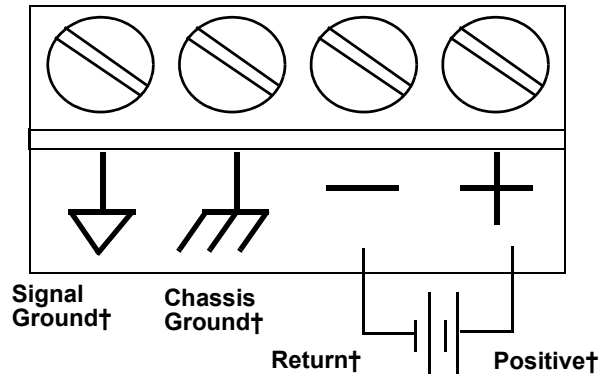

2-Port (DB9) Power Supply

This table provides the specifications to purchase a power supply for a DeviceMaster 2-port 1E/2E model with serial terminal connectors.

External Power Supply: 2-Port (Serial Terminal Connectors) 6-30VDC	
Output voltage†	6-30VDC
Current†	100 mA (Min) @ 24VDC
Power	2.5 W
† Any power supply that meets current consumption, voltage, power, and connector pinouts requirements can be used.	

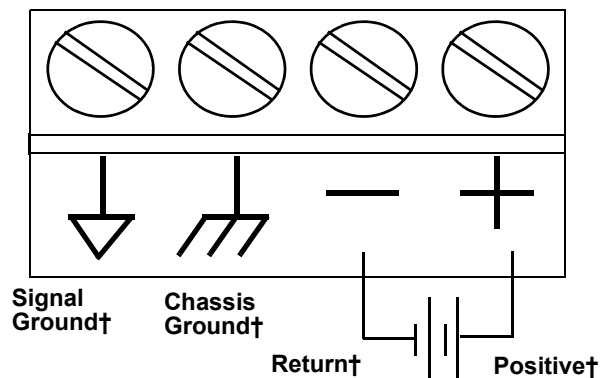

4-Port Power Supply

This table provides the specifications for the power supply shipped with the DeviceMaster 4-port.

Control Power Supply: 4-Port	
Input line frequency	47 - 63 Hz
Input line voltage	90 - 260 VAC
Output voltage	24VDC
Output current	500 mA @ 24VDC

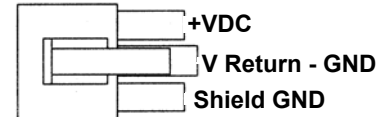

Housing Molex P/N:
39-01-4030
Pins Molex P/N:
44485-1211

This table provides the specifications, if you intend on using your own power supply.

External Power Supply: 4-Port	
Output voltage†	9-30VDC
Current†	200 mA (Min) @ 24VDC
Power	4.8 W
† Any power supply that meets current consumption, voltage, power, and connector pinouts requirements can be used.	

8-Port Power Supply

The following table provides the specifications for the Control-supplied power supply for the DeviceMaster 8-port.

Control Power Supply: 8-Port	
Input line frequency	47 - 63 Hz
Input line voltage	90 - 260 VAC
Output voltage	24VDC
Output current	500 mA @ 24VDC

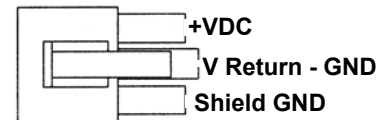

Housing Molex P/N:
39-01-4030
Pins Molex P/N:
44485-1211

The following table provides the specifications, if you intend on purchasing your own power supply.

External Power Supply: 8-Port	
Output voltage†	9-30VDC
Current†	290 mA (Min) @ 24VDC
Power	6.96 W
† Any power supply that meets current consumption, voltage, power, and connector pinouts requirements can be used.	

16-Port Power Supplies

The following table provides the specifications for the Control-supplied power supply for the DeviceMaster 16-port models.

Control Power Supply: 16-Port Models	
Input line frequency	47 - 63 Hz
Input line voltage	90 - 260 VAC
Output voltage	24VDC
Output current	500 mA @ 24VDC
Note: The DeviceMaster RTS 16-port and 32-port models with a single Ethernet port have internal power supplies.	

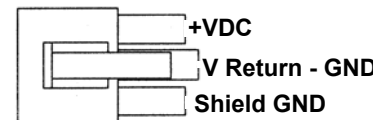

Housing Molex P/N:
39-01-4030
Pins Molex P/N:
44485-1211

The following tables provide the specifications, if you intend on purchasing your own power supply for your DeviceMaster.

External Power Supply: 16-Port DeviceMaster PRO	
Input line frequency	47 - 63 Hz
Input line voltage	90 - 260VAC
Output voltage†	9-30VDC
Output current†	290 mA (Min) @ 24VDC
† Any power supply that meets current consumption, voltage, power, and connector pinouts requirements can be used.	

External Power Supply: 16-Port DeviceMaster RTS	
Output voltage†	9-30VDC
Current†	490 mA (Min) @ 24VDC
Power	11.76 W
† Any power supply that meets current consumption, voltage, power, and connector pinouts requirements can be used.	

External Power Supply: 16-Port DeviceMaster Serial Hub	
Input line frequency	47 - 63 Hz
Input line voltage	90 - 260VAC
Output voltage†	9-30VDC
Output current†	132 mA (Min) @ 24VDC
† Any power supply that meets current consumption, voltage, power, and connector pinouts requirements can be used.	

DeviceMaster Product Pictures

This subsections provides you with detailed pictures of the different DeviceMaster models:

- [1-Port \(DB9\) 5VDC](#) on Page 148
- [1-Port \(DB9\) 5-30VDC](#) on Page 148
- [1-Port Embedded](#) on Page 149
- [2-Port \(Single Ethernet Port\) with Serial Terminals](#) on Page 149
- [2-Port \(Dual Ethernet Ports\) with Serial Terminals](#) on Page 150
- [2-Port \(Single Ethernet Port\) DB9](#) on Page 150
- [2-Port \(Dual Ethernet Ports\) DB9](#) on Page 151
- [4-Port \(DB9\)](#) on Page 151
- [8-Port \(DB9\)](#) on Page 151
- [16-Port \(RJ45\) External Power Supply](#) on Page 151
- [DeviceMaster Serial Hub 16-Port \(DB9\)](#) on Page 152
- [16-Port \(RJ45\) Internal Power Supply](#) on Page 152
- [DeviceMaster PRO 16-Port \(RJ45\)](#) on Page 152
- [DeviceMaster RTS 32-Port \(RJ45\)](#) on Page 152

1-Port (DB9) 5VDC

This illustrates the DeviceMaster 1-Port 5VDC.



See [DeviceMaster LEDs](#) on Page 174 for information about the LEDs.

1-Port (DB9) 5-30VDC

This illustrates the DeviceMaster 1-Port 5-30VDC.



Note: The supported input voltage (5VDC or 5-30VDC) is printed on the top and bottom of the DeviceMaster.

See [DeviceMaster LEDs](#) on Page 174 for information about the LEDs.

1-Port Embedded

This illustrates the DeviceMaster 1-port Embedded system that uses a 5-30VDC power supply. See [1-Port 5-30VDC Power Supply](#) on Page 144 so that you can provide a power supply for the DeviceMaster. See [DeviceMaster LEDs](#) on Page 174 for information about the LEDs.

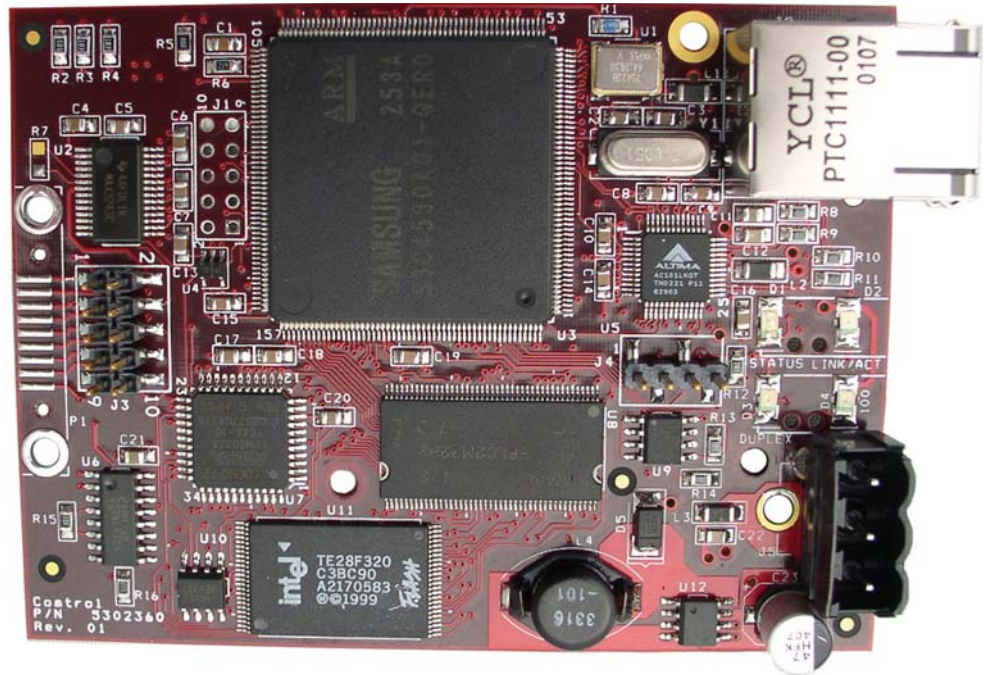

2-Port (Single Ethernet Port) with Serial Terminals

The DeviceMaster 2-port 1E with serial terminals uses a 5-30VDC power supply. See [2-Port \(Serial Terminals\) Power Supply](#) on Page 145 for information about the power supply. See [DeviceMaster LEDs](#) on Page 174 for information about the LEDs.



2-Port (Dual Ethernet Ports) with Serial Terminals

The DeviceMaster 2-port 2E with serial terminals uses a 5-30VDC power supply. See [2-Port \(Serial Terminals\) Power Supply](#) on Page 145 for information about the power supply. See [DeviceMaster LEDs](#) on Page 174 for information about the LEDs.



2-Port (Single Ethernet Port) DB9

The DeviceMaster 2-port 1E DB9 uses a 5-30VDC power supply. See [2-Port \(DB9\) Power Supply](#) on Page 145 for information about the power supply. See [DeviceMaster LEDs](#) on Page 174 for information about the LEDs.



2-Port (Dual Ethernet Ports) DB9

The DeviceMaster 2-port 2E DB9 uses a 5-30VDC power supply. See [2-Port \(DB9\) Power Supply](#) on Page 145 for information about the power supply. See [DeviceMaster LEDs](#) on Page 174 for information about the LEDs.

**4-Port (DB9)**

The PWR LED for the DeviceMaster 4 with DB9 ports is on the other side of the unit. See [DeviceMaster LEDs](#) on Page 174 for information about the LEDs.

**8-Port (DB9)**

The PWR LED for the DeviceMaster 8 with DB9 ports is on the other side of the unit. See [DeviceMaster LEDs](#) on Page 174 for information about the LEDs.

**16-Port (RJ45)
External Power Supply**

The PWR LED for this model is on the other side of the unit. See [DeviceMaster LEDs](#) on Page 174 for information about the LEDs.

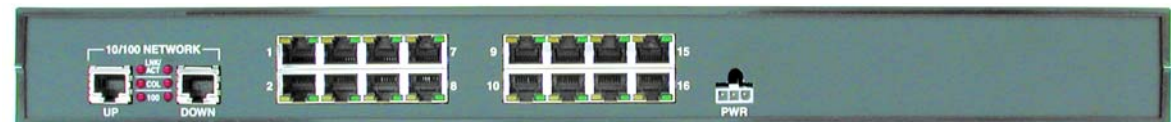

**16-Port (RJ45)
Internal Power
Supply**

The power switch for this model is on the other side of the unit. See [DeviceMaster LEDs](#) on Page 174 for information about the LEDs.



**DeviceMaster PRO
16-Port (RJ45)**

The power connector for this model is on the other side of the unit. See [DeviceMaster LEDs](#) on Page 174 for information about the LEDs.



**DeviceMaster Serial
Hub 16-Port (DB9)**

The power switch for this model is on the other side of the unit.



**DeviceMaster RTS
32-Port (RJ45)**

The power switch for this model is on the other side of the unit. See [DeviceMaster LEDs](#) on Page 174 for information about the LEDs.



Notices

Radio Frequency Interference (RFI) (FCC 15.105)

This equipment has been tested and found to comply with the limits for Class A digital devices pursuant to Part 15 of the FCC Rules.

This equipment generates, uses, and can radiate radio frequency energy, and if not installed and used in accordance with the instruction manual, may cause harmful interference to radio communications. However, there is no guarantee that interference will not occur in a particular installation. If this equipment does cause harmful interference to radio or television reception, which can be determined by turning the equipment off and on, the user is encouraged to try and correct the interference by one or more of the following measures:

- Reorient or relocate the receiving antenna.
- Increase the separation between the equipment and the receiver.
- Connect the equipment into an outlet on a circuit different from that to which the receiver is connected.
- Consult the dealer or an experienced radio/TV technician for help.

Labeling Requirements (FCC 15.19)

This equipment complies with part 15 of FCC rules. Operation is subject to the following two conditions:

- This device may not cause harmful interference.
- This device must accept any interference received, including interference that may cause undesired operation.

Modifications (FCC 15.21)

Changes or modifications to this equipment not expressly approved by Comtrol Corporation may void the user's authority to operate this equipment.

Serial Cables (FCC 15.27)

This equipment is certified for Class A operation when used with unshielded cables on models with the RJ45 connectors and with shielded cables on all models with DB9 connectors.

Underwriters Laboratory

This equipment is Underwriters Laboratory "UL" listed.

Important Safety Information



To avoid contact with electrical current:

- Never install electrical wiring during an electrical storm.
- Never install the power plug in wet locations.
- Use a screwdriver and other tools with insulated handles.

Troubleshooting and Technical Support

This section contains troubleshooting information for your DeviceMaster. You may want to review the following subsections before calling Technical Support because they will request that you perform many of the procedures or verifications before they will be able to help you diagnose a problem.

- [Troubleshooting Checklist](#) on Page 155
- [General Troubleshooting](#) on Page 157
- [Testing Ports Using Port Monitor \(PMon2\)](#) on Page 159
- [Testing Ports Using Test Terminal](#) on Page 162
- [Socket Mode Serial Port Testing](#) on Page 168
- [Daisy-Chaining DeviceMaster 2E/4/8/16-Port Units](#) on Page 173
- [DeviceMaster LEDs](#) on Page 174
- [Removing DeviceMaster Security Features](#) on Page 177
- [Returning the DeviceMaster to Factory Defaults](#) on Page 179

If you cannot diagnose the problem, you can contact [Technical Support](#) on Page 182.

Troubleshooting Checklist

The following checklist may help you diagnose your problem:

- Verify that you are using the correct types of cables on the correct connectors and that all cables are connected securely.

Note: *Most customer problems reported to Control Technical Support are eventually traced to cabling or network problems.*

Model	Connected to	Ethernet Cable	Connector Name
1-Port	Ethernet hub or NIC	Standard	10/100 ETHERNET
1-Port Embedded	Ethernet hub or NIC	Standard	RJ45 port (not labeled)
2-Port - 1E (All models)	Ethernet hub or NIC	Standard	10/100
2-Port - 2E (All dual Ethernet ports)	NIC or Ethernet hub	Standard	10/100 - E1/E2
4/8-Port	NIC	Standard	DOWN
	Ethernet hub	Standard	UP
16-Port (external power supply)	NIC	Standard	DOWN
	Ethernet hub	Standard	UP
16/32-Port (internal power supply)	Ethernet hub or NIC	Standard	10/100 NETWORK

- Verify that the network IP address, subnet mask, and gateway is correct and appropriate for the network. Make sure that the IP address programmed into the DeviceMaster matches the unique reserved IP configured address assigned by the system administrator.
 - If IP addressing is being used, the system should be able to ping the DeviceMaster.
 - If using DHCP, the host system needs to provide the subnet mask and gateway.
- Verify that the Ethernet hub and any other network devices between the system and the DeviceMaster are powered up and operating.
- Verify that the hardware MAC address in the NS-Link device driver matches the address on the DeviceMaster.
- If using a driver for Windows, verify that you are addressing the port correctly. In many applications, device names above COM9 require the prefix \\.\ in order to be recognized. For example, to reference COM20, use \\.\COM20 as the file or port name.
- If using a driver for Windows, you can use one of the Control tools.
 - *Advanced* tab in the *Control Drivers Management Console* which helps identify problems.
 - PortVision DX contains two applications that can be used to test or monitor the DeviceMaster:
 - *Test Terminal* program, which can be used to troubleshoot communications on a port-by-port basis. See [Testing Ports Using Test Terminal](#) on Page 162 for testing procedures.
 - *Port Monitor* program, which checks for errors, modem control, and status signals. In addition, it provides you with raw byte input and output counts. See [Testing Ports Using Port Monitor \(PMon2\)](#) on Page 159 for procedures.
 - Enable the **Verbose Event Log** feature on the **Device General** tab and then reboot the system.
- Reboot the system, then reset the power on the DeviceMaster and watch the **PWR** or **Status** (Page 174) light activity.

PWR or Status LED	Description
5 sec. off, 3 flashes, 5 sec. off, 3 flashes...	RedBoot™ checksum failure.
5 sec. off, 4 flashes, 5 sec. off, 4 flashes...	SREC load failure.
5 quick flashes	The default application is starting up.
10 sec. on. 1 sec. off, 10 sec. on.1 sec. off...	The default application is running.

Note: *If the device has a power switch, turn the device's power switch off and on, while watching the LED diagnostics. If the DeviceMaster does not have a power switch, disconnect and reconnect the power cord.*

- Remove and reinstall the DeviceMaster NS-Link device driver.
- If you have a spare DeviceMaster, try replacing the device.

General Troubleshooting

This table illustrates some general troubleshooting tips.

Note: Make sure that you have reviewed the [Troubleshooting Checklist](#) on Page 155.

General Condition	Explanation/Action
PWR or Status LED flashing	<p>Indicates that boot program has not downloaded to the DeviceMaster.</p> <ol style="list-style-type: none"> 1. If applicable, remove the NS-Link driver. 2. Make sure that you have downloaded the most current driver: ftp://ftp.comtrol.com/dev_mstr/rts/drivers/. 3. Install the latest driver and configure the DeviceMaster using the MAC address. Make sure that you reboot the system. See Device Driver (NS-Link) Installation on Page 53 for procedures. <p>Note: If the PWR or Status LED is still flashing, contact Technical Support.</p>
PWR or Status LED not lit	<p>Indicates that power has not been applied or there is a hardware failure. Contact Technical Support.</p>
Can ping the Control device, but cannot open the ports from a remote location. (You must have previously programmed the IP address, subnet mask, and IP gateway.)	<p>The NS-Link driver uses Port 4606 (11FE h) to communicate with the DeviceMaster.</p> <p>When using a <i>sniffer</i> to track NS-Link packets, filtering for Port 4606 will easily track the packet. The packet should also contain the MAC address of the device and the originating PC so that it can be determined if the packet is able to travel the full distance one way or not.</p> <p>If the 4606 packet is found on one side of a firewall or router, using sniffer, and not on the other side, then that port needs to be opened up to allow the 4606 to pass.</p> <p>This will most often be seen with firewalls, but is also seen in some routers.</p>
Cannot ping the device through Ethernet hub	<p>Isolate the DeviceMaster from the network. Connect the device directly to the NIC in the host system (see Page 155).</p>
Cannot ping or connect to the DeviceMaster	<p>The default DeviceMaster IP address is often not accessible due to the subnet masking from another network unless 192.168 is used in the network.</p> <p>In most cases, it will be necessary to program in an address that conforms to your network. See Configuring the Network Settings on Page 40 to use PortVision DX to program the IP address.</p> <p>If you do not use PortVision DX (or the NS-Link driver for Windows) to program the IP address, you can use RedBoot.</p> <p>If you use RedBoot, you only have 15 seconds to disable the Bootloader with RedBoot to get into the setup utility. See RedBoot Procedures on Page 133 for the RedBoot method of programming an IP address.</p>

General Condition	Explanation/Action
<p>DeviceMaster continuously reboots when connected to some Ethernet switches with the NS-Link driver</p>	<p>The problem is caused by a L2 bridging feature called Spanning Tree Algorithm (STA) in the switch. This feature is enabled by default in some switches. This feature causes time-out problems on certain L2 protocols, such as our MAC mode.</p> <p><i>Resolution:</i> There will be no firmware fix for this problem. Only one of the following fixes is required for resolution.</p> <ol style="list-style-type: none"> 1. Disable STA in the switch. 2. Enable STA fast forwarding on the port. 3. Change the STA Forward Delay and Message Age to minimum time values. 4. On the device, set the time-out value to 0 (to disable loading of SocketServer) or 120. The command from the redboot prompt is "Timeout 120" without the quotes. <p><i>Problem Details:</i> STA by default blocks packets for 30 seconds after an ethernet port auto negotiates. Blocking of these packets causes the NS-Link driver load process to fail.</p> <p>The normal NS-Link driver load process is:</p> <ol style="list-style-type: none"> 1. If NS-Link determines that it needs to load a device, it resets the device. It does this to get the device into RedBoot mode. Only RedBoot accepts load binary commands, which are needed to load the NS-Link binary into the DeviceMaster. 2. After a 6 second delay, NS-Link sends an ID query to the device. This query is to verify that the device is in RedBoot and can accept load binary commands. 3. The device sends an ID query response. 4. NS-Link loads the device. <p>If the device is not loaded after timeout seconds (default 15), it loads SocketServer.</p> <p>The above process fails when STA is running because the switch blocks packets for 30 seconds after the DeviceMaster reboots. Therefore, the ID query is not received by the DeviceMaster and after 15 seconds the device loads SocketServer. After 30 seconds, NS-Link finally can do an ID query, which reveals that the device is not in RedBoot. NS-Link therefore reboots the device, and the process repeats.</p>
<p>DeviceMaster continuously reboots when connected to some Ethernet switches or routers</p>	<p>Invalid IP information may also cause the switch or router to check for a gateway address. Lack of a gateway address is a common cause.</p>

Testing Ports Using Port Monitor (PMon2)

You can use this subsection to test the DeviceMaster driver installation. If you need to install the device driver, go to <ftp://ftp.comtrol.com/html/default.htm> to locate the latest driver and driver installation documentation.

Overview

This procedure will check whether the DeviceMaster can:

- Communicate through the Control device driver
- Determine if a port is open with an application

Testing Control COM Ports

If necessary, [Installing PortVision DX](#) on Page 37 to install PortVision DX, which contains Port Monitor.

1. Start PortVision DX from the **Start** menu, select **Programs > Control > PortVision DX > PortVision DX** or click the desktop shortcut.
2. Select **Tools > Applications > Port Monitor (PMon2)**.

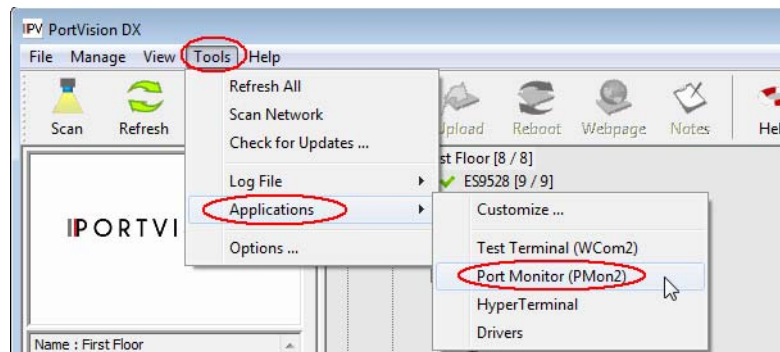

3. Click **Add Ports** using the icon or **Tools > Add Ports**,

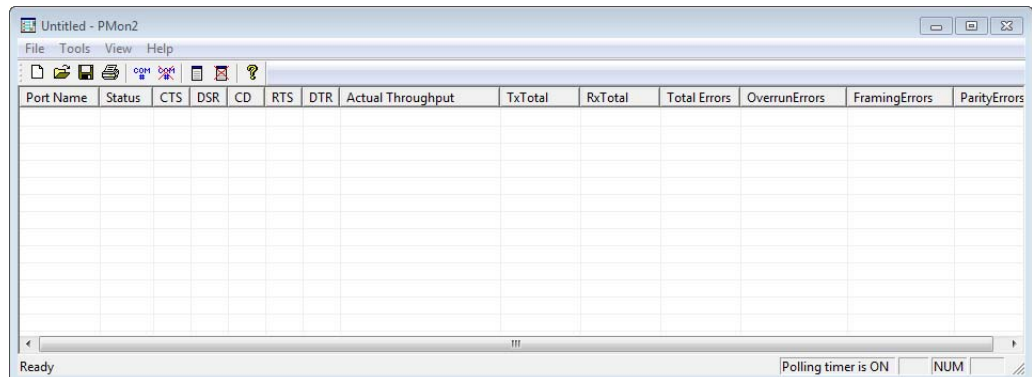

- Click **Driver**, click **RPSHSI/NSLINK**.

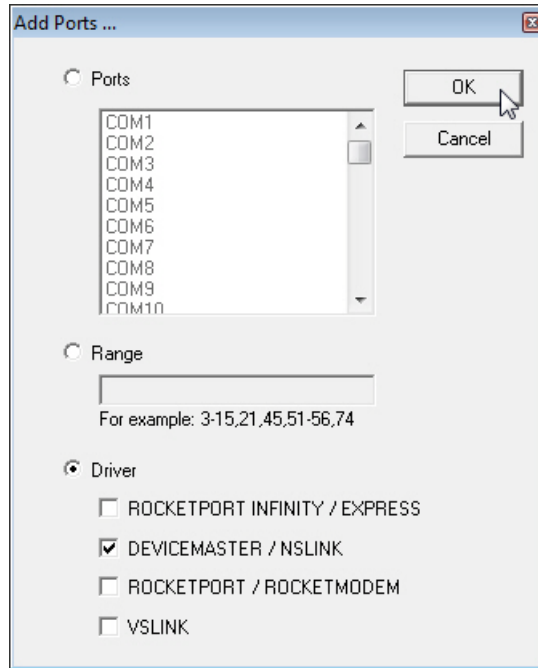

- If the DeviceMaster is communicating with the device driver for Windows, Port Monitor should display **CLOSED** status. If a port is open for an application, it displays as **OPEN**, and displays **Actual Throughput**, **TxTotal** and **RxTotal** statistics.

Port Name	Status	CTS	DSR	CD	RTS	DTR	Actual Throughput	TxTotal	RxTotal	Total Errors	FramingErrors	ParityErrors	OverrunErrorsRaw
COM4	CLOSED	OFF	OFF	OFF	OFF	OFF	0	0	0	0	0	0	0
COM5	OPEN	ON	ON	ON	ON	ON	115800	9105348	9101707	0	0	0	0
COM6	CLOSED	OFF	OFF	OFF	OFF	OFF	0	0	0	0	0	0	0
COM9	CLOSED	OFF	OFF	OFF	OFF	OFF	0	0	0	0	0	0	0
COM10	CLOSED	OFF	OFF	OFF	OFF	OFF	0	0	0	0	0	0	0
COM11	CLOSED	OFF	OFF	OFF	OFF	OFF	0	0	0	0	0	0	0
COM12	CLOSED	OFF	OFF	OFF	OFF	OFF	0	0	0	0	0	0	0
COM18	CLOSED	OFF	OFF	OFF	OFF	OFF	0	0	0	0	0	0	0
COM25	CLOSED	OFF	OFF	OFF	OFF	OFF	0	0	0	0	0	0	0
COM26	CLOSED	OFF	OFF	OFF	OFF	OFF	0	0	0	0	0	0	0
COM100	CLOSED	OFF	OFF	OFF	OFF	OFF	0	0	0	0	0	0	0
COM101	CLOSED	OFF	OFF	OFF	OFF	OFF	0	0	0	0	0	0	0

Normally, there should be no data errors recorded or they should be very small. To find out what the actual errors are, scroll to the right. You will see three columns: **Overrun Errors**, **Framing Errors**, and **Parity Errors**.

If the errors are:

- Overrun Errors** represent receive buffer overflow errors. If this is the case, you will have to configure either software or hardware handshaking to control the flow of data. The most common errors are **Overrun** errors.
- Framing Errors** indicate that there is an synchronization error between the beginning of a data frame and the end of the data frame. A frame usually consists of a start bit, 8 data bits, and a stop bit or two. The framing error occurs if the stop bit is not detected or it occurs in the wrong time frame. Most causes for framing errors are electrical noise on the data lines, or differences in the data clocks of the DeviceMaster and the connected device.
- Parity Errors** occur when parity is used and the parity bit is not what is expected. This can also be caused by noise on the data lines.

6. You can view additional statistics to Port Monitor by adding columns. Click **Tools** and **Add Columns**.

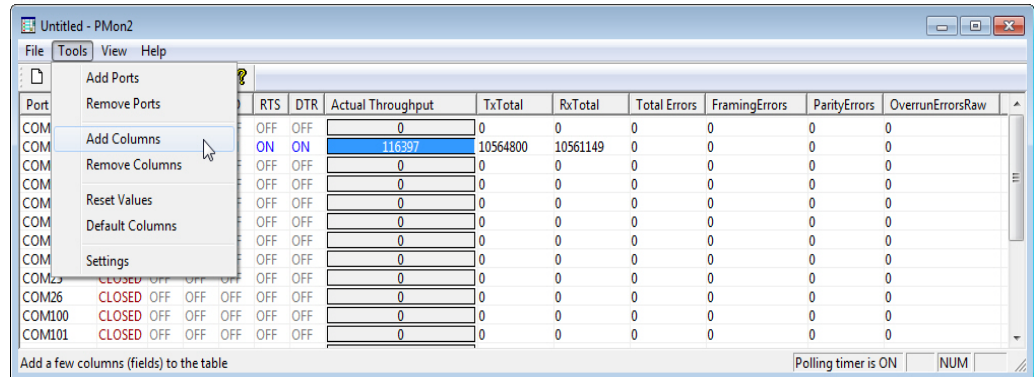

7. Highlight or shift-click to add multiple statistics and click **Ok**.

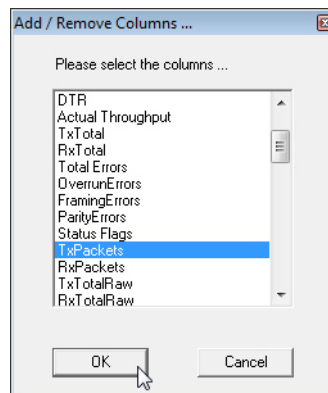

Note: See the Port Monitor help system if you need an explanation of a column.

8. Scroll to the right to view the new columns.

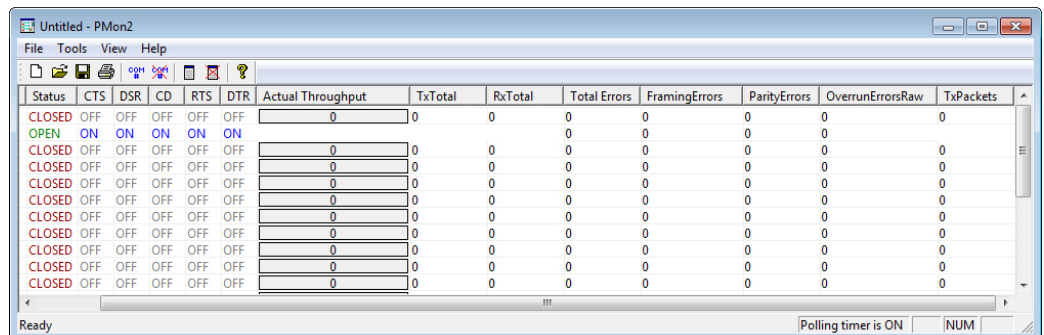

9. If you want to capture this session, you can save a current session as a report. To do this, select one of the following save options:

- **File > Save As**
- **File > Save** - if the report already exists in an older format
- **Save Active Session**  button

Reports can be opened, viewed and re-used when needed. To open and view a report:

- a. **Select File > Open** or the **Open Existing Session**  button. The *Open Session* dialog appears.
- b. Locate the session (table), you want to open and click the **Open** button.

Optionally, if you want to continue monitoring for an existing session, you need to activate the *Polling Interval*.

- **Select Tools > Settings** to access the PMon2 *Settings* dialog
 - Change the **Polling Interval** field to a value other than zero (0)
10. Leave Port Monitor open so that you can review events when using *Test Terminal* to test a port or ports.

Testing Ports Using Test Terminal

You can use the following procedure to test COM ports. If you need to install the DeviceMaster device driver, go to <ftp://ftp.comtrol.com/html/default.htm> to locate the latest driver and driver installation documentation.

The following procedures require a loopback plug to be placed on the port or ports that you want to test. A loopback plug was shipped with your product. If you need to build a replacement or additional loopback plugs, refer to [Connecting Serial Devices](#) on Page 95.

Overview

Test Terminal (WCom2) allows you to open a port, send characters and commands to the port, and toggle the control signals. This application can be used to troubleshoot communications on a port-by-port basis.

- **Send and Receive Test Data:** This sends data out the transmit line to the loopback plug, which has the transmit and receive pins connected thus sending the data back through the Rx line to Test Terminal, which then displays the received data in the terminal window for that port. This test is only testing the Tx and Rx signal lines and nothing else. This test works in either RS-232 or RS-422 modes as both modes have transmit and receive capability. A failure in this test will essentially prevent the port from working in any manner.
- **Loopback Test:** This tests all of the modem control signals such as RTS, DTR, CTS, DSR, CD, and RI along with the Tx and Rx signals. When a signal is made HI in one line the corresponding signal line indicates this. The Loopback Test changes the state of the lines and looks for the corresponding state change. If it successfully recognizes all of these changes, the port passes.

A failure on this test is not necessarily critical as it will depend on what is connected and how many signal lines are in use. For example, if you are using RS-232 in 3-wire mode (Transmit, Receive and Ground) a failure will cause no discernible issue since the other signals are not being used. If the port is configured for use as either RS-422 or RS-485 this test will fail and is expected to fail since RS-422 and RS-485 do not have the modem control signals that are present in RS-232 for which this test is designed.

Opening Ports

The following procedure shows how to use **Test Terminal** to send and receive test data to the serial ports. If necessary, use [Installing PortVision DX](#) on Page 37, which contains Test Terminal.

1. Stop all applications that may be accessing the ports such as RRAS or any faxing, or production software. See the appropriate help systems or manuals for instructions on stopping these services or applications.

If another application is controlling the port, then **Test Terminal** will be unable to open the port and an error message will be shown.

2. Start Test Terminal (WCom2). If necessary, start PortVision DX from the **Start** menu, select **Programs > Control > PortVision DX > PortVision DX** or click the desktop shortcut.
3. Select **Tools > Applications > Test Terminal (WCom2)**.

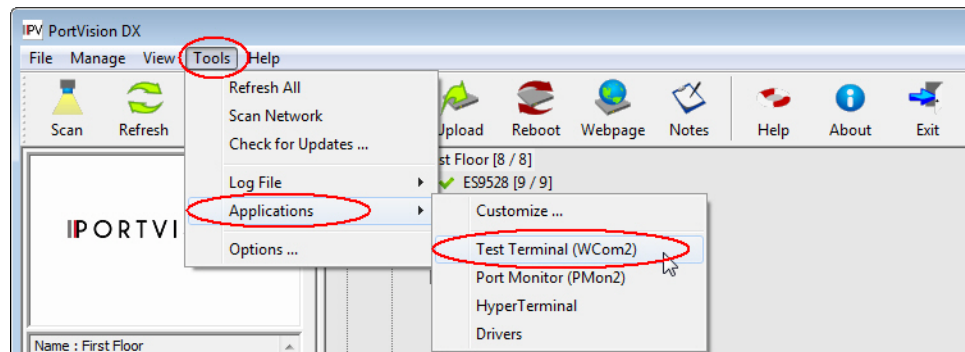

4. Select **File > Open Port**, the appropriate port (or ports) from the *Open Ports* drop list and **Ok**.

Note: If you left Port Monitor open from the previous subsection, you should show that the port is open.

Go to the appropriate procedure to send and receive test data.

- [Sending and Receiving Test Data \(RS-232/422/485: 4-Wire\)](#) (below)
- [Sending and Receiving Data \(RS-485: 2-Wire\)](#) on Page 165

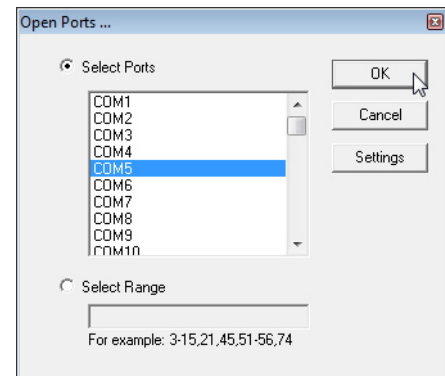

Sending and Receiving Test Data (RS-232/422/485: 4-Wire)

You can use this procedure to send and receive test data through the RS-232/422/485 (4-wire, full-duplex) port or ports that you want to test.

1. If you have not done so, perform [Steps 1](#) through [2](#) on Page 163.
2. Install the loopback plug onto the port (or ports) that you want to test. See [Connecting Serial Devices](#) on Page 95, if you need to build loopback plugs.
3. Select **Port > Send and Receive Test Data**.

You should see the alphabet scrolling across the port. If so, then the port installed properly and is operational.

Note: *If you left Port Monitor running, it should show data sent and received and show the average data throughput on the port.*

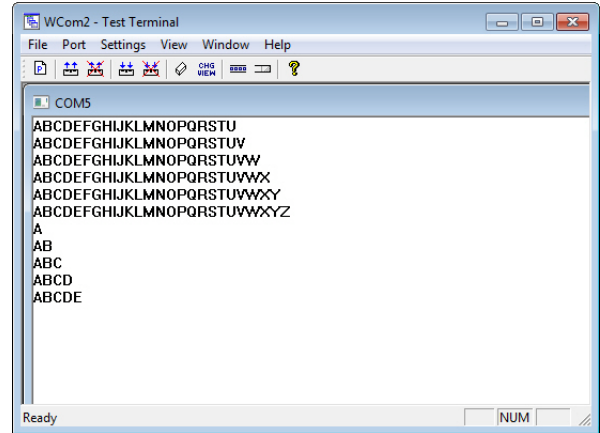

4. Select **Port > Send and Receive Test Data** to stop the scrolling data.
5. You can go to the next procedure to run the *Loopback Test* on Page 164 if this is an RS-232 port.

If this test successfully completed, then the port is operational as expected.

Note: *Do NOT forget to restart the communications application.*

Loopback Test (RS-232)

The **Loopback Test** tests the modem control (hardware handshaking) signals. It only has meaning in RS-232 mode on serial connector interfaces with full RS-232 signals. If performed under the following conditions, the test will always fail because full modem control signals are not present:

- RS-422
- RS-485
- RJ11 connectors

Use the following steps to run the Loopback Test.

1. If necessary, start Test Terminal (Page 163, [Steps 1](#) through [2](#)).
2. Click **Port > Loopback Test**.

This is a pass fail test and will take a second or two to complete. Repeat for each port that needs testing.

If the Loopback Test and the Send and Receive Test Data tests successfully complete, then the port is operational as expected.

Sending and Receiving Data (RS-485: 2-Wire)

This procedure shows how to use Test Terminal (WCom2) to test two RS-485 (2-Wire, Half-Duplex) ports.

1. In PortVision DX, click **Tools > Applications > Test Terminal (WCom2)** to start Test Terminal.
2. Open two ports RS-485 ports. This example uses COM40 and COM41.

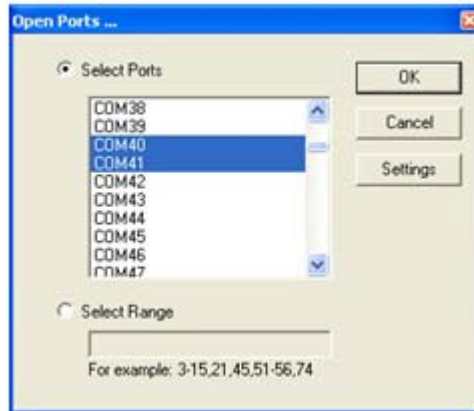

Test Terminal will open two windows, note that both ports show *Receiving* on the status bar.

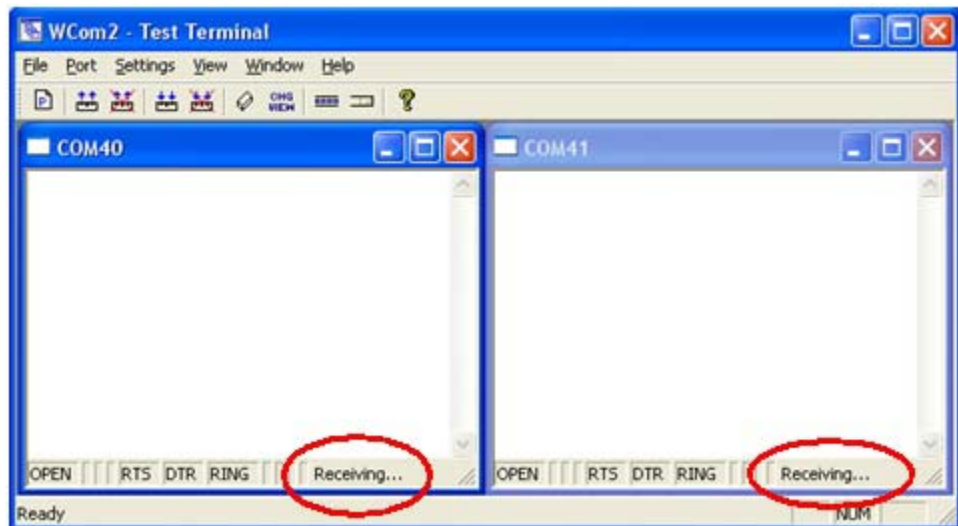

3. Right-click in both COM windows and remove the check mark for **Receive**.

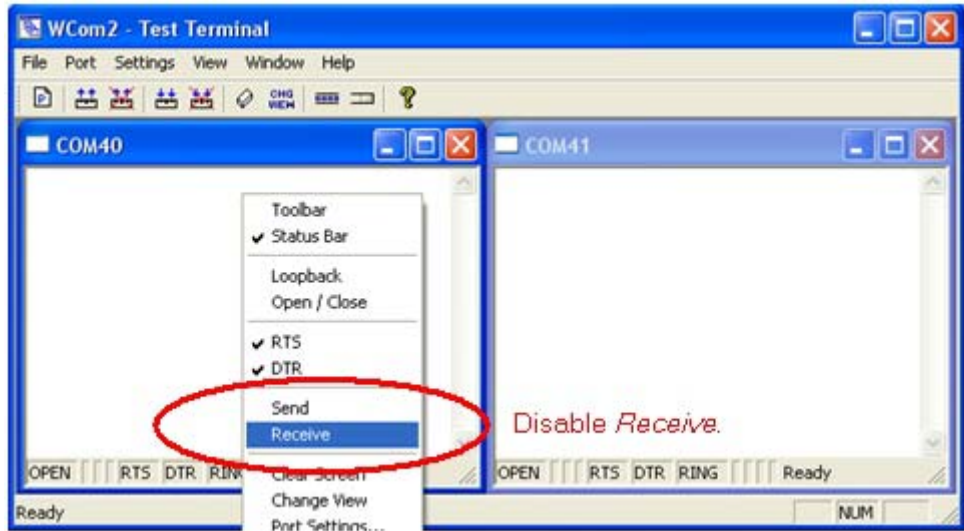

Both COM ports show *Ready* on the status bar.

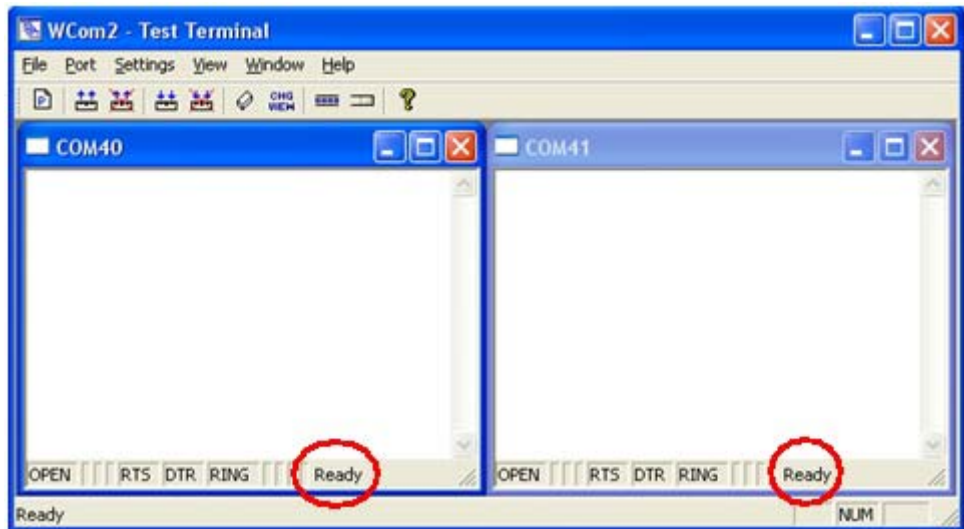

4. Right-click in ONE window and select the **Receive** option from the pop up.

- Right-click the OPPOSITE window and click Send.

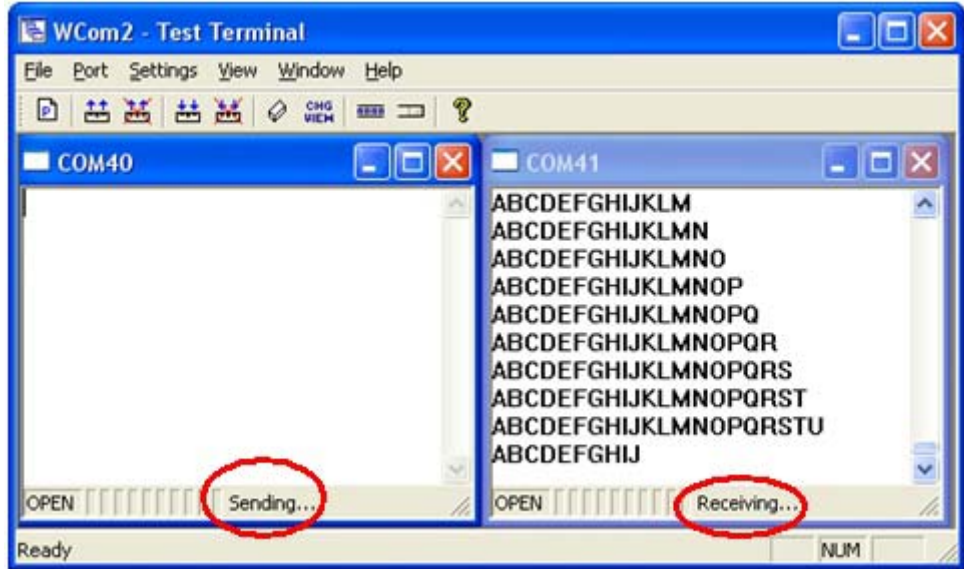

The *Status* line shows *Sending* or *Receiving*. In this case, COM40 is sending data and COM41 is receiving the data which is visually confirmed by the data scrolling across the COM41 window.

Note: If you do not see the data being received it *MAY* be necessary to also disable the *RTS* and *DTR* options from the right-click pop-up menu in each COM port.

- Right-click and remove the check mark on the *Sending* COM port.
- Right-click and remove the check mark on the *Receiving* COM port.

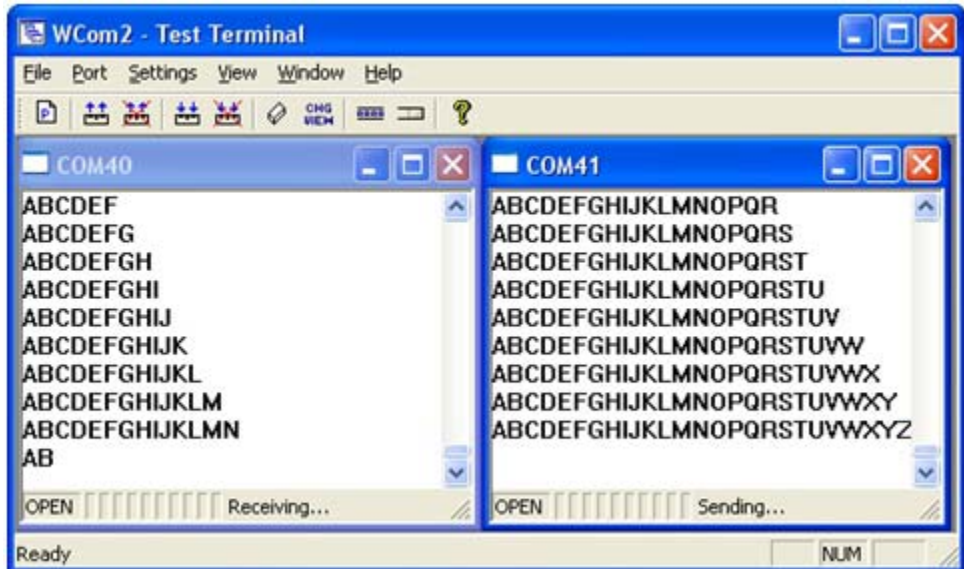

Neither COM port is sending or receiving data but shows *Ready* on the *Status* bar.

- Reverse the sending/receiving windows one at a time. Set the **Receive** option first, then in the opposite window, select the **Send** option.

The *Status* line shows *Sending* or *Receiving* in the reverse windows.

Data is now scrolling in the COM40 window. COM41 is static as it is not receiving data but transmitting data.

Socket Mode Serial Port Testing

This procedure illustrates using Putty, which is available in PortVision DX. Optionally, you can use any other Winsock compatible application.

Note: The following procedure starts with resetting DeviceMaster to factory default values. You may want to save the DeviceMaster socket configuration using [Saving a SocketServer Configuration File](#) on Page 117.

1. If necessary, install PortVision DX using [Installing PortVision DX](#) on Page 37 and scan the network to locate the DeviceMaster that you want to test.
2. Right-click the DeviceMaster and click **Webpage**.
3. Scroll to the bottom of the home page and click **Reboot**.

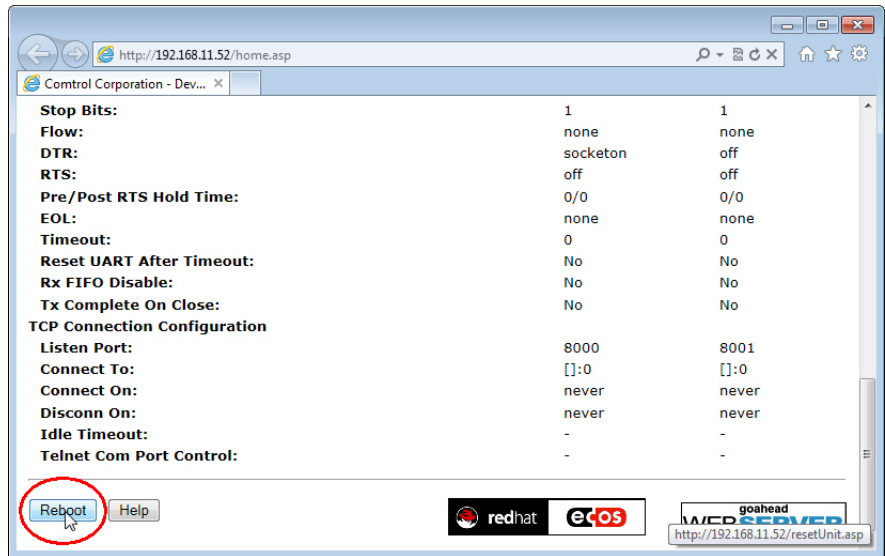

4. Click the **Set configuration for all ports to factory default settings** option and then click the **Yes Reboot** button.



- If necessary, re-open the web pages and click on the port that you want to test. The following example tests Port 1.

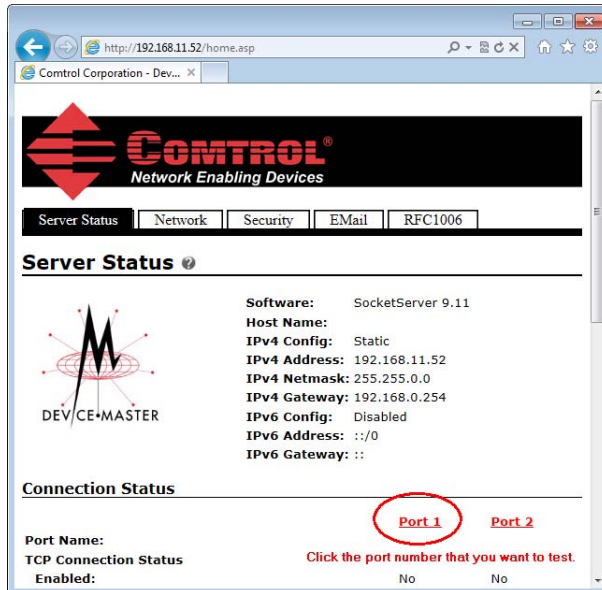

- Scroll down *TCP Connection Configuration* options, click the **Enable** option, and leave all other settings on this page at their default values.

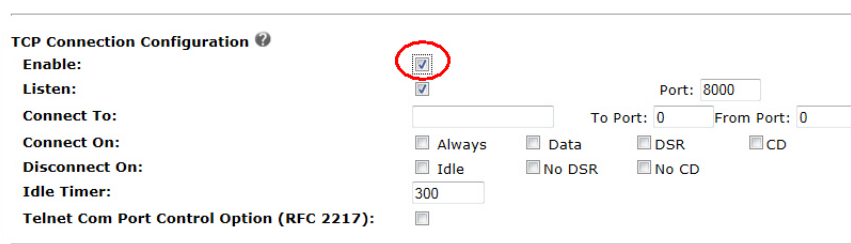

Note the Port number as it is needed later in this procedure. In this example, the port number is 8000.

- Scroll to the bottom of the page and click the **Save** button.
- Click **Ok** when the *Port Configuration Updated* page appears.

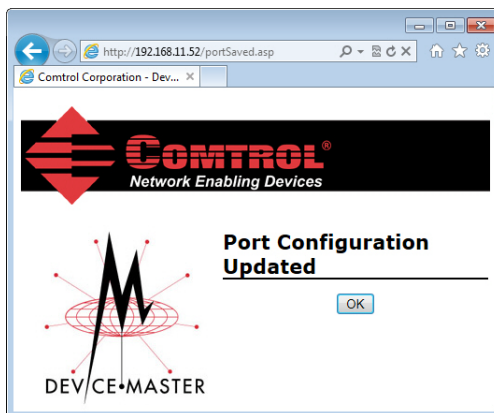

- Verify that the port has been enabled.

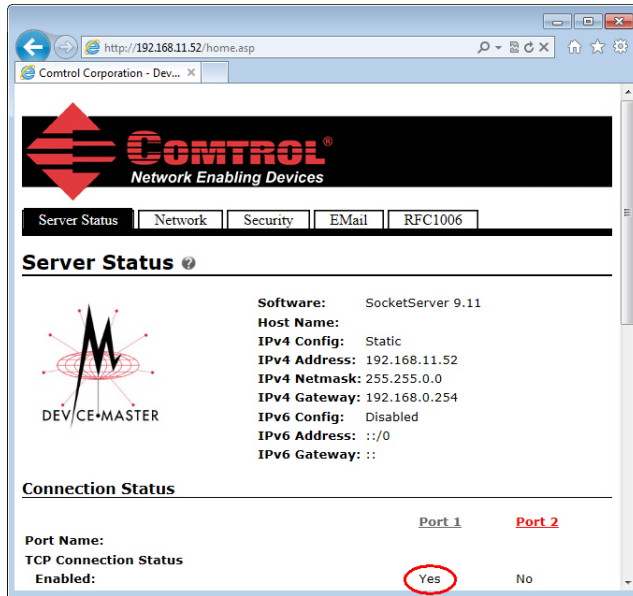

- Leave the web page open.
- Attach the loopback plug that was shipped with the DeviceMaster to the serial port of the DeviceMaster. See [Connecting Serial Devices](#) on Page 95 if you need to build a loopback plug.
- Right-click the DeviceMaster in the *Device List* pane and click **Telnet / SSH Session**.

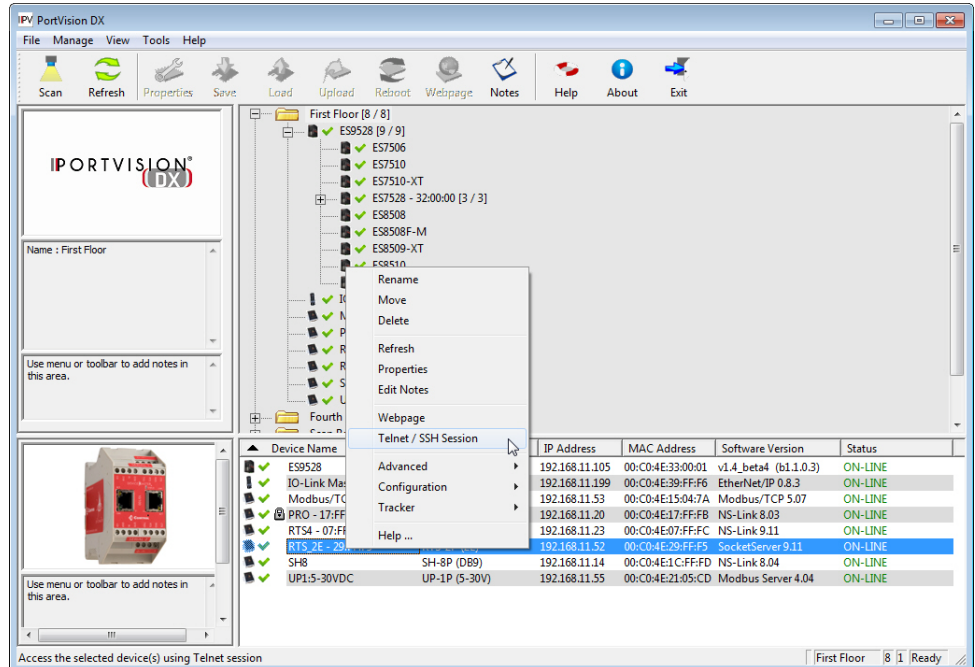

13. Enter the socket number of the port that you are testing ([Step 6](#)) and click **Ok**.

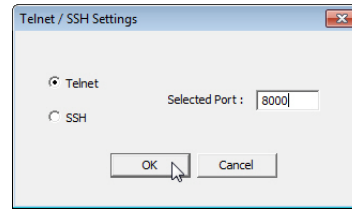

PuTTY loads.

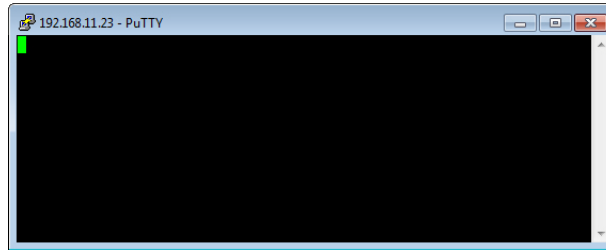

14. Type 123.

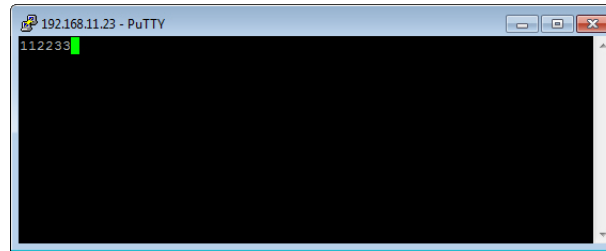

If 112233 displays, you need to disable local echo. Use the following steps to disable local echo.

- Go to `c:\Program Files (x86)\Control\PortVision DX`.
- Execute **PUTTY.EXE** to open the application.

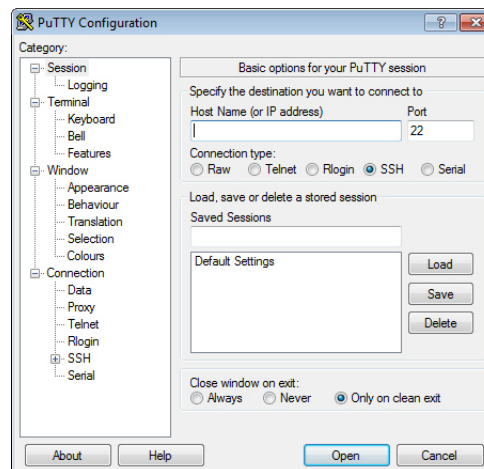

- c. Click **Terminal** and click **Force off** for the *Local echo* option.

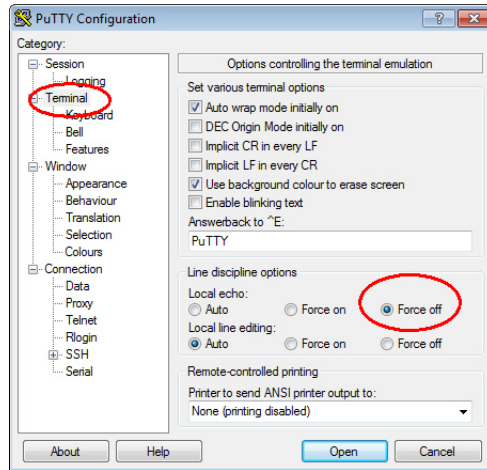

- d. Return to the **Session** menu, highlight **Default Settings** and then click **Save**.

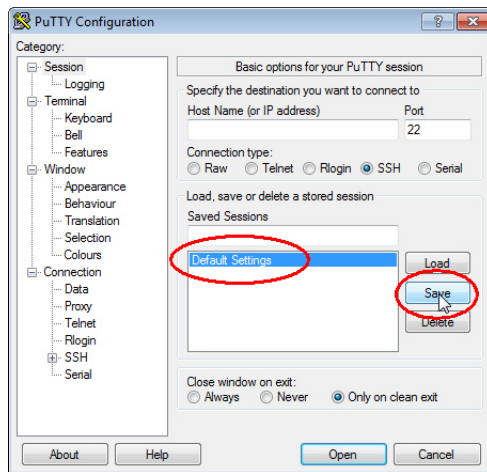

- e. Click **Cancel** to close PuTTY.
- f. Close the telnet (PuTTY) session that you opened from PortVision DX.
- g. Re-open the telnet session by right-clicking the DeviceMaster, and select the **Telnet / SSH Session** option.
- h. Enter the Socket Port number and then click **Ok**.

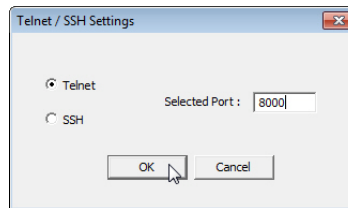

- i. Enter **123**, single digits should appear.

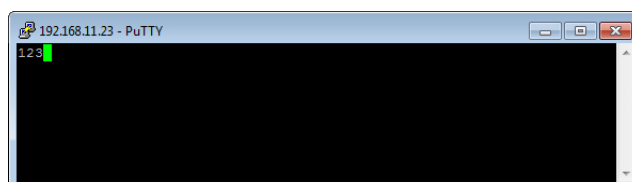

15. Remove the loopback plug and type **abc**. No characters should display because the return path is open.
16. Re-attach the loopback plug, type **abc**, and the characters should appear.

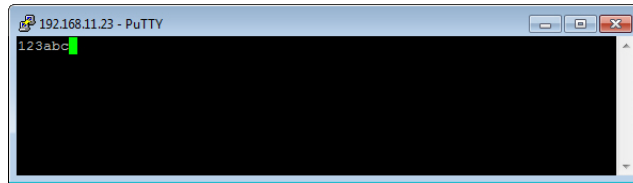

17. If you want to test additional ports, simply repeat this procedure on that port or ports.
18. Remove the loopback plug from the serial port and attach your serial device. You may need to set the serial parameters as necessary to match your attached equipment.

Daisy-Chaining DeviceMaster 2E/4/8/16-Port Units

The DeviceMaster 2E/4/8/16-port models with external power supplies follow the IEEE specifications for standard Ethernet 10/100BASE-TX topologies.

When using the **UP** and **DOWN** ports, the DeviceMaster 2E/4/8/16 is classified as a switch. When using the **UP** port only, it is a simple end node device.

The maximum number of daisy-chained DeviceMaster 2E/4/8/16 units, and the maximum distance between units is based on the Ethernet standards and will be determined by your own environment and the conformity of your network to these standards.

Control has tested with seven DeviceMaster 2E/4/8/16 units daisy-chained together using 10 foot CAT5 cables, but this is not the theoretical limit. You may experience a performance hit on the devices at the end of the chain, so it is recommended that you overload and test for performance in your environment. The OS and the application may also limit the total number of ports that may be installed.

Following are some quick guidelines and URLs of additional information. Note that standards and URLs do occasionally change.

- Ethernet 10BASE-T Rules
 - The maximum number of repeater hops is four.
 - You can use Category 3 or 5 twisted-pair 10BASE-T cables.
 - The maximum length of each cable is 100m (328ft).

***Note:** Category 3 or 5 twisted pair cables look the same as telephone cables but they are not the same. The network will not work if telephone cables are used to connect the equipment.*
- Fast Ethernet 100BASE-TX rules
 - The maximum number of repeater hops is two (for a Class II hub). A Class II hub can be connected directly to one other Class II Fast Ethernet hub. A Class I hub cannot be connected directly to another Fast Ethernet hub.
 - You must use Category 5 twisted-pair 100BASE-TX cables.
 - The maximum length of each twisted-pair cable is 100m (328ft).
 - The total length of twisted-pair cabling (across directly connected hubs) must not exceed 205m (672ft).

***Note:** Category 5 twisted pair cables look the same as telephone cables but they are not the same. The network will not work if telephone cables are used to connect the equipment.*

- IEEE 802.3 specification: A network using repeaters between communicating stations (PCs) is subject to the 5-4-3 rule of repeater placement on the network:
 - Five segments connected on the network.
 - Four repeaters.
 - Three segments of the 5 segments can have stations connected. The other two segments must be inter-repeater link segments with no stations connected.

Additional information may be found at <http://compnetworking.about.com/cs/ethernet1/> or by searching the web.

DeviceMaster LEDs

The DeviceMaster has network and port LEDs to indicate status. This subsection discusses:

- [TX/RX LEDs](#)
- [Network and Device LEDs](#) on Page 175

TX/RX LEDs

This subsection discusses RX and TX LEDs on the following products:

- DB9: DeviceMaster 4-port and 8-port models and the DeviceMaster Serial Hub 16-port.
- RJ45: DeviceMaster RTS 16-port and 32-port models and the DeviceMaster PRO 16-port.

Note: *The DeviceMaster 1-port and 2-port models do not have TX/RX LEDs.*

The RX (yellow) and TX (green) LEDs function accordingly when the cable is attached properly to a serial device.

- After power cycling the DeviceMaster, the RX/TX LEDs are off.
- The LEDs do not function as described until the port has been opened by an application. You can use Test Terminal to open a port or ports if you want to test a port or ports ([Testing Ports Using Test Terminal](#) on Page 162).
 - If the port is configured for RS-232/422 mode:
 - RX LEDs (yellow) are lit
 - TX LEDs (green) are lit when as the data exits the port
 - If the port is configured for RS-485 mode:
 - RX LEDs (yellow) are lit while receiving
 - TX LEDs (green) are lit during active data transmission

Network and Device LEDs

The LEDs indicate that the default DeviceMaster application, SocketServer is running or after driver installation, that the NS-Link driver loads. If you have loaded PortVision DX, you can check the DeviceMaster status on-line.

Ports	Model	Network LEDs
1	DeviceMaster RTS	<ul style="list-style-type: none"> The Status LED on the front of the unit is lit, which indicates that it has power and has completed the boot cycle. <i>Note: The Status LED flashes while booting and it takes approximately 15 seconds for the bootloader to complete the cycle. When the Bootloader completes the cycle, the LED has a solid, steady light that blinks approximately every 10 seconds.</i> The red Link Act LED is lit, which indicates a working Ethernet connection. If the red Duplex LED is lit, it indicates full-duplex activity. If the red 100 LED is lit, it indicates a working 100 MB Ethernet connection (100 MB network, only).
1	DeviceMaster RTS Embedded	<p>The LEDs are located between the RJ45 connector and the power terminal block.</p> <ul style="list-style-type: none"> The amber Status LED (D1) on the adapter is lit, which indicates that it has power and has completed the boot cycle. <i>Note: The Status LED flashes while booting and it takes approximately 15 seconds for the bootloader to complete the cycle. When the Bootloader completes the cycle, the LED has a solid, steady light that blinks approximately every 10 seconds.</i> The red Link Act LED (D2) is lit, which indicates a working Ethernet connection. If the red Duplex LED (D3) is lit, it indicates full-duplex activity. If the red 100 LED (D4) is lit, it indicates a working 100 MB Ethernet connection (100 MB network, only).
2	DeviceMaster RTS	<ul style="list-style-type: none"> The STATUS LED on the device is lit, indicating you have power and it has completed the boot cycle. <i>Note: The STATUS LED flashes while booting and it takes approximately 15 seconds for the Bootloader to complete the cycle. When the Bootloader completes the cycle, the LED has a solid, steady light that blinks approximately every 10 seconds.</i> If the LINK (green) LED is lit, it indicates a working Ethernet connection. If the ACT (yellow) LED flashes, it indicates network activity.
4 8 16	DeviceMaster PRO (8) DeviceMaster RTS† DeviceMaster Serial Hub (8)	<ul style="list-style-type: none"> The PWR LED on the front of the unit is lit, which indicates it has power and has completed the boot cycle. <i>Note: The PWR LED flashes while booting and it takes approximately 15 seconds for the bootloader to complete the cycle. When the Bootloader completes the cycle, the LED has a solid, steady light that blinks approximately every 10 seconds.</i> The red LNK/ACT LED is lit, which indicates a working Ethernet connection. If the red 100 LED is lit, it indicates a working 100 MB Ethernet connection (100 MB network, only).

Ports	Model	Network LEDs
16	DeviceMaster PRO (16)	<ul style="list-style-type: none"> The Status LED on the front of the unit is lit, which indicates it has power and has completed the boot cycle. <p>Note: <i>The Status LED flashes while booting and it takes approximately 15 seconds for the bootloader to complete the cycle. When the Bootloader completes the cycle, the LED has a solid, steady light that blinks approximately every 10 seconds.</i></p>
32	DeviceMaster RTS†† Serial Hub (16)	<ul style="list-style-type: none"> The red LNK/ACT LED is lit, which indicates a working Ethernet connection. If the red Duplex LED is lit, it indicates full-duplex activity. If the red 100 LED is lit, it indicates a working 100 MB Ethernet connection (100 MB network, only).
<p>† External power supply. †† Internal power supply.</p>		

Removing DeviceMaster Security Features

When presented with a DeviceMaster that has had all security options set and the user is unaware of what the settings are, the restoring of a DeviceMaster can be very difficult.

It may be necessary to use the DeviceMaster debug dongle provided with the *Software Developers Kit* (SDK) or return the DeviceMaster to Control after obtaining an return material authorization (RMA) so that Control can re-flash the DeviceMaster with default values.

One of the following two conditions must be true, so that you can remove the security settings from the DeviceMaster.

- Serial connection using Port 1 to access RedBoot:
 - Bootloader timeout set to value greater than 10 seconds (default is 15 seconds).
 - A known good null modem cable.
 - A COM port on PC/Laptop.
- Bootloader *Command Console* using an Ethernet connection
 - No password or a known password.
 - A known or discoverable IP address.
 - A utility such as *Angry IP Scanner* from www.angryip.org may be used to discover IP addresses. If the IP range is unknown, a full scan from 0.0.0.1 to 255.255.255.255 may take a long time.
 - An Ethernet cable.
 - A PC/Laptop with a telnet application installed such as PuTTY included in PortVision DX.

Serial Connection Method

Use the following procedure to set up serial connection with a terminal server program (for example, Test Terminal (WCom2), HyperTerminal or Minicom) and the DeviceMaster.

Note: *Optionally, you can use Test Terminal, which is included in PortVision DX under the **Tools > Applications > Test Terminal** menu.*

1. Connect a null-modem cable from an available COM port on your PC to **Port 1** on the DeviceMaster.

Note: See [Connecting Serial Devices](#) on Page 95 to build a null-modem cable.

2. Configure the terminal server program to the following values:

- Bits per second = 57600
- Data bits = 8
- Parity = None
- Stop bits = 1
- Flow control = None

3. Reset the DeviceMaster.

Note: *Depending on the model, disconnect and reconnect the power cable (external power supply and no power switch) or turn the power switch on and then off (internal power supply).*

4. Immediately type **#!DM** and press **Enter** in the terminal program.

5. At the **RedBoot>** prompt, type **dis**, and press **Enter**.

Note: *If you do not disable the loading feature of the Bootloader within the time-out period (default is fifteen seconds), an application will be loaded from flash and*

```
#!DM
RedBoot>dis
Loading disabled
```

started. If this happens, repeat Steps 3 through 5. The #!DM command is the only case-sensitive command and must be in uppercase.

6. Enter **password** and press **Enter**, which clears the existing password.
7. Enter **auth none** and press **Enter**, which removes the authentication level.
8. If you do not know the IP address, enter **ip** and press **Enter**.
9. Enter **timeout 15** and press **Enter**, which sets a reasonable timeout value.

Note: If the Bootloader timeout has been set too low to allow console port access, and the IP address cannot be discovered, then the DeviceMaster must be returned to Control for re-flashing.

10. Connect the DeviceMaster directly to the PC/laptop running PortVision DX.

Note: If necessary, see [Installing PortVision DX](#) on Page 37.

11. Open PortVision DX.
12. Scan the network so that PortVision DX discovers the DeviceMaster.
13. Right-click the DeviceMaster and then click **Telnet/SSH Session**.

```

RedBoot> dis
Loading disabled
RedBoot> password
Cleared
RedBoot> auth none
Auth: none
RedBoot> IP

IP:      192.168.11.40
Mask:    255.255.255.0
Gateway: 192.168.11.1

RedBoot> timeout 15
Timeout 15 seconds
RedBoot>
    
```

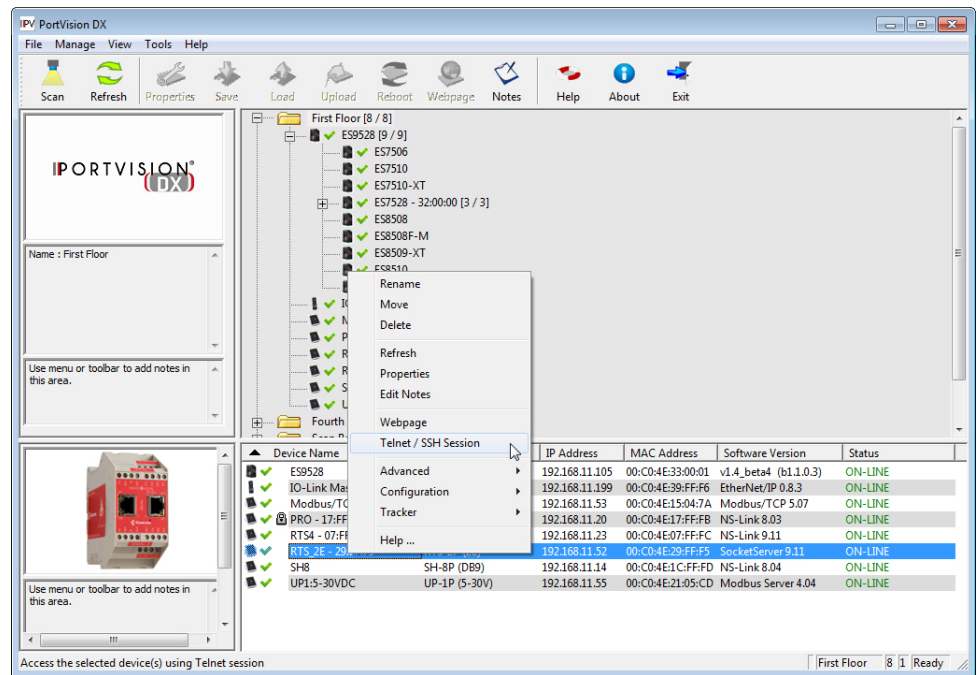

14. Click **Telnet**, leave Port 23 as the *Selected Port* and click **Ok**

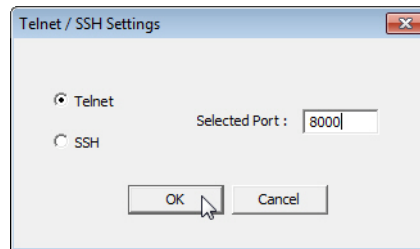

15. Press **Enter** at the *Password* prompt.
 16. Enter **secureconf disable** and press **Enter**.
 17. Enter **securedata disable** and press **Enter**.

```

192.168.11.40 - PuTTY
Password:
Control DeviceMaster RTS ModelID: 5002111

SocketServer 7.31
Built: Tue Aug 30 10:19:00 CDT 2011
IP Addr: 192.168.11.40, Mask: 255.255.255.0, Gateway: 192.168.11.1
MAC Addr: 00:c0:4e:07:ff:fc

dm> secureconf disable
SecureConfig is disabled

dm> securedata disable
SecureData is disabled

dm>
  
```

Returning the DeviceMaster to Factory Defaults

The DeviceMaster uses two types of memory, volatile and non-volatile. The volatile memory is in the form of DRAM and SRAM. They are used for program execution and buffers. Clearing the volatile memory, as its name suggests, requires powering off the DeviceMaster.

The non-volatile memory is in the form of flash and EEPROM memories.

The flash memory is used for non-volatile program storage. Leaving the factory, there are two programs stored in the flash:

- **Bootloader binary (bootloader.bin)**
The bootloader binary is loaded into DRAM for execution, when the device is turned on. After a period of time, the bootloader loads the default application,
- **Default application binary (SocketServer.bin)**

SocketServer.bin or in some instances, a customer written custom application, into DRAM and it starts execution. It continues until the unit is powered off.

The only access you have to the binaries is if they decide to load a newer version. If this is done, the newer version overwrites that piece of flash. No user data is ever entered here.

The EEPROM memory is programmed with a number of default values. The values that you can modified are shown in the following table.

Parameter Name	Default Value	User Configurable	Web or Telnet	Console Port	Port
Authentication	None	Yes	No	No	Yes
IP Address	192.168.250.250	Yes	Yes	Yes	Yes
IP Mask	255.255.0.0	Yes	Yes	Yes	Yes
IP Gateway	192.168.250.1	Yes	Yes	Yes	Yes
Password	Blank	Yes	Yes	No	Yes
Telnet	Enable	Yes	Yes	Yes	Yes
Telnet Timeout	300 sec.	Yes	Yes	Yes	Yes
Bootloader Timeout	15 sec.	Yes	Yes	Yes	Yes
SNMP	Enable	Yes	Yes	Yes	Yes
SSL†	Disable	Yes	Yes	Yes	Yes

† SSL is a security feature available with SocketServer v7.00 and later.

Clearing the Flash

The flash only has program binaries. There is no user data stored in the flash. If it is necessary to erase the binaries, the default application (**SocketServer.bin**) can be erased using the **fis init** command from the DeviceMaster using a serial connection, that is Port 1 through a null-modem cable and a COM port.

See [Establishing a Serial Connection](#) on Page 134 ([Steps 1](#) through 6) to access RedBoot and enter **fis init -f** at the RedBoot prompt.

There is no easy way to remove the bootloader binary. Removal of the bootloader binary would leave the DeviceMaster inoperable and require that it be returned to the factory to be reprogrammed.

Clearing EEPROM

The user configurable values in the EEPROM, can be accessed and set in three different ways. All of the values can be set using a serial connection (Port 1 with a null-modem cable connected to a COM port). Most of the values can be accessed by using the Web Server (SocketServer or NS-Link equivalent) or telnet. Refer to the appropriate procedure for your situation:

- [Telnet Access](#)
- [Serial Port Access](#) on Page 181
- [Web Server Access](#) on Page 181

Telnet Access

Use this procedure to access the DeviceMaster configuration through telnet,

Note: To reset authentication, see [Serial Port Access](#) on Page 181 or use the [RedBoot Command Overview](#) on Page 141.

1. Open a telnet session, enter the DeviceMaster IP address. If using Windows, open a **Command** window and type **telnet [ip_address]**.
Note: Press the **Enter** key if you have not programmed a password or use the password previously configured. The DeviceMaster does not come pre-programmed with a password.
2. To return the IP address to the default value, type **ip 192.168.250.250 255.255.0.0 192.168.250.1** and press **Enter**.
3. To reset the password, type **password** and press **Enter**.
4. To reset the telnet timeout value, type **teltimeout 300** and press **Enter**.

5. To reset the bootloader timeout value, type **timeout 15** and press **Enter**.
6. To enable SNMP, type **snmp enable** and press **Enter**.
7. To disable SSL, type **ssl disable** and press **Enter**. The SSL command is only available on DeviceMaster products running SocketServer 7.0 and later.

Serial Port Access

To use the serial method to access the DeviceMaster configuration, use [Establishing a Serial Connection](#) on Page 134. Once the connection is established, use the following commands to reset the factory default values.

1. To reset the authentication, type **auth none** and press **Enter**.
2. To return the IP address to the default value, type **ip 192.168.250.250 255.255.0.0 192.168.250.1** and press **Enter**.
3. To reset the password, type **password** and press **Enter**.
4. To reset the telnet timeout value, type **teltimeout 300** and press **Enter**.
5. To reset the bootloader timeout value, type **timeout 15** and press **Enter**.
6. To enable SNMP, type **snmp enable** and press **Enter**.
7. To disable SSL, type **ssl disable** and press **Enter**. The SSL command is only available on DeviceMaster products running SocketServer 7.0 and later.

Web Server Access

You can optionally use SocketServer (or the NS-Link equivalent) to access the DeviceMaster configuration and reset many values to their default values.

Some of the values require resetting the DeviceMaster to take effect. After changing the IP addresses and resetting the DeviceMaster, it will not reconnect automatically. You will need to use the new IP address to reconnect.

Note: *The authentication method and the password cannot be changed using SocketServer.*

To reset authentication, see [Serial Port Access](#) on Page 181 or use the [RedBoot Command Overview](#) on Page 141.

To reset the password, see [Configuring Passwords](#) on Page 140 or [Telnet Access](#) on Page 180.

1. Open your web browser and enter the IP address of the DeviceMaster.

Security Configuration

Enable Secure Data Mode	<input type="checkbox"/>
Enable Secure Config Mode	<input type="checkbox"/>
Enable Telnet/ssh	<input checked="" type="checkbox"/>
Enable Monitoring Secure Data via Telnet	<input type="checkbox"/>
Enable SNMP	<input type="checkbox"/>

2. Click the **Security** tab:
 - a. Verify that the **Enable Secure Data Mode** option is not checked.
 - b. Verify that the **Enable Secure Config Mode** option is not checked.
 - c. Verify that the **Enable Telnet/SSH** option is checked.
 - d. Verify that the **Enable Monitoring Secure Data via Telnet** option is not checked.
 - e. Verify that the **Enable SNMP** option is checked.
 - f. Click **Save**.
 - g. Click **OK** when reminded it is necessary to reboot to take effect.
3. Click the **Email** tab:
 - a. Verify that the **SMTP Server IP Address** is set to: 0.0.0.0.
 - b. Verify that all remaining options are clear.
 - c. Click **Save**.
 - d. Click **OK**.
4. Return to the *Server Status* (home) page and click **Reboot**.
5. Click **Set configuration for all ports to factory default settings**.

6. Click **Yes: Reboot**.
7. Click the **Network** tab and make the following changes:
 - a. Click the **Use static configuration below** check box and enter the following values:
 - Set the IP Address to 192.168.250.250.
 - Set the Netmask to 255.255.0.0.
 - Set the Gateway to 192.168.250.1.
 - Set the Bootloader Timeout to 15.
 - b. Click **Save**.
 - c. Click **OK** when reminded it is necessary to reboot to take effect.

The DeviceMaster reboots. When it starts running, everything will have been returned to factory default values. If you choose to verify the values, the IP address has been reset to 192.168.250.250.

Technical Support

If you are using an NS-Link driver for a Windows system, you should review the troubleshooting section in the *DeviceMaster Device Driver (NS-Link) User Guide for Windows* (Page 12) before contacting Technical Support.

It contains troubleshooting procedures that you should perform before contacting Technical Support since they will request that you perform, some or all of the procedures before they will be able to help you diagnose your problem. If you need technical support, use one of the following methods.

Control Contact Information	
Downloads	ftp://ftp.comtrol.com/html/default.htm
Web site	http://www.comtrol.com
Phone	(763) 957-6000