



chapter

3 *Same-Server Migration*



The same-server migration method allows you to upgrade the same v2.1x server on a 386-processor or higher to a v3.11 server. Using this method, you

1. Back up your data files;
2. Migrate the bindery information to the working directory on the local hard drive;
3. Install NetWare v3.11 on the server;
4. Restore the data files;
5. Migrate the translated bindery information to the v3.11 server.

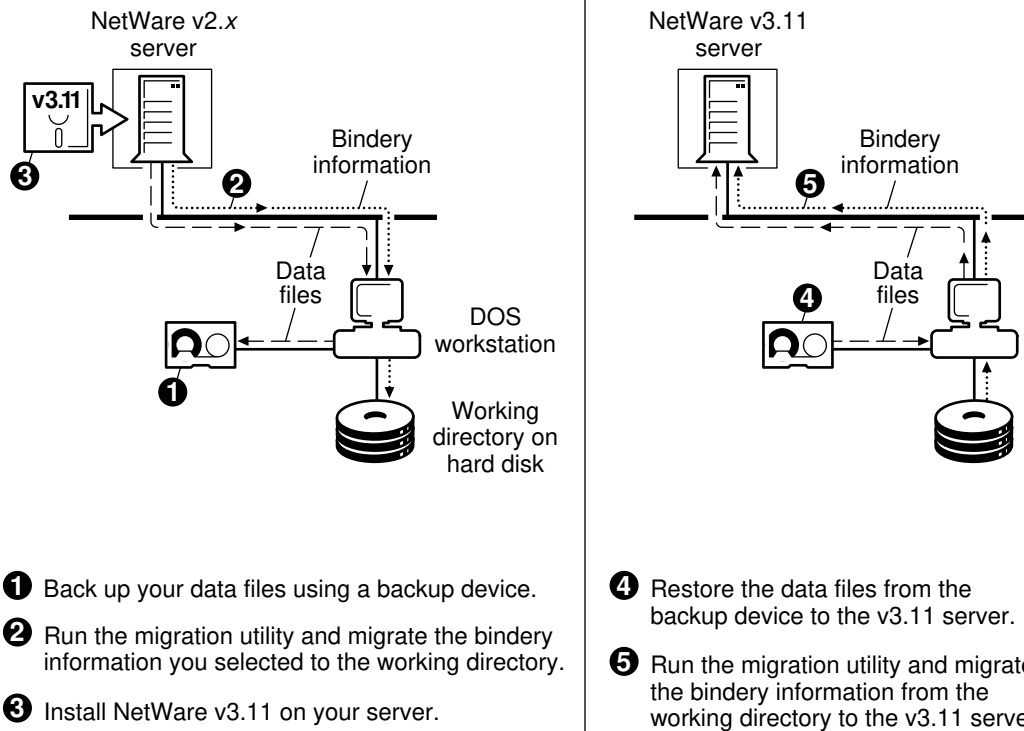
See Figure 3-1 for an illustration of this method.



BETA

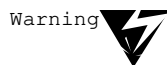


Figure 3-1
Same-server
migration



An advantage of using the across-the-wire method of migration is that you do not risk losing or damaging your data. It stays on your v2.1x server during the migration to the v3.11 server and after the migration is complete.

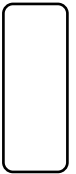
If you use the same-server migration method, you must remove the data files from the v2.1x server, remove the 286 partition, create a 386 partition, install NetWare v3.11, then restore your data files. This method does involve some risk to your data files.



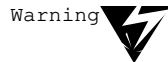
The *NetWare Migration Utility for v2.1x to v3.11* is not the same utility as UPGRADE that is documented in *NetWare v3.11 Installation*. Do not use the UPGRADE instructions.

3-2 Same-Server Migration

Migrate Using the Same-Server Migration Method



1. See "Before You Start" on page 1-7 and do the tasks that apply.
2. Make at least two full backups of your system that includes data files and bindery information in case you have to restore your v2.x system.



The NetWare v3.11 installation procedure destroys all data on your hard disk.

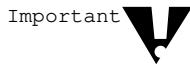
3. Run BINDFIX.

BINDFIX deletes mail subdirectories and trustee rights of all users who no longer exist on the network

For more information on BINDFIX, see your NetWare v3.11 manual set.

4. Make sure that all users are logged out of the server and that all files (except bindery files) are closed.

5. Back up the data files to a backup device.



Do not back up trustees or bindery information. The migration utility converts the trustees and bindery information to a v3.11 format.

Use this backup to restore the data files to the NetWare v3.11 server.

6. Start the migration utility by moving to the directory that contains the migration utility files and typing

MIGRATE <Enter>

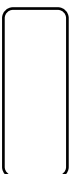
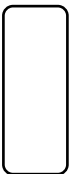
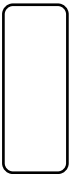
The "Select Migration Option" menu appears.

7. Select the Custom migration option.

The Custom migration option allows you to stop the utility after you migrate the bindery information to the working directory so that you can reformat your v2.1x server and install NetWare v3.11.

This option lets you select the types of information you want to migrate in order to customize the migration to your special needs.

BETA



BETA

For example, if you don't want to overwrite default account balances and restrictions, you do not have to migrate the default account balances and restrictions from the source server.

For more information on how to customize the destination server, see "Strategies for Merging Source Servers" on page 1-3.

See Figure 3-2 for an illustration of the Custom migration option.

3-4 Same-Server Migration

Figure 3-2
Using the Custom
migration option

```

1. Configure the Migration Utility ①
      Working Directory: C:\MIGRATE           (Default)
      Error/Warning Action: Pause after warnings and errors

2. Define the Source Server ② NetWare v2.x (v2.0a - v2.2)
      Server: <Press Enter to select server>
      Information to be migrated: <Press Enter to select information>
      Source volumes to migrate: <Press Enter to select volumes>

3. Define the Destination Server ③ NetWare v3.11
      Server: <Press Enter to select server>
      Volumes Destination: <Press Enter to specify destinations>
      Passwords: Assign random passwords
  
```



```

⑤ Select Migration Action
-----
|Migrate form NetWare v2.x to NetWare v3.11
|Migrate from NetWare v2.x to the Working Directory
|Migrate from Working Directory to NetWare v3.11
|View Migration Reports
|Exit (Return to DOS)
  
```

- ① Select a working directory.
- ② Define the source server.
- ③ Define the destination server.
- ④ After completing the form, press <F10> to start the migration.
- ⑤ Select an action and press <Enter>. (If you choose one of the first three actions, you are prompted to start the migration.)

BETA

8. Accept the default working directory, or specify another working directory.

The working directory is where the bindery information and the migration reports are stored.

Usually, the working directory is located on the hard disk drive of the workstation, but you can also locate it on a network drive. You need 5MB in this directory.

If you specify a directory that doesn't exist, the utility prompts you to have it created.

Follow the Quick Help to specify a new location for the working directory.

9. Press <Enter> to select a default error/warning action.

Error/Warning Action	Description
Pause after warnings and errors	Select this option if you want the utility to stop after each warning and error and prompt you to continue with the migration. Each time an error is reported and you are prompted, you can choose to discontinue the prompting.
Do not pause after warnings and errors	Select this option if you do not want to be prompted after each warning and error.

Important



All errors are listed in the report file regardless of the option you select.

10. Press <Enter> to display a list of file servers.
11. Select the source v2.1x server that you want to migrate, then press <Enter>.
- If the v2.1x server you want to select is not shown, follow the online help prompts to see a list of available servers that you can log in to.
12. Press <Enter> to display categories of information you want to migrate.

Important



- 13. Select the information you want to migrate, then press <Enter>.

You should not select the categories "All Information" or "Data Files," since you must transfer the data files using a separate backup; otherwise, select as many categories as you want.

Follow the Quick Help for details on how to select information.

See Table A-1 in Appendix A for a description of each category.

- 14. Press <Enter> to display a list of source volumes on the source v2.1x server that you want to migrate trustee assignments from.

- 15. Select the volumes using <F5>, then press <Enter>.

Select source volumes to migrate only if you are migrating information that is contained on those volumes. For example, you do not need to select a source volume if you are only migrating any of the following categories:

- Users
- User Restrictions
- Groups
- Default Account Balance/Restrictions
- Accounting Charge Rates
- Print Queues

You must select a source volume to migrate if you select the following category to migrate:

- Trustee Assignments

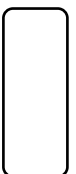
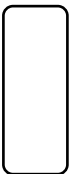
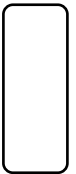
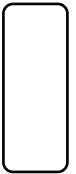
- 16. Review the fields on the migration utility screens and make any necessary corrections.

Do not complete the information for the destination server, since it does not yet exist. After you install NetWare v3.11 on your server, you return to this utility and complete the destination server information.

- 17. If you are ready to proceed with the migration, press <F10> to display the "Migration Action" menu.

- 18. Select "Migrate from NetWare 2.1x to the Working Directory," then press <Enter>.

You are prompted to begin the migration.

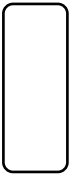


BETA

19. Select "Yes" to start the migration, or select "No" to return to the migration utility screen.
 - ◆ If you select "Yes," the bindery information you selected is copied to the working directory and translated into the NetWare v3.11 format.

All information about the migration is scrolled to the screen and entered into a report file, which you can review later.

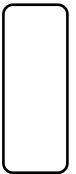
When the migration to the working directory is complete, the migration utility notifies you.
 - ◆ If you select "No," the migration utility screen appears. Make any necessary corrections, then press <F10> to select the migration action. Or, press <Esc> to exit the utility and return to the DOS prompt.



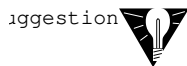
- 20. (Conditional) If errors occur during the migration, and you chose to be prompted after errors and warnings, you receive the following error message:

A migration error has occurred and is displayed in the migration log above. Do you want to continue with the migration?
(Y=Yes/N=No/I=Ignore Error)

If you select:	Then:
Yes	The migration continues. The error is written to the report file, and you are prompted again the next time an error occurs.
No	The migration stops. The error is written to the report file. You receive this message: Migration from the NetWare v2.x source server to the NetWare v3.11 destination server is finished. Press <Enter> to continue. Press <Enter> to return to the "Select Migration Action" menu. From there, press <Esc> to edit the fields, or select "Exit" to leave the utility and return to the DOS prompt.
Ignore	The migration continues. The error is written to the report file. You are no longer prompted when an error occurs, but all errors are written to the report file.



BETA

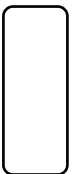
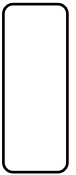


See Appendix C for explanations of error messages.

- 21. When the migration to the working directory is complete, press <Enter>.

The "Select Migration Action" menu appears.

- 22. (Optional) Select "View Migration Reports" to review the report file.



22a. Select the report for the migration you just did and press <Enter>.

The reports reside in the working directory that you specified earlier.

The report file is an ASCII text file that consists of the following:

- ◆ Summary information of the bindery import phase (migrating bindery data from the source server to the working directory).
- ◆ Listing of each item in each category that was read from the source server.
- ◆ The number of errors that occurred during the migration.

22b. Press <Esc> twice to return to the “Select Migration Action” menu.

23. Select “Exit (Return to DOS).”

Exit the utility and return to the DOS prompt.

24. Install NetWare v3.11 on your v2.1x server.

Follow the instructions in the chapter “File Server Installation” in *NetWare v3.11 Installation*.

Important



Prepare for Macintosh file support:

- ◆ If you want to store Macintosh files and folders on a NetWare v3.11 server, install *NetWare Services for Macintosh* (a separate Novell product) on the v3.11 server. This product provides native-mode support for Macintosh workstations that connect to the v3.11 server.
- ◆ You must also add name space support to any volume that needs to store files with long names. See “Name Space Support” in *NetWare v3.11 Installation* for instructions on how to do this.

25. Restore the data files from your backup device to the NetWare v3.11 server.

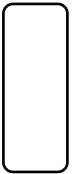
Make a note of where you restore the data files so that you can direct the bindery information to the correct location.

Important



Do not restore any trustees or bindery information; restore data files only.

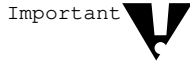
26. Start the migration utility again, by moving to the directory where the migration utility files are on the workstation and typing



MIGRATE <Enter>

- 27. Select the Custom migration option again.
- 28. Make sure that the working directory is the same one you used when you migrated from the source v2.1x server to the working directory.
- 29. (Optional) Change the Error/Warning prompt if necessary.
- 30. Move the cursor to "3. Define Destination Server—NetWare v3.11."

Complete the destination information to move the bindery information in the working directory to the new destination server.



Do not change the information in the source server area.

- 31. Press <Enter> to display a list of file servers.
- 32. Select the destination v3.11 server that you want to migrate the v2.1x server information to, then press <Enter>.

If the v3.11 server you want to select is not shown, follow the Quick Help at the bottom of the screen to see a list of available servers that you can log in to.

- 33. Press <Enter> to display a list of selected source volumes and their default destination volumes.

Destination volumes that match the source volumes are displayed as the default.

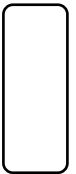
- 34. Select a volume and press <Enter> to specify the destination volume and directory on the v3.11 server.

Follow the Quick Help to see a list of available volumes and directories on the v3.11 server.

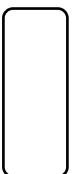
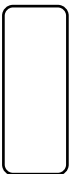
If you specify a directory that does not exist on the v3.11 server, you are prompted to have it created. Volumes must already be created.

- 35. Press < F10> when you have completed the destination path of the source volume.

- 36. Continue specifying destination paths for source volumes, or press <F10> if you are done.



BETA



37. Press <Enter> to select a password option.

See the following table for a description of the options.

Password Option	Description
Assign random passwords (Default)	<p>A password for each username that is migrated is generated randomly and stored in a file (NEW.PWD) in SYS:SYSTEM on the destination v3.11 server.</p> <p>Note: New passwords are given only to users and print servers that had a password on the source server.</p> <p>Only user SUPERVISOR or equivalent has access to this file. Users cannot log in until the supervisor gives them their password from this list.</p>
Assign no passwords	<p>After you finish the migration and bring up the new v3.11 server, all users who had a username on the v2.1x system can log in using their previous username. They are not prompted for a password.</p> <p>Note: Empty password expired only for user accounts that require a password.</p> <p>However, after they have logged in, they are prompted to type a new password, which the system verifies.</p>

Important



38. Review the fields on the migration utility screens and make any necessary corrections.

Do not change the information in the source server area.

39. If you are ready to proceed with the migration, press <F10> to display the "Select Migration Action" menu.

40. Select "Migrate from Working Directory to NetWare 3.11," then press <Enter>.

You are prompted to begin the migration.

41. Select "Yes" to start the migration, or select "No" to return to the migration utility screen.

- ◆ If you select "Yes," the bindery information you selected and trustee information (if specified) is copied from the working directory to the NetWare v3.11 server.

All information about the migration scrolls to the screen and goes into a report file, which you can review later.

When the migration from the working directory is complete, the migration utility notifies you.

- ◆ If you select "No," the migration utility screen appears. Make any necessary corrections, then press <F10> to select the migration action. Or, press <Esc> to exit the utility and return to the DOS prompt.

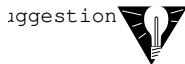


BETA

42. (Conditional) If errors occur during the migration, and you chose to be prompted after errors and warnings, you receive the following error message:

```
A migration error has occurred and is
displayed in the migration log above. Do you
want to continue with the migration?
(Y=Yes/N=No/I=Ignore Error)
```

If you select:	Then:
Yes	The migration continues. The error is written to the report file, and you are prompted again the next time an error occurs.
No	The migration stops. The error is written to the report file. You receive this message: Migration from the NetWare v2.x source server to the NetWare v3.11 destination server is finished. Press <Enter> to continue. Press <Enter> to return to the "Select Migration Action" menu. From there, press <Esc> to edit the fields, or select "Exit" to leave the utility and return to the DOS prompt.
Ignore	The migration continues. The error is written to the report file. You are no longer prompted when an error occurs, but all errors are written to the report file.



See Appendix C for explanations of error messages.

43. When the migration is complete, press <Enter>.

The “Select Migration Action” menu appears.

44. (Optional) Select “View Migration Reports” to review the report file.

44a. Select the report for the migration you completed and press <Enter>.

The reports reside in the working directory that you specified earlier.

Use the report to help you complete and customize definitions, attributes, and access privileges on the v3.11 server. If you find errors on your destination server after the migration, review the migration report to see if you can find where they occurred.

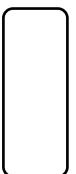
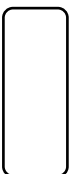
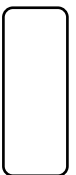
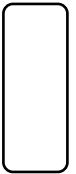
The report file is an ASCII text file that consists of the following:

- ◆ Summary information of the bindery import phase (migrating bindery data from the source server to the working directory).
- ◆ Listing of each item in each category that was read from the source server.
- ◆ Summary information of the bindery export phase (migrating bindery data from the working directory to the destination server).
- ◆ Listing of each item in each category that was written to or created on the destination server.
- ◆ The number of errors that occurred during the migration.

44b. Press <Esc> twice to exit the report.

45. Select “Exit (Return to DOS).”

Exit the utility and return to the DOS prompt.



BETA

After the Migration

After the migration is complete, check the v3.11 server and do the following if they apply:

- ◆ Examine any references to the server in the user login scripts if you changed the server name. While user login scripts are migrated, they are not modified and server names and directory paths are not changed to match your new environment.
- ◆ Check third-party applications in case you need to reinstall them before they will work properly. You may also need to enter new paths in the setup files for any third-party applications.
- ◆ Examine migrated print queues and print servers to make sure they are pointing to the right devices.
- ◆ Check user restrictions and accounting charge rates to make sure your system is configured the way you want it.
- ◆ Set any new directory and file attributes.
- ◆ If you chose to assign random passwords, you may want to print the NEW.PWD file and distribute the old password information to your users. The users should change their passwords immediately. The report, an ASCII text file, shows passwords sorted by date. If users were migrated from more than one server, the current password is the last one listed on the report.

BETA

End of Chapter