

# Ericsson GH198

Digital Handheld Telephone  
for GSM

# User's Manual

**ERICSSON** 

This manual is published by **Ericsson Mobile Communications AB**, without any warranty. Improvements and changes to this manual necessitated by typographical errors, inaccuracies of current information, or improvements to programs and/or equipment, may be made by **Ericsson Mobile Communications AB**, at any time and without notice. Such changes will, however, be incorporated into new editions of this manual.

All rights reserved.

© **Ericsson Mobile Communications AB**, 1993.

INNOVATRON PATENTS

**APPROVED** for connection to telecommunication systems specified in the instructions for use subject to the condition set out in them.



**S/1208/4/P/502763**

## SAFETY AND PRECAUTIONS

- **Switch off** your cellular telephone when in an aircraft. The use of cellular telephones in an aircraft may be dangerous to the operation of the aircraft, disrupt the cellular network and is illegal. Failure to observe this instruction may lead to suspension or denial of cellular telephone services to the offender, or legal action, or both.
- Users are advised to **switch off** the cellular telephone when at a refuelling point.
- Users are reminded of the need to observe restrictions on the use of radio equipment in fuel depots, chemical plants, or where blasting operations are in progress.
- A hand-held microphone or telephone handset should not be used by the driver while the vehicle is moving, except in an emergency. You should only speak into a fixed, neck slung or clipped-on microphone when it would not

distract your attention from the road. Do not stop on the hard shoulder of a motorway to answer or make a call, however urgent.

- There may be a hazard associated with using your GSM telephone close to personal medical electronic devices, such as hearing aids and pacemakers.
- Operation of your GSM telephone close to other electronic equipment, such as televisions, radios and personal computers may cause interference.
- Use only Basic Charger **4213** and AC/DC Converter **4214**, Rapid Charger **4219**, or Multi Charger **4221** and AC/DC Converter **4222** with this telephone. Other usage will invalidate any approval given to this telephone and may be dangerous.

# CONTENTS

<b>Introduction</b>	<b>1</b>	<i>Alarm Signal</i>	18
<b>Basic Operation</b>	<b>6</b>	<i>Error Signal</i>	18
Making the Phone Ready for Use	6	<i>Confirmation Click</i>	18
<i>Attaching the Battery</i>	6	Visual Signals	18
<i>Unfolding the Antenna</i>	6	<b>Storing Numbers</b>	<b>19</b>
Turning the Phone On	6	Storing a Number (and Name)	19
Entering a Phone Number	8	<i>Memory Protection</i>	20
Making a Call	8	<i>Memory Full</i>	20
<i>Last Number Recall</i>	9	Erasing a Stored Number (and Name)	21
<i>International Calls</i>	9	<b>Recalling Numbers</b>	<b>22</b>
<i>Emergency calls</i>	10	Numeric and Alphabetic Mode	22
Receiving a Call	10	Recalling a Number Using Numeric Mode	22
<i>Unanswered Calls</i>	10	<i>Scrolling through the Memory</i>	22
Call Time Meter	10	<i>Alternative Method for Recalling a Number</i>	22
<i>Audible Call Timer</i>	11	<i>Speed Calling</i>	23
Volume Control	11	Recalling a Number Using Alphabetic Mode	23
Microphone Mute	11	<i>Scrolling through the Memory</i>	23
Scratch Pad	11	Reviewing the First Digits if a Recalled Number Contains More than 10 Digits	23
Key Lock	11	Appending Digits to a Recalled Number	24
Turning the Phone Off	11	Replacing the Last Digits of a Recalled Number	24
<b>Details on the Display and Keys</b>	<b>12</b>	<b>Dialling Memory and Scratch Pad</b>	<b>25</b>
Display	12	Dialling Memory	25
<i>Alphanumeric Field</i>	12	<i>Recalling the Last Six Numbers Called</i>	25
<i>Numeric Field</i>	12	Scratch Pad	25
<i>Status Indicators</i>	12	<i>Storing a Number</i>	25
Keypad	14	<i>Recalling a Number</i>	26
Illumination	17	<b>DTMF Signalling</b>	<b>27</b>
Audible Signals	17	Sending DTMF Signals	27
<i>Ringling Signal</i>	17		

Sending a Code	27
Pre-programmed DTMF Signalling	27
<b>Special Functions</b>	<b>29</b>
Accessing a Special Function	30
<i>Using Method 1</i>	30
<i>Using Method 2</i>	30
<i>Using a Combination of the Two Methods</i>	31
<i>Leaving a Special Function</i>	31
Changing a Setting	31
Storing a New Setting	31
0. Ringing Signal Volume	32
1. Key Clicks, Silent Keypad or DTMF Signals	32
2. Call Forwarding	32
3. Call Barring	34
4. Automatic Re-try	36
5. Back Light	37
6. Current Network	37
7. Available Networks	37
8. Network Selection Mode	38
9. Automatic Network Selection	38
10. List of “Preferred” Networks	39
11. Last Call Time	40
12. Total Call Time	40
13. Minute Minder	40
14. PIN	41
15. Any Key	42
16. Language Selection	42
17. Area Code	42
18. Battery Discharge	43
19. Battery Voltage	43
20. Phone Lock	44

<b>Batteries and Recharging</b>	<b>46</b>
Batteries	46
<i>Battery Meter</i>	46
<i>Low Battery Alarm</i>	46
<i>Care and Maintenance</i>	47
<i>Inserting and Removing a Standard or Slimline Battery</i>	48
<i>Inserting and Removing a High-Capacity Battery</i>	49
Recharging	50
<i>Basic Charger</i>	51
<b>Accessories</b>	<b>53</b>
Hands-Free Vehicle Kit	53
Portable Hands Free	54
Vehicle Power Adaptor and Rapid Charger	55
Multi Charger	57
<b>Problems You Can Solve</b>	<b>60</b>
Phone Does Not Come On	60
<b>INSERT SIM</b> Is Displayed	60
The <b>SERV</b> Indicator Does Not Come On or the Message <b>NO NETW</b> (No Network) Is Displayed	60
The <b>SERV</b> Indicator Flashes	60
Received Signal Is Weak	60
Flashing Red Indicator Light – Alarm Signal Sounds	60
Steady Red Indicator Light	61
Changing Your Password	61
Messages	61
Inserting the SIM	62

# Introduction

This digital handheld cellular telephone is designed for use on a GSM (Global System for Mobile communications) network.

The GSM standard is the result of many years of collaboration between the telecommunications authorities of different European countries. This unique cooperation will result in GSM networks being installed all over Europe as well as in countries all over the world. This will allow you to use your phone wherever you travel, for business or pleasure.

The phone is small and light and simple to use. After you have turned it on, you can use it in much the same way as any other telephone.

The phone has an antenna which can be unfolded so that it points directly upwards and, when not in use, can be folded down completely.



*Before holding the phone to your ear, ensure that the antenna is unfolded completely.*

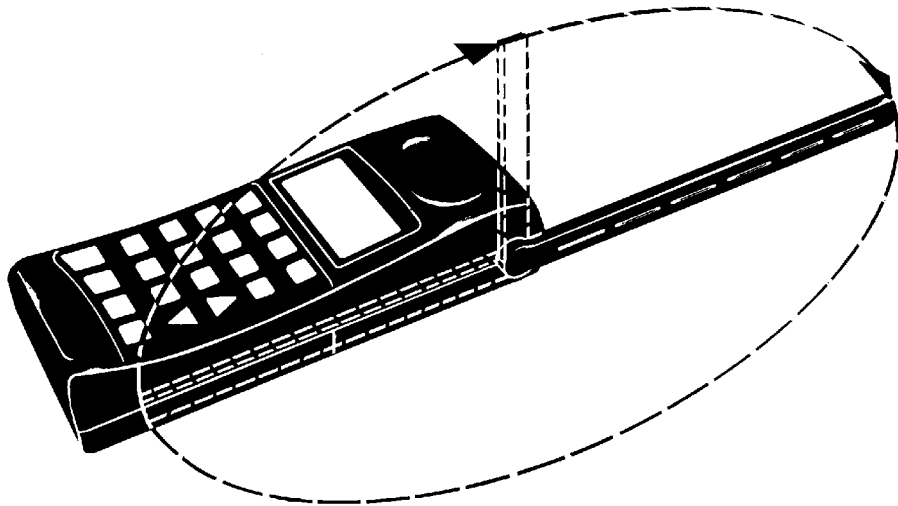

## ***About this manual***

This manual is provided to help you use your phone. Keep it handy to answer questions you may have.

The next chapter, ***Basic Operation***, describes the most essential operations: Turning the phone ON/OFF, making calls and answering calls.

Having learnt to perform these operations, you should read the third chapter, ***Details on the Display and Keys***, to learn more about the display, with its status indicators, and the functions of the various keys. The phone's audible and visual signals are dealt with, too.

Then you can go on to read about the more advanced functions, such as storing phone numbers and

accompanying names in memory, recalling phone numbers from memory, DTMF signalling, and using the Special Functions of the phone.

You should pay particular attention to the chapter ***Batteries and Recharging*** because correct care will prolong the life of a battery and also the length of time between recharging.

The ***Problems You Can Solve*** chapter at the end of the manual could save the cost of unnecessary service. It lists some simple things to be checked before calling for service personnel.

# Overview

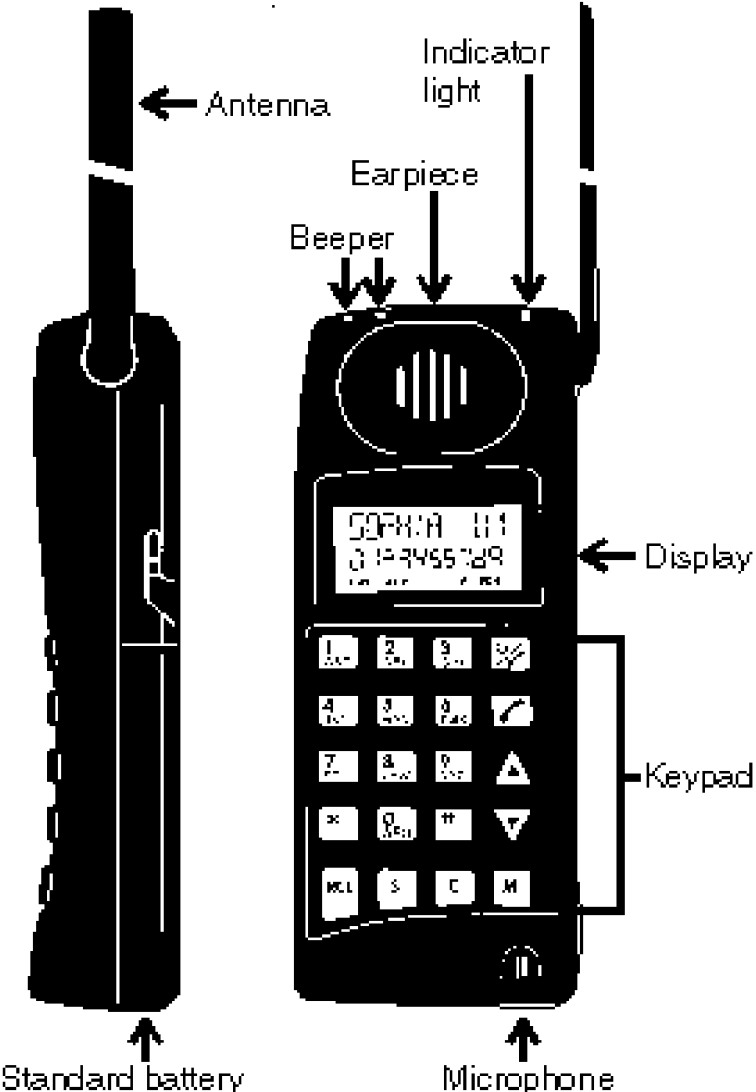



# Key functions

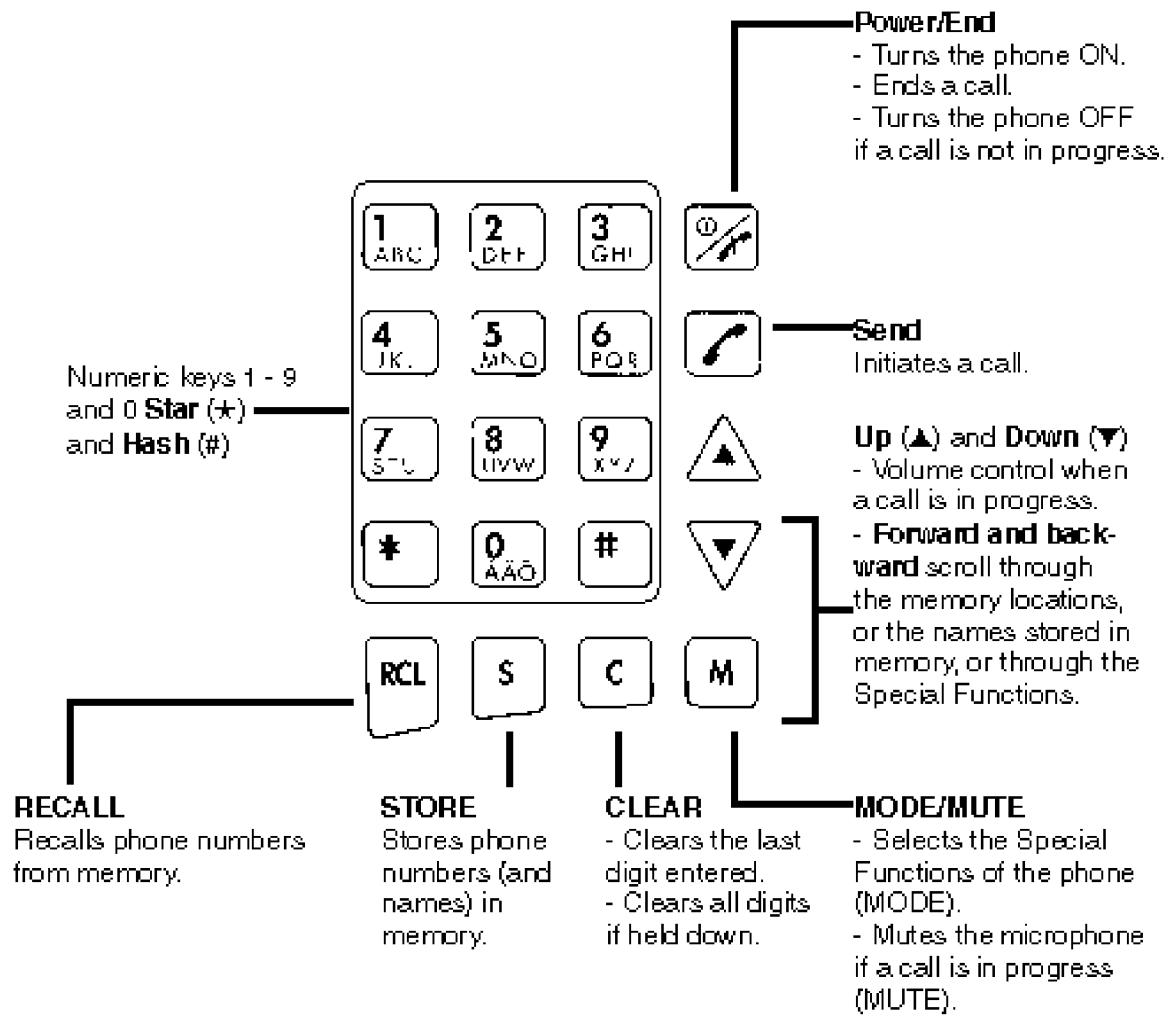

The function of the various keys are described in greater detail in the chapter *Details of the Display and Keys*.

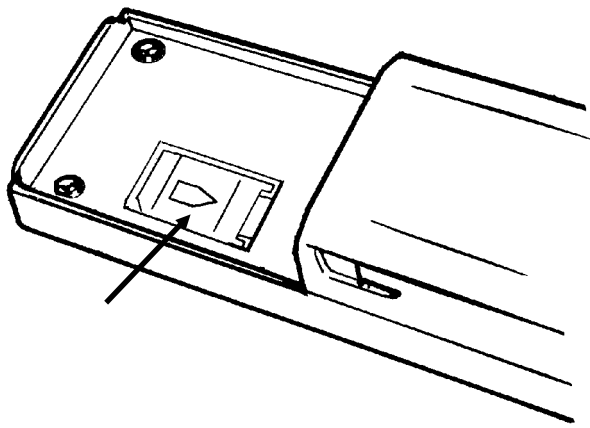

### ***SIM – Subscriber Identity Module***

Your SIM must be inserted. If not, you cannot use the phone.

The SIM contains your personal data, such as your subscriber number, your “home” network and services you have subscribed to.

It also comprises a memory where you can store frequently used phone numbers. Refer to the chapter ***Storing Numbers***.

### ***PIN – Personal Identification Number***

Your SIM is protected by a unique 4- to 8-digit PIN.

Special Function No. **14** allows you to decide whether or not this PIN must be entered each time the phone is turned ON.

This is called **PIN Check**. Refer to the chapter ***Special Functions***.

### ***Electronic lock***

Special Function No. **20, Phone Lock** allows you to enable an electronic lock to protect against unauthorized use of the phone in the event of a theft. Refer to the chapter ***Special Functions***.

### ***Observe the following!***

When you turn the phone ON for the first time, all texts in the display will be in **English**.

Special Function No. **16** allows you to select a language other than English. Refer to the chapter ***Special Functions***.

Some of the functions described in this manual are **optional**, and you may not have access to them.

### ***Additional information***

You should also read the operating instructions from your **network operator** about coverage areas and features as call barring and call forwarding.

# Basic Operation

## Making the Phone Ready for Use

### Attaching the Battery

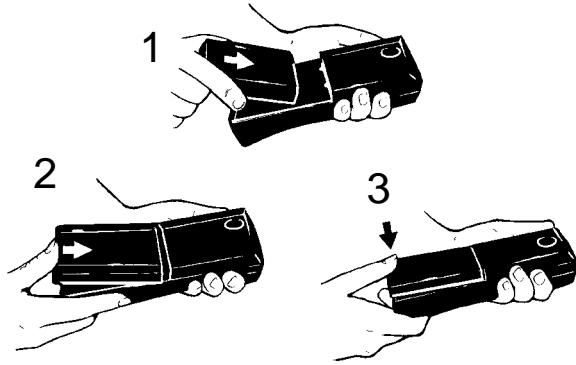

### Unfolding the Antenna

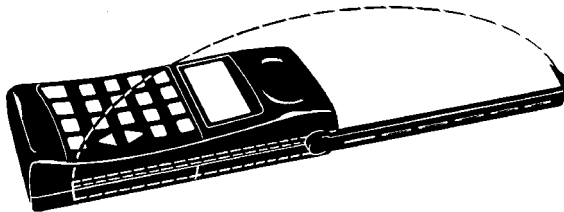

## Turning the Phone On



The phone is turned ON by pressing and **holding down** the **Power** key until a click is heard.

After the phone has been turned ON, the illumination of the display and keys comes on. All segments in the display flash for a few seconds. The **PWR** (Power) indicator then remains lit.

### **SIM not inserted**

*If your SIM is not already inserted, the message “**INSERT SIM**” appears in the display.*



Should this happen, refer to the chapter **Problems You Can Solve** at the end of this manual.

### **PIN check enabled**

*If the PIN check is enabled, to protect your SIM, the question “**PIN?**” appears.*



Enter your PIN on the numeric keys and press the # (Hash) key.



The SIM gives you three chances to enter the PIN correctly. If the PIN is entered incorrectly three times, the message “**SIM BLOCKD**” (SIM is blocked) is displayed.

Should this happen, refer to the chapter **Problems You Can Solve**.

After the PIN has been entered correctly, the phone searches for a GSM network and the message “**SEARCHING**” is displayed.

Once a GSM network has been found, three short beeps are heard and the **SERV** (Service) indicator comes on in the display. An abbreviation for the GSM network is displayed on the left of the display. You may now make and receive calls.

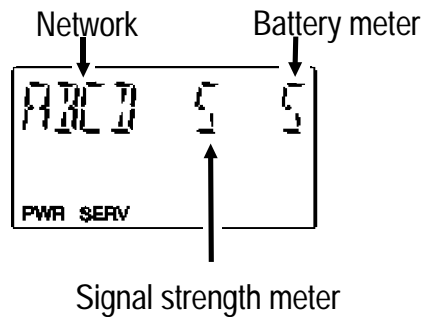

A **signal strength meter** shows the strength of the received signal, **0** to **5**. A value of **5** indicates a strong signal

A **battery meter** is shown on the right of the display. It starts at **5**, after a fully charged battery has been attached to the phone. As the battery loses charge, the battery meter

shows this in steps of 1, until **0** is shown when the battery has no charge left. You can read more about this in the chapter **Batteries and Recharging**.

**Note the following points:**

- The phone will search for the “home” network. If this is **not** available, the phone will search for a GSM network from those in range, provided that **Automatic Network Selection** is chosen.
- If **Manual Network Selection** is chosen, and the “home” network is not available, “**SEL NETW**” (Select Network) is displayed. Then you have to select a GSM network yourself. You can read more about this in the description of Special Function Nos. **7** and **9** in the chapter **Special Functions**.

**The SERV indicator flashes:**

This indicates that a GSM network is in range, but the phone will not register on that network. You can, however, make emergency calls. Refer to the section **Emergency Calls**, later in this chapter,

**The message “NO NETW” (No Network) is displayed:**

No network is available. The reason may be:

- You are in an area which is not covered by a network
- The received signal is too weak. Try moving the phone or the car to obtain a stronger signal. Refer to the chapter **Problems You Can Solve**.

## Entering a Phone Number



If anything is shown in the numeric field of the display, you must erase it before entering the phone number.

To erase the numeric field, hold down the **C** (CLEAR) key until the digits disappear.

A phone number to be called, or stored in memory, is entered on the numeric keys. The digits you enter are shown in the **numeric field** of the display.

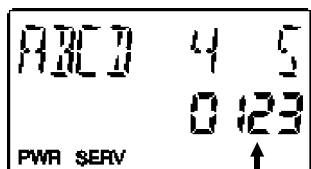

Numeric field

### **Always use the area code!**

Note that there are no local calls when you are calling from a cellular phone; you must always include the area code before the desired number. The only exceptions to this are certain cellular service numbers.



**Special Function No. 17, Area Code**, permits you to choose an area code that will be automatically added to a phone number if you do not enter an area code yourself. You can read more about this in the chapter **Special Functions**.

### **If you enter a wrong digit or a wrong number:**

If you enter a wrong digit, you can erase it by pressing **C** (CLEAR). You can press **C** repeatedly to erase several digits, one at a time.

To erase **all** digits simultaneously, **hold down C** until the digits disappear.

### **If a number contains more than 10 digits:**

If you enter a number with more than 10 digits, the first digits will disappear from the display.

If you wish to check these digits, press **M** (MODE) and then **RCL** (RECALL).

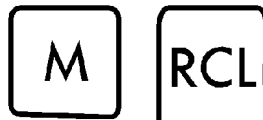

## Making a Call



The **SERV** indicator must be present in the display.

Enter the phone number, including the area code, and press **Send**.



The  symbol comes on in the display.

When you have made contact with the GSM network, a click is heard and the message “**CALL**” is displayed.

When you have been connected to the desired number, the message “**CALL**” and the number disappear from the display. Only then need you hold the phone to your ear.

### **Ending the call:**

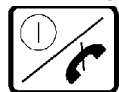

When the conversation is finished, press **End**.

**If nobody answers, or you hear an engaged or equipment-engaged tone, or you receive a message that the number is unobtainable:**

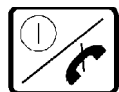

Press **End**. The phone number will be retained in memory and you can easily repeat the call. See **Last Number Recall** below.

### **If a call is unsuccessful:**

The number remains in the display and you can repeat the call by pressing just **Send**.

## **Last Number Recall**

Press **RCL** (RECALL) **twice**, or **RCL** followed by the numeric key **0**.



You can also press **0**, followed by **#** (Hash)



“**LAST DIAL**” is displayed, together with the number last called.

To make the call, press **Send**.

See also the chapter **Dialling Memory and Scratch Pad**.

## **International Calls**

International calls can be made by using the **international access** function.

Press **M** (MODE), followed by **\*** (Star).



A **minus sign** (–) is displayed on the right in the numeric field of the display. The message **“INTER NO”** appears briefly.

Enter the **Country Code**, the **Area Code** and the **Phone Number**.

When you press **Send** to make the call, the minus sign (–) will be automatically replaced by the **international prefix** of the country where the phone is presently used.

### Emergency calls

To make an emergency call, enter the GSM Emergency Number **112** and press **Send**.



The message **“EMERGENCY”** is displayed.



*Emergency calls can always be made, provided that the **SERV** indicator is ON continuously or FLASHES.*

### Receiving a Call



*The **SERV** indicator must be present in the display.*

When you are called, the phone rings. At the same time, the **■** (Call) indicator and the message **“CALL”** flash in the display.



Press **Send** to answer.

### Ending the call:



When the conversation is finished, press **End**.

### Unanswered Calls

If a call is not answered, the **■** (Call) indicator will continue to flash, indicating that somebody has called you.

The flashing **■** indicator will go out if you press any key.

### Call Time Meter

During a call the **elapsed time**, in minutes and seconds, is displayed.

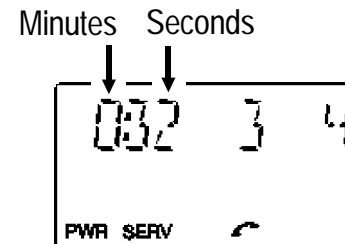

When the call is ended, the elapsed call time is displayed for an additional five seconds.

## Audible Call Timer

If Special Function No. **13. Minute Minder** is enabled, a short beep is heard in the earphone every full minute during the call. Refer to the chapter **Special Functions**.

## Volume Control



During a conversation, you can adjust the volume of the earpiece with these keys.

Press ▲ (Up) to increase and ▼ (Down) to decrease the volume. Each time you press ▲ or ▼, the volume is altered by one step, the full range being five steps.

## Microphone Mute



During a conversation, the microphone can be deactivated by holding down **M** (MUTE).

The word **“MUTED”** is shown in the display.

To resume the conversation, release the **M** key.

## Scratch Pad

During a conversation you may take a note of a phone number given to you by entering the number on the keypad. After the call is ended, the number will remain in the display and you can call it immediately. However, the number will

also be stored in the dialling memory. Refer to the chapter **Dialling Memory and Scratch Pad**.

## Key Lock

You can lock the keypad so that unintentional key action has no effect if the phone is turned on. This feature is useful when you, for example, are carrying the phone in a pocket.

The keypad remains locked until you receive a call, or until you unlock the keypad yourself.

To **lock** the keypad:

Press **M** (MODE) and then # (Hash).



**“KEYLOCK”** (Key Lock) is displayed.

To **unlock** the keypad, you do exactly the same:

Press **M**, followed by #.



**Emergency calls (112)** can be made when the keypad is locked.

## Turning the Phone Off



To turn the phone OFF, press and **hold down** the **Power** key until a click is heard.



# Details on the Display and Keys

## Display

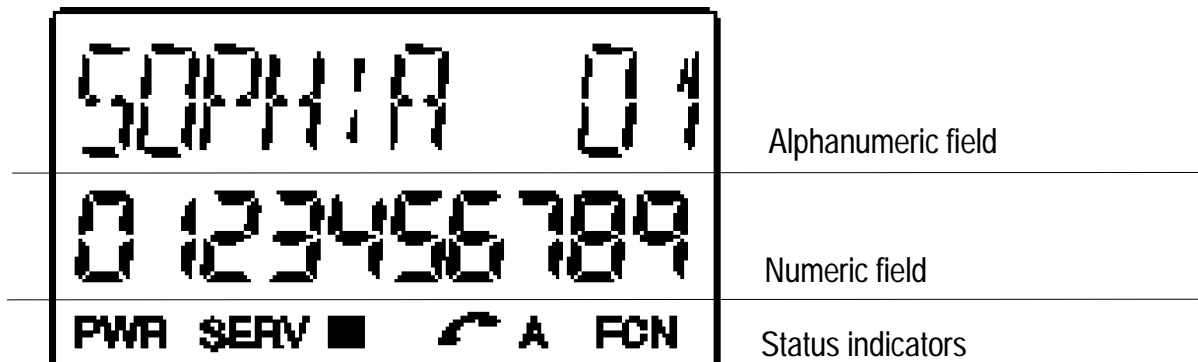

### ***Alphanumeric Field***

- Displays names and memory location numbers (as illustrated above).
- Displays messages, queries and warnings.
- Displays the strength of the received signal.
- Displays the elapsed call time while an outgoing call is in progress.
- Displays battery meter (if the phone is used as a portable unit).

### ***Numeric Field***

Displays the phone number entered on the keypad, or recalled from memory.

### ***Status Indicators***

**PWR**      **Power**  
Indicates that the phone is ON.

**SERV**      **Service**  
Indicates that service is available from a GSM network.

If **SERV** flashes, it indicates that a GSM network is in range but the phone has not registered on that network.

### **Call**

Flashes to indicate an incoming call and continues to flash if the call is not answered (Unanswered Call Indicator).

### **In Use**

The handset symbol is shown during a call and also while an outgoing call is being connected. The handset symbol flashes when the call is being released.

### **A**

#### **Alphabetic Mode**

Flashes to indicate that you can enter letters and other characters with the numeric keys **0 – 9**, and the \* and # keys. This is used to enter names when storing and recalling phone numbers.

### **FCN**

#### **Function**

Comes on after the **M** (MODE) key has been pressed momentarily.

It indicates that a second key can be pressed to perform a particular function.

# Keypad

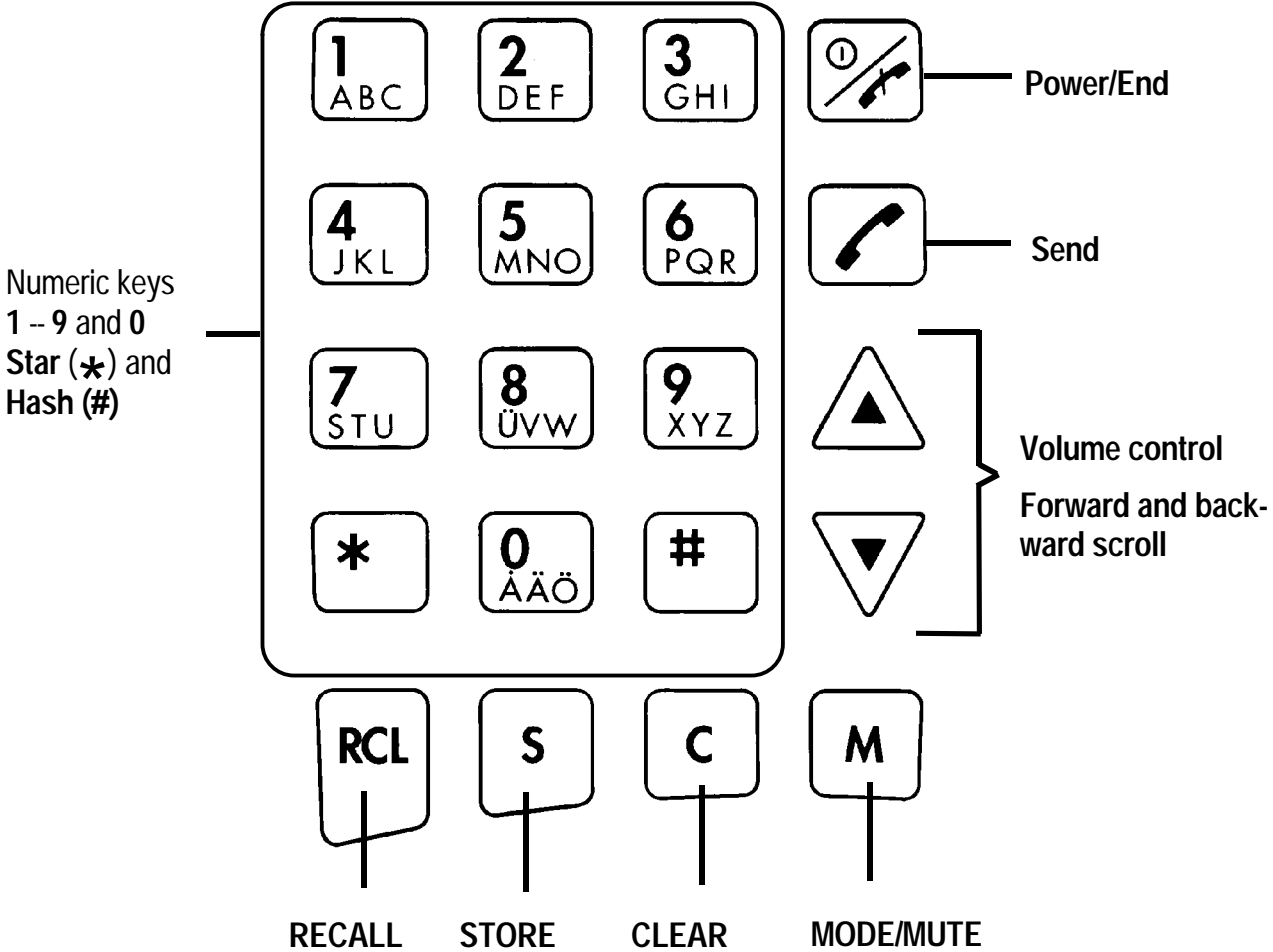



This key has **two different** functions: **Power** and **End**.



### Power

Press and **hold down** to turn the phone ON or OFF.

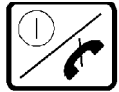

### End

To terminate a call, press momentarily.



### Send

Used to **make** a call after a number has been entered, or recalled from memory, and to **answer** an incoming call.



These keys have **two different** functions:

#### 1. Volume control

▲ (Up) increases and ▼ (Down) decreases the earpiece volume during a conversation. If the phone is used with **hands free** equipment, the loudspeaker volume will be adjusted.

#### 2. Forward and backward scroll

▲ (Up) scrolls forward and ▼ (Down) scrolls backward through the memory locations, or the names stored in memory, or through the Special Functions of the phone.



### RECALL

Used to recall a phone number from memory. Press **RCL** and then enter the number of the **memory location**. Refer to the chapter **Recalling Numbers**.



### Alphabetic mode (letter mode)

Used to recall a phone number stored under a **name**. Press **RCL**, followed by **M** (MODE). Then enter the **first letter(s)** of the name. Refer to the chapter **Recalling Numbers**.



### Last number recall

Press **RCL twice**, or **RCL** followed by **0**, to recall the number last called. Refer to the chapter **Dialling Memory and Scratch Pad**.



### Dialling memory

Press **RCL**, followed by **#**, to recall the first number in the dialling memory. Refer to the chapter **Dialling Memory and Scratch Pad**.



### STORE

Stores phone numbers (and names) in memory. Refer to the chapter **Storing Numbers**.

Stores the settings that you have selected for the Special Functions. Refer to the chapter **Special Functions**.

## CLEAR

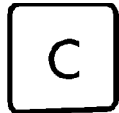

1. If pressed momentarily, it erases the last digit or letter entered. Can be pressed repeatedly to erase several characters.
2. If held down, it erases all digits, for example a phone number, from the display.
3. Exits from the Special Functions.



This key has **two different** functions: **MODE** and **MUTE**.

### 1. MODE

Press **M** momentarily. The text **"FCN"** (Function) and the **FCN** indicator come on in the display. The following functions can be obtained if a second key is pressed within 10 seconds:



Press **M**, followed by **RCL** (RECALL), to display the first digits of a phone number that includes more than 10 digits.



Press **M**, followed by **Send**, to send the digits in the display as **DTMF** signals when a call is in progress. Refer to the chapter **DTMF Signalling**.



Press **M**, followed by **\***, to use the **International Access** function. Refer to the chapter **Basic Operation**.



Press **M**, followed by **#** (Hash), to lock/unlock the keypad.



Press **M twice**, or **M** followed by **▲** (Up), to select the **first** Special Function. Further pressing **M** or **▲** (Up) repeatedly, will scroll through all the Special Functions.



To select the last Special Function, press **M** followed by **▼** (Down). Refer to the chapter **Special Functions**.

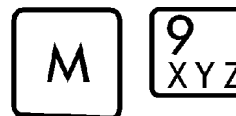

A Special Function can also be selected by pressing **M**, followed by the number (one or two digits) of the Special Function. Refer to the chapter **Special Functions**.



### 2. MUTE – Privacy key

Hold down **M** to mute the microphone during a conversation. If the phone is used with **hands free** equipment, the separate microphone will be muted.

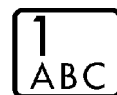

### Numeric keys

Used to enter phone numbers to be called, or stored in memory.



Used to enter memory location numbers when recalling phone numbers from the memory.



When in **alphabetic** (letter) mode, letters can be entered with the keys **0** – **9**. To enter a letter, press the appropriate key once, twice, or three times according to the position of the desired letter on the key. To enter a **digit** in Alphabetic mode, press the appropriate key four times.



### Star and Hash



Used in DTMF-signalling to enter the characters **\*** and **#**. A **\*** appears in the display as an “**H**” and a **#** as an “**o**”.

**\*** is used in **alphabetic** mode to enter a **space**. Pressing **\*** twice, enters a star.

Pressing **#** in **alphabetic** mode, enters a **hyphen** (-). Pressing **#** twice, enters a hash.

**#** stores a displayed phone number in the scratch pad. Press **S** (STORE), followed by **#**. Refer to the chapter *Dialling Memory and Scratch Pad*.

**#** can be used instead of the **RCL** key to **recall** a phone number from memory. Enter the memory location number (one or two) digits and press **#**.

Entering **0** and pressing **#**, recalls the number last called.

## Illumination

The display and keys are back lit.

If the phone is used as **portable unit**, i.e. it is powered from the attached battery, the back light is automatically turned off about ten seconds after the last key was pressed, to save the battery. However, if you are making a call, the back light will not be turned off until the call has been connected.

The back light comes on again when you press a key, or when a call is received.

You can turn the back light ON on or OFF all the time with Special Function No. **5**. Refer to the chapter *Special Functions*.

If the phone is powered from an **external source** via the receptacle at the bottom of the phone, the back light will be ON all the time until you turn the phone OFF, unless you have turned the backlight OFF yourself with Special Function No. **5**.

## Audible Signals

### Ringling Signal

The ringing signal sounds when a call is received. It will be repeated until you answer the call, or the call is terminated by the cellular network. Special Function No. **0** allows you to adjust the volume of the ringing signal. You can also turn the ringing signal OFF.

## ***Alarm Signal***

A long beep will be heard when the attached battery is becoming exhausted. The warning “**LOW BATT**” will also flash in the display.

## ***Error Signal***

A short beep tells you if you do something wrong. For example, if you try to store a phone number in a memory location that is already in use.

The error signal also sounds if an attempted call is unsuccessful or a call in progress is interrupted.

## ***Confirmation Click***

When you hold down the **Power** key, a click tells you when the phone is actually turned on or off.

When you are making a call, a click is heard when you have made contact with network.

## **Visual Signals**

There is an indicator light on the top edge of the phone. Its location is shown in the figure on page 2.

### ***Slow green flashing – Service is available***

If the phone is used as a **portable unit**, slow green flashing has the same significance as the **SERV** indicator in the display. You can both make and receive calls.

If the phone is powered from an **external source** via the receptacle at the bottom of the phone, a **steady green light** is shown instead of the slow green flashing.

### ***Rapid green flashing – Incoming call***

Rapid green flashing has the same significance as the  (Call) indicator in the display. It indicates that someone is calling or has called you (Unanswered Call Indicator).

### ***Red flashing – Low battery alarm***

Red flashing indicates that the attached battery is becoming exhausted. The red flashing starts when the low battery alarm is issued for the first time.

### ***Steady red light***

Finally, after the low battery alarm has been issued several times, the phone turns itself off and a **steady red light** comes on. Refer to the chapter ***Batteries and Recharging***.

# Storing Numbers

You can store often-used phone numbers in the memory of your SIM, both when the phone is in standby mode and during a conversation.

The actual number of memory locations available depends on the programming of your SIM.

A phone number to be stored may contain up to **20** digits.

A phone number can be stored in a memory location with, or without, an accompanying **name**.

The number of letters in a name is SIM-dependent. However, the maximum number of letters that are handled by the phone is **eight**, including spaces.



*The numbers stored in memory locations **1 -- 9** can be called directly by entering the number of the memory location and pressing **Send**. See the section **Speed Calling** in the next chapter, **Recalling Numbers**. Keep this in mind and spare memory locations **1 -- 9** for important numbers.*



*It is sometimes useful to store just the initial part of a number, or the initial part of several numbers, a **partial number**, for example an area code. Later, when you recall a partial number, you can append the remaining digits, using the numeric keys.*

## Storing a Number (and Name)

1. Enter the phone number you wish to store, including the area code.
2. Press **S** (STORE). The word “**STORE**” is displayed.
3. To store the number in the **first free** memory location, go to step **5**, below.
4. To store the number in a **different** memory location, enter the number of this memory location (one or two digits).
5. Press **S** again. The question “**NAME?**” appears and the **A** (Alphabetic mode) indicator flashes in the display. This indicates that you can now enter an accompanying name if you wish to do so.
6. Enter the first letter of the name by pressing the appropriate numeric key once, twice or three times, depending on the position of the letter on the key. For example, pressing the **1** key **twice** enters a **B**.



When an **underline** character (    ) appears to the right of the letter entered, you can enter the next. You can enter up to **eight** letters.

- If you want to enter a **digit** (0 – 9) instead of a letter, press the appropriate numeric key four times.
- If you want a **space**, press the **★** (Star) key once. Pressing **★** twice, enters a star.
- If you want a **hyphen** (-), press the **#** (Hash) key once. Pressing **#** twice, enters a hash.
- If you make a mistake, correct it with the **C** key.

7. When you have entered the entire name, press **S**. “**STORED**” is displayed. The number and name is stored. The display returns to normal.

If you do **not** press **S**, the number and name will be stored automatically after about 20 seconds.

If you change your mind and do **not** wish to store the number and name, press and hold down **C** within these 20 seconds.

 *If you do not wish to enter a name, press **S** when the question “**NAME?**” appears. The number will then be stored without a name.*

## **Memory Protection**

If you try to store a number in a memory location which already contains a number, the message “**USED**” flashes in the display for five seconds.

You can then choose either to:

- a. Store the number in a different memory location. Enter the number of this memory location and press **S**.
- b. Store the number under the selected memory location, thus **erasing** the old number (and name). Just press **S**.

## **Memory Full**

If, when you attempt to store a new number, all memory locations are in use, “**STORE LOC?**” is displayed.

If you do **not** wish to store the number, press **C**.

If, on the other hand, you do wish to store the number, you can do one of the following:

- a. Store the number **temporarily** in the dialling memory. Press **#** (Hash). “**STORED DM**” is displayed. See also the chapter **Dialling Memory**.
- b. Store the number in an already occupied memory location, thus erasing the old number (and name). Enter the required memory location number and press **S**.

## Erasing a Stored Number (and Name)

A previously stored phone number (and name) will be erased automatically if you store a new number in the same memory location.

However, you can erase a number **without** replacing it with a new number, by proceeding as follows:

1. If there is anything showing in the numeric field of the display, erase it with the **C** key.
2. Press **S**. “**ERASE**” is displayed.
- 3a. Enter the memory location number (one or two digits) and go to step 4, **or**
- 3b. Press **S**. “**NAME?**” is displayed. Enter the name stored with the phone number.
4. Press **S** again. “**ERASED**” is displayed. The number (and name) is erased.

# Recalling Numbers

## Numeric and Alphabetic Mode

If you wish to recall a stored phone number, press the **RCL** (RECALL) key.

**Numeric mode** applies automatically after you have pressed the **RCL** key. It means that you can recall the number by entering the **number** of the **memory location**.

If you wish to recall the number by using the **name**, or the first part of the name, you have to select **alphabetic mode** by pressing **M** (MODE) after **RCL**. The **A** indicator will flash in the display.



*If you select alphabetic mode by mistake, press **M** again. You can then enter a memory location number instead.*

## Recalling a Number Using Numeric Mode

1. Press **RCL**. “**RCL**” is displayed.
2. Enter the memory location number (one or more digits). The (name and) phone number appears in the display.
3. To call the number, press **Send**.

## *Scrolling through the Memory*

You can display the contents of each memory location by scrolling through the memory.

1. Press **RCL**. “**RCL**” is displayed.
2. To **scroll forward** from memory location 1, press **▲** (Up) repeatedly. If you scroll too far, you can move back by pressing **▼** (Down).

To **scroll backward** from the highest memory location, press **▼** repeatedly. If you scroll too far, you can move forward by pressing **▲**.



*You can enter a memory location number (one or two digits), before pressing **▲** or **▼**, to begin scrolling with this number.*

3. To call the number displayed, press **Send**.

## *Alternative Method for Recalling a Number*

1. Enter the memory location number (one or more digits).
2. Press **#** (Hash). The (name and) phone number appears in the display.
3. To call the number, press **Send**.

## Speed Calling

The numbers stored in memory locations **1 - 9** can be called by just entering the memory location number and pressing **Send**. The number appears in the display. If the number was stored with an accompanying name, the name will be displayed briefly.

If you called a wrong number, you can press **End** before the call has been connected.

## Recalling a Number Using Alphabetic Mode

1. Press **RCL**. “**RCL**” is displayed.
2. Press **M** to select **alphabetic mode**. The **A** indicator flashes.
3. Enter the **first** letter of the name by pressing the relevant numeric key once, twice or three times, depending on the position of the desired letter and press **RCL** or **▲**.



*If you wish, you can enter up to six letters before pressing **RCL** or **▲**.*

*For example, to recall the number stored under the name ANTHONY, you can enter A, AN, ANT, ANTH, ANTHO or ANTHON.*

The first name that begins with the letter(s) entered, is displayed, together with the phone number.

4. If the desired name is not displayed, scroll forward by pressing **▲** until you find it. If you scroll past the name you can move back by pressing **▼**.
5. To call the number displayed, press **Send**.

## Scrolling through the Memory

1. Press **RCL**. “**RCL**” is displayed.
2. Press **M** to select **alphabetic mode**. The **A** indicator flashes.
3. Press **▲** repeatedly to scroll forward through the names, or press **▼** repeatedly to scroll backward through the names.



*You can enter a letter before pressing **▲** or **▼**, to begin scrolling with this letter.*

4. To call the number displayed, press **Send**.

## Reviewing the First Digits if a Recalled Number Contains More than 10 Digits

If you recall a phone number which contains more than 10 digits, the first digits will be displayed first, followed after a few seconds by the remaining 10 digits.



*If you wish to check the first digits, press **M** and then **RCL**.*

## Appending Digits to a Recalled Number

If you have stored a **partial number**, you can recall it from the memory and then append the remaining digits, using the numeric keys.

## Replacing the Last Digits of a Recalled Number

A number recalled from the memory can be altered by erasing the last digits using the **C** key, and then entering new digits.

# Dialling Memory and Scratch Pad

## Dialling Memory

The dialling memory has six memory locations (0 and 1 – 5).

The **last number called** is stored in memory location 0 of the dialling memory. As described in the chapter **Basic Operation**, you can **recall** this number by:

- a. pressing **RCL twice**, or
- b. pressing **RCL**, followed by **0**, or
- c. pressing **0**, followed by **#** (Hash).

If another call is made, the last number called is transferred to location 1 of the dialling memory.

Previously stored numbers are moved one location forward in the dialling memory. If all memory locations are used, the number that was stored in location 5, will be dropped.

A phone number cannot be stored twice in the dialling memory. If a number which is already present in the dialling memory is entered, the “old” number will be removed.



*The numbers in the dialling memory will not be retained after the phone has been turned off.*

## *Recalling the Last Six Numbers Called*

Numbers stored in the dialling memory can be recalled in two ways.

- a. Press **RCL twice**, or **RCL** followed by **0**. “**LAST DIAL**” is displayed together with the number last called.
- b. Press **RCL**, followed by **#** (Hash). “**MEMORY 1**” is displayed, together with the number stored in memory location 1 of the dialling memory.

You can then scroll forward or backward through the memory locations of the dialling memory by pressing ▲ or ▼ until you find the desired number.

## Scratch Pad

### *Storing a Number*

Besides the phone numbers that are stored automatically each time a call is made, you can yourself store phone numbers in the dialling memory.

- a. You may take a note of a phone number given to you during a call, by entering the phone number on the keypad. When you end the call by pressing **End**, the number is automatically stored in memory

location 1 of the dialling memory. The number remains, however, in the display.

**b.**

Independent of whether a call is in progress or not, you can enter a phone number and store it by pressing **S**, followed by # (Hash). **“STORED DM”** is displayed. The number is stored in memory location 1.

### ***Recalling a Number***

1. Press **RCL**, followed by # (Hash). **“MEMORY 1”** is displayed, together with the number stored in memory location 1 of the dialling memory.
2. If necessary, scroll forward through the memory locations of the dialling memory by pressing ▲ until you find the desired number.

# DTMF Signalling

## Sending DTMF Signals

You can use keys **0 – 9**, **\*** and **#** to send DTMF (Dual Tone Multi Frequency) signals to access special services, for example “banking by phone”.



*DTMF signals cannot be sent unless the “**DTMF**” option in Special Function No 1. **Key Clicks, Silent Keypad or DTMF Signals** is enabled.*

*If required, select the “**DTMF**” option. This can be done both when the phone is in standby mode and when a call is in progress. Refer to the chapter **Special Functions**.*

1. Call the desired number.
2. When the call has been connected, pressing keys **0 – 9**, **\*** and **#** will cause the corresponding DTMF signals to be sent.

The characters entered remain in the display. To avoid that the characters are stored in the scratch pad, erase them using the **C** (CLEAR) key before ending the call.

## Sending a Code

If you need to send a code (a sequence of digits), for example your personal access code, it could sometimes be advantageous to use the following method.



*A code cannot be sent unless the “**DTMF**” option in Special Function No. 1 is **disabled**.*

*If required, select the “**CLICK ON**” or “**SILENT**” option. This can be done both when the phone is in standby mode and when a call is in progress. Refer to the chapter **Special Functions**.*

1. Call the desired number.
2. When the call has been connected, enter the code you wish to send. The code can be any combination of the digits **0 – 9**, and the characters **\*** and **#**.

If you make a mistake, while entering the code, you can correct it with the **C** (CLEAR) key.

You may enter a maximum of **36** characters. However, if you enter **digits only**, a maximum of **20** can be entered.



3. To send the code, press **M** (MODE), followed by **Send**.

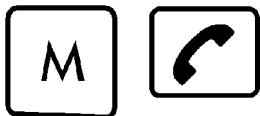

The sequence of characters is converted to DTMF signals and sent automatically, one character at a time. The characters disappear from the display, when the transmission starts.

## Pre-programmed DTMF Signalling

You can store a code in memory in the same way as you store a phone number.

The code can be any combination of the digits **0** -- **9** and the characters **\*** and **#**, and it may contain up to **20** characters.

### **To send the code:**

1. Call the desired phone number and wait until the call has been connected.
2. Recall the code from memory. The characters appear in the display.
3. To send the code, press **M**, followed by **Send**. The sequence of characters is converted to DTMF signals and sent automatically, one character at a time. It is irrelevant whether the **“DTMF”** option is selected or not.



*If the **“DTMF”** option is enabled, you must use the **RCL** key to recall the code. **Do not** use the **#** key.*

# Special Functions

The Special Functions are arranged in the following order:

No.	Text in the display	Special Function
0	RING LEVEL	Ringing signal volume.
1	CLICK ON” “SILENT” “DTMF ON	Key clicks, silent keypad or DTMF signals.
2	FORWARD	Call forwarding.
3	<b>BARRING</b>	Call barring.
4	<b>“RETRY OFF”</b> “RETRY ON”	Automatic re-try.
5	LIGHT AUTO” LIGHT OFF” LIGHT ON”	Back light.
6	Name of current Network	Current network.
7	AVAIL NETW	Available networks.
8	AUT SEARCH” MAN SEARCH	Network selection mode.

No.	Text in the display	Special Function
9	NETWSEARCH	Automatic network selection.
10	PREF NETW	List of “preferred” networks.
11	LAST XXXX”	Last call time.
12	TOTAL XXXX”	Total call time.
13	M MNDR OFF” M MNDR ON	Minute minder.
14	PIN	PIN.
15	ANYKEY OFF” ANYKEY ON	Answering an incoming call by pressing any key.
16	ENGLISH” <i>2nd language”</i> 3rd language”, etc	Language selection.
17	AREA OFF” AREA CODE	Area code.
18	“DISCHRG OF”	Battery discharge.

No.	Text in the display	Special Function
19	VOLT XX"	Battery voltage.
20	PHONE LOCK	Phone lock.

Some of the Special Functions are **optional** and will not be available unless you have ordered them.

Some of the special functions will be available only when the **SERV** (Service) indicator is present in the display, others will not be available when a call is in progress.

## Accessing a Special Function

There are **two** methods for accessing a particular Special Function.

### Using Method 1



Press **M** (MODE). The message "**MODE**" comes on in the display, together with the **FCN** (Function) indicator.

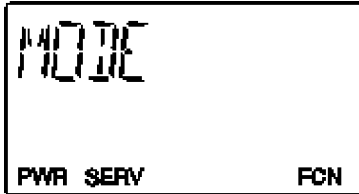

Enter the **number** of the Special Function (one or two digits) within 10 seconds. For example, entering **11**, takes you to the **Last Call Time** function.

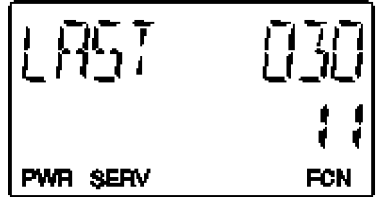

*If you try to access a Special Function that is inaccessible, the message "**NOT AVAIL**" will be displayed.*

### Using Method 2



Select the **first** Special Function, **Ring-ing Signal Volume**, by pressing **M** (MODE), followed by **▲** (Up). You can also press **M twice**.



To select another Special Function, scroll forward by pressing **▲** (or **M**) repeatedly. Special Functions that are inaccessible, will be passed over.

If you scroll too far, you can go back by using ▼ (Down).



To select the **last** Special Function, press **M** and then ▼. You can then select another Special Function, by scrolling backward with ▼.

### Using a Combination of the Two Methods

Enter the number of a Special Function, for example **11**, and then scroll forward or backward using ▲ or ▼.

### Leaving a Special Function



A Special Function is left automatically after 10 seconds, and the display returns to normal. Within these 10 seconds you can press ▲ or ▼ to move on to another Special Function, or **C** (CLEAR) to leave the Special Functions.

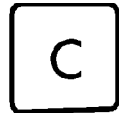

*A Special Function will be left automatically if somebody calls you. Press **Send** to answer.*

### Changing a Setting

You can change the setting of certain Special Functions. For example, with Special Function No. **0. Ringing Signal**

**Volume**, you can set the volume of the ringing signal in four steps, or turn the ringing signal OFF.

To change the setting, proceed as follows:



Press **any** numeric key, or the \* (Star) or # (Hash) key (repeatedly) until the desired setting appears in the display.

The **Ringing Signal Volume** function has five settings. If you press a numeric key a fifth time, the initial setting reappears.

### Storing a New Setting



Pressing **S** (STORE), ▲ or ▼ will store the new setting.

Press **S** if you wish to store the setting and then **leave** the Special Functions.



Press ▲ (Up) or ▼ (Down) if you wish to store the setting and then **go on** to another Special Function.



Press ▲ once again to move on to the next Special Function, or ▼ to move back to the preceding Special Function.



*If you do not press **S**, ▲ or ▼ within 10 seconds, you will leave the Special Functions automatically. The new setting will, however, **not** be stored.*



*If you wish to leave the Special Functions **without** storing anything, press **C** (CLEAR) within these 10 seconds.*

## 0. Ringing Signal Volume

You can set the level of the ringing signal in four steps, or turn the ringing signal OFF.

1. Press **M**, followed by **0**.  
“**RING LEVEL**” is displayed, together with the current setting, either:  
#— (lowest level)  
##—  
###-  
#### (highest level)  
—— (turned OFF)
2. Press any numeric key (repeatedly) to set the ringing signal level, or turn the ringing signal OFF. Each of the four levels is accompanied by an audible ringing signal.
3. Store the new setting by pressing **S**, ▲ or ▼.

## 1. Key Clicks, Silent Keypad or DTMF Signals

You can decide that DTMF signals will be sent if the numeric keys **0 – 9**, **\*** and **#** are pressed when a call is in progress. See also the chapter **DTMF Signalling** earlier in this manual.

On the other hand, if you **do not** wish DTMF signals to be sent, you can decide whether key clicks or nothing at all will be heard when you press the keys (silent keypad).

1. Press **M**, followed by **1**. The current setting is displayed, either:  
“**CLICK ON**” or  
“**SILENT**” or  
“**DTMF ON**”
2. Select the desired setting by pressing any numeric key (repeatedly).
3. Store the new setting by pressing **S**, ▲ or ▼.



*If you select the **Silent Keypad** setting, the error signal will be turned off, too.*

## 2. Call Forwarding

*This facility is not available unless you have subscribed to it. You should also read the operating instructions from your network operator.*

You can decide that incoming calls will be forwarded (diverted) to another number:

- if you are **busy** (engaged in a call).
- if you do **not answer**.
- if your phone is **unreachable** ( or turned off).

You can also forward **all calls**.

This Special Function lets you **activate** or **cancel** one or more of the above services. You can also **review** whether a particular service is activated or not.

## **Activating, cancelling or reviewing the status of a call forwarding service:**

1. Press **M**, followed by **2**.  
“**FORWARD**” is displayed.
2. Press **S**. “**ALL CALLS**” appears in the display.  
To select another call forwarding service, scroll forward or backward using ▲ and ▼. (You can also scroll forward using any numeric key.)  
“**IF BUSY**”  
“**NO REPLY**”  
“**UNREACHABL**”  
appear in the display.  
The message “**CANCEL ALL**” will also appear when you are scrolling. The **Cancel All** service is, however, described later in this section.
3. When the desired call forwarding service, for example “**IF BUSY**”, is displayed, press **S**.  
“**ACTIVATE**” appears in the display.  
To **cancel** the service selected, or **reviewing its status** (ON or OFF), scroll with ▲ or ▼.  
“**CANCEL**”  
“**STATUS**”  
appear in the display.
4. When the desired option, for example “**STATUS**”, is displayed, press **S**.

5a. If you chose to **cancel** or **review the status** of a call forwarding service, go to step 6.

5b. If you chose to **activate** a call forwarding service, the question “**NUMBER?**” appears.

Enter the phone number (including the area code) to which calls are to be forwarded and press **S**.



You may **recall** the number from memory. You must use the **RCL** key to recall the number. **Do not** use the alternative method with the **#** key. When the desired number is displayed, press **S** twice.

6. The message “**WAIT**” appears briefly.

When you have made contact with the GSM network, either

“**FORWARD ON**”, together with the number to which calls will be forwarded, or

“**FORWRD OFF**”

comes on for ten seconds in the display.

## **Cancelling ALL call forwarding services:**

If one or more call forwarding services are activated, you can cancel them all by using the **Cancel All** service.

1. Press **M**, followed by **2**.  
“**FORWARD**” appears.
2. Press **S**. “**ALL CALLS**” appears.
3. Scroll using ▲ or ▼ until  
“**CANCEL ALL**” appears.
4. Press **S**. The message “**WAIT**” is displayed briefly.

When you have made contact with the GSM network, the message **“FORWRD OFF”** is displayed for ten seconds.

***If the connection fails:***

If the connection with the GSM network fails, a beep is heard and the message **“NETWORK PROBLEM”** – – – **“NETW PROBL”** appears.

Wait a moment and try again.

### **3. Call Barring**

*This facility is not available unless you have subscribed to it. You should also read the operating instructions from your network operator.*

You can bar outgoing and incoming calls, to restrict the use of your phone. The following call barring services are available:

- Barring **all outgoing** calls. **Emergency calls (112)** can, however, be made.
- Barring **outgoing international** calls.
- Barring **outgoing international** calls **except** to your **home country**.
- Barring **all incoming** calls.
- Barring **incoming** calls **when roaming**.

This Special Function lets you **activate** or **cancel** one or more of the above services. You can also **review** whether a particular service is activated or not.

To prevent unauthorized use of a call barring service, a **password** must be entered each time such a service is activated or cancelled. To improve security, you should **change the password** given to you by the GSM operator. The Call Barring Special Function, therefore, lets you change the password.

***Activating, cancelling or reviewing the status of a call barring service:***

1. Press **M**, followed by **3**.  
**“BARRING”** is displayed.
2. Press **S**. The message **“ALL OUTGOING CALLS”** appears, followed by the abbreviation **“ALL OUT”**.  
To select another call barring service scroll forward or backward using **▲** and **▼**. (You can also scroll forward using any numeric key.)

**“OUTGOING INTERNATIONAL CALLS”** – – –  
**“O INT”**

**“OUT INTL EXCEPT TO HOME COUNTRY”** – – –  
**O INT XH”**

**ALL INCOMING CALLS”**  
– – – **“ALL INC”**

**“INCOMING CALLS WHEN ROAMING”** – – –  
**“INC ROAM”**

appear in the display.

The messages:

**“CANCEL ALL”** and  
**“CHANGE PASSWORD”**  
— — — **“CHG PASSW”**

will also appear when you are scrolling. The **Cancel All** and **Change Password** services are, however, described later in this section.

3. When the desired service, for example **“ALL INC”** (all incoming calls), is displayed, press **S**.

**“ACTIVATE”** appears.

To **cancel** the service selected, or **reviewing its status** (ON or OFF), scroll with ▲ or ▼.

**“CANCEL”**  
**“STATUS”**

appear in the display.

4. When the desired option, for example **“STATUS”** is displayed, press **S**.

- 5a. If you chose to **review the status** of a call barring service, go to step 6.

- 5b. If you chose to **activate** or **cancel** a call barring service, the question **“PASSWORD?”** appears.

Enter your **password** and press **S**.

6. The message **“WAIT”** is displayed briefly.

When you have made contact with the GSM network, either

**“BARRING ON”** or  
**“BARRING OF”**

comes on for ten seconds in the display.

If you entered the wrong password, the message **“PASSWORD ERROR”**

— — — **“PASSW ERR”**

is displayed.

### ***Canceling ALL call barring services:***

If one or more call barring services are activated, you can cancel them all by using the **Cancel All** service.

1. Press **M**, followed by **3**.  
**“BARRING”** appears.
2. Press **S**. **“ALL OUTGOING CALLS”** appears, followed by the abbreviation **“ALL OUT”**.
3. Scroll using ▲ or ▼ until **“CANCEL ALL”** appears.
4. Press **S**. The question **“PASSWORD?”** appears.
5. Enter your **password** and press **S**.
6. The message **“WAIT”** is displayed briefly.

When you have made contact with the GSM network, **“BARRING OF”** comes on for ten seconds in the display.

If you entered the wrong password, the message **“PASSWORD ERROR”** — — — **“PASSW ERR”** is displayed.



### Changing your password:

1. Press **M**, followed by **3**.  
“**BARRING**” appears.
2. Press **S**. “**ALL OUTGOING CALLS**” appears, followed by the abbreviation “**ALL OUT**”.
3. Scroll using ▲ or ▼ until  
“**CHANGE PASSWORD**” --- “**CHG PASSW**” is displayed.
4. Press **S**. “**OLD?**” is displayed.
5. Enter the **present** password and press **S**. “**NEW?**” is displayed.
6. Enter the **new** password and press **S**. “**AGAIN?**” is displayed.
7. Enter the **new** password again and press **S**.  
“**WAIT**” is displayed briefly.

If you entered the old code and the new code correctly

“**PASSWORD CHANGED**” --- “**PASSW CHGD**” comes on for ten seconds in the display when you have made contact with the GSM network.

If you entered the old code incorrectly the message “**PASSWORD ERROR**” --- “**PASSW ERR**” is displayed.

If you entered the new code incorrectly, you are asked to enter both codes again.



*There is an alternative method for changing your password. Refer to the chapter **Problems You Can Solve**.*

### If the connection fails:

If the connection with the GSM network fails, a beep is heard and the message “**NETWORK PROBLEM**” --- “**NETW PROBL**” appears.

Wait a moment and try again.

## 4. Automatic Re-try

This Special Function will automatically re-dial a number when an outgoing call has failed because the called number or the GSM network is busy.

The re-dial will be repeated until the call is answered or ten times at the most. In the meantime, the message “**RETRY**” is displayed, replacing the abbreviation for the network. The battery meter is replaced by “**AR**”.



*Pressing **any** key will interrupt the automatic re-try function. To interrupt the re-try function when a re-dial is in progress, the **End** key must be pressed.*

The automatic re-try function is enabled/disabled as follows:

1. Press **M**, followed by **4**. The current setting, either “**RETRY OFF**” or “**RETRY ON**”, is displayed.
2. Turn the automatic re-try ON or OFF by pressing any numeric key.
3. Store the new setting by pressing **S**, ▲ or ▼.

## 5. Back Light

The illumination of the display and keypad can be turned ON or OFF all the time, or it can be used in an automatic mode as described in the section *Illumination* in the chapter *Details on the Display and Keys*.

This special function allows you to turn the illumination ON or OFF, or to select the automatic mode.

1. Press **M**, followed by **5**. The current setting is displayed, either **“LIGHT AUTO”** or **“LIGHT OFF”** or **“LIGHT ON”**.
2. Turn the illumination OFF or ON, or select the automatic mode of illumination by pressing any numeric key.
3. Store the new setting by pressing **S**, **▲** or **▼**.

When the phone is **powered from an external source** via the receptacle at the bottom of the phone, the illumination will be ON all the time, regardless of whether **“LIGHT AUTO”** or **“LIGHT ON”** is selected.

## 6. Current Network

This Special Function displays the name of the network the phone is operating on.

1. Press **M**, followed by **6**. The name of the current network appears for 10 seconds.

If the phone has not registered on a network, **“NO NETWORK”** is displayed.

2. Press **C** to leave the Special Functions, or **▲** or **▼** to move on to another Special Function.

## 7. Available Networks

This Special Function allows you to select a network from those in range.

1. Press **M**, followed by **7**. **“AVAIL NETW”** is displayed.
2. Press any numeric key or **S**. **“WAIT”** is displayed briefly.
  - a. If the “home” network is in range, its name will be displayed, followed by **“CURRENT”** if it is the current network, or **“HOME”** if the phone operates on another network.
  - b. If the “home” network is **not** in range, the name of another network in range will be displayed, followed by either **“CURRENT”**, **“PREFERRED”**, **“FORBIDDEN”** or **“AVAILABLE”**.

**“Preferred”** means that a network is included in the list of “preferred” networks on your SIM. (This list can be changed with Special Function No. 10.)

“**Forbidden**” means that a network is included in the list of forbidden networks on your SIM.

“**Available**” means a network **other** than the “home” network, the current network, a “preferred” network or a “forbidden” network.

- c. If no network is in range, “**NO NETWORK**” is displayed.

- 3. If more than one network is in range, the name of the network(s) may be displayed one by one by pressing any numeric key repeatedly. The name of a network is followed by either “**CURRENT**”, “**PREFERRED**”, “**FORBIDDEN**” or “**AVAILABLE**”.

- 4. When the network you wish to use is displayed, press **S**.

If you change your mind and do not want to select another network, press **C**.



*The name of a network and the word “**CURRENT**”, “**HOME**”, “**PREFERRED**”, “**FORBIDDEN**” or “**AVAILABLE**” is displayed first, followed by an abbreviation for the name of the network and “**CURR**”, “**HOME**”, “**PREF**”, “**FORB**” or “**AV**” respectively.*

## 8. Network Selection Mode

The phone can select a network automatically from those in range. The order of preference in which the phone will select is defined in a list of “preferred” networks on your SIM. Refer to Special Function No. **10**.

You can also select a network yourself (manual selection).

This Special Function allows you to choose automatic or manual selection mode.

- 1. Press **M**, followed by **8**. Either “**AUT SEARCH**” or “**MAN SEARCH**” is displayed.
- 2. Press any numeric key to change the selection mode.
- 3. Store the new setting by pressing **S**, **▲** or **▼**.

## 9. Automatic Network Selection

You can request an automatic selection of networks at any time with this Special Function.

- 1. Press **M**, followed by **9**. “**NETWSEARCH**” is displayed.
- 2. Press **S** to start the automatic selection of networks.  
If you do not want to start the network selection, press **C** to leave the Special Functions, or **▲** or **▼** to move on to another Special Function.



*To interrupt the network selection, when in progress, and return to the previous network, press **C**.*

## 10. List of “Preferred” Networks

A list of “preferred” networks on your SIM defines the order of preference in which the phone will select a network during automatic network selection,

This Special Function allows you to review the list of networks. You can also **insert** networks, or **delete** networks from the list, or **re-arrange** the order of the networks.

The number of networks that can be included in the list depends on the programming of the SIM.

### *Reviewing the list of networks:*

1. Press **M** and then enter **10**. “**PREF NETW**” is displayed.

2. Press any numeric key or **S** to display the first “preferred” network.

The alphanumeric field of the display shows the abbreviation for the network, followed by its preference number, **NO 1**.

The numeric field shows the 3-digit country code and the 2-digit network code.

3. Press any numeric key repeatedly to display the other networks.

If the list is not full, a preference number without any network data will be displayed as the last item, to indicate that another network can be inserted.

If you wish to leave the Preferred Networks function without changing anything, press **C**. Otherwise, go on to the section

*Inserting a network, Deleting a network or Rearranging the order of networks* below.

### *Inserting a network:*

3. Press any numeric key repeatedly until the desired preference number for the network is displayed, for example “**NO 3**”.

4. Press **S**. “**ENTER NETW**” is displayed.

5. Enter the 3-digit country code, followed by the 2-digit network code.

6. Press **S** to add the network to the list.

If you change your mind and do not wish to insert the network, press **C**.



*If you choose a preference number which already contains a network, for example “**NO 3**”, that network will be given preference number “**NO 4**”. If the list of networks becomes full, the last network is deleted from the list.*

### *Deleting a network:*

3. Press any numeric key repeatedly until the network you wish to delete is displayed.

4. Press **▼** repeatedly until preference number “**NO 0**” is displayed. Both the abbreviation for the network and “**NO 0**” flash in the display.

5. Press **S** to delete the network. The display returns to normal.

If you change your mind and do not wish to delete the network, press **C**.

### ***Rearranging the order of networks:***

3. Press any numeric key repeatedly until the network you wish to move within the list is displayed.
4. Move the network to a **higher** preference number by pressing **▲** or to a **lower** preference number by pressing **▼**.
5. Press **S** to store the new preference number. The display returns to normal.

If you change your mind and do not wish to alter the preference number of the network, press **C**.

## **11. Last Call Time**

This Special Function allows you to read off the elapsed time of the last outgoing call.

1. Press **M** and then enter **11**. **“LAST”** is displayed, followed by the elapsed time (in minutes and seconds) of the last outgoing call.
2. Press **C** to leave the Special Functions, or **▲** or **▼** to move on to another Special Function.

## **12. Total Call Time**

This Special Function allows you both to read off the total elapsed call time and to reset the call time meter.

### ***To read off the call time meter:***

1. Press **M**, followed by **12**. **“TOTAL”** is displayed, followed by the total elapsed call time (in full minutes) since the call time meter was last reset.
- 2a. Press **C** to leave the Special Functions **▲** or **▼** to move on to another Special Function.

### ***To reset the call time meter:***

The total elapsed time is displayed for 10 seconds.

- 2b. Press any numeric key within these 10 seconds. **“RESET”** is displayed.
3. Press **S**, **▲** or **▼** to reset the call time, or press **C** to retain the meter reading.

## **13. Minute Minder**

This Special Function gives an indication of the time spent during conversation by emitting a short beep every full minute.

1. Press **M** and then enter **13**. The current setting, either **“M MNR OFF”** or **“M MNR ON”**, is displayed.
2. Turn the minute minder ON or OFF by pressing any numeric key.
3. Store the new setting by pressing **S**, **▲** or **▼**.

## 14. PIN

Your SIM is protected by a 4- to 8-digit PIN (Personal Identification Number).

This Special Function allows you to decide whether or not the PIN must be entered on the keypad each time the phone has been turned on (PIN Check).

The function also allows you to

- change the PIN.
- enter a new PIN, in case you have forgotten the existing one. In this case you must use your personal 8-digit **SIM Unblocking Key**.

### **Enabling/Disabling the PIN Check:**

1. Press **M** and then enter **14**.  
“**PIN**” is displayed.
2. Press any numeric key. Either “**LOCK?**” (PIN check is disabled) or “**UNLOCK?**” (PIN check is enabled) is displayed.
3. To enable or disable the PIN check, press **S**.  
“**PIN?**” is displayed.
4. Enter your PIN (4 to 8 digits) and press **S**.

If you entered the PIN correctly, “**UNLOCKED**” or “**LOCKED**” is displayed briefly.

If you entered the PIN incorrectly, a beep is heard and “**WRONG PIN**” is displayed briefly. The display then returns to normal.



*If the SIM card does not allow the PIN check to be disabled, the question “**UNLOCK?**” will not be displayed*

### **Changing your PIN:**



*The PIN check must be enabled. Otherwise, you cannot change your PIN.*

1. Press **M** and then enter **14**. “**PIN**” is displayed.
2. Press any numeric key **twice** “**CHANGE PIN**” is displayed.
3. Press **S**. “**OLD?**” is displayed.
4. Enter the present PIN and press **S**. “**NEW?**” is displayed.
5. Enter the new PIN and press **S**. “**AGAIN?**” is displayed.
6. Enter the new PIN again and press **S**.

If you entered the old PIN correctly, and the new PIN is accepted by the SIM module, “**NEW PIN**” is displayed briefly.

### **Unblocking Procedure:**

1. Press **M** and then enter **14**. “**PIN**” is displayed.
2. Press any numeric key repeatedly until “**UNBLOCK**” is displayed.
3. Press **S**. “**CODE?**” is displayed.
4. Enter the **SIM Unblocking Code** and press **S**.  
“**NEW PIN?**” is displayed.

5. Enter the new PIN and press **S**. “**AGAIN?**” is displayed.
6. Enter the new PIN again and press **S**. If you entered the SIM Unblocking Code and the new PIN correctly, “**UNLOCKED**” is displayed briefly. You can now use your phone anew.

If the message “**SIM BLOCKD**” is displayed, it indicates that the SIM is blocked.



*If the message “**SIM UNUSE**” is displayed, the SIM cannot be unblocked. Contact your network operator.*

## 15. Any Key

*This function will only be available if the phone is used with hands-free equipment.*

This Special Function allows you to answer a call by pressing **any** key, except the **Power** key.

1. Press **M** and then enter **15**. The current setting, either “**ANYKEY OFF**” or “**ANYKEY ON**”, is displayed.
2. Turn the **Any Key** function ON or OFF by pressing any numeric key.
3. Store the new setting by pressing **S**, ▲ or ▼.

## 16. Language Selection

This Special Function allows you to select a language other than English to be shown in the display.

1. Press **M** and then enter **16**. The current language, for example “**ENGLISH**”, is displayed.
2. Press any numeric key (repeatedly) until the desired language, for example “**DEUTSCH**”, is displayed.
3. Store the new setting by pressing **S**, ▲ or ▼.  
From now on, all messages appearing in the display will be in the language you selected.

## 17. Area Code

This Special Function allows you to choose an area code that will be inserted **automatically** before a phone number when you make a call.

If you enter an area code yourself, before a phone number, the automatic area code will, of course, **not** be added to the number, **nor** will it be added to the emergency number **112**, or to a number that begins with an international prefix, or with \* or #.



*You can only use the **Area Code** facility in the country where it was entered and stored.*

### ***Entering and storing the area code:***

1. Press **M** an then enter **17**. “**AREA OFF**” is displayed.
2. Press any numeric key. “**CHG AREA**” is displayed.
3. Press **S**. “**ENTER AREA**” is displayed.
4. Enter the area code you want.
5. To store the area code and turn the **Area Code** facility ON, press **S**, ▲ or ▼.

### ***Turning the Area Code facility ON or OFF:***

1. Press **M** an then enter **17**. The current setting is displayed, either “**AREA CODE**”, together with the area code or “**AREA OFF**”.
2. Press any numeric key. Either “**AREA OFF**” or “**AREA CODE**”, is displayed, together with the area code.
3. Store the new setting by pressing **S**, ▲ or ▼.

### ***Replacing the existing area code:***

1. Press **M** an then enter **17**. Either “**AREA CODE**”, together with the area code, or “**AREA OFF**” is displayed.
2. Press any numeric key **twice**. “**CHG AREA**” is displayed.

Proceed as described under steps **3**, **4** and **5** in ***Entering and storing the area code*** above.

## **18. Battery Discharge**

You can discharge the battery attached to the phone with this Special Function.

1. Press **M** and enter **18**. “**DISCHRG OF**” is displayed.
2. Press any numeric key. “**DISCHRG ON**” is displayed.
3. Press **S** to start discharging the battery.

You can read more about this in the chapter ***Batteries and Recharging***. Refer to the section ***Recharging***.

## **19. Battery Voltage**

You can read off the voltage of the attached battery.

1. Press **M** and then enter **19**. “**VOLT**” is displayed, followed by two digits, which represent the battery voltage.

Note that a space is shown instead of a decimal point. “**6 3**”, for example, means 6.3 volts.

The voltage of a fully charged battery is at least 6.8 – a battery which is almost empty has a voltage of 6.1, or less.

2. Press **C** to leave the Special Functions, or ▲ or ▼ to move on to another Special Function.



## 20. Phone Lock

The **Phone Lock** function allows you to prevent unauthorized use of your phone in the event of a theft.



*Emergency calls (112) can, however, be made when the phone is locked.*

There are two levels of locking the phone: **Full lock** and **Autolock**.

### **Full lock:**

If the full lock is enabled, the message “**PHONE LOCK**” is displayed briefly, followed by the question “**CODE?**”, each time the phone is turned ON. The user then has to enter a **security code** to be able to use the phone.

### **Auto lock:**

If the autolock is enabled, the message “**PHONE LOCK**” and the question “**CODE?**”, will not appear in the display unless a **different SIM** has been inserted in the phone.

After the security code has been entered correctly, the phone can be used with **new** SIM. Not until the **original** SIM or a **different** SIM is inserted in the phone, will the user be asked to enter the security code again.

### **Observe the following:**



*Your phone is factory-programmed with a 4-digit security code of **0000**. To improve security, you*

*should change this to any 3- to 8-digit personalized code.*

*Should you forget your security code, contact an authorized dealer. Be aware of that it, for security reasons, might take same time to solve the problem. You are, therefore, advised to select your security code carefully. You can, for example, use the same code as your PIN, or another code that you will remember easily.*

### **Changing your security code:**

1. Press **M** and then enter **20**. “**PHONE LOCK**” is displayed.
2. Press any numeric key repeatedly until “**CHG CODE**” (Change Code) is displayed.
3. Press **S**. “**OLD?**” is displayed.
4. Enter the **present** security code and press **S**. “**NEW?**” is displayed.
5. Enter the **new** 3- to 8-digit security code and press **S**. “**AGAIN?**” is displayed.
6. Enter the **new** security code again and press **S**.

If you entered the old code and the new code correctly “**NEW CODE**” appears briefly. The display then returns to normal.

If you entered any of the codes incorrectly, a beep is heard and “**ERROR**” is displayed briefly. The display then returns to normal.

### ***Enabling the electronic lock:***

1. Press **M** and then enter **20**. **“PHONE LOCK”** is displayed.
2. Press any numeric key. **“FULL LOCK?”** is displayed. To enable the **full lock**, go to step 4 below.
3. To enable the **autolock**, press the numeric key again. **“AUTOLOCK?”** is displayed.
4. Press **S**. **“CODE?”** is displayed.
5. Enter the 3- to 8-digit security code and press **S**.  
If you entered the code correctly, either **“FULL LOCK”** or **“AUTOLOCK”** is displayed briefly. The display then returns to normal.

If you entered the code incorrectly, a beep is heard and **“ERROR”** is displayed briefly. The display then returns to normal.

### ***Disabling the lock or changing the lock level:***

1. Press **M** and then enter **20**. **“PHONE LOCK”** is displayed.
2. Press any numeric key.  
**“UNLOCK?”** is displayed. To **disable** the lock, go to step 4 below.
3. To **change** the lock level, press the numeric key again. Either **“AUTOLOCK?”** or **“FULL LOCK?”** is displayed.
4. Press **S**. **“CODE?”** is displayed.
5. Enter the 3- to 8-digit security code and press **S**.

If you entered the code correctly, either **“UNLOCKED”**, **“AUTOLOCK”** or **“FULL LOCK”** is displayed briefly. The display then returns to normal.

If you entered the code incorrectly, a beep is heard and **“ERROR”** is displayed briefly. The display then returns to normal.

# Batteries and Recharging

## Batteries

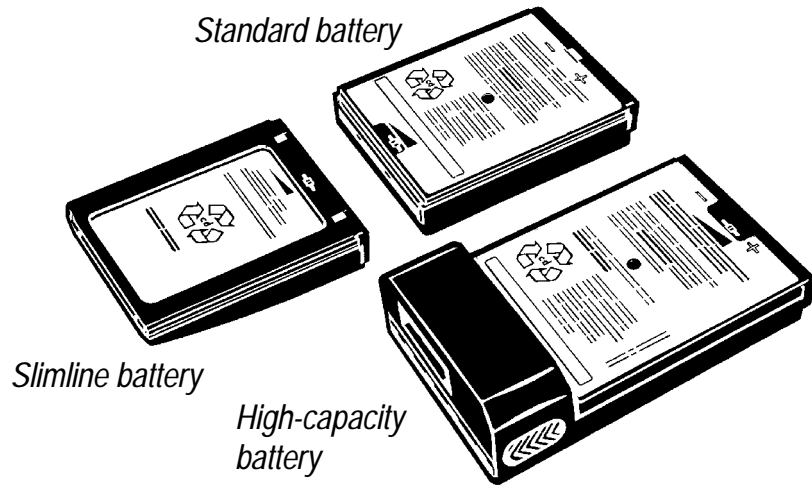

At present, there are three types of battery that can be used with the phone: **standard**, **slimline** and **high-capacity** batteries.

## Battery Meter

The battery meter is shown on the right of the display. The meter reflects the state of charge of the battery attached to the phone.

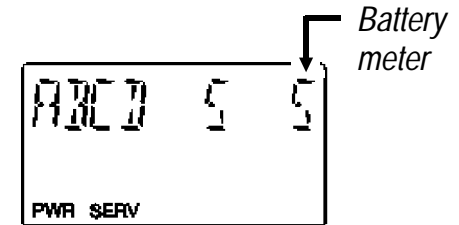

A value of **5** indicates that the battery is fully charged, while a value of **0** indicates that the battery is empty, or almost empty.

## Low Battery Alarm

As a reminder that the battery needs recharging or replacing, a long beep sounds and the message "**LOW BATT**" flashes in the display for ten seconds.



In addition, the indicator light on the top edge of the phone starts **flashing red**.

If the phone is left on, the low battery alarm will be repeated several times and, eventually, the phone will turn itself off.

When the phone has turned itself off, the message “**DISCHARGIN**” flashes in the display and the indicator light on the top of the phone shows a **steady red light**.



This indicates that the phone now discharges the battery. It is not possible to turn the phone on again. Instead, the battery must be recharged or replaced with a charged one.



*If you have the opportunity, do not remove the battery until the message “**DISCHARGIN**” and the red light go out. Refer to the section **Recharging** later in this chapter.*

### **Low battery alarm during a call:**

If the low battery alarm is issued when a call is in progress, you should end the call as quickly as possible. If the call continues, the phone will turn itself off after a short period.

## **Care and Maintenance**

The batteries are of the Nickel-Cadmium type. They have a long maintenance-free service life if properly treated.

- **Never** let a battery get into contact with metal objects that may short-circuit the battery poles, for example a bunch of keys in a pocket.
- A battery may explode if disposed of in a fire.
- Do **not** disassemble a battery.
- If you suspect a battery of **not** working correctly, take it to an authorized dealer.

**Inserting and Removing a Standard or Slimline Battery**

**Removal:**

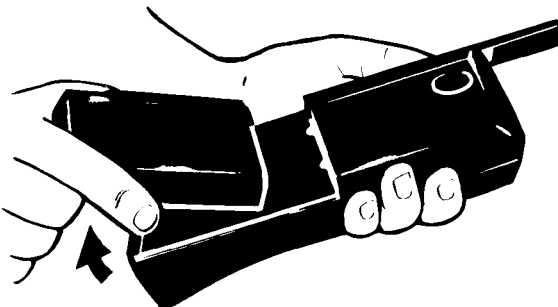
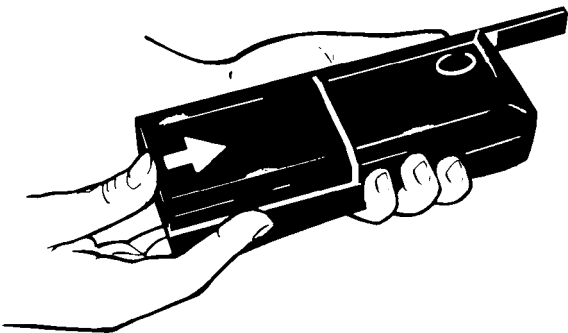

**Insertion:**

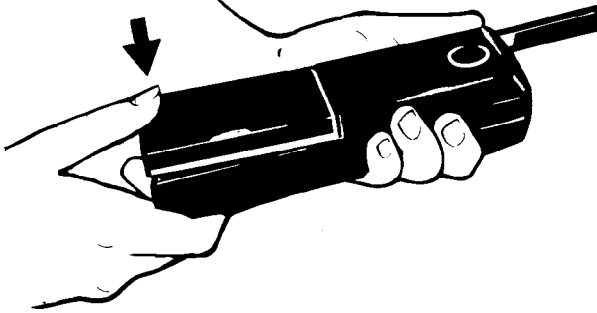
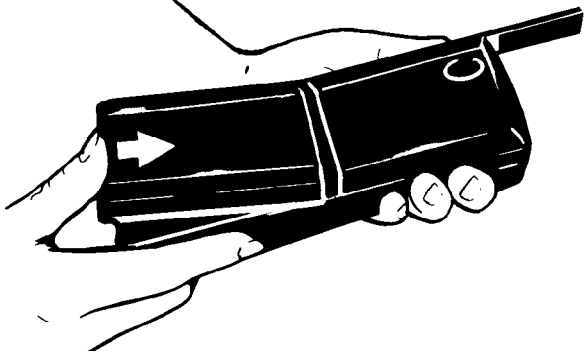

# Inserting and Removing a High-Capacity Battery

*Removal:*

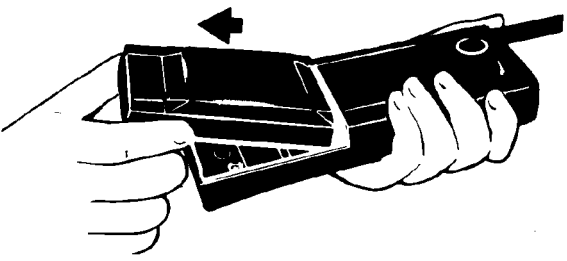
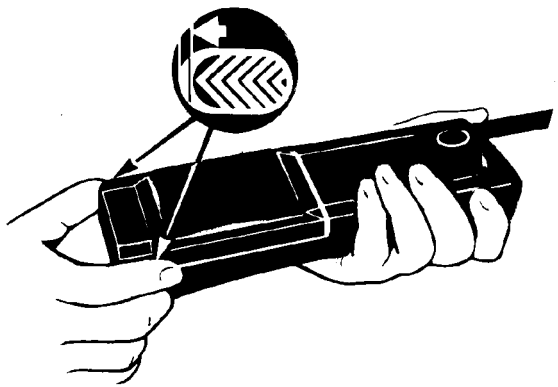

*Insertion:*

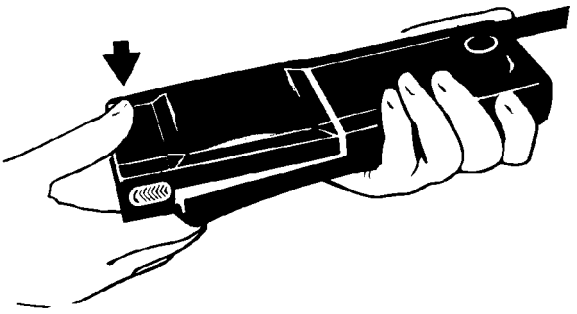
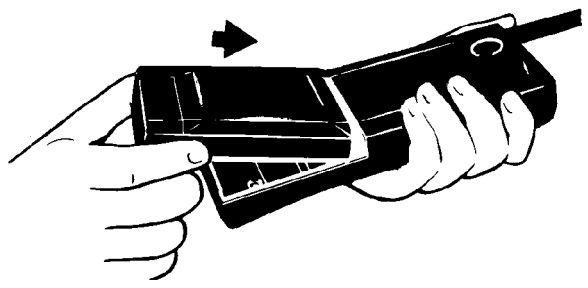

## Slide indicator

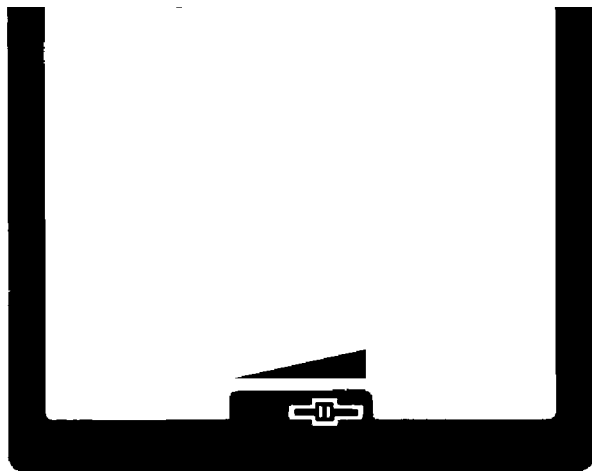

A battery has a slideable indicator which you can use to tell an empty battery from a charged battery. Slide the indicator to the left if the battery is empty -- to the right if the battery is charged.



*If you are uncertain of the state of charge of a battery, attach the battery to the phone. Press and hold down the **Power** key. If the phone does not come on, the battery is probably empty. On the other hand, if the phone comes on, observe the battery meter.*

*If **5** or **4** is shown, the battery is all right.*

***3** or **2** indicates that the battery can be used.*

***1** or **0** indicates that the battery needs recharging.*

## Recharging



*Avoid recharging a battery before the low battery alarm has been issued.*

*If you **often** recharge a battery **before** the low battery alarm has been issued, the battery's ability to accept a charge will be impaired, with the result that the phone can only be used for shorter and shorter periods between recharges.*

***If you have problems with a battery, you can proceed as follows:***

**Do not remove** the battery from the phone. Allow the phone to remain ON until it turns itself OFF, after the low battery alarm has been issued several times.

After the phone has turned itself OFF, it still continues to discharge the battery. In the meantime, the message "**DISCHARGIN**" flashes in the display and the indicator light on the top of the phone shows a **steady red light**.

Do **not** remove the battery from the phone until the message "**DISCHARGIN**" and the red light go out.

After recharging the battery, it can be used for a longer period before the next recharge is required.



*With Special Function No. **18** you can at any time discharge a battery. Proceed as follows:*

1. Attach the battery to be discharged and turn the phone ON.

2. Press **M** (MODE) and enter **18**. “**DISCHRG OF**” is displayed.
3. Press any numeric key. “**DISCHRG ON**” is displayed.
4. Press **S** (STORE). The message “**DISCHARGIN**” flashes and the red light comes on.
5. When “**DISCHARGIN**” and the red light go out, the discharge is complete. Recharge the battery.

### **Basic Charger**

The charger, delivered with the phone, is to be used **indoors** together with an AC/DC converter.

It can, however, only be used to recharge **standard** and **slimline** batteries. To recharge a **high-capacity** battery, you must use the optional Multi Charger. Refer to the chapter **Accessories**.

### **Connecting the basic charger:**



*Use only the AC/DC converter provided with the charger. Use of any other AC/DC converter may be dangerous.*

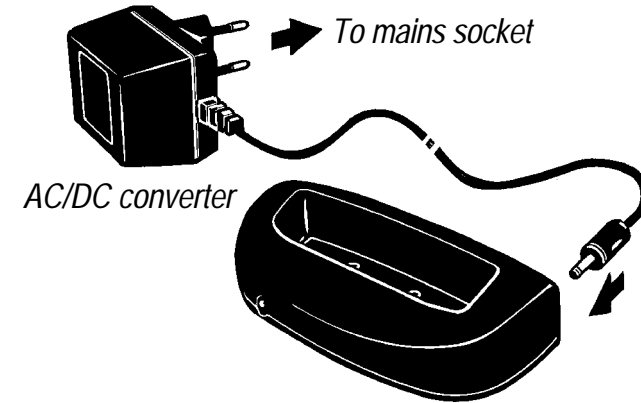

1. Connect the AC/DC converter to the charger.
2. Plug the AC/DC converter into a mains socket.



## **Recharging a standard battery:**



*Never recharge a battery with the basic charger when the ambient temperature is below 0 °C or above 40 °C.*

1. Place the battery in the charger. The indicator light on the charger comes on if the battery is placed correctly.
2. The battery is charged continuously. An empty battery will be fully charged after 8 to 10 hours.



*Avoid lengthy charging times as this can reduce battery life.*

*Indicator light*

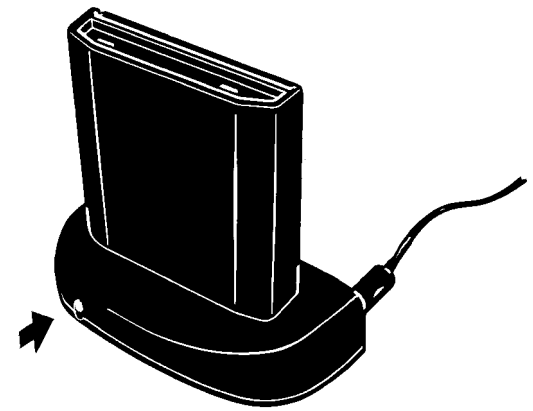

## Hands-Free Vehicle Kit

A hands-free kit is available for vehicular use of your phone. The kit incorporates a complete system for hands-free usage, powering the phone from the vehicle's battery, and recharging the standard or slimline battery attached to the phone. An external antenna can be used for better radio communication.

When the phone rests in the holder, the internal microphone and earpiece are disabled. Instead, an external microphone and an external loudspeaker are used.

The hands-free feature allows you to make or answer calls without removing the phone from the holder. You can comfortably have a telephone conversation and still have both hands on the wheel.

### ***Service Available indicator***

The indicator light on the top edge of the phone shows a **steady green light** when service is available from a GSM network.

### ***Battery charging***

When the phone is ON, the attached battery is charged. In the meantime, a **“C”** (Charging) is shown on the right of the display (instead of the battery meter), to indicate that charging is in progress.

When the battery is fully charged, **“FC”** (Fully Charged) comes on.

### ***Illumination***

The display and keypad are illuminated as long as the phone is ON. You can, however, turn the illumination OFF with Special Function No. **5, Back Light**. Refer to the chapter ***Special Functions***.

### ***Operation***

When the phone is used with the hands-free system, its operation is essentially the same as described earlier in this manual. However, there are some points to be noted.

### ***Any Key facility***

If you turn ON Special Function No. **15, Any Key**, you can press **any** key **except** the **Power** key to answer a call. Refer to the chapter ***Special Functions***.

# Portable Hands Free

The portable hands-free set is plugged into the receptacle at the bottom of the phone. This means that high-capacity batteries cannot be used, only standard and slimline batteries.

## *Any Key facility*

If you turn ON Special Function No. **15, Any Key**, you can press **any** key **except** the **Power** key to answer a call.

Refer to the chapter ***Special Functions***.

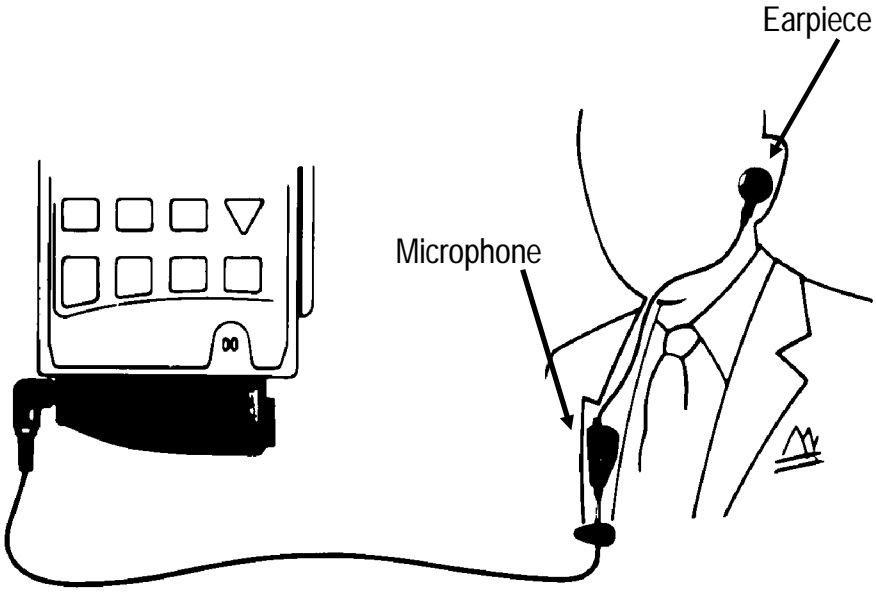

Portable Hands Free

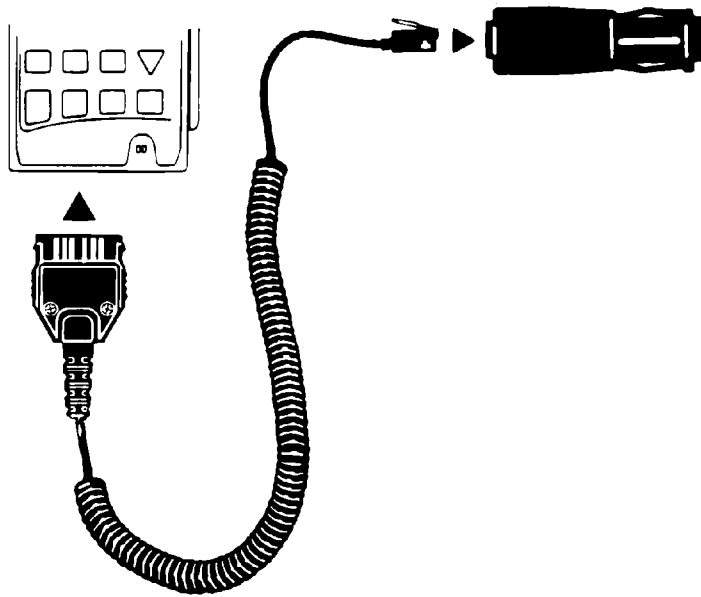

**Vehicle Power Adaptor**

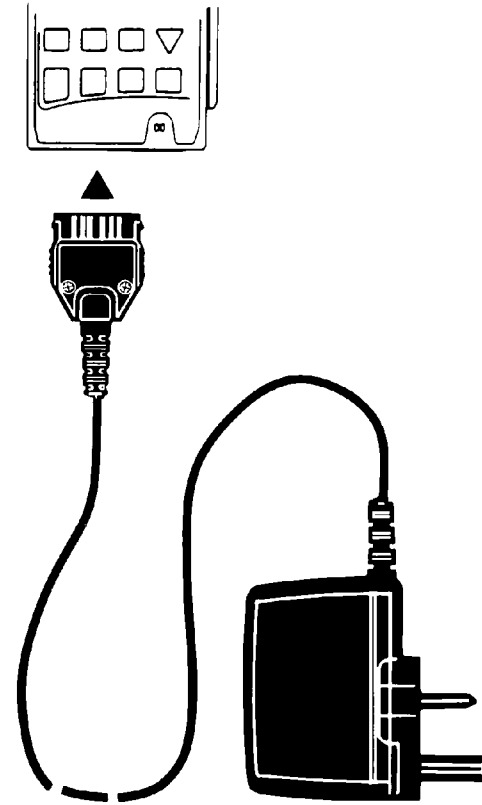

**Rapid Charger**

## **Vehicle Power Adaptor and Rapid Charger**

The vehicle power adaptor, or the rapid charger, both powers the phone and recharges the attached **standard** or **slimline** battery.

The **vehicle power adaptor** is connected to a **12 V, negative earth**, cigarette lighter receptacle in a vehicle.

The **rapid charger** is to be used **indoors**, and it is powered from the mains.

### **Recharging a battery and powering the phone:**

1. Turn OFF the phone.
2. Plug the vehicle power adaptor/rapid charger into the receptacle at the bottom of the phone.
3. Plug the vehicle power adaptor into the cigarette lighter receptacle in the vehicle, or the rapid charger into a mains socket.
4. Turn ON the phone.

The recharging of a battery is controlled by the phone. When the phone is ON, the display and keypad are illuminated continuously. A “**C**” (Charging) is shown on the right of the display (instead of the battery meter), to indicate that charging is in progress.

When the battery is fully charged “**FC**” (Fully Charged) comes on. A slimline battery will be charged within less than 1 hour -- a standard battery within less than 2 hours.



*If the phone does not come on when you turn it ON, the reason may be that the battery is fully discharged. Wait a minute and then turn the phone ON again.*

*If you remove the rapid charger from the mains socket, or the vehicle power adaptor from the cigarette lighter receptacle, also disconnect it from the phone.*

*Some vehicles disable the cigarette lighter when the ignition is turned off.*

### **Using the vehicle power adaptor together with portable hands free:**

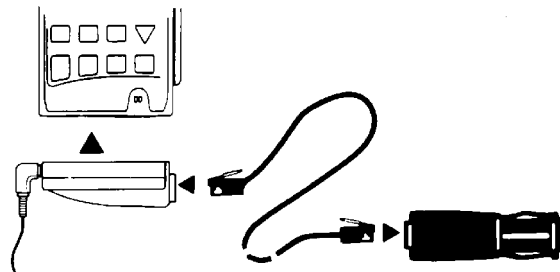

If a portable hands-free set is fitted to the phone, the vehicle power adaptor can be connected with a special cable (included in the Vehicle Power Adaptor package). See the figure above.

# Multi Charger



AC/DC Converter

The multi charger can be used to recharge standard, slimline and high-capacity batteries. It is to be used **indoors** with an AC/DC converter.

It takes less than 1 hour to recharge a slimline battery, less than two hours to recharge a standard battery, and less than 3 hours to recharge a high-capacity battery.

Two batteries can be inserted simultaneously -- one in the horizontal compartment, the other in the vertical compartment. A **slimline** battery cannot, however, be inserted in the vertical compartment.

A **standard** or **high-capacity** battery need not be removed from the phone; the phone can be inserted in the vertical compartment, with battery attached, as shown in the figure above.

The recharging is controlled by a built-in computer. If two batteries are inserted, the battery in the **vertical** compartment will be recharged first, then the battery in the **horizontal** compartment.

When a battery is inserted in the **horizontal** compartment, the computer examines the state of charge of the battery. It then determines whether the battery needs to be **discharged** or not, before recharging takes place.



*Never use the multi charger if the ambient temperature is below 5 °C or above 40 °C*

## Connecting the multi charger:

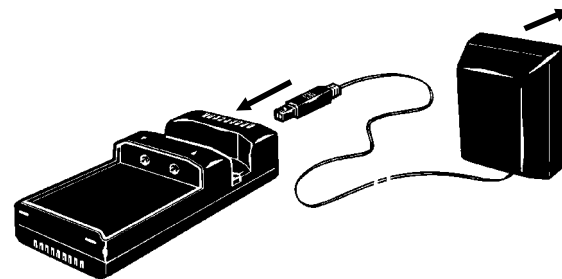

*Use only the AC/DC converter provided with the multi charger. Use of any other AC/DC converter may be dangerous.*

1. Connect the AC/DC converter to the charger.
2. Plug the AC/DC converter into a mains socket.

## Recharging a battery using the horizontal compartment:

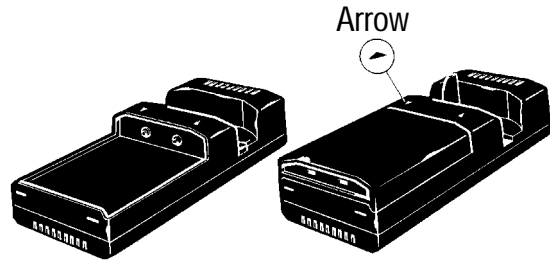

1. Attach the battery in the same way as you would attach it to the phone. See the right-hand figure above.
- 2a. If a **red arrow** on the charger lights up, it indicates that the battery is being **recharged**.
- 2b. If the **red arrow flashes**, it indicates that the battery is being **discharged**. When the red arrow stops flashing and lights continuously, discharging is completed and recharging starts.
3. When a **green arrow** replaces the red arrow, recharging is completed and you can remove the battery. However, no harm will come to the battery if left in the charger. When a battery is fully recharged, the charger changes to trickle-charging.

## Recharging a battery using the vertical compartment:

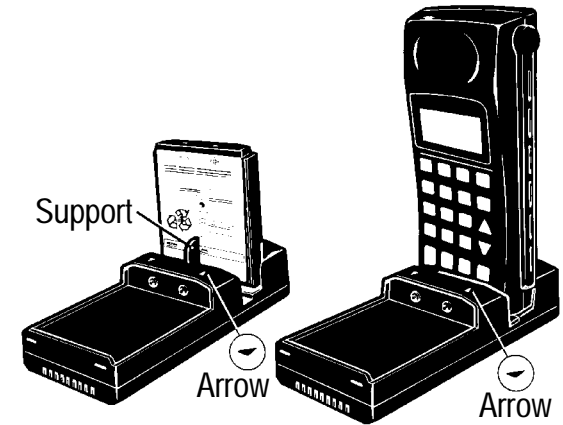

*Slimline batteries cannot be recharged in the vertical compartment, only standard and high-capacity batteries.*

A battery to be recharged can be detached from, or attached to, the phone.

- 1a. If you wish to recharge a **standard** battery, **detached** from the phone, first unfold the little support in the compartment. Then place the battery as shown in the left-hand figure above.
- 1b. If you wish to recharge a battery while it is still **attached** to the phone, place the phone as shown in the right-hand figure. It does not matter whether the phone is ON or OFF.

2. A **red arrow** lights up to indicate that recharging is in progress.
3. When a **green arrow** replaces the red arrow, recharging is completed and you can remove the battery or phone. However, no harm will come to the battery if left in the charger. When a battery is fully recharged, the charger changes to trickle-charging the battery.



*When the phone rests in the vertical compartment, you can, at any time, remove it from the charger to make or answer a call. When the call is ended, replace the phone in the vertical compartment.*



**Observe the following:**

*If, when you insert the first battery in the multi charger, the red arrow does not light up, check that the charger is properly connected to the mains. The reason may also be that the ambient temperature is too low or too high, or that the battery is faulty.*



# Problems You Can Solve

## Phone Does Not Come On

Recharge or replace the battery. Refer to the chapter *Batteries and Recharging*.

If the phone is powered from a cigarette lighter receptacle, using the **Vehicle Power Adaptor**, check that this is properly connected both to the cigarette lighter receptacle and to the receptacle at the bottom of the phone. Refer to the chapter *Accessories*.

*Note that some vehicles disable the cigarette lighter when the ignition is turned off.*

## INSERT SIM Is Displayed

Insert your SIM. Refer to the instructions in the section *Inserting the SIM* at the end of this chapter.

## The SERV Indicator Does Not Come On or the Message NO NETW (No Network) Is Displayed

The phone has not registered on a GSM network and you cannot make or receive any calls. The reason for this is either:

The received signal is too weak. See the next section, *Received Signal Is Weak*.

You are in an area which is not covered by a GSM network.

## The SERV Indicator Flashes

A GSM network is in range but the phone will not register on it. Emergency calls (**112**) can, however, be made.

## Received Signal Is Weak

Move the phone or the car and observe the signal strength reading in the display. The maximum reading is **5**.

The strength of the received signal varies from place to place, and often you need only move the phone by as little as 20 – 25 centimeters to obtain a stronger signal.

Large obstacles such as buildings, hills and mountains can drastically affect the signal strength and you may have to move to obtain a sufficiently strong signal.

Indoors, it is usually best to use the phone near a window. If you use an external antenna, check its connection.

## Flashing Red Indicator Light – Alarm Signal Sounds

*“LOW BATT”* flashes in the display, indicating that the battery is becoming exhausted. Refer to the chapter *Batteries and Recharging*.

## Steady Red Indicator Light

**“DISCHARGIN”** flashes in the display. The phone has turned itself off, after the **“LOW BATT”** alarm has been issued several times. Refer to the chapter **Batteries and Recharging**.

## Changing Your Password

To prevent unauthorized use of the **Call Barring** service, a **Password** must be entered. See the description of Special Function No, **3. Call Barring** in the chapter **Special Functions**.

To change the password, common to all call barring services, proceed as follows:

1. Enter the following sequence:

**\* \* 0 3 \* 3 3 0 \* OLD PASSWORD \* NEW  
PASSWORD \* NEW PASSWORD #**

2. Press **Send**.

## Messages

There are a number of other messages that may be displayed.

**“BARRED”**

An outgoing call has failed because call barring is activated, or the number you have called has barred incoming calls.

**“TMP BARRED”**

Calls are temporarily barred by the network. Try again.

**“BARRING OFF”** (Barring Off)

Call barring is cancelled.

**“BARRING ON”**

Call barring is activated.

**“COMMAND ERROR” – – – “COMMND ERR”**

The network has rejected a request for a service that does not agree with another service already activated, or you have tried to access a service that you have not subscribed to.

**“FORWRD OFF”**

Call forwarding is cancelled.

**“FORWARD ON”**

Call forwarding is activated.

**“FORWARDING”**

You are informed that an incoming call is forwarded to another number.

**“FWD ACTIVE”**

A reminder that call forwarding is activated.

**“FWD IN”**

In incoming call has been forwarded from another phone number.

**“FWD END”**

An outgoing call is forwarded to another number.

**“NETWORK PROBLEM” – – – “NETW PROBL”**

Communication with the network has failed. Try again.

**“PASSWORD ERROR” – – – “PASSW ERR”**

You have entered a wrong password when activating or cancelling a call barring service, or you have made an error when entering the sequence for changing your password.

**“PASSWORD CHANGED” – – – “PASSW CHGD”**

Password changing was successful.

**“SECURITY ERROR” – – – “SIM SECUR” or**

**“UPDATE ERROR” – – – “SIM UPDATE” or**

**“SIM ERROR”**

Communication with the SIM has failed.

**“SIM BLOCKD”**

The PIN has been entered incorrectly three times in succession.

Contact your network operator. He will provide you with the special **Unblocking Key**. This is entered using the following sequence together with a new PIN of your choice:

**\* \* 0 5 \* UNBLOCK KEY \* NEW PIN \* NEW PIN #**

**“SIM UNUSE”**

The SIM is permanently blocked after too many unsuccessful attempts to unblock it. Contact your network operator.

# Inserting the SIM

