

Digital Video Broadcasting (DVB); User guideline for Digital Satellite News Gathering (DSNG) and other contribution applications by satellite

European Broadcasting Union



Union Européenne de Radio-Télévision

DVB
Digital Video
Broadcasting



Reference

DTR/JTC-DVB-83 (bb000ics.PDF)

Keywords

DVB, digital, video, broadcasting, TV, SNG

ETSI

Postal address

F-06921 Sophia Antipolis Cedex - FRANCE

Office address

650 Route des Lucioles - Sophia Antipolis
Valbonne - FRANCE
Tel.: +33 4 92 94 42 00 Fax: +33 4 93 65 47 16
Siret N° 348 623 562 00017 - NAF 742 C
Association à but non lucratif enregistrée à la
Sous-Préfecture de Grasse (06) N° 7803/88

Internet

secretariat@etsi.fr
Individual copies of this ETSI deliverable
can be downloaded from
<http://www.etsi.org>
If you find errors in the present document, send your
comment to: editor@etsi.fr

Copyright Notification

No part may be reproduced except as authorized by written permission.
The copyright and the foregoing restriction extend to reproduction in all media.

© European Telecommunications Standards Institute 1999.
© European Broadcasting Union 1999.
All rights reserved.

Contents

Intellectual Property Rights	4
Foreword	4
Introduction.....	5
1 Scope.....	6
2 References	6
3 Symbols and abbreviations	8
3.1 Symbols	8
3.2 Abbreviations.....	9
4 Analysis of the capabilities of the DVB-DSNG system.....	11
4.1 User's requirements.....	11
4.2 Source coding transport multiplexing and service information.....	11
4.3 Channel coding and modulation.....	13
4.4 Examples of use of the system	16
4.4.1 Link budget - generic hypothesis.....	19
4.4.2 DSNG Examples	21
4.4.3 Fixed contribution links	24
4.4.4 Interfacing with terrestrial telecommunications networks	24
5 Analysis of the co-ordination channels capabilities	26
5.1 Summary of the co-ordination channel system	26
5.2 Examples of use of the DVB-DSNG System with their associated co-ordination channels	30
6 Conclusions	34
Bibliography	35
History.....	36

Intellectual Property Rights

IPRs essential or potentially essential to the present document may have been declared to ETSI. The information pertaining to these essential IPRs, if any, is publicly available for **ETSI members and non-members**, and can be found in SR 000 314: "*Intellectual Property Rights (IPRs); Essential, or potentially Essential, IPRs notified to ETSI in respect of ETSI standards*", which is available **free of charge** from the ETSI Secretariat. Latest updates are available on the ETSI Web server (<http://www.etsi.org/ipr>).

Pursuant to the ETSI IPR Policy, no investigation, including IPR searches, has been carried out by ETSI. No guarantee can be given as to the existence of other IPRs not referenced in SR 000 314 (or the updates on the ETSI Web server) which are, or may be, or may become, essential to the present document.

Foreword

This Technical Report (TR) has been produced by the Joint Technical Committee (JTC) Broadcast of the European Broadcasting Union (EBU), Comité Européen de Normalisation ELECTrotechnique (CENELEC) and the European Telecommunications Standards Institute (ETSI).

NOTE: The EBU/ETSI JTC Broadcast was established in 1990 to co-ordinate the drafting of standards in the specific field of broadcasting and related fields. Since 1995 the JTC Broadcast became a tripartite body by including in the Memorandum of Understanding also CENELEC, which is responsible for the standardization of radio and television receivers. The EBU is a professional association of broadcasting organizations whose work includes the co-ordination of its members' activities in the technical, legal, programme-making and programme-exchange domains. The EBU has active members in about 60 countries in the European broadcasting area; its headquarters is in Geneva.

European Broadcasting Union
CH-1218 GRAND SACONNEX (Geneva)
Switzerland
Tel: +41 22 717 21 11
Fax: +41 22 717 24 81

Digital Video Broadcasting (DVB) Project

Founded in September 1993, the DVB Project is a market-led consortium of public and private sector organizations in the television industry. Its aim is to establish the framework for the introduction of MPEG-2 based digital television services. Now comprising over 200 organizations from more than 25 countries around the world, DVB fosters market-led systems, which meet the real needs, and economic circumstances, of the consumer electronics and the broadcast industry.

Introduction

In modern day broadcasting, dominated by increasing competition, a real-time acquisition of news events (for example sport meetings, interviews, concerts, calamities), in both the domestic and international environments, is a major factor in the search for audience ratings. In this context, Satellite News Gathering (SNG) provided by light weight transmit terminals with small antennas (for example 90 cm to 150 cm) is the solution to establish rapid connections between outside broadcasting units to the TV studios, without requiring a local access to the fixed telecom network.

The commercial introduction of small digital equipment for video and sound compression, advanced error protection and modulation has recently enabled the development of operational *Digital SNG (DSNG) systems* with a number of advantages over the analogue solution. Among these, the most significant are the "*miniaturisation*" of the up-link terminal, the use of lower power (EIRP), and a more efficient use of the frequency spectrum. This digital technology permits the simultaneous transmission of multiple signals through a satellite transponder, significantly increasing the flexibility of transponder access and reducing the cost per channel. The inherent flexibility of the digital solution allows fulfilling the different quality requirements of satellite transmission of news, sport events, and entertainment by operating the video/audio compression algorithm at the appropriate bit-rates. Moreover, the digital system ruggedness against noise and interference offers a constant picture and sound quality at the receiving site.

In 1993-1994 the Digital Video Broadcasting (DVB) Project developed the specification of a digital multi-programme television system for satellite broadcasting DVB-S (EN 300 421 [5]). With the world-wide success of this system, it became more and more clear that it could be suitable also for DSNG applications with significant cost, performance and flexibility advantages over the previous systems.

In July 1997, the Technical Module of the DVB Project set-up an Ad-Hoc Group on DSNG with the tasks:

- to define the specification for modulation/channel coding for DSNG and other contribution applications by satellite (EN 301 210 [1]);
- to define the specification for the auxiliary co-ordination channels (EN 301 222 [2]); and
- to co-operate with other DVB groups for the definition of the user guidelines for Source coding, Service Information (SI) and scrambling for Conditional Access (CA); i.e. the present document.

This standardization activity has led to the definition of a flexible DVB-DSNG system, which can offer a range of different picture quality levels at various bit-rates and of different modulation and channel coding schemes.

1 Scope

The purpose of the present document is to facilitate the interpretation of the technical concepts included in the DVB specifications related to DSNG transmission:

- Framing structure, channel coding and modulation for Digital Satellite News Gathering (DSNG) and other contribution applications by satellite (EN 301 210 [1]); and
- Co-ordination channels associated with Digital Satellite News Gathering (DSNG) (EN 301 222 [2]).

The present document gives an overview of the technical and operational issues relevant to the system, including service quality and link availability evaluation for typical DSNG and fixed contribution links.

2 References

The following documents contain provisions which, through reference in this text, constitute provisions of the present document.

- References are either specific (identified by date of publication, edition number, version number, etc.) or non-specific.
- For a specific reference, subsequent revisions do not apply.
- For a non-specific reference, the latest version applies.
- A non-specific reference to an ETS shall also be taken to refer to later versions published as an EN with the same number.

- [1] EN 301 210: "Digital Video Broadcasting (DVB); Framing structure, channel coding and modulation for Digital Satellite News Gathering (DSNG) and other contribution applications by satellite".
- [2] EN 301 222: "Digital Video Broadcasting (DVB); Co-ordination channels associated with Digital Satellite News Gathering (DSNG)".
- [3] ISO/IEC 13818-1: "Information technology - Generic coding of moving pictures and associated audio information: Systems".
- [4] ISO/IEC 13818-2: "Information technology - Generic coding of moving pictures and associated audio information: Video".
- [5] EN 300 421: "Digital Video Broadcasting (DVB); Framing structure, channel coding and modulation for 11/12 GHz satellite services".
- [6] EN 50083-9: "Interfaces for CATV/SMATV Headends and similar Professional Equipment".
- [7] ETR 154: "Digital Video Broadcasting (DVB); Implementation guidelines for the use of MPEG-2 Systems, Video and Audio in satellite, cable and terrestrial broadcasting applications".
- [8] EN 300 468: "Digital Video Broadcasting (DVB); Specification for Service Information (SI) in DVB systems".
- [9] TBR 30 (1997): "Satellite Earth Stations and Systems (SES); Satellite News Gathering (SNG) Transportable Earth Stations (TES) operating in the 11-12/13-14 GHz frequency bands".
- [10] ETS 300 327: "Satellite Earth Stations and Systems (SES); Satellite News Gathering (SNG) Transportable Earth Stations (TES) (13-14/11-12 GHz)".

- [11] ETS 300 673 (1997): "Radio Equipment and Systems (RES); ElectroMagnetic Compatibility (EMC) standard for 4/6 GHz and 11/12/14 GHz Very Small Aperture Terminal (VSAT) equipment and 11/12/13/14 GHz Satellite News Gathering (SNG) Transportable Earth Station (TES) equipment".
- [12] ETS 300 813: "Digital Video Broadcasting (DVB); DVB interfaces to Plesiochronous Digital Hierarchy (PDH) networks".
- [13] ETR 162: "Digital Video Broadcasting (DVB); Allocation of Service Information (SI) codes for DVB systems".
- [14] ETR 211: "Digital Video Broadcasting (DVB); Guidelines on implementation and usage of Service Information (SI)".
- [15] ITU-R Recommendation BT.1121-1 (1995): "User requirements for the transmission through contribution and primary distribution network of digital HDTV signals".
- [16] ITU-R Recommendation BT.1205 (1995): "User requirements for the quality of baseband SDTV and HDTV signals when transmitted by digital satellite news gathering (SNG)".
- [17] ITU-R Recommendation SNG.722-1 (1992): "Uniform technical standards (analogue) for Satellite News Gathering (SNG)".
- [18] ITU-R Recommendation SNG.770-1 (1993): "Uniform operational procedures for Satellite News Gathering (SNG)".
- [19] ITU-R Recommendation SNG.771-1 (1993): "Auxiliary coordination satellite circuits for SNG terminals".
- [20] ITU-R Recommendation SNG.1007-1 (1995): "Uniform technical standards (digital) for Satellite News Gathering (SNG)".
- [21] ITU-R Recommendation SNG.1070 (1993): "An automatic transmitter identification system (ATIS) for analogue-modulation transmissions for Satellite News Gathering and outside broadcasts".
- [22] ITU-R Recommendation SNG.1152 (1995): "Use of digital transmission techniques for Satellite News Gathering (SNG) (sound)".
- [23] Void.
- [24] ITU-T Recommendation G.729: "Coding of speech at 8 kbit/s using conjugate-structure algebraic-code-excited linear-prediction".
- [25] ITU-T Recommendation V.11: "Electrical characteristics for balanced double-current interchange circuits operating at data signalling rates up to 10 Mbit/s".
- [26] ANSI/EIA RS232E: "Interface between data terminal equipment and data-circuit terminating equipment employing serial binary data interchange".
- [27] ITU-T Recommendation G.702: "Digital hierarchy bit rates".
- [28] EBU technical Review (1998): "New DVB standard for DSNG and contribution satellite links", A. Morello, V. Mignone.
- [29] ETR 289: "Digital Video Broadcasting (DVB); Support for use of scrambling and Conditional Access (CA) within digital broadcasting systems".
- [30] TR 102 154: "Digital Video Broadcasting (DVB); Implementation guidelines for the use of MPEG-2 Systems, Video and Audio in satellite, cable and terrestrial contribution broadcasting applications".

3 Symbols and abbreviations

3.1 Symbols

For the purposes of the present document, the following symbols apply:

a	Roll-off factor
Δ	E_b/N_0 degradation at the target BER
Γ	Ratio of the spectrum density of the DSNG signal and of each co-ordination signal divided by the spreading factor L
η	Modulation/coding spectral efficiency (bits per transmitted symbol)
Φ	Antenna diameter
ρ	Is a parameter related to the ratio between C/N and C/I
A	Interference power suppression of each co-ordination channel by the baseband filter of the DSNG receiver
C/N	Carrier-to-noise power ratio
C/I	Carrier-to-interference power ratio
d_{free}	Convolutional code free distance
d_{free}	Convolutional code free distance
E_b/N_0	Ratio between the energy per useful bit and twice the two sided noise power spectral density
f_0	Centre frequency of a modulated signal
f_N	Nyquist frequency
f_N	Nyquist frequency
$g(x)$	RS code generator polynomial
G_1, G_2	Convolutional code generators
G_{LR}, G_{LS}	ML-sequence generators
G_{SS1}, G_{SS2}	Spreading sequences generators
$H(f)$	Baseband square root Raised Cosine filtering in the modulator
I	Interleaving depth [bytes]
I, Q	In-phase, Quadrature phase components of the modulated signal
j	Branch index of the interleaver
K	Convolutional code constraint length
k/n	Rate of the punctured convolutional code
L	Spreading sequence length (Spreading Factor) (bit)
m	Number of transmitted bits per constellation symbol
M	Convolutional interleaver branch depth for $j = 1$, $M = N/I$
M	Number of co-ordination carriers transmitted in CDMA configuration
N	Error protected frame length (bytes)

$p(x)$	RS field generator polynomial
R	Useful bit-rate before multiplexer
r_m	In-band ripple (dB)
R_s	Symbol rate corresponding to the bilateral Nyquist bandwidth of the modulated signal
R_s	Symbol rate corresponding to the bilateral Nyquist bandwidth of the modulated signal before spread-spectrum
$R_{s,chip}$	Chip symbol rate corresponding to the bilateral Nyquist bandwidth of the modulated signal after SS
R_{TCM}	Rate of the trellis code
R_u	Useful bit rate after MPEG-2 (ISO/IEC 13818-1[3]) transport multiplexer, referred to the 188 byte format
R_u	Useful bit-rate after multiplexer, before channel encoder
$R_u(204)$	Bit rate after RS outer coder, referred to the 204 byte format
T	Number of bytes which can be corrected in RS error protected packet
T_s	Symbol period
T_s	Period of unspread symbol
$T_{s,chip}$	Period of the spread symbol, equal to $1/R_{s,chip}$
U	Number of channels at the MUX input ($U = 1, 2, 4$)
X,Y	Di-bit stream after rate 1/2 convolutional coding

NOTE 1: The sub-script "COOR" refers to the co-ordination signals.

NOTE 2: The sub-script "DSNG" refers to the main DSNG signal.

3.2 Abbreviations

For the purposes of the present document, the following abbreviations apply:

16QAM	16 points Quadrature Amplitude Modulation
1CBPS	1 Coded Bit Per Symbol
2CBPS	2 Coded Bits Per Symbol
422P@ML	422 Profile at Main level video format
8PSK	Eight Phase Shift Keying
ADPCM	Adaptive Differential Pulse code modulation
ATM	Asynchronous Transfer Mode
AWGN	Additive White Gaussian Noise
BB	Baseband
BER	Bit Error Ratio
BS	Bandwidth of the frequency Slot allocated to a service
BSS	Broadcast Satellite Service
BW	Bandwidth (at -3 dB) of the transponder
CA	Conditional Access
CCITT	International Telegraph and Telephone Consultative Committee
CDMA	Code Division Multiple Access
DCT	Discrete Cosine Transform
DEMUX	De-multiplexer
DPCM	Differential Pulse Code Modulation
DSNG	Digital Satellite News Gathering
DS-SS	Direct-Sequence Spread-Spectrum
DTH	Direct To Home
DVB	Digital Video Broadcasting
DVB-S	Refers to the DVB Specification for Satellite services (EN 300 421 [5])
EBU	European Broadcasting Union
EIRP	Equivalent Isotropic Radiated Power
EPG	Electronic Program Guide
ETS	European Telecommunication Standard
ETSI	European Telecommunications Standard Institute
FDM	Frequency Division Multiplex
FDMA	Frequency Division Multiple Access
FEC	Forward Error Correction

FIFO	First-In, First-Out shift register
FSS	Fixed Satellite Service
G/T	Gain-to-noise temperature ratio
GOP	Group-of-Pictures
HDTV	High Definition Television
HEX	Hexadecimal notation
IBO	Input Back Off
IF	Intermediate Frequency
IMUX	Input Multiplexer - Filter
IPFD	Input power flux density
IRD	Integrated Receiver Decoder
ITU	International Telecommunications Union
MCPC	Multiple Channels Per Carrier
MP@ML	Main Profile at Main level video format
MPEG	Moving Pictures Experts Group
MSB	Most Significant Bit
MUX	Multiplex
OBO	Output Back Off
OCT	Octal notation
OMUX	Satellite transponder Output Multiplexer – Filter
P	Puncturing
P/P	Parallel-to-parallel
P/S	Parallel-to-serial
PAL	Phase Alternating line
PCM	Pulse-Code Modulation
PDH	Plesiochronous Digital Hierarchy
ppm	parts per million
PRBS	Pseudo Random Binary Sequence
PSI	Program Specific Information
PSK	Phase Shift Keying
PSTN	Public Switched Telephone Network
QEF	Quasi-Error-Free
QPSK	Quaternary Phase Shift Keying
R	Randomized sequence
RF	Radio Frequency
RS	Reed-Solomon
SCPC	Single Channel Per Carrier
SI	Service Information
SMATV	Satellite Master Antenna Television
SNG	Satellite News Gathering
SS	Spread Spectrum
TBD	To Be Defined
TCM	Trellis Coded Modulation
TDM	Time Division Multiplex
TS	Transport Stream
TV	Television
TWTA	Travelling Wave Tube Amplifier
VBI	Vertical Blocking Interval

4 Analysis of the capabilities of the DVB-DSNG system

4.1 User's requirements

Using the same terminology as that of the ITU, the DVB has adopted the following definition of ITU-R Recommendation SNG.722-1 [17]: "Temporary and occasional transmissions with short notice of television or sound for broadcasting purposes, using highly portable or transportable up-link earth stations...").

The DSNG up-link terminals should be highly reliable and have reduced size and weight, while the receiving station may be appropriately dimensioned to ensure the required link availability. Therefore the transmission format should provide high ruggedness against noise and interference and best exploitation of satellite capacity.

High intervention promptness and low set-up complexity is required. In particular, "the equipment should be capable of being set up and operated by a crew of no more than two people within a reasonably short time (for example, one hour)". Interoperability between different pieces of equipment is another key feature for DSNG, especially in an international programme exchange environment. In particular, the DVB has identified in the complexity of the DVB/MPEG SI/PSI tables a possible source of problems for DSNG, affecting equipment interoperability and fast link set up.

For DSNG links, the typical bit-rate used by flyaway and small transportable terminals are about 8 Mbit/s, using MPEG-2 MP@ML. However for transportable stations, when higher quality and enhanced editing facilities are required, "use of MPEG-2 422P@ML should be supported. ... In this case, bit-rates should be higher than 8 Mbit/s and lower than 34 Mbit/s". Regarding Multiplexing, although DSNG transmissions usually transport a single TV programme and associated sound signals (SCPC, Single Channel Per Carrier), "advantage should be taken of the flexibility of the MPEG-DVB multiplex" to convey multiple programmes (MCPC, Multiple Channels Per Carrier).

The processing delays of digital compression systems may be very high (even exceeding one second), especially with the sophisticated coding algorithms allowing high bit-rate compression ratios. Short video coding delays are important characteristics for those applications where the DSNG transmission is mixed together with a live programme, since long delays would prevent dialogues between journalists in the studio and in the field.

Optionally, the DSNG equipment should be capable of providing two or more duplex co-ordination (communication) circuits by satellite as described in EN 301 222 [2], whenever possible in the same transponder as the main DSNG signal. These channels should be available prior to, during and after the DSNG transmission to connect the DSNG operator, the satellite operator and the broadcaster. This equipment may be also used for data transmission and fax. Examples of the use of the system with co-ordination channels are provided in clause 5 of the present document.

Regarding the equipment cost, the DVB pointed out that "the total cost of the system and its operation should be considered, and not just the receiver cost. A non-negligible part of the overall cost of a SNG transmission lies in the requirements for satellite capacity. Modulation techniques, additional to QPSK, such as 8PSK and 16QAM, should be investigated to optimize the efficient use of satellite capacity".

4.2 Source coding transport multiplexing and service information

The DVB has developed a series of User Guidelines for the implementation of MPEG-2 in contribution applications TR 102 154 [30].

Picture Coding

The MPEG-2 Main Profile at Main Level (MP@ML) may be used as the baseline solution for picture coding in DSNG applications. It allows high flexibility for DSNG applications, being able to operate with variable bit-rates from 1,5 Mbit/s to 15 Mbit/s.

The MPEG-2 codecs are based on Hybrid DPCM/DCT algorithms with motion compensation, operating on I-frames (intra), P-frames (predicted) and B-frames (bi-directional prediction). It should be noted that MPEG-2 MP@ML is a 4:2:0 system and was designed for distribution rather than contribution. MPEG-2 MP@ML at bit-rates from 6 Mbit/s with IBBOP GOP structure allows, for current programme material, a subjective quality equivalent to PAL and 4:2:2 pictures, respectively. Lower bit-rates may be acceptable for specific applications, where power and bandwidth limitations are dominant over the picture quality requirements.

In 1995, the MPEG-2 Committee defined a picture coding "profile" to fulfil the requirements of the production environment, which is named 422P@ML. It offers a number of additional features compared to the MP@ML format: the coding rate can be increased up to 50 Mbit/s, the chrome components maintain the 4:2:2 format as the uncompressed studio format. This allows higher picture quality, better chrome resolution, post-processing after co-decoding, short GOP to improve editability in compressed form and to shorten the coding delay. Subjective quality tests (non-expert viewers, 4H distance) have been carried out by the RAI Research Centre and other organizations (See annex A, article 9) on computer simulated 422P@ML sequences, with single and multiple generations (8 co-decoding processes) and colour matte post-processing.

In conclusion, to fulfil the wide range of picture quality levels and bit-rates required by DSNG and other contribution applications, MPEG-2 MP@ML at bit-rates from 1,5 Mbit/s to 15 Mbit/s can cover the applications where no (or very limited) post-processing is performed in the studio before re-broadcasting, while MPEG-2 422P@ML at bit-rates from 15 Mbit/s to 30 Mbit/s can cover the high quality applications, where post-production and cascaded co-decoding are required.

Audio Coding

As regards the sound, all the DVB systems, in line with the trend toward international standardization, adopt the MPEG audio layer II coding method which allows a wide range of bit-rates (for example from 64 kbit/s to 256 kbit/s) satisfying the various service requirements. Bit-rates as low as 64 kbit/s may be applicable for some DSNG applications with mono channels. The optional use of linear (uncompressed) audio coding is also under evaluation by DVB, for contribution applications requiring maximum audio quality.

Transport Multiplexing and Service Information (SI)

The DVB-S system adopts a common framing structure, based on the MPEG-2 transport multiplex, with fixed length packets of 188 bytes, including 1 sync byte, 3 header bytes and 184 useful bytes. This structure allows easy interworking between broadcast channels and telecom networks using ATM protocols.

The MPEG-2 multiplex is very flexible for merging in the Transport Stream (TS) a variety of video, sound and data services, as well as additional information (for example Service Information). Therefore it allows SCPC as well as MCPC services.

The DVB-MPEG Service Information tables, defined for broadcasting applications, describe in detail the multiplex configuration and the programme content, and allow the user to easily access a wide programme offer through the Electronic Programme Guide (EPG). Annex D of the DSNG specification EN 301 210 [1] deals with a simplified Service Information mechanism, based on few fixed tables, avoiding the need to compile SI information in the field, in order to accelerate the link set up and to simplify interoperability problems. Up-link station identification is also provided, for emergency interference situations.

Scrambling for security applications

For some DSNG applications, and for simplicity and maximum interoperability, the DSNG specification EN 301 210 [1] may be used with no security based scrambling. For many other DSNG applications scrambling will be necessary. The DVB has identified a variant of the Common Scrambling Algorithm (see ETR 289 [29]) suitable for DSNG and other contribution applications.

4.3 Channel coding and modulation

Efficient and reliable transmission of digital television signals over satellite channels is focused on the design of the "channel adapter", which performs the adaptation of the multiplexed video/audio/data bit stream to the physical channel, by adopting powerful channel coding and modulation techniques. The specified system offers many transmission modes (inner coding and modulations), giving different trade-offs between power and spectrum efficiency. QPSK modulation has been adopted, and optionally 8PSK and 16QAM modulations, and the concatenation of convolutional and Reed Solomon codes. The QPSK mode is compliant with the DVB-S system defined in EN 300 421 [5], while for 8PSK and 16QAM, "pragmatic" trellis coding (see annex article 10) has been applied, optimizing the error protection of the same convolutional code. The QPSK and 8PSK modes, thanks to their quasi-constant envelope, are appropriate for operation with close to saturated satellite power amplifiers, in single carrier per transponder configuration. 16QAM (as well as QPSK and 8PSK) is appropriate for operation in quasi-linear satellite channels, in multi-carrier Frequency Division Multiplex (FDM) type applications, with high spectrum efficiency.

For DSNG applications the usual method of accessing the transponders is Frequency Division Multiplexing (FDM), where part of the transponder bandwidth (frequency slot) is allocated to each signal. In order to reduce the effect of intermodulation noise introduced on adjacent carriers occupying the same transponder, the TWTA should be operated significantly below the saturation point. The linearity requirements are raised also by the fact that the aggregated FDM signal is no longer characterized by a constant envelope, even if each individual signal has quasi-constant envelope (for example QPSK or 8PSK). The higher is the spectrum efficiency of the modulation/coding scheme, the more stringent are the linearity requirements, because of the reduction of the system ruggedness against interference.

In relation with 8PSK and 16QAM, the DVB-DSNG specification EN 301 210 [1] gives some warnings that are here reproduced:

- they require higher transmitted EIRPs and/or receiving antenna diameters, because of their intrinsic sensitivity to noise and interference;
- they are more sensitive to linear and non-linear distortions; in particular 16QAM cannot be used on transponders driven near saturation;
- they are more sensitive to phase noise, especially at low symbol rates; therefore high quality frequency converters should be used;
- the System modulation/coding schemes are not rotationally invariant, so that "cycle-slips" and "phase snaps" in the chain can produce service interruptions; therefore frequency conversions and demodulation carrier recovery systems should be designed to avoid cycle-slips and phase snaps.

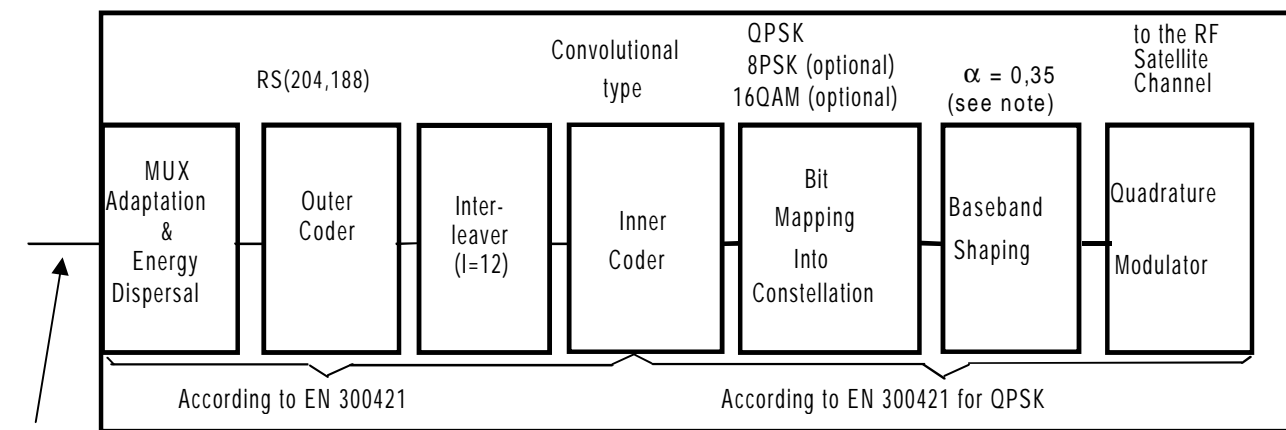

MPEG-2 Source Coding and Multiplexing

Satellite Channel Adapter

NOTE: $\alpha = 0,25$ for 8PSK and 16QAM (additional and optional).

Figure 1: Functional block diagram of the System

Figure 1 gives a functional block diagram of the transmission system. The input stream, organized in 188 bytes packets following the MPEG-2 transport multiplexer ISO/IEC 13818-1 [3], is bit by bit randomized through a scrambling PRBS, in order to comply with the Radio Regulations interference requirements, which impose to have a regular spectrum shape of the transmitted signal, and to facilitate clock recovery in the receiver. Then the Reed-Solomon RS (204,188, t = 8) shortened code (derived from the original RS (255, 239, t = 8)), is applied to each randomized transport packet. Since, on the receiver side, the residual errors at the output of the Viterbi decoder are not statistically independent, but grouped in burst which may overload the RS code correction capability, the error distribution is randomized through a convolutional interleaver with depth I equal to 12 bytes applied to the error protected packets. The interleaved packets are then passed to the convolutional encoder, which is based on a rate 1/2 convolutional code with constraint length equal to 7 (64 trellis states), and allows the selection of the most appropriate level of error correction for a given service or data rate. Punctured convolutional coding is associated with QPSK modulation (according to the DVB-S system specification EN 300 421 [5] with the possibility to operate at five possible rates: 1/2, 2/3, 3/4, 5/6, 7/8; pragmatic Trellis Coded Modulations (TCM) is associated with 8PSK and 16QAM. The principle of the pragmatic trellis encoder is shown in figure 2.

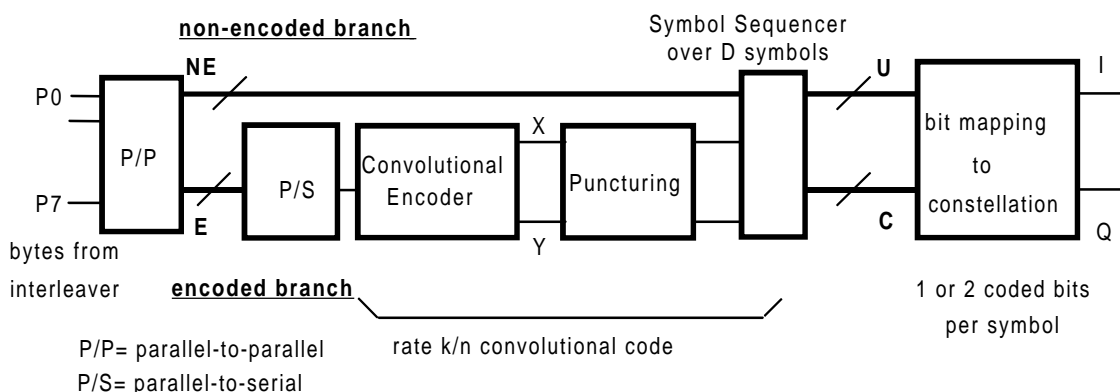

Figure 2: Inner trellis coder principle

The byte-parallel stream at the output of the convolutional interleaver is conveyed to a parallel-to-parallel converter, which splits the input bits into two branches, depending on the selected modulation/inner coding mode. The schemes of the parallel-to-parallel converters have been selected and designed in order to reduce, on average, the byte error-ratio at the input of the Reed-Solomon decoder (high concentration of bit-errors in bytes), and therefore the bit error ratio (BER) after RS correction is reduced. The 8PSK 5/6 and 8/9 schemes are characterized by 1 Coded Bit Per Symbol (1CBPS), while 8PSK 2/3 and 16QAM 3/4 and 7/8 schemes have 2 Coded Bits Per Symbol (2CBPS). The optimum bit mapping to constellation is different for 1CBPS and 2CBPS. The selection of the trellis coding schemes, from a number of different proposals, was based on accurate computer simulations carried-out by the RAI Research Centre. The selected schemes are the ones offering the best performance on a linear channel affected by Additive White Gaussian Noise (AWGN). In the cases of equal performance 1CBPS schemes have been preferred, since they require lower processing speed of the TCM Viterbi decoder compared to 2CBPS schemes, and therefore allows the implementation of higher speed modems (for high quality contribution applications or MCPC transmissions).

Finally baseband shaping and quadrature modulation is applied to the signal. Square-root raised-cosine baseband shaping with a roll-off factor $\alpha = 0,35$ is considered for all constellations, like in the DVB-S system EN 300 421 [5]. An additional roll-off factor $\alpha = 0,25$ may be used for the 8PSK and 16QAM modulations, to increase the spectrum efficiency in the transponder bandwidth. This choice was based on extensive computer simulations, including the satellite TWTA effects.

Error performance

Sensitivity to transmission noise is expressed by the E_b/N_0 ratio required to achieve a target residual BER. E_b is the energy per useful bit and N_0 is the spectral density of the AWGN. The DVB-DSNG system has been designed to provide a quasi-error free quality target, i.e. less than one incorrect error-event per transmission hour at the input of the MPEG-2 demultiplexer. This target, achievable by interleaving and by RS error correction, corresponds approximately to a bit error ratio (BER) of 2×10^{-4} at the output of the TCM/Viterbi decoder. It should be noted that these evaluations take into account stationary noise only and ideal demodulation, while the effects of phase noise and carrier recovery instabilities might generate burst of uncorrectable errors separated by large time intervals. Since the DVB-DSNG coding schemes are not rotationally invariant (to optimize the BER performance), care should be taken in the design of frequency converters and carrier recovery systems, to avoid "cycle skipping" and "phase snaps", which may produce service interruptions.

Table 1 gives the IF Loop system performance requirements for the different modes, in terms of the required E_b/N_0 to provide $BER = 2 \times 10^{-4}$ (Quasi Error Free quality target). The figures of E_b/N_0 are referred to the useful bit-rate R_u (188 byte format, before RS coding), and take into account the factor $10 \text{ Log } 188/204 \sim 0,36 \text{ dB}$ due to the Reed-Solomon outer code and the modem implementation margins. For QPSK the figures are derived from EN 300 421 [5]. For 8PSK and 16QAM, modem implementation margins which increase with the spectrum efficiency are adopted, to cope with the larger sensitivity associated with these schemes.

Table 1: IF-Loop performance of the DSNG System

Modulation	Inner code rate	Spectral efficiency (bit/symbol)	Modem implementation margin [dB]	Required E_b/N_0 for $BER = 2 \times 10^{-4}$ before RS QEF after RS [dB]
	1/2	0,92	0,8	4,5
	2/3	1,23	0,8	5,0
QPSK	3/4	1,38	0,8	5,5
	5/6	1,53	0,8	6,0
	7/8	1,61	0,8	6,4
8PSK	2/3	1,84	1,0	6,9
(optional)	5/6	2,30	1,4	8,9
	8/9	2,46	1,5	9,4
16QAM	3/4	2,76	1,5	9,0
(optional)	7/8	3,22	2,1	10,7

NOTE 1: Quasi-Error-Free (QEF) means approximately less than one uncorrected error event per hour at the input of the MPEG-2 demultiplexer.

NOTE 2: 8PSK 8/9 is suitable for satellite transponders driven near saturation, while 16QAM 3/4 offers better spectrum efficiency for quasi-linear transponders, in FDMA configuration.

NOTE 3: The bit error ratio (BER) of 2×10^{-4} before RS decoding corresponds approximately to a byte error ratio between 7×10^{-4} and 2×10^{-3} depending on the coding scheme.

4.4 Examples of use of the system

One of the main feature of the DVB-DSNG system is the flexibility, allowing to select the modulation, the symbol rate and the coding rate in order to optimize the satellite link performance (i.e. the spectral occupation on the satellite transponder and the power requirements) on a case-by-case basis. On the other hand, in order to achieve rapid interoperability and link set-up in emergency situations, the DSNG specification mandates that at least one "user-definable" set-up is available in DSNG equipment. This set-up includes video/audio coding parameters, modulation scheme and symbol rate.

DSNG applications usually exploit the satellite bandwidth in FDM configuration, nevertheless the DSNG system is suitable also for single carrier per transponder transmissions. In single carrier per transponder configurations, the transmission symbol rate R_s can be matched to given transponder bandwidth BW (at -3 dB), to achieve the maximum transmission capacity compatible with the acceptable signal degradation due to transponder bandwidth limitations. To take into account possible thermal and ageing instabilities, reference can be made to the frequency response mask of the transponder.

In multi-carrier FDM configuration, R_s can be matched to the frequency slot BS allocated to the service by the frequency plan, to optimize the transmission capacity while keeping the mutual interference between adjacent carriers at an acceptable level.

Table 2 and figures 3a and 3b give examples of the maximum useful bit rate capacity R_u achievable by the System versus the allocated bandwidths BW or BS. R_s (symbol rate) corresponds to the -3dB bandwidth of the modulated signal. $R_s(1 + \alpha)$ corresponds to the theoretical total signal bandwidth after the modulator. In these examples the adopted BW/ R_s or BS/ R_s ratios are $1 + \alpha = 1,35$ where α is the roll-off factor of the modulation. This choice allows to obtain a negligible E_b/N_0 degradation due to transponder bandwidth limitations, and also to adjacent channel interference on a linear channel. Higher bit-rates can be achieved with the narrow roll-off factor $\alpha = 0,25$ (optional for 8PSK and 16QAM) and BW/ R_s or BS/ R_s equal to $1 + \alpha = 1,25$.

BW/ R_s or BS/ R_s ratios different from $1 + \alpha$ may be adopted for different service requirements, but the use of lower figures to improve the spectrum exploitation should be carefully studied on a case-by-case basis, to avoid severe performance degradations.

Table 2: Examples of maximum bit rates versus transponder bandwidth BW or frequency slot BS, for BW/R_s or $BS/R_s = \eta = 1,35$

BW or BS [MHz]	$R_s =$ BW/1,35 [MBaud]	R_u [Mbit/s]									
		QPSK					8PSK			16QAM	
		rate 1/2	rate 2/3	rate 3/4	rate 5/6	rate 7/8	rate 2/3	rate 5/6	rate 8/9	rate 3/4	rate 7/8
72	53,333	49,1503	65,5338	73,7255	81,9172	86,0131	98,3007	122,876	131,068	147,451	172,026
54	40,000	36,8627	49,1503	55,2941	61,4379	64,5098	73,7255	92,1568	98,3007	110,588	129,020
46	34,074	31,4016	41,8688	47,1024	52,3360	54,9528	62,8032	78,5040	83,7376	94,2047	109,906
41	30,370	27,9884	37,3178	41,9826	46,6473	48,9797	55,9768	69,971	74,6357	83,9651	97,9593
36	26,666	24,5752	32,7669	36,8627	40,9586	43,0065	49,1503	61,4379	65,5338	73,725	86,0131
33	24,444	22,5272	30,0363	33,7908	37,5454	39,4227	45,0545	56,3181	60,0726	67,5817	78,8453
30	22,222	20,4793	27,3057	30,7190	34,1322	35,8388	40,9586	51,1983	54,6115	61,4379	71,6776
27	20,000	18,4314	24,5752	27,6471	30,7190	32,2549	36,8627	46,0784	49,1503	55,2941	64,5098
18	13,333	12,2876	16,3834	18,4314	20,4793	21,5033	24,5752	30,7190	32,7669	36,8627	43,0065
15	11,111	10,2397	13,6529	15,3595	17,0661	17,9194	24,5752	25,5991	27,3057	30,7190	35,8388
12	8,888	8,1917	10,9223	12,2876	13,6529	14,3355	16,3834	20,4793	21,8446	24,5752	28,6710
9	6,666	6,1438	8,1917	9,2157	10,2397	10,7516	12,2876	15,3595	16,3834	18,4314	21,5033
6	4,444	4,0959	5,4611	6,1438	6,8264	7,1678	8,1917	10,2396	10,9223	12,2876	14,3355
4,5	3,333	3,0719	4,0959	4,6078	5,1198	5,3758	6,1438	7,6797	8,1917	9,2157	10,7516
3	2,222	2,0480	2,7306	3,0719	3,4132	3,5839	4,096	5,1198	5,4611	6,1438	7,1678
1,5	1,111	1,0240	1,3653	1,5359	1,7066	1,7919	2,048	2,5599	2,7306	3,0719	3,5839
NOTE 1: R_u stands for the useful bit rate (188 byte format) after MPEG-2 MUX. R_s (symbol rate) corresponds to the -3dB bandwidth of the modulated signal. $R_s(1 + \alpha)$ corresponds to the theoretical total signal bandwidth after the modulator.											
NOTE 2: 8PSK 8/9 is suitable for satellite transponders driven near saturation, while 16QAM 3/4 offers better spectrum efficiency for quasi-linear transponders, in FDMA configuration.											
NOTE 3: BW/R_s or BS/R_s ratios different from $1 + \alpha$ may be adopted for different service requirements. The adoption of BS/R_s figures significantly lower than $1 + \alpha$ (for example $BS/R_s = 1,21$ associated with $\alpha = 0,35$), to improve the spectrum exploitation, should be carefully studied on a case-by-case basis, since severe performance degradations may arise due to bandwidth limitations and/or adjacent channel interference, especially with 8PSK and 16QAM modulations and high coding rates (for example 5/6 or 7/8).											

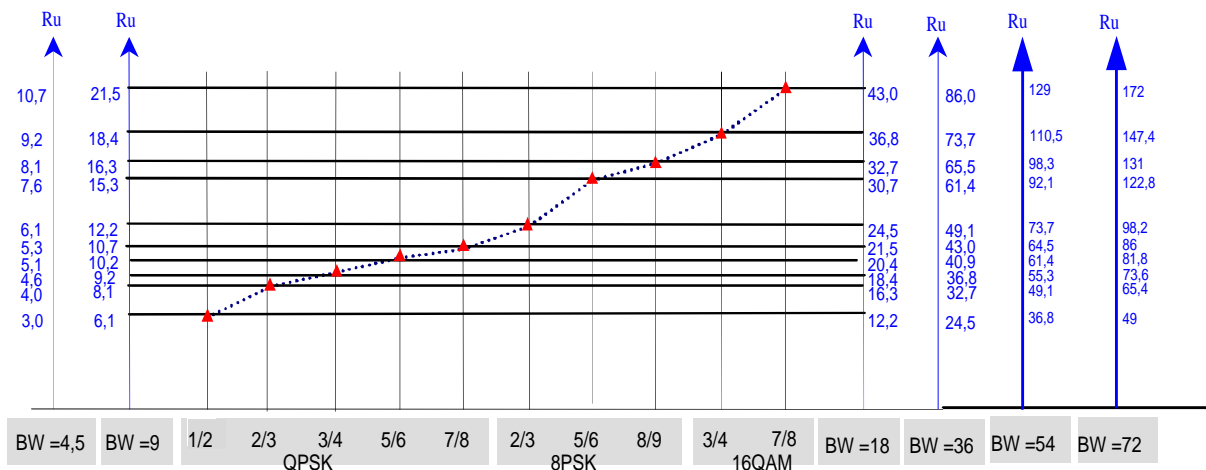

Figure 3a: Bit rate capacity versus available bandwidth (Ru in Mbit/s, and BW in MHz)

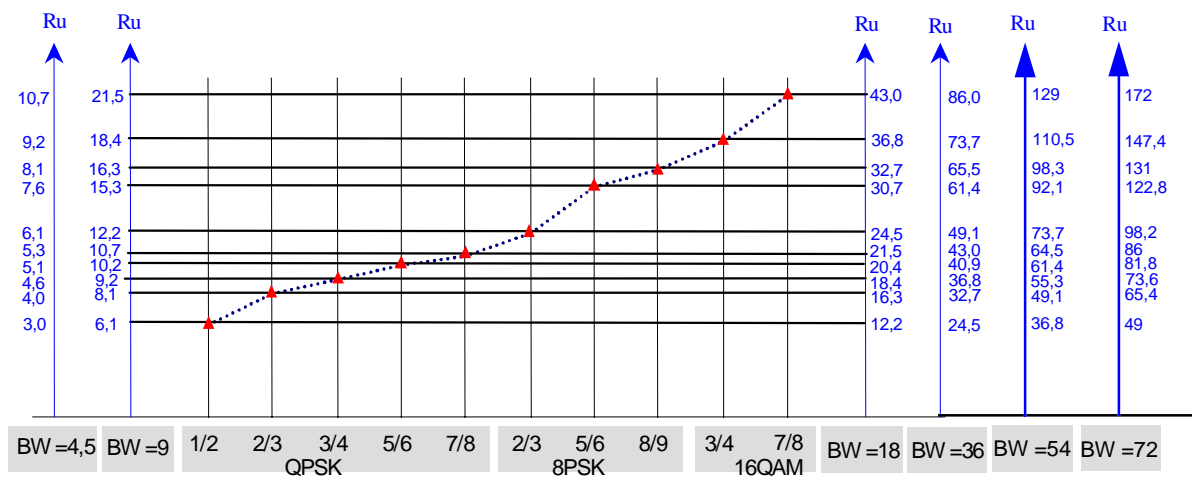

Figure 3b: Bit rate capacity versus available bandwidth (Ru in Mbit/s, and BW in MHz)

Single carrier per transponder is also possible mainly for contribution applications. Table 3 considers possible examples of use of the DSNG System in the single carrier per transponder configuration for 36 MHz and 27 MHz transponder bandwidth. Different modulation and inner code rates are given with the relevant bit rates. According to typical practical applications, a BW/R_s ratio equal to 1,31 is considered for 36 MHz and 1,23 for 27 MHz transponder bandwidth, offering a slightly better spectrum efficiency than the examples of table 2 for the same modulation/coding schemes. The considered transponder bandwidth of 27 MHz and 36 MHz is wide enough to allow high quality 422P@ML Single Channel Per Carrier (SCPC) transmissions, as well as MP@ML and 422P@ML Multiple Channels Per Carrier (MCPC) transmissions.

Table 3: Examples of System configurations by satellite: Single carrier per transponder

Satellite BW (At -3 dB)	System mode	Symbol Rate R_s [MBaud]	Bit Rate R_u (after MUX) [Mbit/s]	E_b/N_o (specification) [dB]
27	QPSK 5/6	22,000	33,791	6,0
36	QPSK 3/4	27,500	38,015	5,5
36	8PSK 2/3	27,500	50,686	6,9

NOTE 1: The E_b/N_o figures refer to the IF loop specification for Quasi-Error-Free (QEF) (see table 1). Overall linear, non-linear and interference performance degradations by satellite should be evaluated on a case-by-case basis; typical figures are of the order of 0,5 dB to 1,5 dB.

NOTE 2: Quasi-constant envelope modulations, such as QPSK and 8PSK, are power efficient in single carrier per transponder configuration, since they can operate on transponders driven near saturation. Conversely, 16QAM is not power efficient since it can only operate on quasi-linear transponders (i.e. with large Output-Back-Off, OBO). The use of the narrow roll-off $\alpha = 0,25$ with 8PSK can produce a larger non-linear degradation by satellite.

Table 4 considers possible examples of use of the DSN System in the multi-carrier FDM configuration and in SCPC (Single Channel Per Carrier) mode. Different modulation/coding modes are given with the relevant bit rates.

Table 4: Examples of System configurations by satellite: multi-carrier FDM transmissions, SCPC mode

Satellite BW [MHz]	Slot BS [MHz]	Number of Slots in BW	Video Coding	System mode	Symbol Rate [MBaud]	BS/ R_s [Hz/Baud]	Bit Rate R_u [Mbit/s]	E_b/N_o (specification) [dB]
36	9	4	MP@ML	QPSK 3/4	6,1113	1,47	8,4480	5,5
36	18	2	422P@ML	QPSK 7/8	13,3332	1,35	21,5030	6,4
36	12	3	422P@ML	8PSK 5/6	9,3332	1,28	21,5030	8,9
36	9	4	422P@ML	16QAM 7/8	6,6666	1,35	21,5030	10,7
72	18	4	422P@ML	QPSK 7/8	13,3332	1,35	21,5030	6,4

NOTE 1: The E_b/N_o figures refer to the IF loop specification for Quasi-Error-Free (QEF) (see table 1). Overall linear, non-linear and interference degradations by satellite should be evaluated on a case-by-case basis; typical figures are of the order of 0,5 dB to 1,5 dB.

NOTE 2: In the FDM configuration, the satellite transponder shall be quasi-linear (i.e. with large Output-Back-Off, OBO) to avoid excessive intermodulation interference between signals. Therefore 16QAM may be used.

4.4.1 Link budget - generic hypothesis

In order to illustrate some potential examples of the use of the system, link budget analysis have been carried out assuming the following hypothesis:

- It is considered a full 36 MHz transponder loaded with 4 equals digital carriers each one in a 9 MHz bandwidth slot.
- Following the examples given in figures 3a and 3b, it is considered a symbol rate of 6,66 MBaud in 9 MHz ($BW/R_s = 1,35$). In table 5 it is summarized the useful bit rate after MPEG-2 multiplex for each modulation and channel coding scenario.

Table 5

BW (MHz)	R_s (MBaud)	QPSK					8PSK			16QAM	
		rate 1/2	rate 2/3	rate 3/4	rate 5/6	rate 7/8	rate 2/3	rate 5/6	rate 8/9	rate 3/4	rate 7/8
		9	6,66	6,14	8,19	9,22	10,24	10,75	12,29	15,36	16,38

The following satellite TWTA overall operating points for each modulation and channel coding scheme, are considered (for multi-carrier per transponder operation) (see table 6).

Table 6

Modulation Scheme	IBO total (dB)	OBO total (dB)
QPSK and 8PSK	8	3,7
16QAM	10	6

Satellite resources per carrier: the percentage of the power consumption per carrier is the same as the percentage of bandwidth consumption per carrier:

- Power resources per carrier = 1/4 of the total power taking into account the overall operating point.
- Bandwidth resources per carrier = 1/4 of the total transponder bandwidth (i.e. 9 MHz).
- Quality and availability of the links: 2×10^{-4} before RS, 99,75 % and 99,9 % a.y. are considered (K and H ITU rain regions).

Transmit DSNG transportable earth station characteristics:

- Location: at beam edge and at beam centre.
- $\Phi = 0,9$ m, 1,2 m, 1,5 m and 1,8 m (65 % antenna efficiency, 0,3 dB coupling losses, 0,3 dB pointing losses) equipped with TWTA of 250 W.
- Maximum operational EIRP (for 3 dB OBO) = 67 dBW for 1,8 m, 65 dBW for 1,5 m, 63 dBW for 1,2 m and 60 dBW for 0,9 m).

Receive earth station characteristics for DSNG transmissions:

- Location: at beam edge and at beam centre.
- $\Phi = 2,4$ m (G/T = 25 dB/k); 4,5 m (G/T = 30 dB/k) and 8,1 m (G/T = 35 dB/k).
- 65 % antenna efficiency, 0,3 dB coupling losses, 0,5 dB pointing losses, 1,2 dB noise figure.

Earth station characteristics for fixed contribution links:

- $\Phi = 8,1$ m, 4,5 m and 2,4 m.
- Total (TWTA) OBO = 2 dB for QPSK and 8PSK, and 6 dB for 16QAM.
- Maximum operational EIRP = ≤ 80 dBW.
- G/T = 35 dB/k for 8,1 m, 30 dB/k for 4,5 m and 27 dB/k for 2,4 m.

Satellite characteristics:

- G/T = 5,5 dB/K at beam centre (-0,5 dB/K at beam edge).
- EIRP (at saturation) = 50 dBW at beam centre (42 dBW at beam edge).

IPFD = -85,5 dBW/m² (Nominal setting) at beam centre (-79,5 dBW/m² at beam edge). For the fixed contribution links using (16QAM) it is considered the operation of the transponder in 3 dB lower gain conditions.

Simplified link budgets considering a total degradation of 2 dB due to all sources of interference (crosspolar and adjacent channels, intermodulation, non linearities, etc.)

Other assumptions are:

- Reference satellite orbital location: 0°E.
- Uplink frequency: 14,25 GHz.
- Downlink frequency: 11,75 GHz.
- Sea level height for the transmit and receive earth stations: 100 m.
- Atmospheric absorption: (0,3 dB for uplink and 0,2 dB for the downlink).
- Worst case polarization (Linear horizontal).

4.4.2 DSNG Examples

Figures 4, 5, 6, 7, 8, 9 and 10, summarize the results in terms of clear sky margins obtained for the DSNG links using the above hypothesis.

Figures 4, 6 and 9 include the results for the beam edge to beam edge links and figures 5, 7, 8 and 10 are for the beam centre to beam centre links.

In these graphics it is indicated as reference, the estimated margin required for the 99,9 % and 99,75 % link availability corresponding to the ITU rain regions K and H.

For example, if the required availability is 99,9 % and the transmission is made from zone H using 1,8 m as transportable earth station (maximum EIRP of 67 dBW), and 8,1 m as receiving earth station, both located at beam edge, it is possible to transmit a maximum useful data rate of about 12,29 Mbit/s in a 9 MHz slot using 8PSK 2/3 modulation scheme (see figure 4). In the same conditions of availability, zone and receiving earth station, if the transmit earth station is 1,2 m (maximum EIRP of 63 dBW), the maximum useful data rate is 9,22 Mbit/s in a 9 MHz slot using QPSK 3/4 modulation scheme.

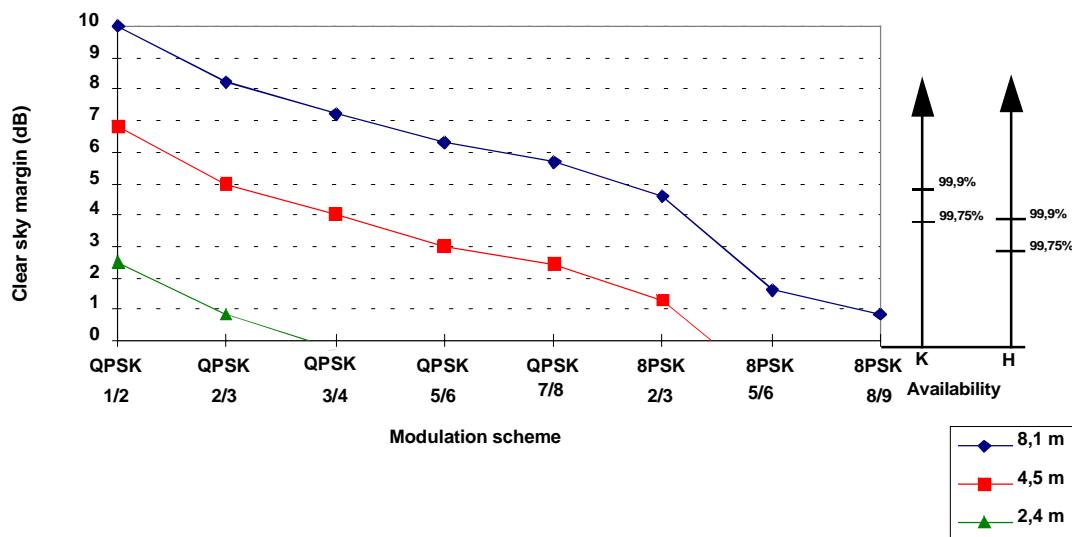

Figure 4: Clear sky margins for DSNG links (beam edge-to-beam edge), using transportable terminals of 1,8 m (useful EIRP 67 dBW) for different receiving earth stations (8,1 m, 4,5 m, 2,4 m)

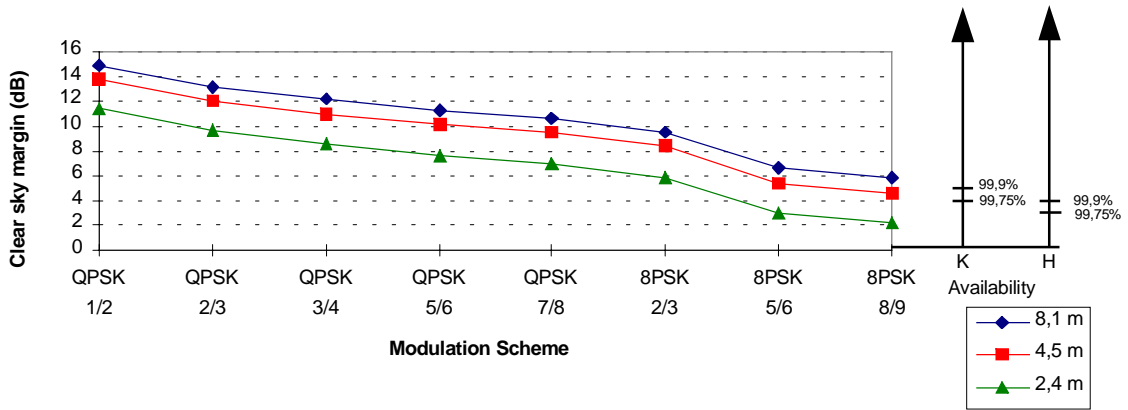

Figure 5: Clear sky margins for DSNG links (beam centre-to-beam centre), using transportable terminals of 1,8 m (useful EIRP 67 dBW) for different receiving earth stations (8,1 m, 4,5 m, 2,4 m)

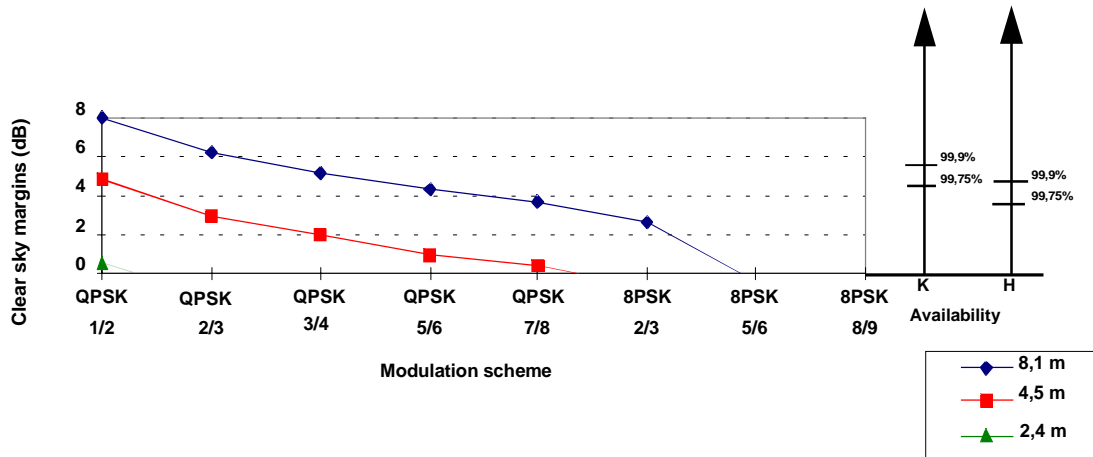

Figure 6: Clear sky margins for DSNG links (beam edge-to-beam edge), using transportable terminals of 1,5 m (useful EIRP 65 dBW) for different receiving earth stations (8,1 m, 4,5 m, 2,4 m)

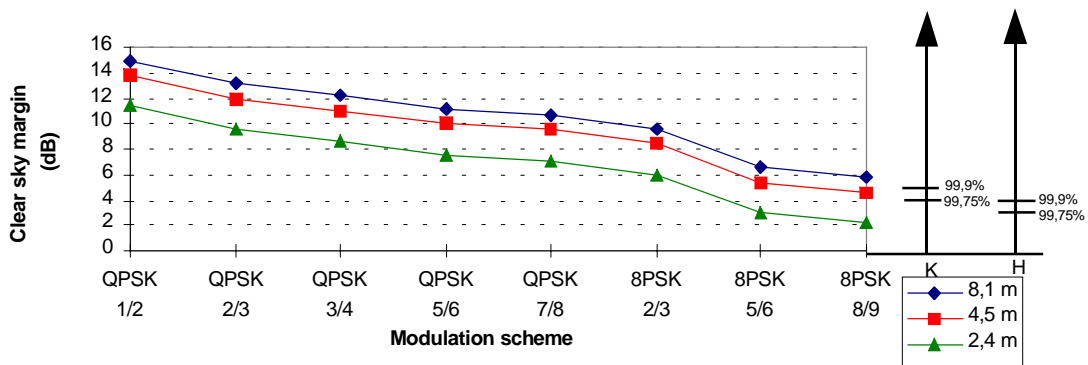

Figure 7: Clear sky margins for DSNG links (beam centre-to-beam centre), using transportable terminals of 1,5 m (useful EIRP 65 dBW) for different receiving earth stations (8,1 m, 4,5 m, 2,4 m)

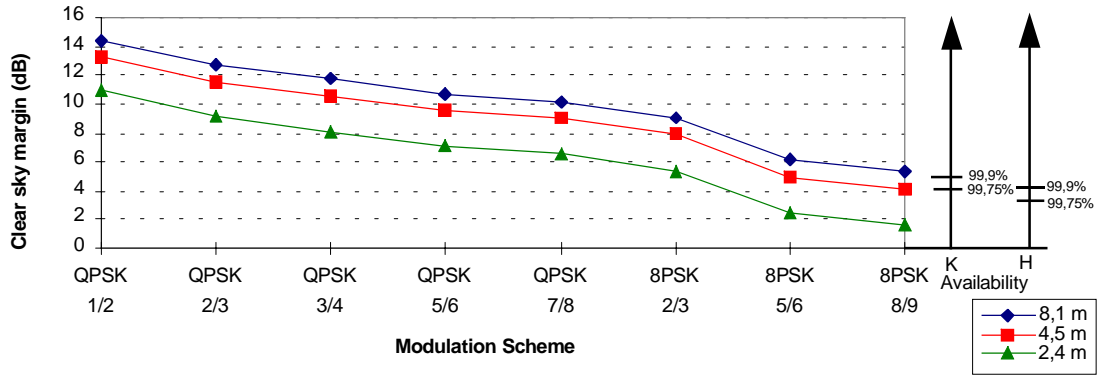

Figure 8: Clear sky margins for DSNG links (beam centre-to-beam centre), using transportable terminals of 1,2 m (useful EIRP 63 dBW) for different receiving earth stations (8,1 m, 4,5 m, 2,4 m)

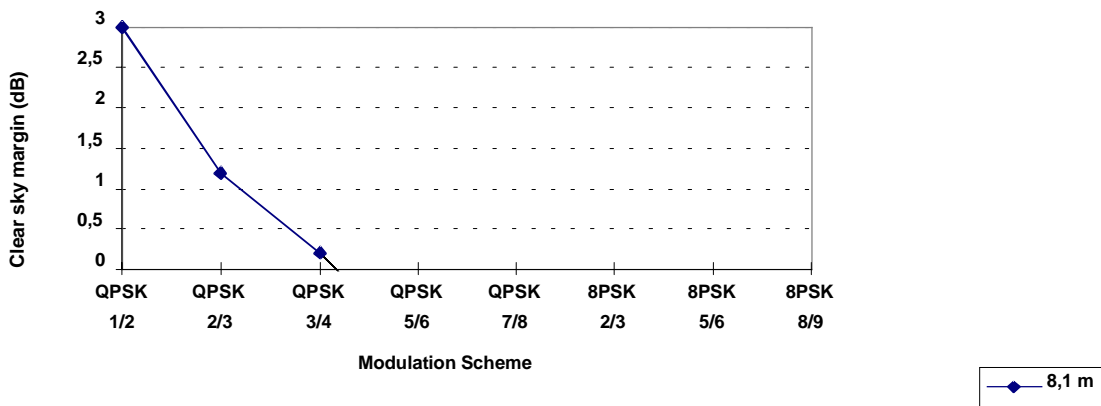

Figure 9: Clear sky margins for DSNG links (beam edge-to-beam edge), using transportable terminals of 0,9 m (useful EIRP 60 dBW) for different receiving earth stations (8,1 m, 4,5 m, 2,4 m)

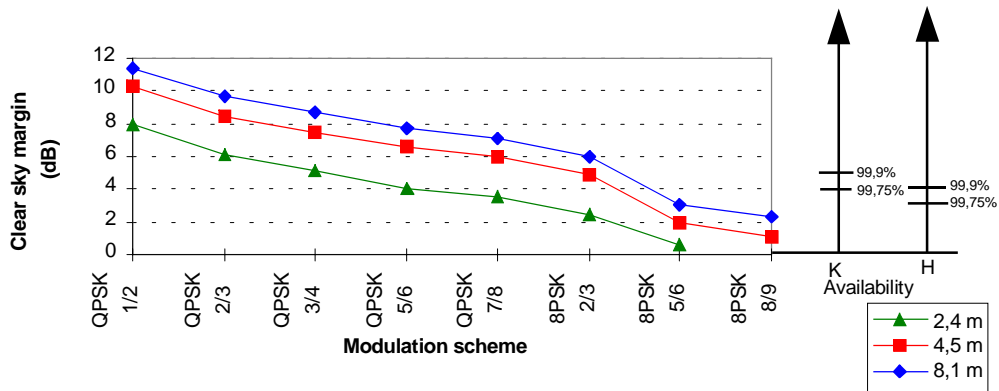

Figure 10: Clear sky margins for DSNG links (beam centre-to-beam centre), using transportable terminals of 0,9 m (useful EIRP 60 dBW) for different receiving earth stations (8,1 m, 4,5 m, 2,4 m)

The results included in the figures can be extrapolated for different symbol rates considering their corresponding satellite power and bandwidth resources scaled in a proportional way.

For example the clear sky margins included in figure 4 can be considered as the clear sky margins obtained by the links made using 1,5 m transportable DSNG (65 dBW as maximum EIRP) for a symbol rate of 3,33 MBaud in 4,5 MHz bandwidth slot. An other example, the clear sky margins included in figure 6 are also applicable to 1,8 m as transportable terminal (67 dBW as maximum EIRP), considering 13,3 MBaud in 18 MHz bandwidth.

4.4.3 Fixed contribution links

Figures 11 and 12 summarize the results in terms of clear sky margins obtained for fixed contribution links using the corresponding hypothesis (see subclause 4.4.1).

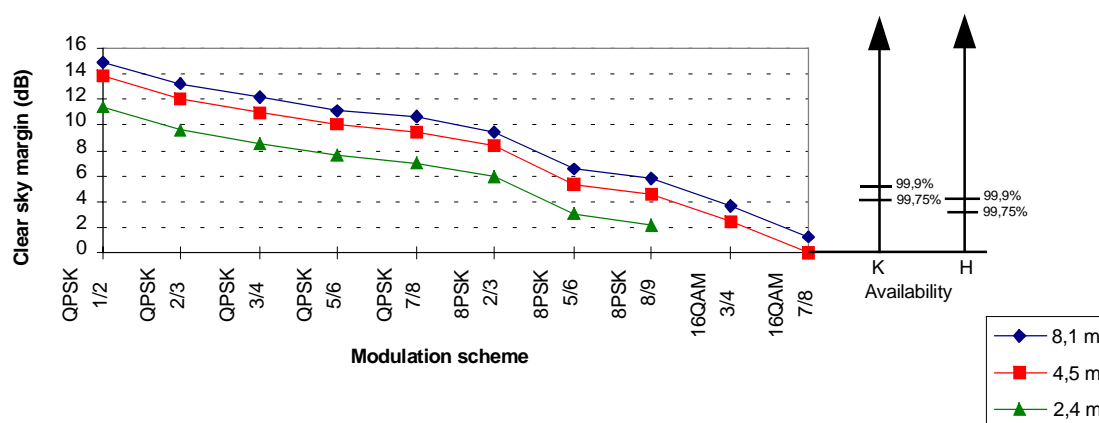

Figure 11: Clear sky margins for fixed contribution links considering different receiving earth stations (8,1 m, 4,5 m and 2,4 m) located at beam centre (Transponder operated in "Nominal Gain")

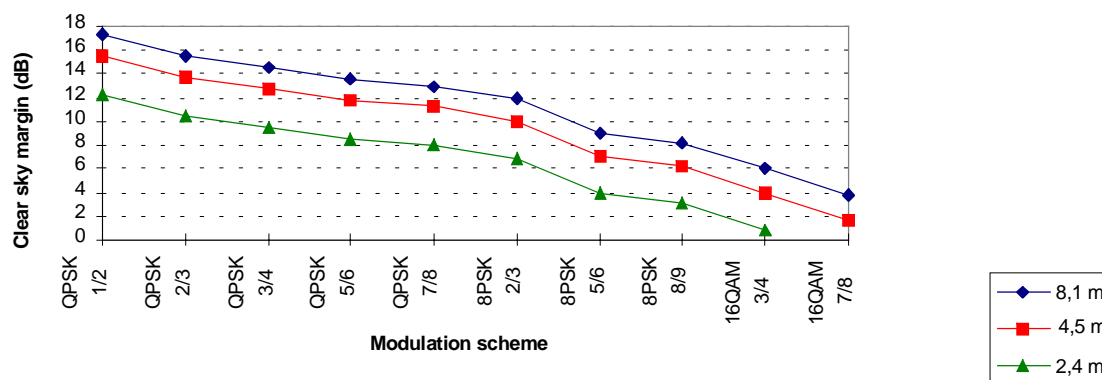

Figure 12: Clear sky margins for fixed contribution links considering different receiving earth stations (8,1 m, 4,5 m and 2,4 m) located at beam centre (Transponder operated in "Nominal Gain-3 dB")

4.4.4 Interfacing with terrestrial telecommunications networks

There is the possibility within the specified system to allow interworking between satellite and terrestrial digital networks.

The connection of the system with the terrestrial telecommunications networks is illustrated in figure 13. Table 7 shows the symbol rates and their corresponding bandwidth that would be suitable for connection to a PDH terrestrial networks at 34 368 Kbit/s, where the transmission capacity is 29 140 Kbit/s after Reed Solomon coding.

Table 7: Examples of Symbol rates using QPSK, 8PSK and 16QAM for 29,140 Mbit/s bit rate after RS

	QPSK					8PSK (Optional)			16QAM (Optional)	
	1/2	2/3	3/4	5/6	7/8	2/3	5/6	8/9	3/4	7/8
Rs (MBaud)	29,14	21,86	19,43	17,48	16,65	10,93	8,74	8,20	4,86	4,16
BW = Rs x 1,35 (Rs x 1,25 Optional) (MHz)	39,34	29,50	26,23	23,60	22,48	14,75 (13,66)	11,80 (10,93)	11,06 (10,25)	6,56 (6,08)	5,62 (5,20)

In order to provide an example of the system for connection to a PDH terrestrial networks, it is considered a 72 MHz transponder divided into four 18 MHz slots. The following configuration is suitable for this application:

- Useful bit rate (R_u) + Reed Solomon bit rate (RS) = 29,140 Mbit/s.
- Modulation scheme: 8PSK.
- Convolutional coding 2/3.
- Symbol Rate (R_s) = 10,928 MBaud.
- Allocated bandwidth ($R_s \times 1,35$) = 14,8 MHz (compatible with 18 MHz bandwidth slot).
- Fixed contribution link between 8,1 m earth stations, located at beam center for 99,9 % availability (zone K).

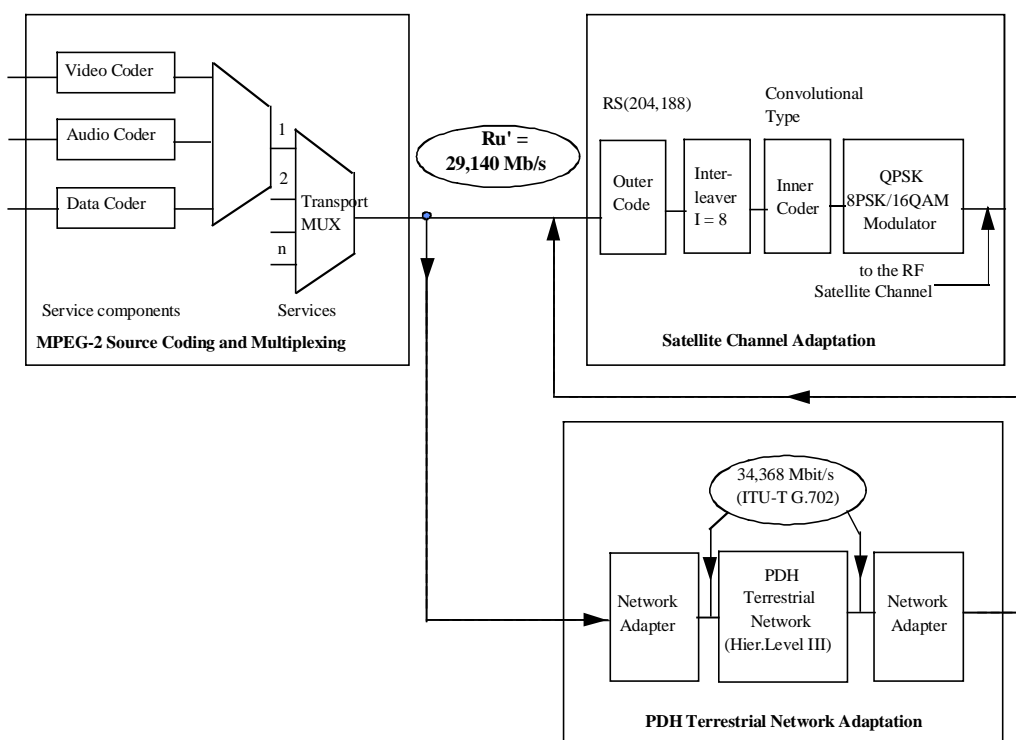

Figure 13: Example of Connection of the System with Terrestrial PDH Network following ETS 300 813 [12]

5 Analysis of the co-ordination channels capabilities

5.1 Summary of the co-ordination channel system

Following the ITU-R Recommendation SNG.771-1 [19] "SNG earth stations should be equipped to provide two-way satellite communication circuits which shall be available prior to, during and after, the transmission of the vision and associated sound or sound programme signal. These circuits will provide communications between the SNG operator, the satellite operator and the broadcaster; that two or more duplex circuits should be provided, whenever possible within the same transponder as the programme vision and associated sound or sound programme signal". The same Recommendation considers "that throughout the world, where news events take place, uniform technical and operational standards for communication should be established to ensure prompt activation of the SNG service".

The availability of co-ordination (communication) circuits by satellite may be particularly useful in areas where access to the public switched or cellular telephone networks is difficult or impossible. For these purposes, the same antennas of the DSNG stations may often be used, and the same frequency resources (or at least the same satellite transponder) as the main DSNG signal may be exploited. Other frequency resources may also be chosen according to the operational conditions and requirements.

To achieve a two-way (i.e. full-duplex) communication channel, two independent carriers have to be transmitted, one from the DSNG terminal, the other from a fixed station. Depending on the service requirements, various scenarios are possible, some of which require reduced communication capacity, others are more demanding (in terms of the number of required connections and up-link facilities). Figure 14 extracted from EN 301 222 [2], shows two examples of implementation of the co-ordination channels between the DSNG terminal, the broadcaster, the DSNG operator (when required) and the satellite operator:

- Scenario A (two up-links for co-ordination carriers): the DSNG terminal and a central station (for example the broadcaster's fixed station) up-link a single co-ordination carrier each, containing U multiplexed circuits. In this scenario the terrestrial infrastructure (for example PSTN) is used to forward the co-ordination circuits from the central station to the DSNG operator and the satellite operator and the co-ordination equipment at the DSNG terminal has to transmit and receive a single co-ordination carrier.
- Scenario B (four up-links for co-ordination carriers): the DSNG terminal up-links a single co-ordination carrier, containing three multiplexed channels ($U = 3$), while the broadcaster, the DSNG operator and the satellite operator up-link a total of three co-ordination carriers, each with a single circuit. In this scenario, the co-ordination equipment at the DSNG terminal has to transmit a single co-ordination carrier, and to receive three carriers at the same time.

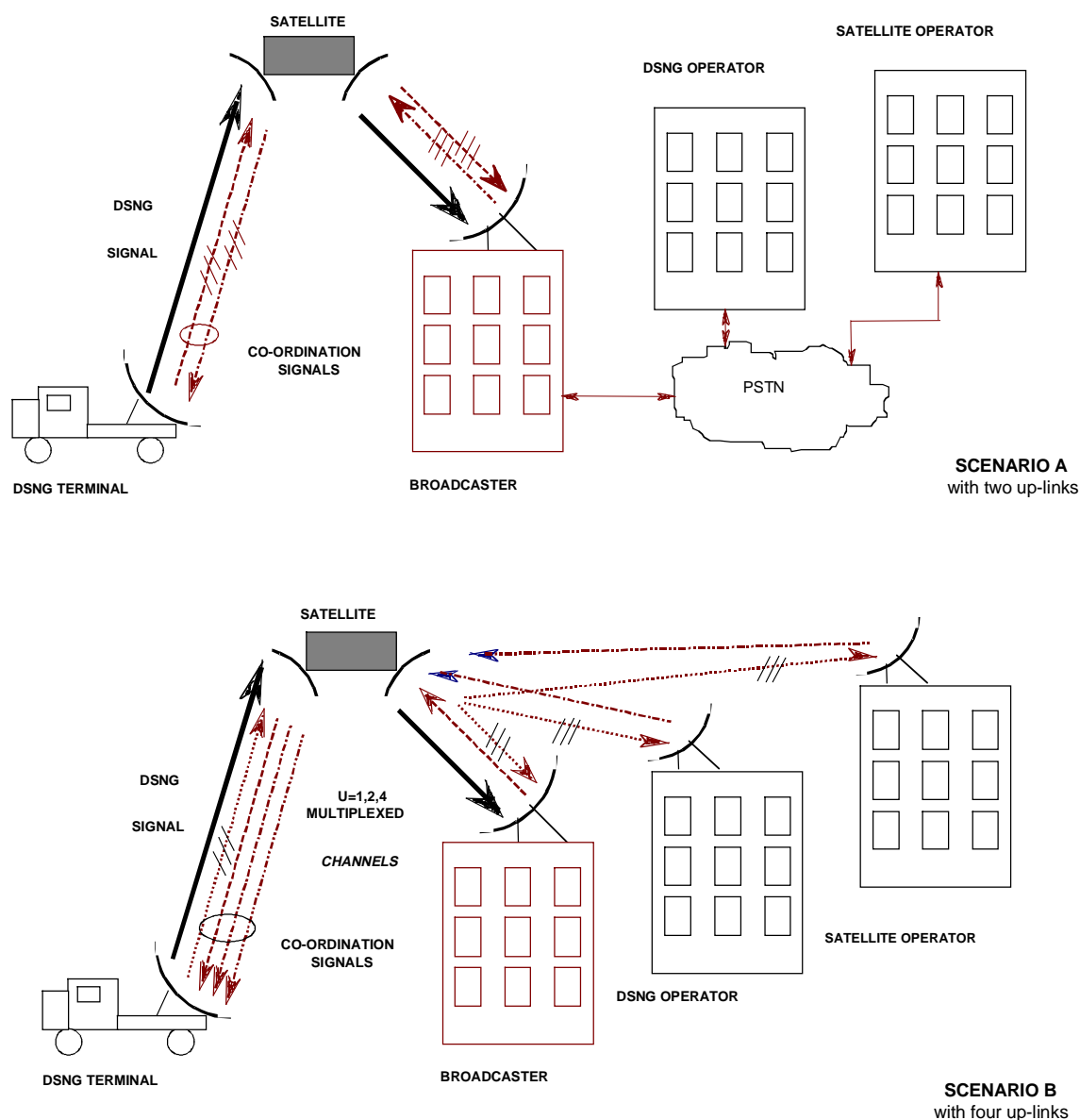

Figure 14: Example environments for DSNG and co-ordination channels transmissions by satellite

Co-ordination channels services: voice, fax and data

The co-ordination channels specification describes the source coding (for voice and data), multiplexing, channel coding and modulation system for the optional co-ordination (communication) channels by satellite associated with DSNG services. The integration of this System in a DSNG station shall be optional, since other communication systems (for example PSTN, cellular phones connected to terrestrial or satellite networks) may be used, according to the prevailing operational needs.

Maximum compatibility with existing ETSI and ITU standards is maintained. In particular voice coding is performed according ITU-T Recommendation G.729 [24] (see Informative Note), offering high voice quality at 8 kbit/s (i.e. better than ADPCM at 32 kbit/s).

Data transmission is performed in synchronous RS-422 format, (ITU-T Recommendation V.11 [25]) at bit-rates of 8 kbit/s, 16 kbit/s, or 32 kbit/s. Optionally it may be performed in asynchronous RS-232 format (ANSI/EIA RS232E [26]) at a maximum bit-rate of 9,6 kbit/s, 19,2 kbit/s or 38,4 kbit/s.

The co-ordination channels system provides up to four full-duplex co-ordination (voice) channels at 8 kbit/s by satellite, or data capacity for other applications. A co-ordination channel may also convey facsimiles (fax). A fixed time-division multiplex allows the transmission of one, two or four 8 kbit/s channels producing an output bit-stream at 8,16 kbit/s, $2 \times 8,16$ kbit/s, $4 \times 8,16$ kbit/s, respectively. The multiplex provides a signalling byte, which indicates the multiplex configuration to the receiver.

Modulation and channel coding

In order to achieve high ruggedness against noise and interference Direct-Sequence Spread-Spectrum (DS-SS) processing is applied before Quaternary Phase Shift Keying (QPSK) modulation, generating a modulated signal whose bandwidth occupation is expanded and whose power spectral density level is reduced accordingly. DS-SS technique permits the superposition of a number of co-ordination signals in the frequency domain (Code Division Multiple Access, CDMA), using the same centre frequency. For example the scenarios in figure 14 may be efficiently implemented by using this technique.

For system simplicity, the spreading processes are asynchronous at each terminal, therefore the number of channels which may be superimposed is limited by mutual interference. Compared to conventional modulations, DS-SS techniques offer significant performance improvements in the presence of interference (for example from and to co-channel narrow-band signals) and also produce less intermodulation noise density over a non linear transponder. DS-SS signals also require less frequency precision in the transmission/reception equipment. In figure 15 the basic principle of Direct-Sequence Spread-Spectrum coding is illustrated.

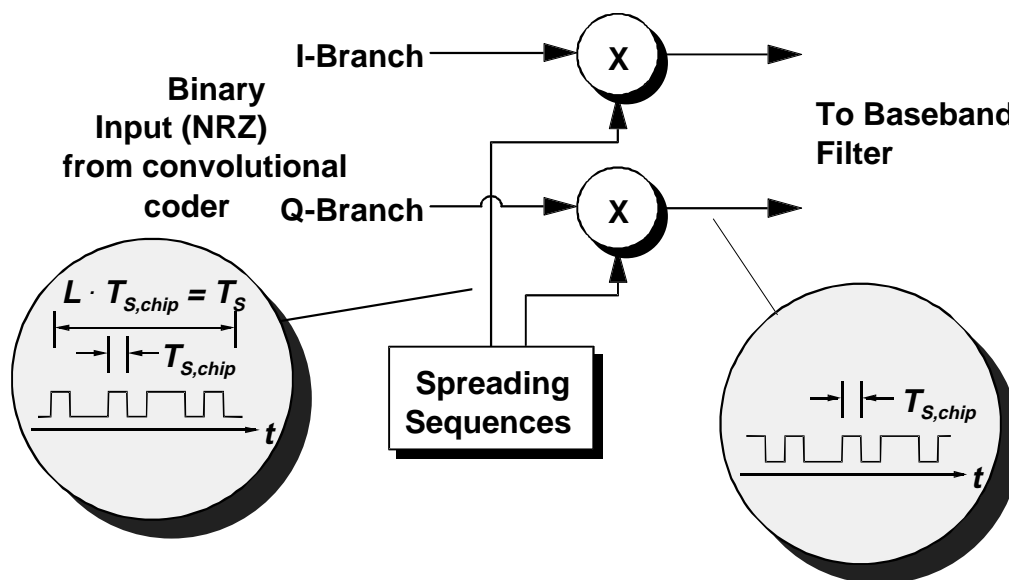

Figure 15: Basic principle of Direct-Sequence Spread-Spectrum coding

The bit stream randomization for energy dispersal and inner convolutional coding (rate 1/2 only) for error correction is also considered in order to achieve high ruggedness against noise and interference. Reed-Solomon coding and convolutional interleaving are not used in the System, as the target BER (10^{-3}) after FEC decoding is adequate for voice communication using ITU-T Recommendation G.729 [24], and additionally since they would generally introduce a large end-to-end delay which may cause problems on voice communications in DSNG applications.

In summary, the following processes are applied to the data stream (see figure 16):

- Voice coding at 8 kbit/s according to ITU-T Recommendation G.729 [24].
- Data coding (Optional).
- Multiplexing and framing.
- Multiplex adaptation and signal randomization for energy dispersal.
- Rate 1/2 convolutional inner coding with constraint length 7, according to EN 300 421 [5].

- Direct-Sequence Spread-Spectrum (DS-SS) processing (with five possible spreading factors: $L = 31, 63, 127, 255$ and 511).
- Bit mapping into QPSK constellation, according to EN 300 421 [5].
- Square-root raised cosine baseband shaping (roll-off factor $\alpha = 0,35$), according to EN 300 421 [5].
- Quadrature modulation, according to EN 300 421 [5].

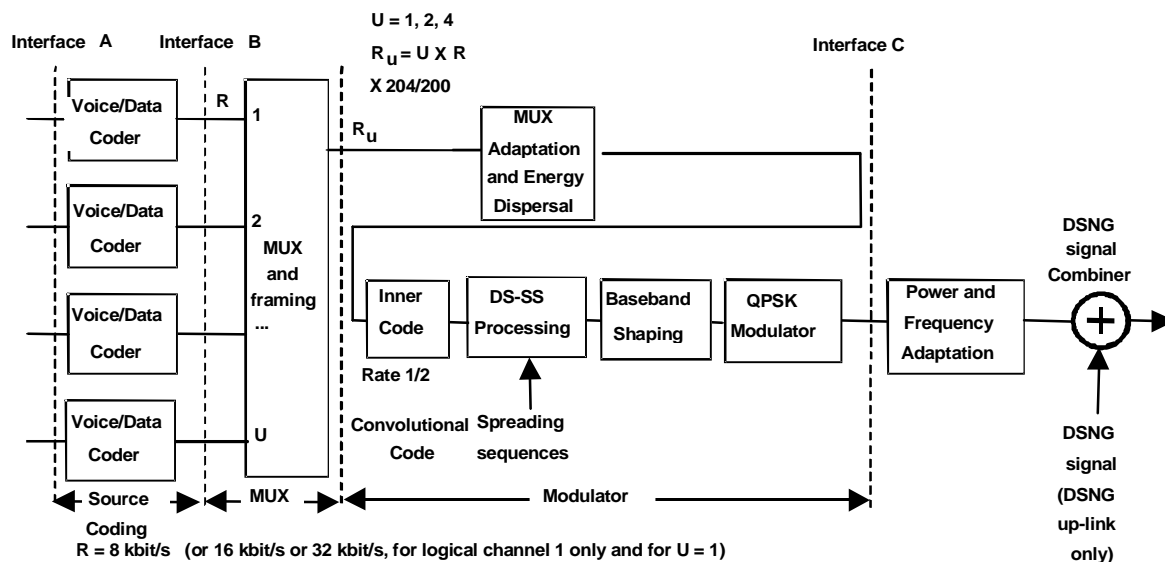

Figure 16: Functional block diagram of the System

Flexible user definable set-up configuration

The co-ordination carriers may be transmitted at a power level significantly lower than that of the DSNG carrier, since their bit-rate is typically some hundred times lower than the DSNG bit-rate, therefore they do not significantly modify the transponder operating point.

Flexible, user-definable frequency assignments may be used for the co-ordination channels, allowing the selection on a case-by-case basis of the best Frequency Division Multiplex (FDM) configuration in the satellite transponder. For example, the System is capable of operating, if required, within the same frequency slot as the main DSNG signal, while keeping the level of mutual interference between the main DSNG signal and the co-ordination carriers at an acceptable level. Annex D of EN 301 222 [2] includes further details and is here reproduced in subclause 5.2. To achieve this, the co-ordination channels may be superimposed onto the main DSNG signal (for example the same centre frequency), at the cost of some performance degradation due to mutual interference, which may be more or less critical depending on the modulation/coding scheme of the DSNG system and on the mutual signal levels. As an alternative, the co-ordination channels using a low spreading factor (for example 0,5 MHz or 1 MHz bandwidth occupation) may be allocated within the "roll-off" region of the DSNG signal, in order to reduce the mutual interference between co-ordination and DSNG signals. In other cases, a clear frequency slot may be allocated to co-ordination channels, on the same transponder as the DSNG signal, or even on another transponder/satellite, according to the service requirements.

The transmission parameters of the co-ordination channels, such as the frequency, the power level, the symbol-rate and the spreading sequences shall be selectable by the operator in order to allow flexible access to the satellite resources. They are to be manually set-up in the co-ordination terminals.

At least one user definable frequency and power set-up configuration shall be provided by the co-ordination channel equipment, in order to facilitate rapid link set-up in emergency situations (see annex B of EN 301 222 [2]). This frequency and power set-up shall be easily selectable in the equipment.

Normal practice for setting up the co-ordination carriers will be defined from operational experience of the system.

Error Performance

The modem, connected in IF loop, shall meet the BER versus E_b/N_0 performance requirements given in table 8.

Table 8: IF-Loop performance for the co-ordination channels system

Modulation	Convolutional code rate	Spectral efficiency before spreading (bit/symbol)	Required E_b/N_0 (dB) (Note) for BER = 10^{-3}
QPSK	1/2	0,9804	3,6
NOTE: The figure of E_b/N_0 is referred to the bit-rate after Viterbi decoding (i.e. R_u) and includes a modem implementation margin of 0,8 dB.			

BER levels up to 10^{-3} may be tolerated by voice services. Lower BER levels may be required for some data services, in this case additional error protection may be applied externally to the modem.

5.2 Examples of use of the DVB-DSNG System with their associated co-ordination channels

This subclause has been extracted from annex D of document EN 301 222 [2].

A DSNG transmission may consist of the main DSNG signal, compliant with the DSNG specification EN 301 210 [1] plus various co-ordination signals (full-duplex links). Different frequency allocations may be adopted for the co-ordination channels, depending on the available bandwidth, spectrum occupation of the main DSNG transmission, number of co-ordination channels, and other service requirements. The co-ordination signals may be placed in a clear frequency slot of the transponder, and in this case no co-channel interference to and from the DSNG signal is present, but only the mutual interference among the co-ordination channels (in addition to the typical interference in the transponder). As an alternative, the co-ordination carriers can share the same frequency slot (bandwidth BS) as the DSNG signal, accepting some performance degradation for both the co-ordination signals and the DSNG signal. In this latter case (see figure 17), the co-ordination signals may be superimposed onto the DSNG signal or may be placed in its roll-off region, in order to reduce the mutual interference. The superimposed configuration may have the operational advantage to use the same centre frequency for the DSNG carrier ($f_{0,DSNG}$) as for the co-ordination carriers ($f_{0,COOR}$), while the roll-off configuration may have the advantage to reduce the mutual interference between the DSNG and co-ordination signals, thus allowing better RF performance.

The co-ordination channels sharing the same DSNG frequency slot may use different bit-rates, spreading sequences and spectral density levels, according to the operational requirements. Nevertheless the number of co-ordination channels should be maintained as low as the operational requirements permit, in order to limit the mutual DSNG/co-ordination channels interference. Furthermore to guarantee an adequate mutual signal to interference ratio due to the other co-ordination channels, the different co-ordination channels should be kept at the same power spectral density level.

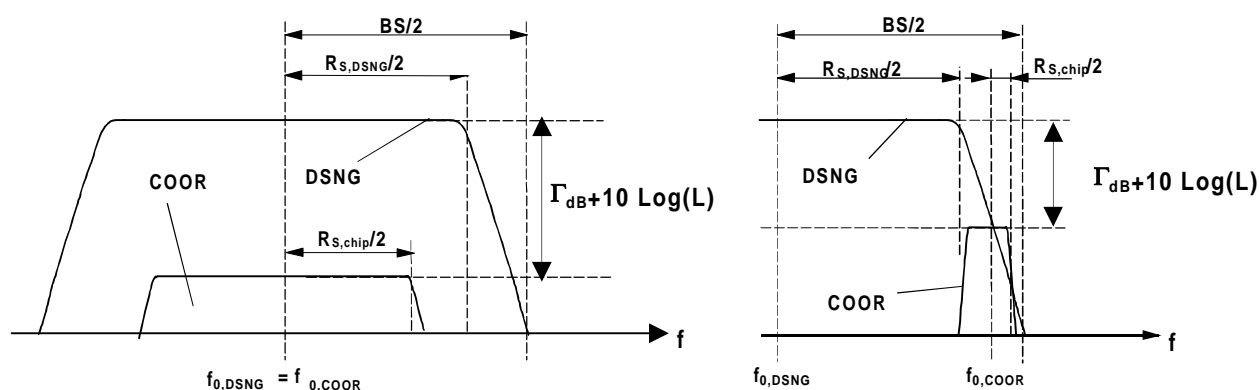

NOTE: The E_b/N_0 ratios displayed by demodulators are usually evaluated from BER measurements. Therefore they refer to an effective $E_b/(N_0 + I_0)$ ratio, where I_0 is the equivalent spectral density of the interfering signals (for example, the co-ordination channels) and N_0 the spectral density of the thermal noise. As a consequence, in the presence of co-ordination channel interference, care should be taken by the operators while evaluating the real thermal noise margin and allowed rain attenuation of the link.

Figure 17: Possible frequency allocations of the co-ordination signals in the DSNG frequency slot: (left) superimposed to the DSNG signal; (right) in the roll-off region of the DSNG signal

To estimate, to a first approximation, the impact of the co-ordination channels on the DSNG signal performance, the following hypotheses have been adopted: (a) the transponder is operated in a quasi linear mode; (b) the interference of the DSNG signal on the co-ordination channels (and vice-versa) and the co-ordination channel interference due to the other co-ordination channels is equivalent to Gaussian noise of the same power. The latter approximation may be slightly pessimistic compared to digitally modulated signals, and applies under the assumption of non-synchronized and therefore non-orthogonal spreading sequences. In this case the co-ordination channel signal to interference ratio due to the other co-ordination channels can be approximated by the power ratio $L/(M-1)$, where L indicates the spreading factor and M the number of co-ordination carriers in CDMA. (When the co-ordination channels are synchronized, the signal to interference power ratio can be approximated by the ratio $L^2/(M-1)$). The E_b/N_0 performance degradation of the main DSNG signal Δ_{DSNG} , due to the co-ordination channel interference, can be computed with the formulae:

$$\Delta_{DSNG} = \rho_{DSNG} / (\rho_{DSNG} - 1)$$

$$\rho_{DSNG} = R_{DSNG} A^2 / (M R_{COOR} (E_b/N_0)_{COOR} (E_b/N_0)_{DSNG} \rho_{COOR} \eta_{DSNG}^2)$$

$$\rho_{COOR}^{-1} = 1 - \Delta_{COOR}^{-1} - ((L/(M-1)) / (E_b/N_0)_{COOR})^{-1}$$

where M indicates the number of communication carriers ($M = 2$ corresponds to a single full-duplex connection), R_{DSNG} and R_{COOR} the useful bit-rate for the main and co-ordination signals respectively, η_{DSNG} the modulation/coding spectral efficiency (bit/symbol) of the DSNG signal, Δ_{COOR} the E_b/N_0 performance degradation of the co-ordination signal, ρ is a parameter related to the ratio between C/N and C/I . A is the mutual interference power suppression of the DSNG and each co-ordination channel due to the baseband filtering in transmitters and receivers, assuming matched filters ($A = 1$ for co-ordination signals superimposed onto the DSNG signal). The factor A may be computed by using the formula:

$$A = \frac{1}{R_{S,COOR}} \int_{-\infty}^{\infty} H_{DSNG}^2(f) H_{COOR}^2[f - (f_{0,DSNG} - f_{0,COOR})] df$$

where H_{DSNG} is the transfer function of the DSNG receive/transmit baseband filters and H_{COOR} is the transfer function of the co-ordination receive/transmit baseband filters (ideally corresponding to square root raised cosines).

Given the previously defined E_b/N_0 performance degradation of the co-ordination signal Δ_{COOR} , and therefore the factor ρ_{COOR} , the ratio Γ between the spectral densities of the DSNG signal and of each co-ordination signal divided by the spreading factor L can be estimated as:

$$\Gamma = A / ((E_b/N_0)_{COOR} \rho_{COOR} \eta_{COOR}) \quad \text{where: } \eta_{COOR} = 0,9804$$

Table 9 reports a list of the symbols and their meanings.

Table 9: List of the symbols

A	Interference suppression in the baseband filters
Δ	E_b/N_0 degradation at the target BER
E_b/N_0	Ratio between the energy per useful bit and twice the two side thermal noise power spectral density
Γ	Ratio of the spectrum density of the DSNG signal and of each co-ordination signal divided by the spreading factor L
η	Modulation/coding spectral efficiency (bits per transmitted symbol)
L	Spreading sequence length (Spreading Factor) (bit)
M	Number of co-ordination carriers transmitted in CDMA configuration
R	Useful bit-rate before multiplexer
ρ	Parameter related to the ratio between C/N and C/I

NOTE 1: The sub-script COOR refers to the co-ordination signals.

NOTE 2: The sub-script DSNG refers to the main DSNG signal.

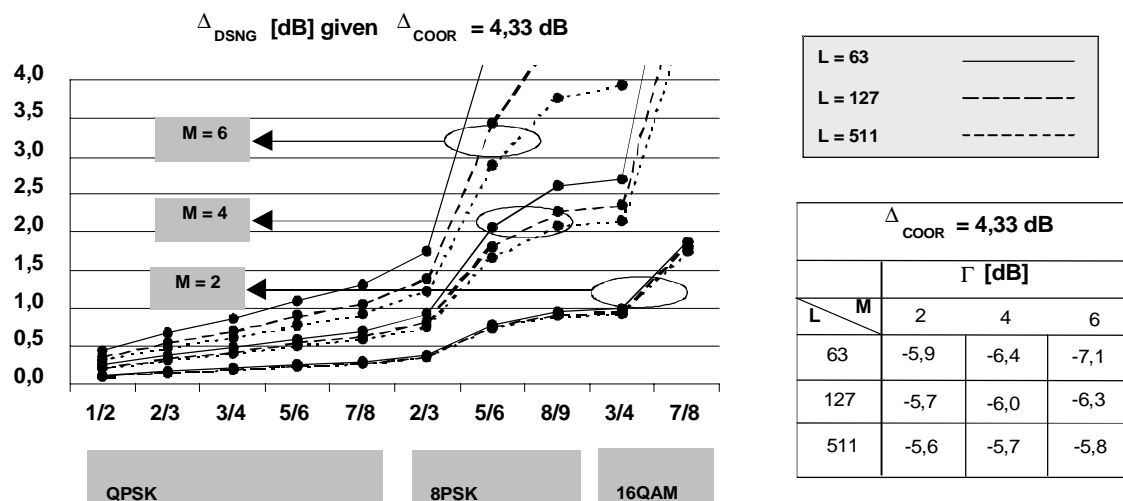

Figure 18

Assuming superimposed frequency sharing as in figures 17 (left), 18 and 19 give examples of the main DSNG signal E_b/N_0 performance degradation Δ_{DSNG} . The main DSNG signal has a symbol rate of 6,666 MBaud, thus occupying a frequency slot of 9 MHz. A fixed degradation of the co-ordination channel performance of 4,33 dB (see note 3) has been imposed, due to interference from the DSNG signal and from other co-ordination channels. The required $(E_b/N_0)_{\text{COOR}}$ is 3,6 dB at a target BER of 10^{-3} (see table 7). The DSNG schemes considered are QPSK, 8PSK, 16QAM, assuming the IF-loop performance given in table 1. In figures 18 and 19, the adopted Γ factor is also given, representing the ratio between the DSNG and co-ordination channel spectral density divided by the spreading factor L. Other Γ factors may be chosen, according to the performance requirements. Lower Γ figures improve the performance of the co-ordination channels, while larger Γ figures improve the DSNG performance.

NOTE 3: This corresponds to a fixed BER of about 10^{-5} after Viterbi decoder in the absence of thermal noise.

EXAMPLE 1: (Figure 18) 8 kbit/s per co-ordination carrier, different number of unidirectional channels M.

Figure 18: 8 kbit/s co-ordination channels superimposed to DSNG. Example performance degradation of DSNG ($R_S = 6,666$ MBaud) interfered with by M co-ordination signals, with L = 63, L = 127 and L = 511. The degradation of the co-ordination channels has been assumed to be $\Delta_{\text{COOR}} = 4,33$ dB. Table 9 reports the meaning of the symbols.

Assuming a DSNG signal using QPSK FEC rate 2/3, from figure 18 (8 kbit/s channels) an estimated DSNG degradation of 0,7 dB is obtained for M = 6 and L = 63. For higher DSNG spectrum efficiency modes (for example 8PSK and 16QAM), the interference degradation progressively increases and may become unpractical.

EXAMPLE 2: (Figure 19) 32 kbit/s per co-ordination carrier, different number of unidirectional channels M.

For 32 kbit/s co-ordination channels and M = 2, a degradation on the DSNG signal (QPSK 1/2, 2/3 and 3/4) lower than 1 dB is achieved.

Figure 19: 32 kbit/s co-ordination channels superimposed to DSNG. Example performance degradation of DSNG ($R_S = 6,666$ MBaud) interfered with by M co-ordination signals, with L = 63 and L = 127. The degradation of the co-ordination channels has been assumed to be $\Delta_{\text{COOR}} = 4,33$ dB. Table 9 reports the meaning of the symbols.

As indicated in figure 17 (right), to reduce mutual interference, the co-ordinations channels may be placed in the roll-off region of the DSNG signal. In order to minimize the mutual interference, the co-ordination signals may use a low spreading factor (i.e. L = 31, L = 63 or L = 127, according to the co-ordination channel bit-rate) and may be placed, for example, in the upper part of the frequency slot allocated to DSNG. In this configuration the centre frequency $f_{0, \text{COOR}}$ of the co-ordination signals may be computed by the following formula:

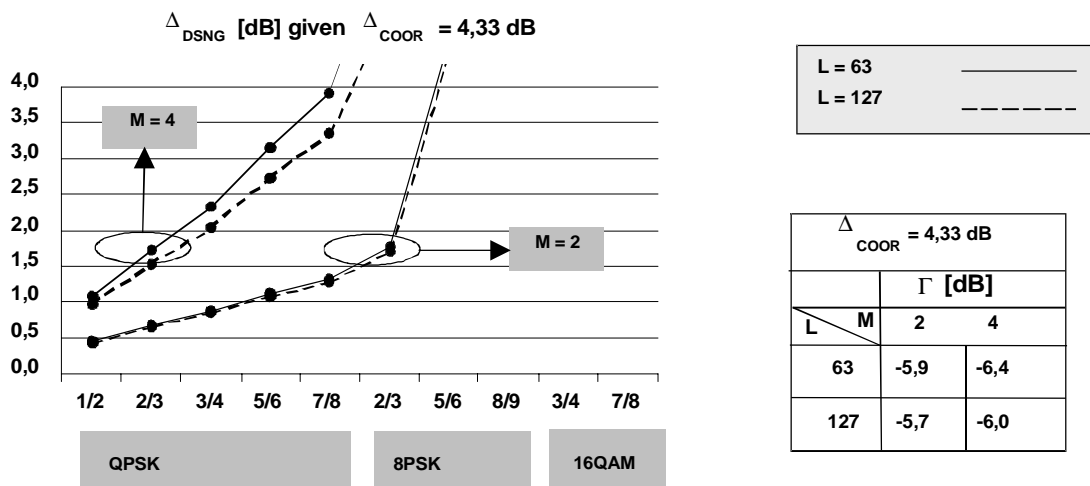

Figure 19

$$(2) \quad f_{0,COOR} = f_{0,DSNG} + BS / 2 - (1,35/2) R_{S,COOR}$$

where $f_{0,DSNG}$ is the centre frequency of the DSNG signal and BS the bandwidth of the frequency slot, $R_{S,COOR} = R_{S,chip}$ is the co-ordination channel symbol rate.

In the following, the achievable performance is given for two example configurations, based on the frequency allocations of formula (2) and choosing Γ equal -3 dB as a reasonable practical upper limit for the power density level of the co-ordination channels.

EXAMPLE 3: (Figure 20) 8 kbit/s co-ordination channels.

M unidirectional co-ordination channels are considered, each at 8 kbit/s, with a spreading factor of 63 and 127. The main DSNG signal has a symbol rate of 6,666 MBaud, thus occupying a frequency slot of 9 MHz. The roll-off region (from the -3 dB point to the slot margin) is 1,167 MHz wide, while the co-ordination signal bandwidth is about 0,5 MHz for spreading factor 63 and 1 MHz for spreading factor 127. Due to the roll-off filter effect, the mutual interference suppression A is about 5,5 dB for $L = 127$ and 9,7 dB for $L = 63$. The resulting performance degradations of the DSNG signal are reported in figure 19, assuming a Γ factor (ratio between the DSNG and each co-ordination channel spectral density divided by the spreading factor L) of -3 dB (the $-$ sign indicates that the co-ordination channels before SS have a spectral density higher than that of the DSNG signal). In the example, even in the case of $M = 6$ the DSNG degradation may be maintained below 0,5 dB for DSNG modulations up to 16QAM FEC rate 3/4.

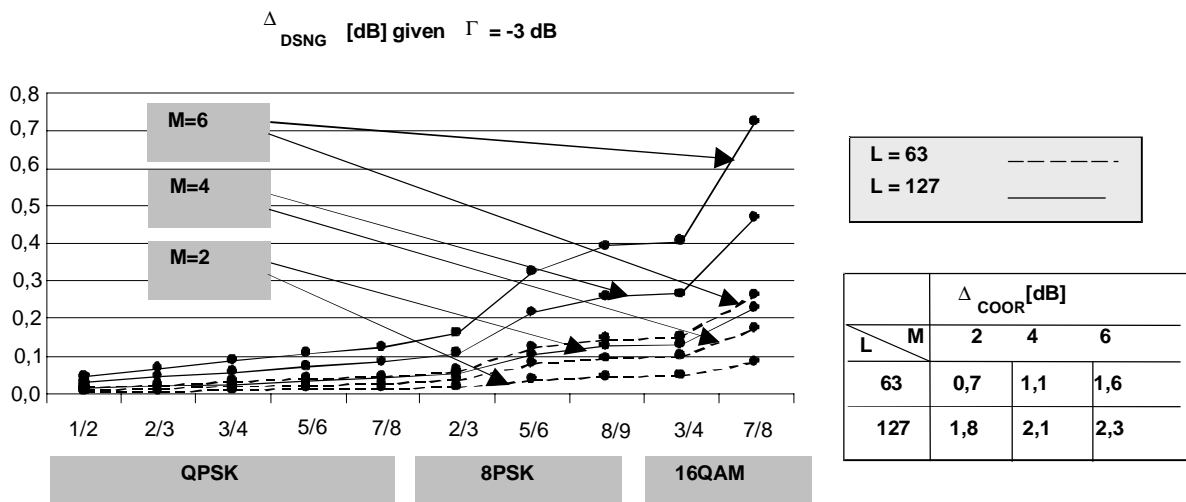

Figure 20

Figure 20: 8 kbit/s co-ordination channels in the "Roll-off" region of DSNG – Example performance degradation of DSNG ($R_S = 6,666$ MBaud) interfered with by M co-ordination signals, with $L = 63$ and $L = 127$. The ratio between the DSNG and each co-ordination channel spectral density divided by the spreading factor L has been assumed to be $\Gamma = -3$ dB. Table 9 reports the meaning of the symbols.

EXAMPLE 4: (Figure 21) 32 kbit/s co-ordination channels.

M unidirectional co-ordination channels are considered, each at 32 kbit/s, with a spreading factor of 31. The main DSNG signal has a symbol rate of 6,666 MBaud, thus occupying a frequency slot of 9 MHz. The roll-off region (from the -3 dB point to the slot margin) is 1,167 MHz wide, while the co-ordination signal bandwidth is about 1 MHz. Due to the roll-off filter effect, the mutual interference suppression A is about 5,5 dB. The resulting performance degradations of the DSNG signal are reported in figure 21, assuming a Γ factor of -3 dB (the $-$ sign indicates that the co-ordination channels before SS have a spectral density higher than DSNG). In the example, in the case of $M = 4$ the DSNG degradation may be maintained below 0,5 dB for DSNG modulations up to 8PSK FEC rate 2/3.

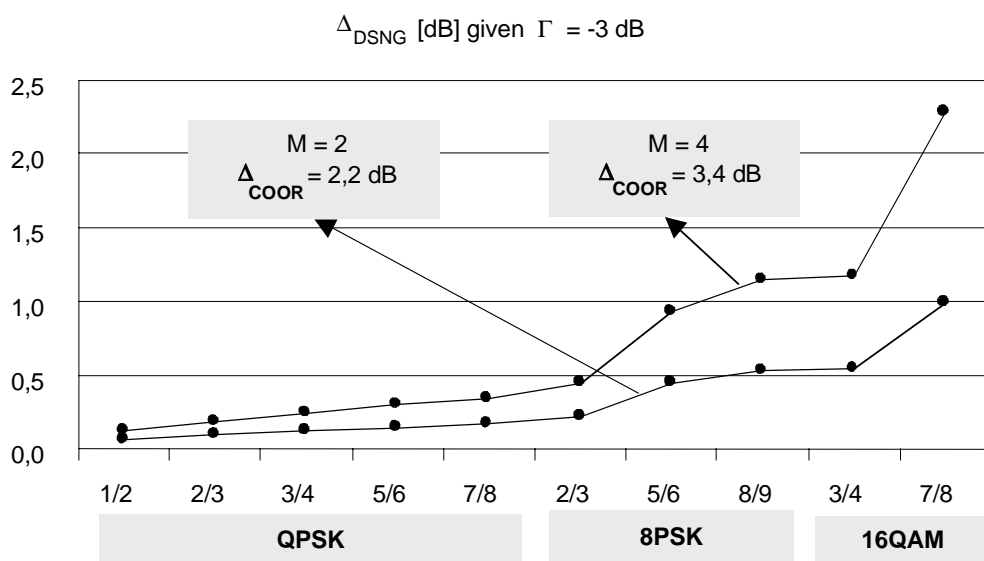

Figure 21

Figure 21: 32 kbit/s co-ordination channels in the "Roll-off" region of DSNG – Example performance degradation of DSNG ($R_S = 6,666$ MBaud) interfered with by M co-ordination signals, with $L = 31$. The ratio between the DSNG and each co-ordination channel spectral density divided by the spreading factor L has been assumed to be $\Gamma = -3$ dB, table 9 reports the meaning of the symbols.

6 Conclusions

The present document provides an overview of the capabilities of the DVB specification for DSNG services (EN 301 210 [1] and EN 301 222 [2]).

Several examples of the different configuration of the DSNG system and their corresponding co-ordination channels (modulation, symbol rate, coding rate, etc.) have been analysed for different potential applications (DSNG, fixed contribution links and connection with terrestrial networks).

The DVB-DSNG system, thanks to its flexibility to accommodate the required conditions on ruggedness against noise, interference, power and spectrum efficiency, is a significant step forward toward the increasing in quality and cost reduction for SNG and fixed contribution links by satellite.

Bibliography

The following material, though not specifically referenced in the body of the present document (or not publicly available), gives supporting information.

Reimers, U: "The European perspectives on Digital Television Broadcasting". Proceedings NAB'93 Conference, Las Vegas.

A. Morello, M. Visintin (1996): "Transmission of TC-8PSK digital television signals over Eurovision satellite links", EBU Technical Review No. 269.

A. Viterbi et al. (1989): "A pragmatic approach to trellis-coded modulation", IEEE Communication Magazine.

D. Delaruelle (1995): "A pragmatic coding scheme for transmission of 155 Mbit/s SDH and 140 Mbit/s PDH over 72 MHz transponders", Proceedings ICDSC-10 Conference, Brighton.

INTELSAT: "IESS-310 Specification".

A. Morello, V. Mignone (1998): "The New DVB Standard for Digital Satellite News Gathering", IBC'98 Conference, Amsterdam.

J. K. Holmes, "Coherent Spread Spectrum Systems", Krieger Publishing Company, Malabar, Florida.

R. De Gaudenzi, C. Elia, R. Viola (1992): "Bandlimited Quasi-Synchronous CDMA: A novel Satellite Access Technique for Mobile and Personal Communications", IEEE Journal on Selected Areas in Comm. Vol 10, No. 2, pp. 328-343.

M. Barbero et alii: "Towards Digital Production and Storage of Compressed Video: How to Find the Right Path?", Broadcast Asia 96 Conference Records.

A. Viterbi et alii (1989): "A pragmatic approach to trellis-code modulation", IEEE Comm. Magazine.

A. Morello, M. Visintin (1996): "Transmission of TC-8PSK digital television signals over Eurovision satellite links", EBU Technical Review, No. 269.

ITU-R Preliminary Draft New Recommendation ITU-R SNG 4SNG[XB]: "Common Operating Parameters to ensure interoperability of MPEG-2 DVB-S transmission of Digital Television News Gathering".

History

Document history		
V1.1.1	March 1999	Publication