

Covering the T199/4A, the Myarc 9640 and compatibles

MICROpendium

Volume 5 Number 2

March 1988

\$2.00

Myarc releases its hard/floppy controller

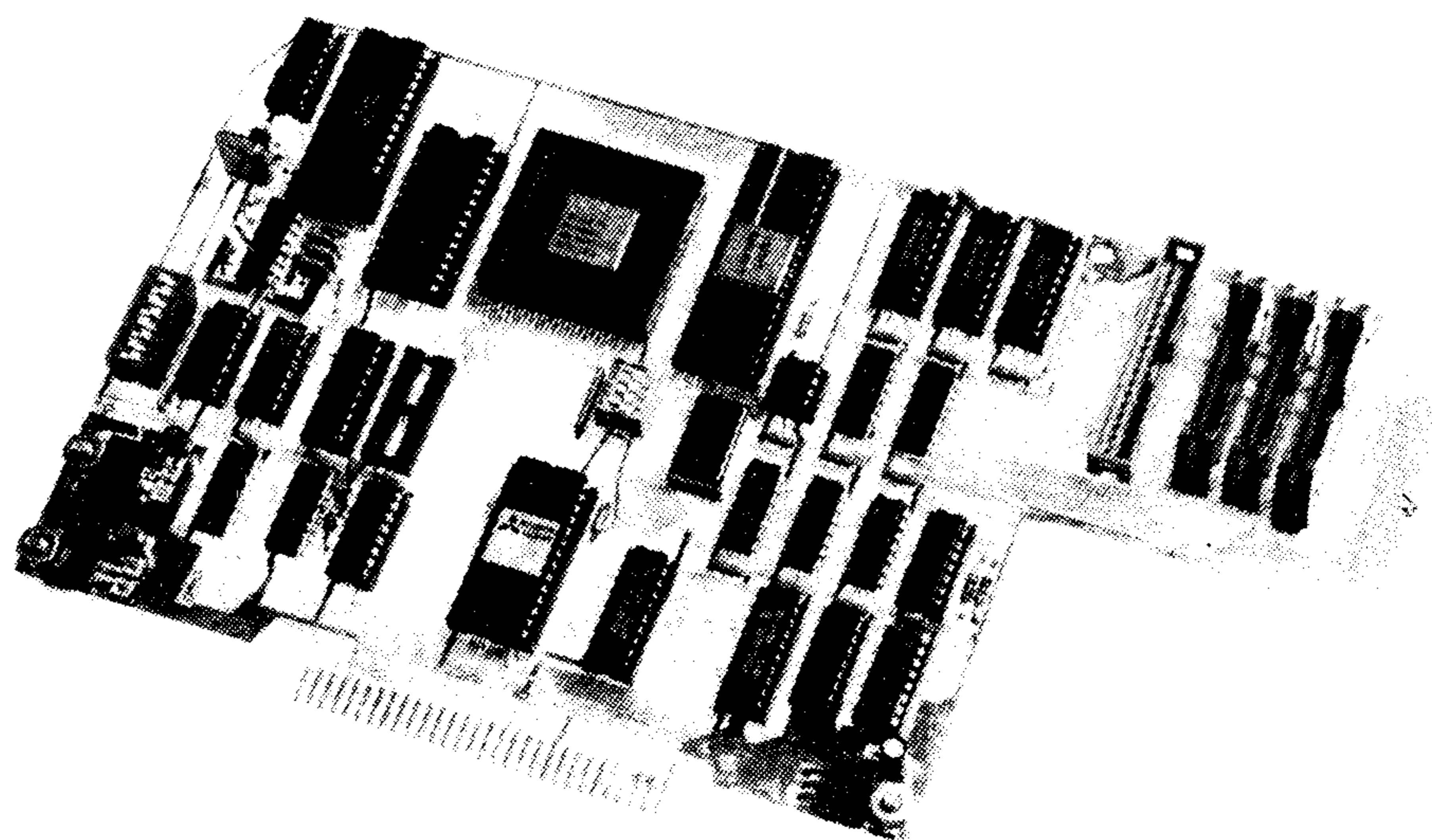

INSIDE

- A BASIC program to help with signed numbers
- Print disk catalogs on labels
- Getting a PEB ready for an internal hard disk
- A program to read files
- Onward through the fog using c99
- More User Supported Software

Reviews

- TELCO
- String Master
- Epson LX-800 printer

Geneve

- Mike Dodd discusses common problems
- An autodialer that runs from MDOS
- The Horizon RAMdisk meets the Geneve

The BIGGEST TI-99/4A SOFTWARE OFFER EVER

TEX+COMP™
TI USERS SUPPLY

PRESENTS:

TEXAS INSTRUMENTS
&
TEX+COMP
Announce
DRASTIC PRICE REDUCTIONS ON TEXAS INSTRUMENTS COMPUTER SOFTWARE

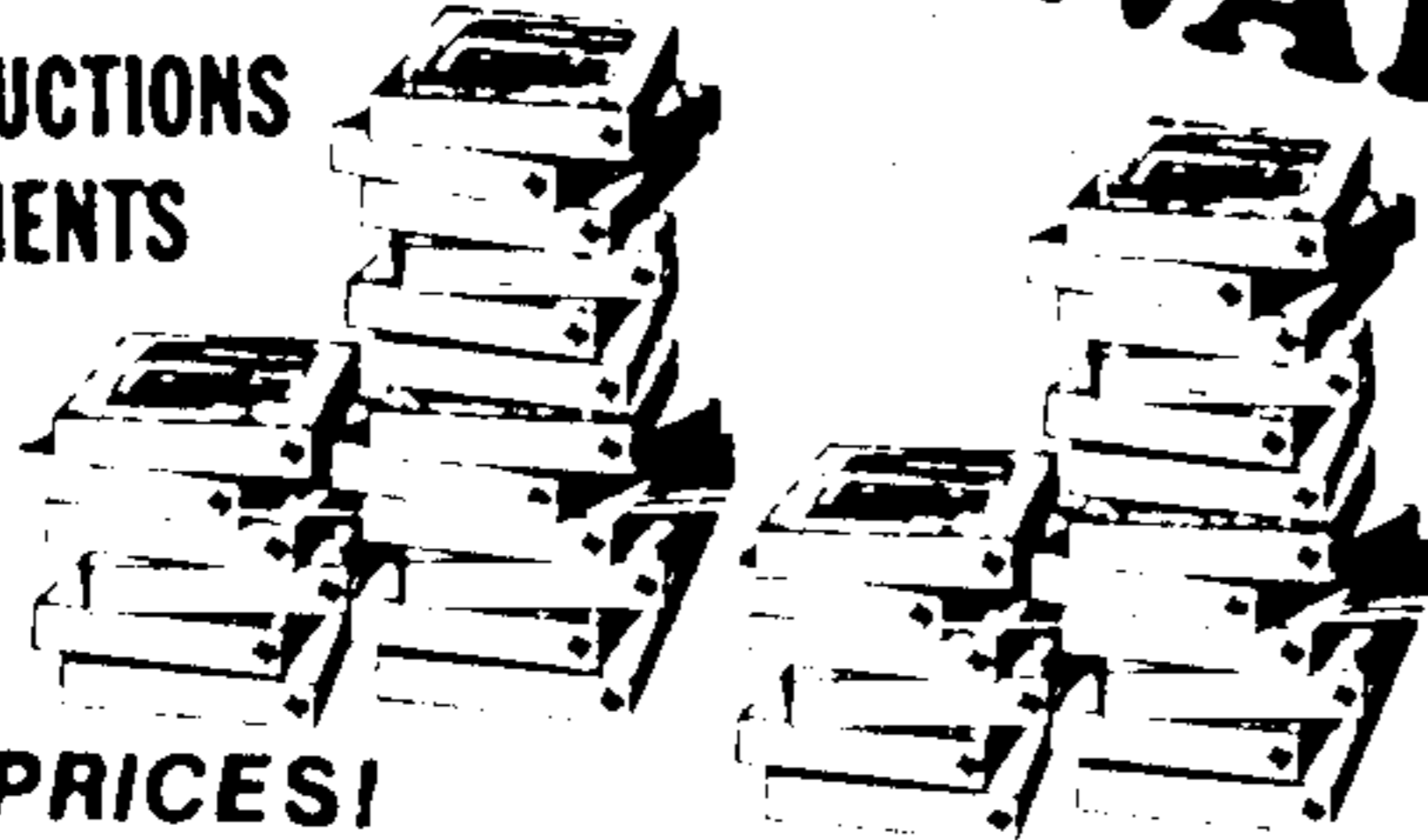

DISKETTE PROGRAMS NEW LOW PRICES!

- PHD 5026 Bridge Bidding I.....4.95
- PHD 5039 Bridge Bidding II.....4.95
- PHD 5041 Bridge Bidding III.....4.95
- PHD 5020 Music Maker Demo (use with module).....4.95

CASSETTE PROGRAMS

- see disk versions for req. i.e. TE-II
- PHT 6009 Music Skills Trainer.....4.95
 - PHT 6011 Computer Music Box.....4.95
 - PHT 6018 Market Simulation.....4.95
 - PHT 6031 Speak & Math.....4.95
 - PHT 6042 Spell Writer.....4.95
 - PHT 6026 Bridge Bidding I.....4.95
 - PHT 6039 Bridge Bidding II.....4.95
 - PHT 6041 Bridge Bidding III.....4.95
 - PHT 6020 Music Maker Demo (use with module).....4.95

MANAGEMENT AND SMALL BUSINESS

MODULES

- PHM 3006 Home Financial Decisions.....4.95
- PHM 3007 Household Budget Management.....4.95
- PHM 3022 Personal Real Estate.....4.95
- PHM 3016 Tax/Investment Rec. Keeping (disk req.).....4.95
- PHM 3035 Terminal Emulator II.....9.95
- PHM 3044 Personal Report Generator (PRK req.).....10.95
- PHM 3113 Multiplan.....24.95
- PHM 3112 TI Writer.....29.95

DISKETTE PROGRAMS NEW LOW PRICE!

- PHD 5001 Mailing List (upgraded version).....4.95
- PHD 5003 Personal Financial Aids.....4.95
- PHD 5021 Checkbook Manager.....4.95
- PHD 5022 Finance Manager.....4.95
- PHD 5024 Inventory Management.....4.95
- PHD 5027 Invoice Management.....4.95
- PHD 5029 Cash Management.....4.95
- PHD 5038 Lease/Purchase Decisions.....4.95
- PHD 5075 TI/Multiplan upgrade disk.....4.95

CASSETTE PROGRAMS

- PHT 6003 Personal Financial Aids.....4.95
- PHT 6038 Lease/Purchase Decisions.....4.95

TI-COUNT SMALL BUSINESS SOFTWARE

- General Ledger
- Accounts Receivable
- Accounts Payable
- Inventory
- Payroll
- Mail System

SPECIAL 1988 OFFER--ALL SIX PROGRAMS PLUS
AUTO COUNT AUTO EXPENSE
RECORD PROGRAM.....\$99.95

A \$250.00 SAVINGS !!!!!



MATH AND ENGINEERING

DISKETTE PROGRAMS NEW LOW PRICE!

- PHD 5006 Math Routine Library.....4.95
- PHD 5008 Electrical Engineering Library.....4.95
- PHD 5013 Graphing Package.....4.95
- PHD 5016 Structural Engineering Library.....4.95
- PHD 5044 AC Circuit Analysis.....4.95

CASSETTE PROGRAMS

- PHT 6006 Math Routine Library.....4.95
- PHT 6008 Electrical Engineering Library.....4.95
- PHT 6013 Graphing Package.....4.95
- PHT 6016 Structural Engineering Library.....4.95
- PHT 6044 AC Circuit Analysis.....4.95

****SPECIAL--ALL 5 OF THE ABOVE ON DISK OR TAPE---17.95

SPECIALS

Original TI Joysticks
\$7.95 (pair)

Replacement Console Power Supply (external transformer)
\$9.95

Replacement 99/4A Keyboards (plug in connection)
\$7.95

Cassette Cable
\$5.95
Console Dust Covers
\$7.95

PROTECT YOUR INVESTMENT WITH A BACK-UP TI99/4A

At only \$79.95 the Texas Instruments 99/4A home computer is still the wisest choice for any individual or family just starting out in computing. But for those of you who already own a 99/4A and have purchased hundreds or even thousands of dollars in peripherals and software, buying a back-up computer for under eighty dollars is the smartest and least expensive way to protect the investment in your system.

\$79.95*

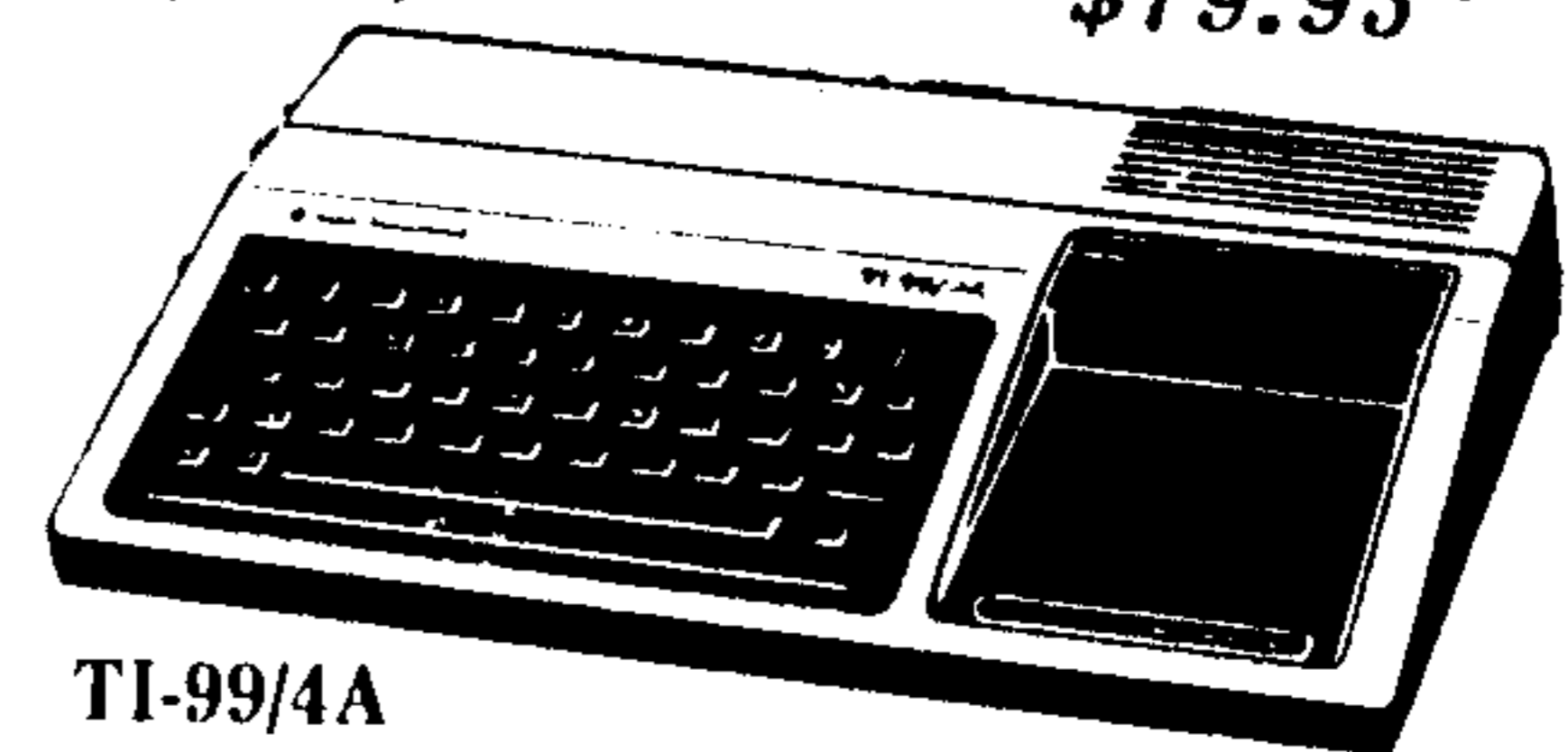

TI-99/4A

Are you using your 99/4A in the office and wish you had another to use at home? Is your family squabbling over who gets the computer first? You can put your back-up computer to use at once to solve these problems, and rest assured that your primary system is protected too.

Time is running out. The Texas Instruments home computer will not be available for sale much longer. Buy your back-up TI-99/4A now and protect your home computer system investment for the years to come.

*Shipping, handling & insurance on this special offer is \$10.00 (Continental U.S.) to any UPS deliverable address, HI, AK, Canada and APO slightly higher.

Send for **1988** Tex-Comp catalog & buyer's guide only \$2.00 (comes with \$5 savings certificate)

Send order and make checks payable to

TEX+COMP

PO. BOX 33064 - GRANADA HILLS CA 91344



AUTHORIZED DEALER



VISA and MASTERCARD
HOLDERS CALL DIRECT
(818) 366-6631
24 Hour Order Line

TERMS: All prices FOB Los Angeles. For fastest service use cashiers check or money order. Add 3% shipping and handling (\$3.00 Minimum). East of Mississippi 4 1/2%. Add 3% for Credit Card orders. Prices and availability subject to change without notice. We reserve the right to limit quantities.

NOTE: Payment in full must accompany all orders. Credit card. Company check or Money order for immediate shipment. Personal Checks require up to 4 weeks to clear. California orders add 6 1/2% sales tax.

1988 PRICES SLASHED

**NEW LOW PRICES ON
PERIPHERALS AND
SOFTWARE... OUR
LOWEST PRICES
EVER!!!!!!**

Tex-Comp
P.O. Box 33084, Granada Hills, CA 91344



**ORDER BY
PHONE**

Charge-It On Your
Visa or MasterCard

(818) 366-6631

24 HOURS a day-

Send for **1988** Tex-Comp catalog &
buyer's guide only \$2.00 (comes with \$5
savings certificate)

TI-99/4A Home Computer The System. The Software.

Better to start with. Better to stay with. Better to grow with.

Software

HOME ENTERTAINMENT

MODULES

| | | |
|-----------|----------------------------------|-------|
| PHM 3023 | Hunt the Wumpus..... | 4.95 |
| PHM 3030 | Amazing..... | 4.95 |
| PHM 3052 | Tombstone City..... | 4.95 |
| PHM 3053 | TI Invaders..... | 4.95 |
| PHM 3054 | Car Wars..... | 4.95 |
| PHM 3057 | Munch Man..... | 4.95 |
| PHM 3056 | Alpiner..... | 4.95 |
| PHM 3112 | Parsec..... | 4.95 |
| PHM 3031 | The Attack..... | 4.95 |
| PHM 3032 | Blasto..... | 4.95 |
| PHM 3194 | Jawbreaker II..... | 5.95 |
| PHM 3110 | Chisholm Trail..... | 5.95 |
| PHM 3034 | Hustle..... | 6.95 |
| PHM 3037 | Manman..... | 6.95 |
| PHM 3025 | Mind Challengers..... | 8.95 |
| PHM 3036 | Zero Zap..... | 8.95 |
| PHM 3024 | Indoor Soccer..... | 8.95 |
| PHM 3038 | Connect Four..... | 8.95 |
| PHM 3042D | Tunnels of Doom (with disk)..... | 9.95 |
| PHM 3042T | Tunnels of Doom (with tape)..... | 9.95 |
| PHM 3067 | Othello..... | 9.95 |
| PHM 3149 | Space Bandits..... | 9.95 |
| PHM 3220 | Micro Surgeon..... | 9.95 |
| PHM 3219 | Super Demon Attack..... | 9.95 |
| PHM 3224 | Moonsweeper..... | 9.95 |
| PHM 3222 | Fathom..... | 9.95 |
| PHM 3233 | Burgertime..... | 9.95 |
| PHM 3131 | Moonmine..... | 9.95 |
| PHM 3146 | Munchmobile..... | 11.95 |
| PHM 3197 | Slymoids..... | 15.95 |
| PHM 3225 | Star Trek..... | 15.95 |
| PHM 3226 | Buck Rogers..... | 15.95 |
| PHM 3227 | Congo Bongo..... | 15.95 |

DISKETTE PROGRAMS **NEW LOW PRICES!**

| | | |
|-------------|---|------|
| PHD 5002 | TI-TREK (TE-II req. for speech)..... | 4.95 |
| PHD 5010 | Mystery Melody..... | 4.95 |
| PHD 5015 | Oldies But Goodies I..... | 4.95 |
| PHD 5017 | Oldies But Goodies II..... | 4.95 |
| ****SPECIAL | Oldies But Goodies I & II..... | 7.95 |
| PHD 5025 | Sat. Night Bingo (Ex-Basic & Speech)..... | 4.95 |
| PHD 5037 | Draw Poker (Ex-Basic)..... | 4.95 |

CASSETTE PROGRAMS

| | | |
|-------------|---|------|
| PHT 6002 | TI-Trek (TE-II req. for speech)..... | 4.95 |
| PHT 6010 | Mystery Melody..... | 4.95 |
| PHT 6015 | Oldies But Goodies I..... | 4.95 |
| PHT 6017 | Oldies But Goodies II..... | 4.95 |
| ****SPECIAL | Oldies But Goodies I & II..... | 7.95 |
| PHT 6026 | Sat. Night Bingo (Ex-Basic & Speech)..... | 4.95 |
| PHT 6037 | Draw Poker (Ex-Basic)..... | 4.95 |

ADVENTURES

| | | |
|--|--|-------|
| PHM 3041D | Adventure Module & Pirate Adv.(disk).... | 6.95 |
| PHM 3041T | Adventure Module & Pirate Adv.(tape).... | 6.95 |
| ADVENTURE SERIES (must be used with PHM 3041 module) specify disk or tape with order | | |
| | Adventureland..... | 4.95 |
| | Mission Impossible..... | 4.95 |
| | Voodoo Castle..... | 4.95 |
| | The Count..... | 4.95 |
| | Strange Odyssey..... | 4.95 |
| | Mystery Fun House..... | 4.95 |
| | Pyramid of Doom..... | 4.95 |
| | Ghost Town..... | 4.95 |
| | Savage Island I&II (two adventures)..... | 4.95 |
| | Golden Voyage..... | 4.95 |
| | Knight Ironheart Adventure..... | 4.95 |
| ****SPECIAL-ALL ABOVE ADVENTURES ON DISK OR TAPE.. | | 17.95 |
| | Spiderman Adventure..... | 7.95 |
| | Incredible Hulk Adventure..... | 7.95 |
| | Buckaroo Banzai Adventure (based on the movie)..... | 7.95 |
| | Sorcerer of Claymorgue Castle..... | 7.95 |
| ****SPECIAL-ALL OF THE ABOVE FOUR + HINT BOOK + TWO NEW BONUS ADVENTURES..... | | 17.95 |
| ****SUPER ADVENTURE SPECIAL-BOTH OF THE ABOVE SPECIALS +COMPLETE HINT BOOK+ADVENTURE MODULE | | 29.95 |
| PHM 3189 | Return to Pirate's Island (self contained adventure on module with graphics)..... | 11.95 |
| NBX Programs (NBX Unit Required) | | |
| PHM 3154 | Terry Turtle's Adventure..... | 2.95 |
| PHM 3155 | I'm Hiding..... | 2.95 |

COMPUTER PROGRAMMING AIDS

MODULES

| | | |
|----------|----------------------------------|-------|
| PHM 3999 | Super Extended Basic..... | 59.95 |
| PHM 3026 | Extended Basic..... | 49.95 |
| PHM 3058 | Editor Assembler..... | 19.95 |
| PHM 3058 | Mini Memory (with Writer I)..... | 38.95 |

DISKETTE PROGRAMS

| | | |
|----------|--|-------|
| PHD 5007 | Teach Yourself 99/4A Basic..... | 4.95 |
| PHD 5019 | Teach Yourself Extended Basic..... | 4.95 |
| PHD 5004 | Programming Aids I..... | 4.95 |
| PHD 5005 | Programming Aids II..... | 4.95 |
| PHD 5012 | Programming Aids III..... | 4.95 |
| PHD 5077 | Programming Aids I, II, III..... | 9.95 |
| PHD 5067 | Beginning Basic Tutor..... | 4.95 |
| PHD 5076 | Text to Speech (Ex Basic Speech)..... | 4.95 |
| PHD 5098 | TI Forth & manual (Ed/Assem req.)..... | 19.95 |
| PHD 5078 | TI Forth Demo Disk (Ed/Assem)..... | 4.95 |
| PHD 5079 | TI Forth Source Code (2 disks)..... | 7.95 |

CASSETTE PROGRAMS

| | | |
|----------|------------------------------------|------|
| PHT 6006 | Programming Aids I..... | 4.95 |
| PHT 6007 | Teach Yourself 99/4A Basic..... | 4.95 |
| PHT 6019 | Teach Yourself Extended Basic..... | 4.95 |
| PHT 6067 | Beginning Basic Tutor..... | 4.95 |

EDUCATION

MODULES

| | | |
|----------|---------------------------------------|-------|
| PHM 3002 | Early Learning Fun..... | 4.95 |
| PHM 3003 | Beginning Grammar..... | 4.95 |
| PHM 3010 | Physical Fitness..... | 4.95 |
| PHM 3010 | Music Maker..... | 9.95 |
| PHM 3021 | Weight Control & Nutrition... .. | 10.95 |
| PHM 3109 | TI LOGO II (32K req.)..... | 19.95 |
| PHM 3015 | Early Reading (speech syn. req) | 9.95 |
| PHM 3043 | Reading Fun..... | 9.95 |
| PHM 3046 | Reading On..... | 9.95 |
| PHM 3047 | Reading Roundup..... | 9.95 |
| PHM 3048 | Reading Rally..... | 9.95 |
| PHM 3082 | Reading Flight..... | 9.95 |
| PHM 3027 | Addition & Subtraction I..... | 9.95 |
| PHM 3028 | Addition & Subtraction II..... | 9.95 |
| PHM 3029 | Multiplication I..... | 9.95 |
| PHM 3049 | Division I..... | 9.95 |
| PHM 3050 | Numeration I..... | 9.95 |
| PHM 3051 | Numeration II..... | 9.95 |
| PHM 3060 | Scholastic Spelling 4 (speech)..... | 9.95 |
| PHM 3061 | Scholastic Spelling 5 (speech)..... | 9.95 |
| PHM 3062 | Scholastic Spelling 6 (speech)..... | 9.95 |
| PHM 3091 | Milliken Subtraction..... | 9.95 |
| PHM 3092 | Milliken Multiplication..... | 9.95 |
| PHM 3093 | Milliken Division..... | 9.95 |
| PHM 3094 | Milliken Integers..... | 9.95 |
| PHM 3098 | Milliken Number Readiness.... | 4.95 |
| PHM 3099 | Milliken Laws of Arithmetic.. | 4.95 |
| PHM 3100 | Milliken Equations..... | 4.95 |
| PHM 3101 | Milliken Measurement of Formulas..... | 4.95 |
| PHM 3114 | Alligator Mix..... | 6.95 |
| PHM 3115 | Alien Addition..... | 6.95 |
| PHM 3119 | Meteor Multiplication..... | 6.95 |
| PHM 3118 | Minus Mission..... | 6.95 |
| PHM 3177 | Face Maker..... | 9.95 |
| PHM 3178 | Story Machine..... | 9.95 |

DISKETTE PROGRAMS

| | | |
|----------|---------------------------------------|------|
| PHD 5009 | Music Skills Trainer..... | 4.95 |
| PHD 5011 | Computer Music Box..... | 4.95 |
| PHD 5018 | Market Simulation..... | 4.95 |
| PHD 5030 | Speak & Spell II (Ex Basic req.)..... | 9.95 |
| PHD 5031 | Speak & Math (TE-II req.)..... | 4.95 |
| PHD 5042 | Spell Writer (TE-II req.)..... | 4.95 |

Contents

MICROpendium

MICROpendium is published 12 times annually for \$20 per year by Burns-Koloen Communications Inc., 16606 Terrace Dr., Austin, TX 78728. Application to Mail at Second-Class Postage Rates is Pending at Round Rock, Texas. POSTMASTER: Send address changes to MICROpendium, P.O. Box 1343, Round Rock, TX 78680.

No information published in the pages of MICROpendium may be used without permission of the publisher. Only computer user groups that have exchange agreements with MICROpendium may excerpt articles appearing in MICROpendium without prior approval.

While all efforts are directed at providing factual and true information in published articles, the publisher cannot accept responsibility for errors that appear in advertising or text appearing in MICROpendium. The inclusion of brand names in text does not constitute an endorsement of any product by the publisher. Statements published by MICROpendium which reflect erroneously on individuals, products or companies will be corrected upon contacting the publisher.

Unless the author specifies, letters will be treated as unconditionally assigned for publication, copyright purposes and use in any other publication or brochure and are subject to MICROpendium's unrestricted right to edit and comment.

Display advertising deadlines and rates are available upon request.

All correspondence should be mailed to MICROpendium at P.O. Box 1343, Round Rock, TX 78680. We cannot take responsibility for unsolicited manuscripts but will give consideration to anything sent to the above address. Manuscripts will be returned only if a self-addressed stamped envelope is included.

Foreign subscriptions are \$25.25 (Canada and Mexico); \$23.50, surface mail to other countries; \$37 airmail to other countries.

All editions of MICROpendium are mailed from the Round Rock (Texas) Post Office.

Mailing address: P.O. Box 1343, Round Rock TX 78680

Telephone: (512) 255-1512

Source: TI4596

CompuServe: 75156,3270

Delphi TI NET: MICROPENDIUM

John Koloen.....Publisher
Laura Burns.....Editor

Regena on BASIC

Signed numbers, more or less.....Page 12

c99

Onward through the fog.....Page 20

Fileread

Another program that displays a variety of file types directly to the screen.....Page 26

Text-to-speech

Using the GRAM Kracker to access this TEII feature...Page 28

Geneve 9640

Solutions to some problems.....Page 30

Autodialing from MDOS.....Page 31

Using the Horizon RAMdisk.....Page 32

Myarc's new disk controller

For hard and floppy disks with the TI or 9640.....Page 33

PEB meets hard disk

Installing a hard disk in the PEB.....Page 34

Reviews

Telco.....Page 35

String Master.....Page 37

Epson LX-800 Printer.....Page 38

Newsbytes

More BBSes, a book on controlling printers, and an upgrade for Asgard's Legends.....Page 41

User Notes

XBASIC with DV/80 files, recycling printer ribbons, and making those numbers stand out.....Page 42

Classified.....Page 47

Programming conventions

- Here are some tips to help you when entering programs from MICROpendium:
1. All BASIC and Extended BASIC programs are run through Checksum, the numbers that follow exclamation at the end of each program line. Do not enter these numbers or exclamation points. Checksum was published in the November 1987 edition.
 2. Long XBASIC lines are entered by inputting until the screen stops accepting characters, pressing Enter, pressing FCTN REDO, cursoring to the end of the line and continuing input.

Sensational Prices!!! ... On Our Most Popular Hardware and Software!!

TOP QUALITY PERIPHERALS

from
CorComp • Myarc

CORCOMP

Triple Tech. Board for PE Box includes clock/calendar, printer buffer, and speech synthesizer connection.

| | | |
|------------------------|---|----------|
| 34643 | | \$138.00 |
| 34639 | Clock/Calendar. Stand-alone | \$79.95 |
| 34396 | 9900 32K Micro Memory. Stand-alone 32K. | \$99.95 |
| The Memory Plus series | | |
| 41070 | 256K Memory Plus Stand-Alone | \$219.00 |
| 41633 | 512K Memory Plus Stand-Alone | \$279.00 |
| 41051 | 256K Memory Plus Card | \$196.00 |
| 41065 | 512K Memory Plus Card | \$253.00 |

See "Best Selling Hardware" for more CorComp products.

MYARC

| | | |
|-------|--|----------|
| 34324 | 256K Card | \$179.00 |
| 42245 | 512K Card | \$239.00 |
| 38179 | Extended BASIC Level IV | \$59.95 |
| 38395 | 256K Card with Extended BASIC Level IV | \$249.00 |
| 42231 | 512K Card with Extended BASIC Level IV | \$289.00 |
| 38198 | 512K Upgrade Kit for the 128K Card | \$109.95 |

See "Best Selling Hardware" for more Myarc products.

COMPUTER WAR

Based on the hit movie "War Games"...one of our best sellers. Can you crack the code and destroy the simulated enemy missile before the world is engulfed in a thermonuclear holocaust?

42480 TI CARTRIDGE.....\$24.95

MICROPENDIUM SPECIAL

THE 39¢ DISKETTE!



Are you paying too much for diskettes? Try our first quality, prime, 5 1/4" diskettes (no rejects, no seconds) at these fantastic sale prices and save, save, SAVE! Disks are packaged in boxes of 50; each box contains 5 shrink-wrapped 10-packs that include diskettes in sleeves, labels, and write-protect tabs.

Each diskette is certified to be 100% error free and comes with a lifetime warranty (if you have a problem, we'll replace the diskette). All diskettes include hub reinforcement rings and write-protect notch.

32391 SS, DD Diskettes Box of 50
\$19.50
(39¢ each!)

32403 DS, DD Diskettes \$24.50
(49¢ each!)

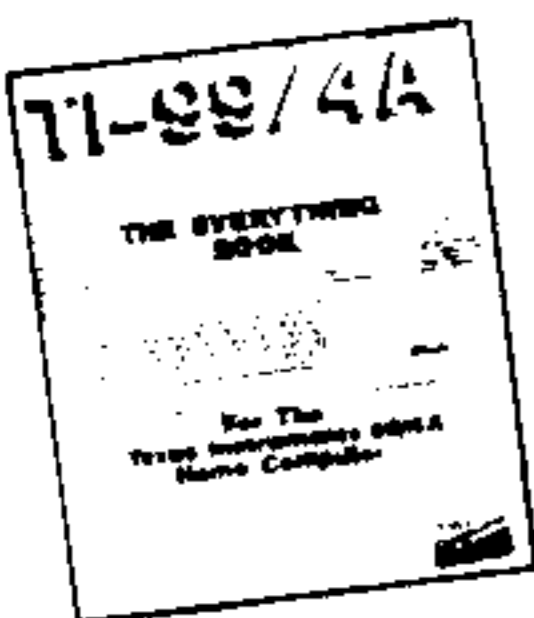

FREE!
"EVERYTHING BOOK"
For the
TI Home Computer
Order Item #25982



AVAILABLE FROM
YOUR FRIENDS AT



We gladly accept
mail orders!

P.O. Box 6578
South Bend, IN 46660

**Questions? Call
219/259-7051**

NEW
LOW
PRICE!



MicroPal® Extended BASIC

MicroPal's Extended BASIC package now includes two free software programs! Bestsellers **Typewriter** and **Name-It** from Extended Software are included in disk and cassette versions with complete manual — absolutely free!! You can immediately begin using the power of Extended BASIC for word processing and data

base functions.

MicroPal Extended BASIC is unconditionally guaranteed to be 100% compatible with all programs written in TI Extended BASIC. With this powerful, high-level language, programmers

can have automatic access to the 32K memory expansion, utilize sprite graphics for smooth motion and animation, auto-load disk based programs, and add speech with a 400 word built-in vocabulary! Package includes Extended BASIC on a convenient plug-in cartridge with 240 page manual. Sug. Retail \$89.95

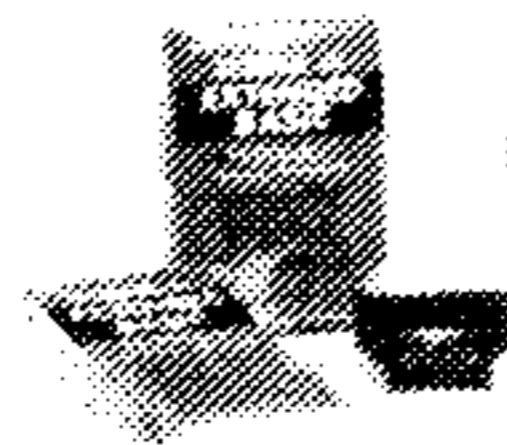

32967

ONLY \$49.95!!

MYARC GENEVE COMPUTER



Here's the good news... the new Myarc Geneve Computer you've been hearing about is to be shipping by press time! Imagine a computer that is 99/4A compatible but has the speed and incredible graphics capabilities that even IBM, Amiga, and Atari ST owners would envy!

The Geneve is truly a breakthrough... since it's offered on a card, and is compatible with your existing Expansion Box, disk controller, and RS-232 cards, its advanced features can be offered at a cost much lower than you would expect to pay for a system of this power and versatility!

Features include standard or enhanced keyboard, 80 column display, 640K of RAM plus 128K VDP RAM, and conversion instructions.

\$Call Today for Lowest Price!\$

BEST-SELLING HARDWARE!

STAR MICRONICS PRINTER

75077 NX100 Rainbow Color Printer.....\$269.95



32986 MYARC RS-232 CARD\$ 99.95

13300 CORCOMP RS-232 CARD\$ 89.95

42250 PARALLEL PRINTER INTERFACE\$ 44.95

29784 CORCOMP RS-232 INTERFACE\$127.00

29802 CORCOMP 9900 MICRO-EXPANSION SYSTEM\$329.00

32972 MYARC DISK CONTROLLER CARD\$CALL

29770 CORCOMP DISK CONTROLLER CARD SALE! \$149.95

13315 CORCOMP 32K MEMORY CARD\$119.95

20164 BOX WITH POWER SUPPLY for external disk drive\$ 59.95

31173 WICO 3-WAY GATELOCK JOYSTICK\$ 24.95

10285 TI JOYSTICK ADAPTER\$ 4.95

42442 TAC 5™ JOYSTICK. Requires TI Adapter\$ 14.95

42086 SLIK STICK™ JOYSTICK. Requires TI Adapter \$ 6.95

13329 NAVARONE CARTRIDGE EXPANDER\$ 24.95



| SHIPPING CHARGES | |
|-------------------|--------|
| ORDER AMOUNT | CHARGE |
| less than \$20.00 | \$3.75 |
| \$20.00-\$39.99 | 4.75 |
| \$40.00-\$74.99 | 5.75 |
| \$75.00-\$149.99 | 6.75 |
| \$150.00-\$299.99 | 7.75 |
| \$300 & up | 8.75 |

Foreign Orders add \$4.00;
heavy items ship at actual cost

NO EXTRA FEE FOR CHARGES



We verify charge card addresses

**ORDER TOLL FREE
1-800-348-2778
INDIANA 1-800-225-6838**



NOTE: Due to publishing lead-times, product prices and specifications are subject to change without notice

Comments

Clarification on Checksum

Most readers have probably figured this out already, but the article we published with the Checksum program in the October 1987 edition was a bit more confusing than it should have been. The Checksum program was available in two formats: Assembly language and X BASIC CALL LOADs. We published the X BASIC version. Unfortunately, the article contains references to running the assembly version. For the record, after you've entered the Check and Checksum programs, the only thing you need to do to use either is to load them into memory and enter RUN. Checksum is used to process an existing program so that checksums are added to each program line. The Check program is memory resident and is RUN prior to inputting a program with checksums. Check then calculates the checksum total as each line is entered. If the checksum total doesn't match the checksum of the program line you are inputting, you know there is a mistake in your entry.

Even this explanation seems confusing.

CAN'T ANSWER ALL INQUIRIES

We hate to admit it, but we just can't answer every inquiry we get from readers. There are only two of us at MICROpendium and we get dozens of letters each week from readers seeking answers to questions ranging from 'What's the best color printer to use with the TI,' to 'What am I doing wrong with this assembly language program I've written.'

I wish we were in a position to answer everything, but many of the questions require more knowledge and expertise than we can muster. Even the simplest inquiries can take hours to document. Those that we can answer in a straightforward manner, we try our best to do. Those with technical questions about the Geneve we forward to Mike Dodd in hopes that he can help out. Those with questions we can't directly answer, we try to publish in our Reader to Reader column (but only if the writer allows us to print his address). And, of course, sometimes we just get bogged down after having had the best of intentions to answer particular inquiries in a timely manner.

To those who have had to write us several times to get an answer, we apologize. We don't want to discourage anyone from contacting us with a question, but we want you to understand that you'll have the best

chance of a definitive answer if you make note that we include the inquiry in our Reader to Reader column if we are unable in any other way to provide a successful resolution. (Our policy, unless we are told otherwise, is not to publish telephone numbers or street addresses of readers.)

WHAT CARTRIDGES DO YOU WANT?

We are still soliciting responses from 9640 users concerning the software that currently doesn't run on the Geneve that they would like to see modified so that it will run on the Geneve. Response so far seems to indicate that few Geneve users are interested in running most currently non-compatible TI software on the Geneve. If there's a cartridge-based program that you'd like to run on the Geneve, send us a note, addressed to: Patches, c/o MICROpendium, P.O. Box 1343, Round Rock, TX 78680. The 20 or so most frequently mentioned programs we be modified by Myarc to operate on the 9640.

NEW PRODUCTS OF NOTE

Several new products have been released recently, including a new terminal program and the expected release of the Myarc Hard and Floppy Disk Controller card on March 18.

TELCO, by Charles Earl, is an exceptional terminal program that differs dramatically in its design and operation from other terminal programs for the TI. It is a highly modularized program that uses windows. It operates in 40 and 80 columns and is compatible with the 9640 and the 4A. A review of the program is included in this edition.

The Myarc HFDC was slated for release to dealers on March 18, according to Myarc's marketing guru Jack Riley. The card is compatible with both the Geneve and the 4A and uses the PEB for both computers. There's a story about it elsewhere in this edition, as well as an article for hardware hackers on how to set up a power supply for a PEB internal hard disk.

A CLARIFICATION ON FILE READER

In this edition there is a program by Robert Carmany that reads files of various types to the screen. Near the end, it indicates that program line 1 (later resequenced to 100) is to be run through PRESCAN—IT!. If you don't have PRESCAN—IT!, just enter the program line as it appears. It will work fine. —JK

CALENDAR MAKER 99

Calendar Maker 99 is the only program that allows you to create large, detailed, picture calendars on a TI-99/4A or Myarc Geneve 9640!

Ideal for the teacher, student, business person, office worker, or anyone else that wants to create a calendar, CM99 will let you create customized calendars quickly and easily.

CM99 has the following features:

- Create a calendar a month or a year at time for any year between 1600 and 2400!
- Put small pictures or text notes on any individual day of the calendar. CM99 lets you zoom in on a day and type a note or place a picture.
- Define the border style, all the typefaces and calendar headers.
- Print month calendars with or without a half-page picture and a 3-13 line user-definable message!
- Print year calendars 2 months to a page.
- Easy-to-use, even an adult can use it!
- Use TI-Artist Instances on the days.
- A complete library of small pictures, typefaces, borders and example files are provided with the program - get started right out of the box!
- Fast.
- Extensive documentation included.

CALENDAR MAKER 99 can be used to create customized calendars for any application. If you use calendars, and don't want to pay the high printing and typesetting costs of creating a custom calendar for your business, work, school or home, then **Calendar Maker 99** is for you! Requires: 32K, TI Extended BASIC, Epson or compatible (Panasonic, TI, NEC, HP, IBM, etc.) printer, and a disk system. Functions fine with a single drive but two are recommended. The **Picasso** drawing program is also recommended, but not required. Available for only:

\$19.95 and \$.75 S&H

ANNOUNCING ASGARD SOFTWARE'S CALENDAR MAKER 99

FOR THE FIRST TIME

Create full-page one-month picture calendars or 6-page full-year calendars - quick and easy!

CALENDAR MAKER 99 is the only calendar program that lets you generate a beautiful custom calendar with pictures and text on any date! It lets you create a picture calendar for any month of any year from 1600-2400. Get it TODAY!!

| JULY | | | | | | 1988 |
|--------|--------|---|-----------|----------|---|------------------------------|
| SUNDAY | MONDAY | TUESDAY | WEDNESDAY | THURSDAY | FRIDAY | SATURDAY |
| | | | | | | 2 Cousin Ethel's Birthday |
| 3 | | 5 Stay in bed from too much July 4th celebrating! | 6 | 7 | 8 | |
| | 11 | 12 | 13 | | 15 | 16 |
| 17 | 18 | 19 Aunt Frick sets out of prison - arrange bus ticket. | 20 | 21 | 22 | |
| 24 | 25 | 26 | | 28 | 29 Cecil Broderick set his Drum set - arrange to sell house. | 30 |
| 31 | | | | | | |

ASGARD SOFTWARE
Box 10306
Rockville, MD 20850

ASGARD SOFTWARE
P.O. BOX 10306
ROCKVILLE, MD 20850
(301)559-2429

Feedback

Review too harsh

Your product reviews influence me a lot in the programs that I buy and the ones I don't buy. However, in the case of Certificate 99 (reviewed December '87) I had already purchased it before your review came out. Your review is accurate, but it is unduly critical. This is a first rate program, so far as I know — the only one like it for our computer, and reasonably priced. If you take a survey of the folks who own Certificate 99, I am sure they would rate it an "A" instead of a "B." My unofficial survey of the Dallas TI Home Computer Group indicates more than 20 percent of the group have purchased Certificate 99.

If Great Lakes Software does offer a Certificate 99-Pal, I know a lot of folks who would be interested in buying one.

Tom Hall
Euless, Texas

Cleaning contacts

Regarding the January 1988 article on cleaning GROM cartridge and cartridge port contacts, I would like to suggest the following:

Only when severe tarnishing of contacts is suspected will disassembly be required. Cartridge and/or port contacts should then be cleaned with a typewriter eraser, followed by rubbing with a soft cloth on which some TV tuner cleaner has been sprayed.

For minor maintenance, a flat narrow device such as a 1/2-inch-wide putty knife should be wrapped in a single layer of soft cloth, sprayed with some TV tuner spray, and rubbed several times across the contacts of the cartridge and/or into the GROM port socket. You will probably see dark gray or even black residue coming off on the rag. Move the rag on the spatula or putty knife to a clean spot on the rag, respray with cleaner and rub again several times.

Sylvester C. Seals
Philadelphia, Pennsylvania

Yearn no more

In the January "Feedback" column, Dan Eichler yearned for TI-II sound and graphics at 1200 baud.

Yearn no more, Dan! The TE-II is alive and well on The Phoenix (713) 537-0741, 300/1200 baud.

In addition to the standard features and on-line RLE pictures, The Phoenix continues to support TE-II users. Dan (and all TE-II users) can call at 300 baud with the TE-II and download a compressed/archived file called TE2/12. It contains a 1200 baud patch and docs describing installation of an interrupt switch in the Speech Synthesizer. Armed with these aids, it is possible to have TE-II graphics, music and speech at 300 or 1200 baud.

I continually receive calls from TI users who are just starting to explore telecommunications economically with the TE-II. Even "old-timers" are discovering the versatility of this cartridge.

Bill Rister
Houston, Texas

A long four months

I recently ordered a couple of back issues from 1984 and I noticed that the feeling of some people at the time was rather down on the TI lasting very long and that it would probably be over in a few months — this must be the longest four months in history. Do you ever hear anything about how PCjr is doing?

Bartley Busse
Neidpath, Saskatchewan, Canada

Copying files

The "Getting started with MDOS" article by Walt Howe in your January 1988 issue has one error that should be pointed out. He states, "Exactly the same rules apply to designating drives for file copying with the COPY command" as do the rules for DISKCOPY. This is not so. The file is copied from the prompt drive to the drive specified in the command line. The command:

A>COPY TEXTFILE B:
will copy the file "TEXTFILE" from drive A to drive B.

A comment is in order concerning the DISKCOPY routine in DOS. This routine may be convenient for users with single-drive systems, but for others using double-sided, double or quad-density, multi-drive systems, it is just plain S..L..O..W... I miss the turbocopy option of the CorComp manager. Also, I would like to pass on an undocumented tip concerning the FORMAT command. If you omit the "/V" after the

FORMAT command and insert a volume name, such as:

A>FORMAT DISKNAME/2/18
DOS will automatically use "DISKNAME" as the volume name and will not ask for a volume name before formatting the diskette.

Bob Sherburne
North Las Vegas, Nevada

Don't use an eraser

The article "Cleaning module contacts" in the Jan. '88 issue was right on target. Our solder coated contacts in both the modules and the console edge connector are the weak link in everyone's system. These types of connections were also the death of the TRS-80 Model 1 computers; ask a Model 1 owner about computer lockups. Constant cleaning is the only way to maintain a good connection where a tin/lead coating is present. Be that it may, I must take exception with what Ron is saying. Don't get me wrong, cleaning the contacts is one of the most beneficial maintenance actions that a person can do for the computer. The problem I have is with the use of an eraser. A pencil eraser is highly abrasive to the contacts, as Ron notes in the article ("you can see the scratch marks on the contacts").

Having had to work on a computer system (PDP 11/70) where an eraser to the contacts was the normal maintenance action for a period of about two years, I can tell you that really bizarre glitches and lockups will occur when the protective tin or gold coating is erased down to the base copper material. It doesn't take too many erasings to erase away the tin coating, and a lot less to erase away gold plating.

Any contacts bearing gold should NEVER be erased. The gold plating is there because gold doesn't oxidize. which is the cause of problems to begin with. Silver and tin/lead (solder coated) do oxidize. Without the availability of a good commercial cleaner and anti-oxidizing lubricant, a person should use alcohol and a lint-free cloth to clean card edge contacts. If your contacts are either dirty or contain resistive oxides, it will be very apparent on the cloth.

The products I use both at work and at play are the Cramolin line from Caig
(See Page 10)

NEW LOW PRICE \$4.95 each

DEMO DISKS

SECOND SERIES \$4.95 each +s&h

DATA BASE DEMO DISK

This data program is one of the best we have ever seen. Fast, easy to use, and a price that can't be beat. This program was written by Tom Nichols who is a professional programmer. He wrote it to keep track of the many articles in each the various computer magazines he received each month. He would simply enter the article by category (i.e. hardware), Publication, Date and Title and comment and any time he wanted to refer to the material he could find it. In fact it even does a fast search for a key word. The version we supply as a demo disk has a over a hundred articles entered so you can learn to completely use it before you delete this data and enter you own. Unprotected so it can be modified for specific applications. This could easily be the only data base program you ever need.

ASTROLOGY DEMO DISK

This professional quality program is as good as the ones we have seen on the coin operated machines. Beautiful color graphics. You enter your birth date and learn your horoscope, sign, and historical facts about your birthdate. One of the best freeware programs we have seen. Great for setting up at a charity event or party.

WILL WRITER DEMO DISK

This program does just what the title says. It asks you a group of questions and then automatically writes a last will and testament. Now you can leave your TI-99/4A to your favorite nephew. Works with any printer and appears to be legal in all states but of course that should be checked out.

ENGINEERING CALCULATIONS

This two sided disk contains dozens of the most often used technical formulas and crunches out the answer when you enter your data. Easy to use and very fast and accurate. For example, you enter the power and voltage you need and it will design you a power supply complete with circuit. Even does medical laboratory calculations and cable television frequency conversions. A must for anyone whose job or hobby involves scientific calculations.

TI DISK MANAGER 2 BACKUP

Your worries are over. This critical module which is only available by mailing a defective one back to TI in Texas, is now available on disk. This is the actual TI Disk Manager 2 Module on a disk with exbasic autoloader. Once loaded, the disk can be removed and the manager resides in memory while you utilize its features on your disks i.e. cataloging, copying, formatting, etc. In providing this disk as a backup to your module we act as your agent. For legal reasons, it is only available as a backup to those who own the original module and by ordering it you represent and warrant to us that you do and that we are authorized to make this backup for you as your agent. Supports single and double sided/single density drives.

MEDICAL ALERT DEMO DISK

This disk contains many menu accessible files covering most everyday medical emergencies such as poisoning, broken bones, heart attacks and shock. Like all our demo disks, it contains many valuable features that can be used on other programs. It also can be easily updated although it appears as complete as a "what to do until the doctor arrives" guide can be.

R RATED GAME DEMO DISK

It had to happen. A talented programmer in Germany sat down and programmed a complete "Invaders" style space game with great color graphics except the gun and flying targets are not what you would find at your neighborhood arcade. A great party gag game and fantastic exbasic programming. One of the best use of sprites we have seen. You must be over 18 to order this one.

KIDS LEARNING DISK DEMO

A collection of educational programs for younger children compiled by a professional educator. Two disk sides of programs with menu selected autoloading on each side.

TEXCOMP

P.O. BOX 33064 - GRANADA HILLS, CA 91344



AUTHORIZED DEALER

LOADERS AND CATALOGERS

A collection of programs that load and catalog other programs. If you want a bunch of programs on a disk and have all autoloader from a menu selection, this disk is for you. If you want to catalog a disk and see the files on screen or print out a hard copy on any printer, this disk is for you. We included a collection of the best. Just transfer the loader program you like to a formatted disk under the name LOAD and you are in business.

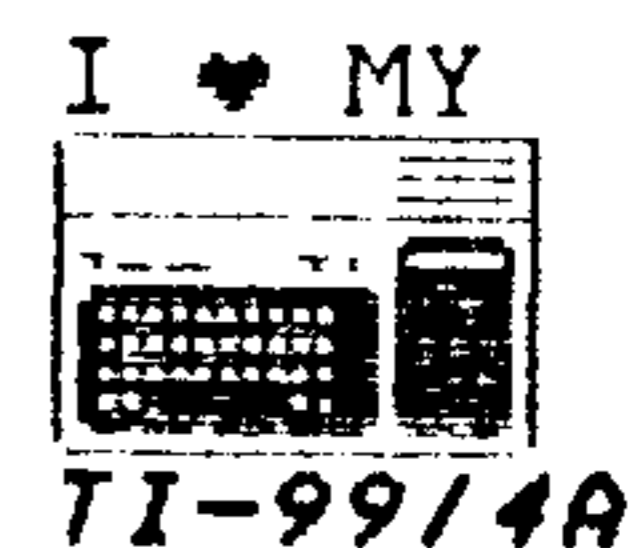

LABEL MAKER DEMO DISK

This program lets you make custom three line labels by just entering in the three lines you want and pressing enter. The labels will then be printed on tractor drive labels with a graphic display of the TI-99/4A console. Epson compatibility required for graphic display. Also prints multiple labels. Great for disks, mail and business.



MOST DISKS REQUIRE EXBASIC

TEX-COMP CONTINUES TO OFFER THE BEST IN PUBLIC DOMAIN AND FREWARE DISKS AT THE LOWEST POSSIBLE PRICE. WE CONTINUE TO REVIEW THE HUNDREDS OF PROGRAMS THAT HAVE BEEN CREATED FOR THE TI-99/4A AND CONTINUE TO SELECT ONLY THE BEST AND OFFER THEM AT A PRICE EVERYONE CAN AFFORD. WE DO NOT OFFER ANY PROGRAM THAT WE WOULD NOT WANT IN OUR OWN COLLECTION.



VISA and MASTERCARD
HOLDERS CALL DIRECT
(818) 366-6631
24 Hour Order Line

TERMS: All prices FOB Los Angeles. For fastest service use cashiers check or money order. Add 3% shipping and handling (\$3.00 Minimum). East of Mississippi 4 1/2%. Add 3% for Credit Card orders. Prices and availability subject to change without notice. We reserve the right to limit quantities.

NOTE: Payment in full must accompany all orders. Credit card. Company check or Money order for immediate shipment. Personal Checks require up to 4 weeks to clear. California orders add 6 1/2% sales tax.

Feedback

(Continued from Page 8)

Laboratories (1175-0 Industrial Ave., P.O. Box J, Escondido, CA 92025-0051). Their Cramolin products not only clean the contacts, but they also preserve (anti-oxidants) and lubricate. While not as good a bargain as alcohol, it is a much better product.

While on the subject, I have heard it mentioned more than once that if you have a soldering iron you can clean the contacts by re-flowing the solder. While this may be acceptable if a good flux is used with minimum iron heat, and the flux is removed with a good quality flux remover, it is not advised to do so unless contact wear has become excessive, as the glue that holds the copper to the circuit board has a mean tendency to disintegrate under too much heat.

William Borchardt
El Paso, Texas

Delphi messages requested

I have recently been granted access to Delphi. My user name is (most cleverly) BETTINELLI.

I will surely appreciate receiving messages from Geneve and TI99 owners.

Norberto R. Bettinelli
Buenos Aires, Argentina

A Checksum program that checks

In the October 1987 issue of MICROpendium, Tom Freeman describes a combined XBASIC and assembly utility, used to provide checksum tags for BASIC. While the idea is just as good as it's old, there is one thing I don't agree with.

On page 28, Mr. Freeman says: "...probability approaching zero, that a small number of mistakes will result in a number that differs by exactly 256 or a multiple thereof. The one exception is that if you transpose two characters, there's nothing I can do about that."

The number he refers to is the checksum tag. Here, two things can be noticed.

First, of all the various errors the average user is guilty of when entering programs, or anything else for that matter, the most common is transposing two characters.

Second, there is certainly something to do about it. I'm the editor of a column called "Utmaningen" (The Challenge) in the Swedish newsletter Programbiten, published by the user group with the same name. As a result of a challenge, Mr. Lars Thomasson wrote a checksum program. Being both a listing and a checksum utility, it's used in a different way compared to Freeman's program, but the point is that it will sense transposed characters!

How is this done? Well, once you know it, it's very simple. Instead of merely adding all byte values together, you first multiply them by their position in the program line. There are, of course, still different lines that yield the same checksum, mostly due to the reduction in range of the checksum, but the error trapping capability is greatly enhanced.

With the source code available, it shouldn't be too difficult to change the current checksum program. I consider the improvement important enough to motivate a quick change, even considering that it will not be compatible with the current listings.

Anders Persson
Lund, Sweden

More on printouts

In response to Shirley Slicer (Feedback Feb. 1988) who is getting "good printouts using TI-Artist and the (Seikosha) GP550 printer," the difference seems to be in the change from the GP550A (which is no doubt the Slicer printer) to my GP550TI. In my case, using Ms. Slicer's parameters, what begins on the screen as a circle elongates vertically in the printer to an oval. Changing her line spacing value (8) to a 4 produces (roughly) a circle, but the image quality suffers. Texaments has of course not said that TI-Artist works with the GP550TI.

Perhaps one time in 10 the program prompts for "Density Factor." When that happens, the printout is wild and unpredictable, no matter how I set the program. Both this "Density Factor" and, as Ms. Slicer has observed, Magnification #3 are faulty, at least on my disk. I use TI-Artist occasionally; not every image must be in proportion. Most fonts can be twice as tall and still look well enough.

Also in the February issue was a letter

from the Texaments TI-Artist representative, Stephen Lamberti, who had the good news that there is indeed a cursor speed control in this program, and "function semicolon" toggles back and forth between slow and fast. Thank you, Mr. Lamberti! (I also got this information from someone who called Woody Large, sysop in Sacramento, who in turn called me.)

And then there was the earlier advice of Rick Fallstrom in October '87, who felt that I should sell the GP550TI and buy one of the newer "SP" series at maybe \$150.

All these with my best interests at heart! It's much appreciated.

Elton Schooling
Sacramento, California

(Actually, Stephen Lamberti's letter was only one of several received containing the same information on this topic.—Ed.)

Tutorial error

I want to thank you for publishing Bob Carmany's review of my KWIKFONT source code/tutorial disk. Since its publication I have been swamped with requests for the floppy. Sometimes the lonely TI user gets the feeling that he is the only one using a 99/4A anymore, but the response I have received has certainly convinced me otherwise.

I would like to point out an error in FILE2 of the tutorial concerning the six header bytes of a memory image file (EA5). The second pair of bytes gives the number of bytes to load, and the third pair of bytes indicates the CPU RAM address to which the file is to be moved. For some reason I inadvertently wrote exactly the opposite.

Wayne Stith
Richmond, Virginia

The Feedback column is for readers. It is a forum to communicate with other readers. The editor will condense excessively lengthy submissions where necessary. Mail Feedback items to: MICROpendium, P.O. Box 1343, Round Rock, TX 78680.

Coming next month

- Adding a mouse to your TI
- Review of 32K Super Space

TEXCOMP™**PRESENTS:****DEMO DISKS****SPECIAL!! ONLY \$4.95 each +s&h****NEW LOW PRICE \$4.95 each**

A NOTE ABOUT DEMO DISKS: TEX-COMP's demo disks are a collection of disks containing unique and entertaining features which we believe will help you get more out of your TI-99/4A. Some if not all of them are in the public domain. However, in certain cases, the author requests a contribution if you use and enjoy it. While you are not legally obligated to do so, we at TEX-COMP encourage your assisting these talented programmers if you enjoy their work. That is why we offer these disks at such a low price.

"THE SINGING TI-99/4A"**SPEECH & MUSIC DEMO DISK**

This is the disk everyone is talking about. The computer voice actually sings to animated graphics. Created by master programmer Ken Gilliland, it includes the now classic Bert & Ernie routine, Matilda and much much more. 32K, ExBasic, Speech Syn required.

WHEEL OF FORTUNE, BLACKJACK, AND JOKER POKER

Three fantastic freeware programs one disk by a great exbasic programmer, Terry Staph. Professional quality and the best "wheel" program at any price.

DUMPIT DEMO DISK

This disk helps you transfer programs from many TI modules to disk. Recommended only for users with some programming knowledge and use of ExBasic and Ed/Assem. Instructions are included on disk on VAR 80 file.

PRINTART DEMO DISK

This two sided disk is a collection of programs that print out pictures of near photographic quality on most printers. Many familiar TV and comic characters are on this disk.

ORIGINAL TI-99/4A SALES DEMO DISK WITH TI-TREK GAME

This disk is packed full of demo programs that were supplied to original dealers such as TEX-COMP by TI. Contains demos of graphics, speech, personal record keeping and games. Includes documentation and TI-TREK, a great computer game that talks. Speech and TE-II required. on some programs.

TI MUSIC/GRAPHICS DEMO DISK

Contains a great collection of music and matching animated graphics. Great examples of music and sprite programming.

EXBASIC MUSIC DEMO DISK

A collection of beautiful arrangements of popular hits. Includes a great exbasic catalog/loader program that can be used on your other disks.

SPACE SHUTTLE MUSIC/GRAPHICS DEMO DISK

One of the finest examples of TI-99/4A programming that we have seen. A long running epic saluting our space program. This is one disk you will run over and over again. A must for every TI-99/4A owner. Wonderful examples of graphics, music, and successive file access and display.

LOTTO DEMO DISK

This program randomly selects numbers for typical lotto games and even runs a simulated game. Easy to modify for a specific game like pick six. Great disk for fun and learning random number generation features in programming.

MONA LISA PRINT OUT

Now you can print out a fantastic likeness of this classic with the seductive smile. We understand that it was made by digitizing a video scan of the original on another computer and converting the code to run on the TI-99/4A. Everyone who sees the printout is impressed.

GOTHIC PRINT DEMO DISK

This disk lets you type out a message and then print it out in a fancy gothic type style that looks like hand lettered calligraphy. Great for making invitations, announcements, and business cards. A great learning disk as are all demo disks offered by TEX-COMP.

ANIMATED CHRISTMAS CARD

A wonderful example of computer graphics and animation by master programmer Ray Kazner. Loaded with programming features that you will use over and over.

TI-99 OLOPY DEMO DISK

This great piece of programming actually simulates and plays the famous board game. For legal reasons we cannot give out the name of the original game but "do not pass go...go directly to jail".

STRIP POKER (PG RATED)

Play poker against your 99/4A. When you win a hand, she loses...a piece of her clothing with a surprise ending.

FIGURE STUDY DEMO DISK (PG RATED)

This disk contains a collection of files that print out Playboy type centerfolds. Use with any printer.

STAR/EPSON PRINTER DEMO DISK

A disk that contains a large collection of files and programs that put your Star or Epson compatible printer through its paces. You can list out any program to see how the various text and graphics were created. A great learning tool.

SIDWAYS PRINTOUT DEMO DISK

This program allows you to print out material from your printer sideways. Great for spreadsheet displays, banners etc. Can be modified for various printers.

TI FORTH DEMO DISK

This demo disk was distributed by TI some time back. Contains wonderful music and graphics written in forth. Requires 32K and Ed/Assem to run.

TI DIAGNOSTIC DISK

This program loads into your Mini Memory module (required) and checks out your entire TI system. Developed by TI and provided to dealers for distribution to customers. Complete documentation on second disk side.

TI WRITER/MULTIPLAN UPGRADE DISK

This disk was released by TI to upgrade your original TI Writer and Multiplan. Adds a number of features to TI Writer including real lower case. Also speeds Multiplan up.

IMPORTANT DEMO DISK NOTICE: All demo disks sold by Tex-Comp have been reviewed and determined to offer valuable educational and entertainment features to the user. There is no warranty or guarantee that they are free from bugs and most likely are not although we are not aware of any. Certain of these disks may include a claim of copyright from the author with the right to distribute at no charge expressly or impliedly granted providing the ultimate user pays a suggested amount or in some cases an amount that the user feels is fair. Tex-Comp encourages that payment to the author of a reasonable amount be made when requested. Tex-Comp will review any program for inclusion in this demo disk program however the final decision is that of Tex-Comp. Be sure that a request for payment is on the screen display and that any documentation is in the program or on the disk such as a "read this" text file preferably menu accessible from exbasic. Send any disks for consideration to Tex-Comp Demo Disk Program, P.O. Box 33084, Granada Hills, CA 91344. Disk cannot be returned and become the property of Tex-Comp. All submitters warrant and represent that the software submitted is their property.

Send order and make checks payable to:

TEX-COMP

P.O. Box 33084, Granada Hills, CA 91344



AUTHORIZED DEALER

VISA and MASTERCARD
HOLDERS CALL DIRECT**(818) 366-6631**

24 Hour Order Line

TERMS: All prices FOB Los Angeles. For fastest service use cashiers check or money order. Add 3% shipping and handling (\$3.00 Minimum). East of Mississippi 4 1/4%. Add 3% for credit card orders. Prices and availability subject to change without notice. We reserve the right to limit quantities.

NOTE: Payment in full must accompany all orders—credit card, company check or money order for immediate shipment. Personal checks require up to 4 weeks to clear. California orders add 8 1/4% sales tax.

BASIC

Signed numbers, more or less

By REGENA

Recently I was helping my daughter with an algebra assignment and I realized that she really didn't understand the basics of combining positive and negative numbers or signed numbers. The program this month is a tutorial and practice unit for learning about signed numbers or reviewing some beginning algebra concepts.

The first time a student runs this program, he or she would choose the main menu choices in numerical order. The first section is "Number Line." The number line concept is shown with examples, then problems for the student to solve. First, positive numbers on the number line are used, then negative numbers are introduced.

The second section is "Adding Numbers," which is adding numbers using the number line. First, two positive numbers are added. The next step is to add a positive number and a negative number. Then the first number is negative and a positive number is added to it. Finally, two negative numbers are added.

The third major section is "Subtracting Numbers." Instruction and example screens are printed showing how to combine positive and negative numbers by subtraction. Different combinations of positive and negative numbers in subtraction are presented in the problems.

When a problem is presented for addition or subtraction, if any answer is incorrect, the solution is shown and the student is given a similar problem. If the answer is correct, the student has the option of having another similar problem or continuing the program.

Line 120 uses the DEF statement to define a function R(X) to be a random number from 1 to X. Notice that later in the program, random numbers can be chosen by using a statement such as B=R(7). Subroutines are used for groups of statements that are used more than once.

Lines 100-220 print the title and define characters and colors used to draw lines and points and to label the number lines. Lines 230-240 define two strings that are used to draw the number lines. To type the symbols in the quotes, use the FCTN key and U for the underline and the FCTN key and Z for the backslash. These two symbols are redefined to draw the number lines. L\$ uses two underlines between each backslash, and L2\$ uses one underline between each backslash.

Lines 250-370 print the main menu screen, receive the student's response, and branch appropriately. After a section is completed, the program returns to Line 350, then branches back to Line 250 to print the main menu screen again.

Lines 380-1350 contain a number of subroutines which are used in various places (more than once) in the program. Lines 380-430 are the subroutine to wait for the student to press the ENTER key before the program continues. Lines 440-550 contain four different subroutines to print the different kinds of number lines. Lines 560-620 present the option to see another example or to continue the program. Lines 630-690 present the option to have another problem of the same kind or to continue the program.

Lines 700-730 are the subroutine that plays the sounds for an incorrect answer. FLAG is a variable used to indicate an incorrect answer so the same kind of problem can be repeated. Lines 740-780 are the subroutine that plays the sounds for a correct answer. Lines

790-890 are the subroutine to show how to get the correct answer. The first point is plotted on the number line, then the second point is added or subtracted. The variable C is the column number. F is a factor that is +1 for addition and -1 for subtraction. A, AI, B, and BI are the numbers used in the problem. A is a number used to plot the point on the number line, and AI is the actual number for the problem. B is the absolute value of the second number chosen, and BI is the signed number.

Lines 900-1090 are the subroutine to get the student's answer. Lines 940-1040 are the section to get the + or - sign, and Lines 1050-1080 are the section to get the number. CALL KEY is used rather than INPUT so the screen graphics can be preserved. Lines 1100-1140 are the subroutine for the procedure when an answer is incorrect. The incorrect "uh-oh" is sounded, then the problem solution is shown graphically on the number line. The student must then press the ENTER key to continue. Lines 1150-1180 are the subroutine for the procedure when an answer is correct. The correct point is plotted on the number line, an arpeggio is played, and the option to have another problem or to continue is presented.

Lines 1190-1220 are the subroutine for adding numbers. The total T is the sum of the numbers AI and BI. Lines 1230-1260 are the subroutine for subtracting numbers. The total T is BI subtracted from AI.

Lines 1270-1350 are the subroutine to move the point for the second number. After the first number is placed, the point is moved one unit at a time for the second number, and a red point is placed for the final answer.

Lines 1360-2410 are the major subroutine for "Number Line." Lines 1360-1460 show an example, then Lines 1470-1640 present a problem. A point is shown on the number line and the student must type in the number represented. Lines 1650-1730 show an example of a negative number on the number line. Lines 1740-2070 present the problem and the student gives the number represented by the given point. Lines 2080-2410 give a number and the student must use the arrow keys to place the point on the number line.

Lines 2420-3490 are the major subroutine for "Adding Numbers." Lines 2420-2610 present an example. Lines 2620-2970 give a problem for adding two positive numbers. Lines 2980-3120 give an example for adding a positive number and a negative number. Lines 3130-3240 present a problem for adding a positive number and a negative number. Lines 3250-3360 present a problem for adding two negative numbers. Lines 3370-3490 present a problem for adding a negative number and a positive number.

Lines 3500-4510 are the major subroutine for "Subtracting Numbers." Lines 3500-4010 print examples. Lines 4020-4140 present a problem of subtracting a positive number from a positive number. Lines 4150-4260 present a problem of subtracting a negative number from a positive number. Lines 4270-4380 present a problem of subtracting a positive number from a negative number. Lines 4390-4510 present a problem of subtracting a negative number from a negative number. Line 4530 ends the program.

If you prefer to save typing effort, you may have a copy of this program by sending \$3 copying fee plus a blank cassette or diskette and a stamped, self-addressed mailer to REGENA, P.O. Box 1502, Cedar City, UT 84720. Please be sure to specify that you need the TI version of "Signed Numbers" as published in MICROpendium.

(See Page 14)

THE GENEVE 9640 HAS LANDED

You will recognize it by its trade mark, a graceful gray swan swimming on blue water, an apt symbol. The ugly duckling TI no longer wanted, is no ugly duckling anymore. The GENEVE has surpassed everyone's expectations, even our own; with power, speed, graphics, and adaptability not found in other microcomputers. In fact, the GENEVE does so much, this ad can only begin to tell you about it.

- **Near 100% Compatible:**

- If you have a program written in Basic, Extended Basic, XBI, Assembly Language, Forth, Pascal, you name it, if it runs on the 99/4A then it is near certain to run on the GENEVE.

- **32K No Wait State High Speed RAM:**

- Programs like MultiPlan, which are painfully slow on the 99/4A, run many times faster, thanks in part to the High Speed RAM.

- **V9938 Video Processor with 7 Graphics Modes:**

- Compatible with the 99/4A so you can use the GENEVE with the TV or monitor you are currently using. Same resolution as the Mac but with color. Faster than the Amiga, as fast as the Atari and does it with true aspect ratio, something the Amiga and IBM AT can not do. Aspect ratio renders higher resolution, better color, and appearance, through the use of square pixels. In the high resolution mode, 256 colors may be displayed on the screen at one time by the GENEVE, eight times as many as the Amiga can display in its high resolution mode.

- **Mouse Interface:**

- The mouse interface is built in and ready to use with the MYARC mouse. But, we didn't stop there, it is also ready to support the newest hardware, like video digitizers, and that's just for starters.

- **6 Complete Pieces Of Software Are Included With The GENEVE. But, three you will not be able to see how you ever did without are:**

- My-Word Processor; 80 columns, help screens for all modes of operation including control-U, initialize a disk without leaving the program, print formatted text to the screen for viewing before sending it to the printer and that's still not all My-Word will do.

- Advanced Basic; the best and most powerful basic on the market today.

- Pascal V4.21; if you have a standard USCD Pascal program, you will be able to run it with this program. If you do not have any Pascal programs, let me tell you, one of the largest library of programs available, is Pascal. Compilers for Fortran, Modula 2, Lisp, and Pilot, as well as business programs from A to Z, are all there. USCD Pascal Software developed for computers from Apple to IBM, will run on the GENEVE, without modification.

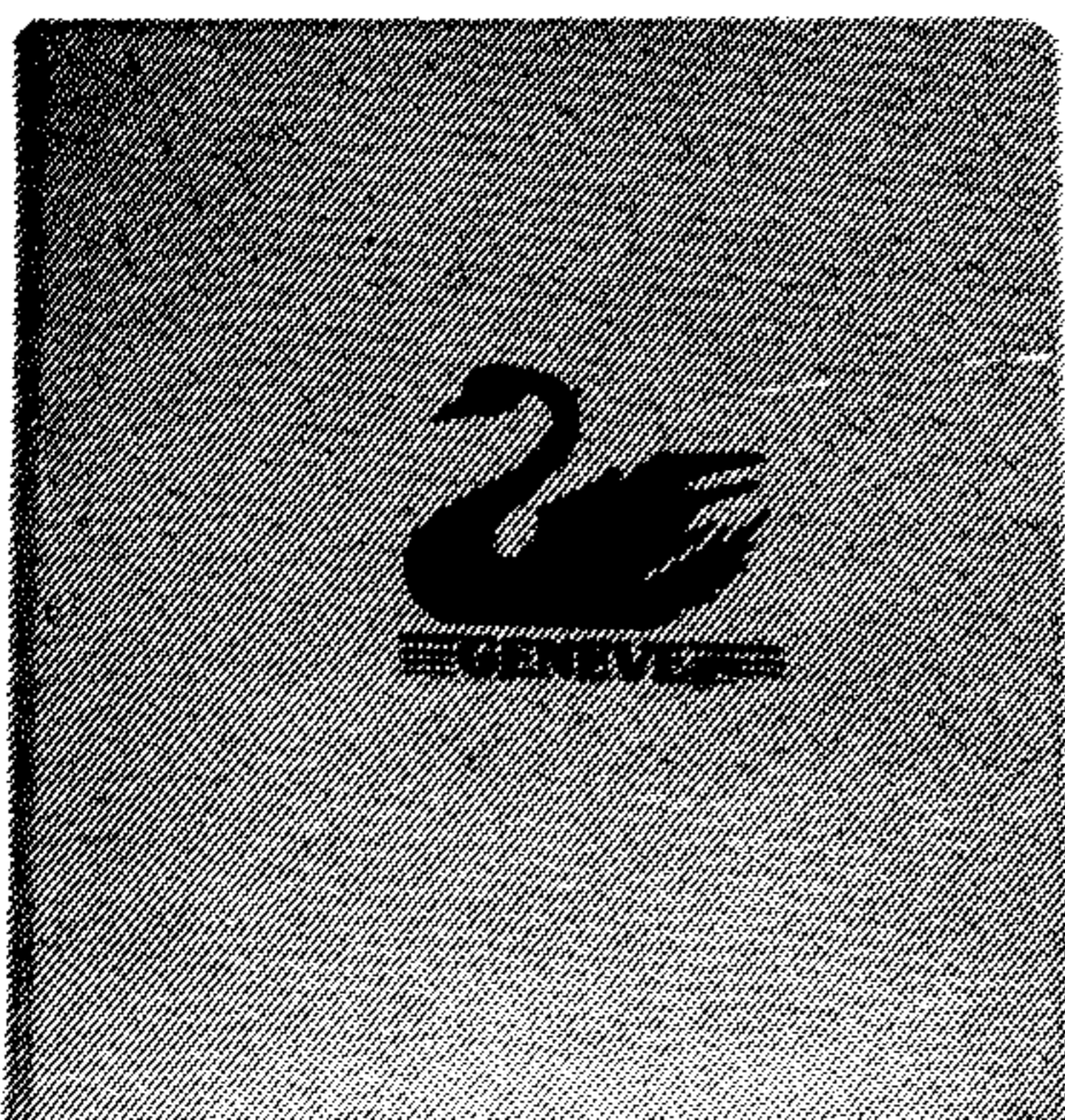
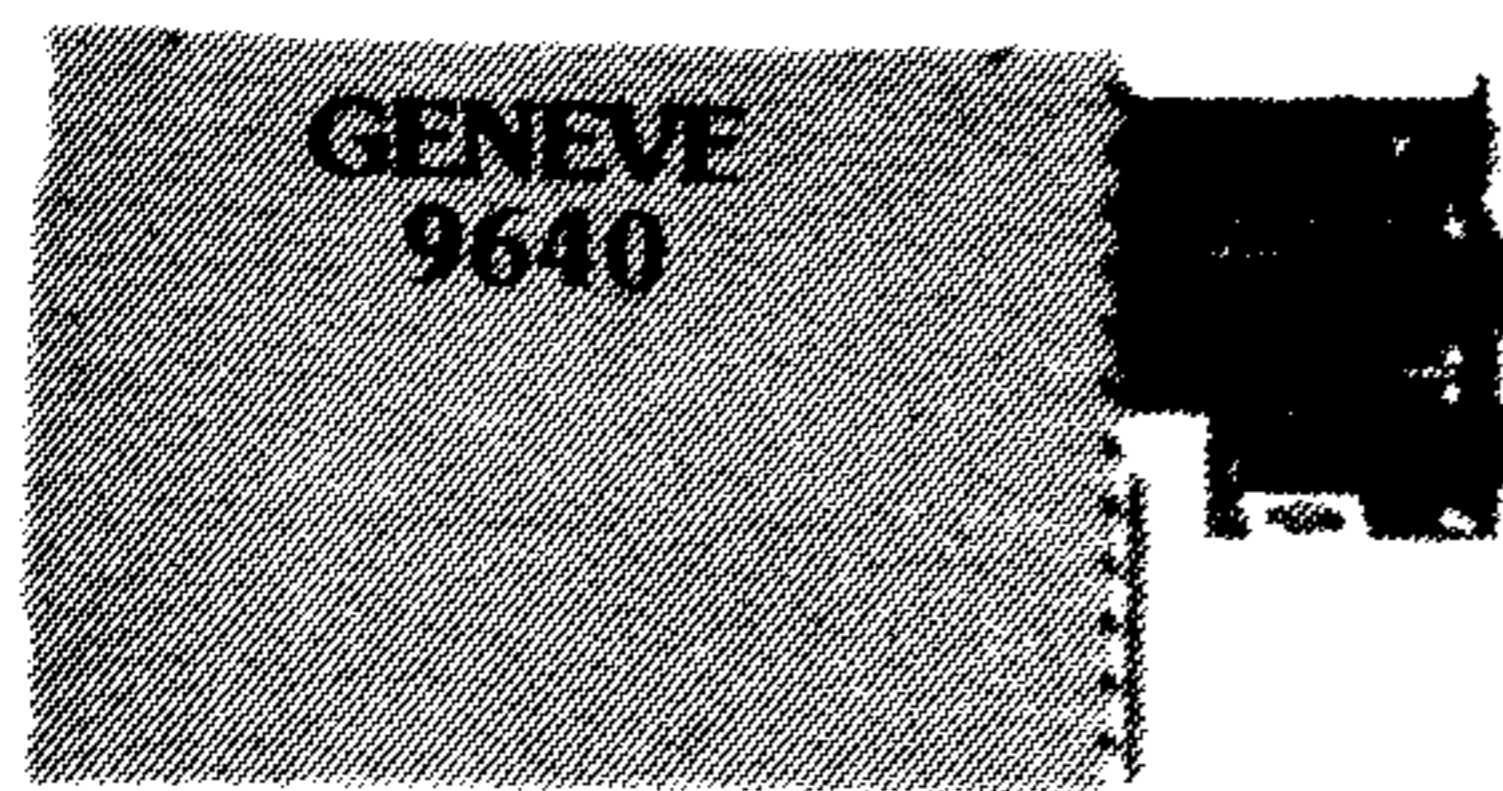
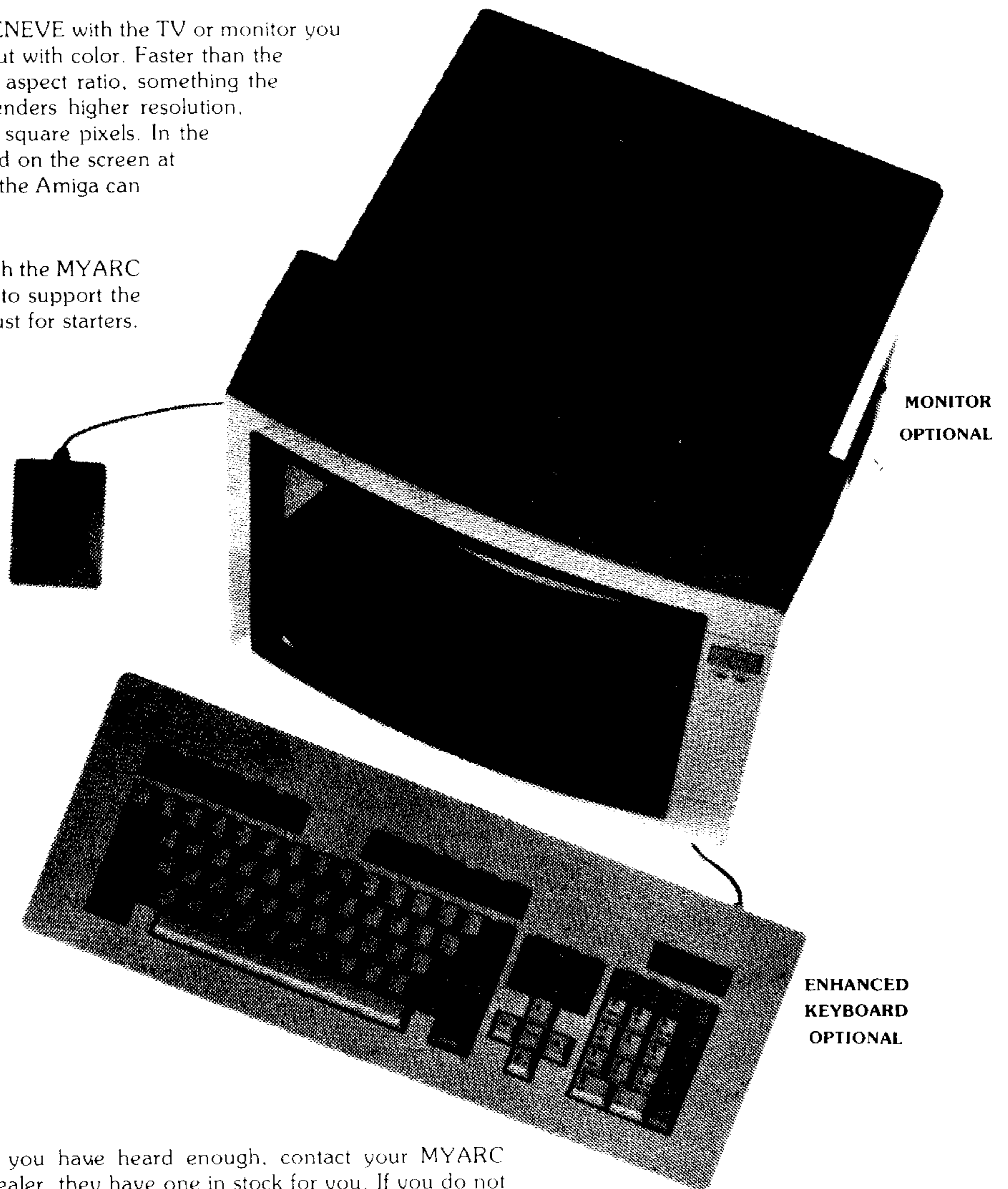

If you have heard enough, contact your MYARC dealer, they have one in stock for you. If you do not know who your stocking MYARC dealers are, or, if you want to know more about the GENEVE, telephone the number listed below, or mail your name and complete address with zip code to the address shown below. We will be happy to mail you a brochure covering the GENEVE in detail and a list of our stocking dealers. Supplies of the brochure are limited, so please hurry.

GENEVE
P. O. Box 140
Basking Ridge, New Jersey 07920-1014
(201) 766-1700

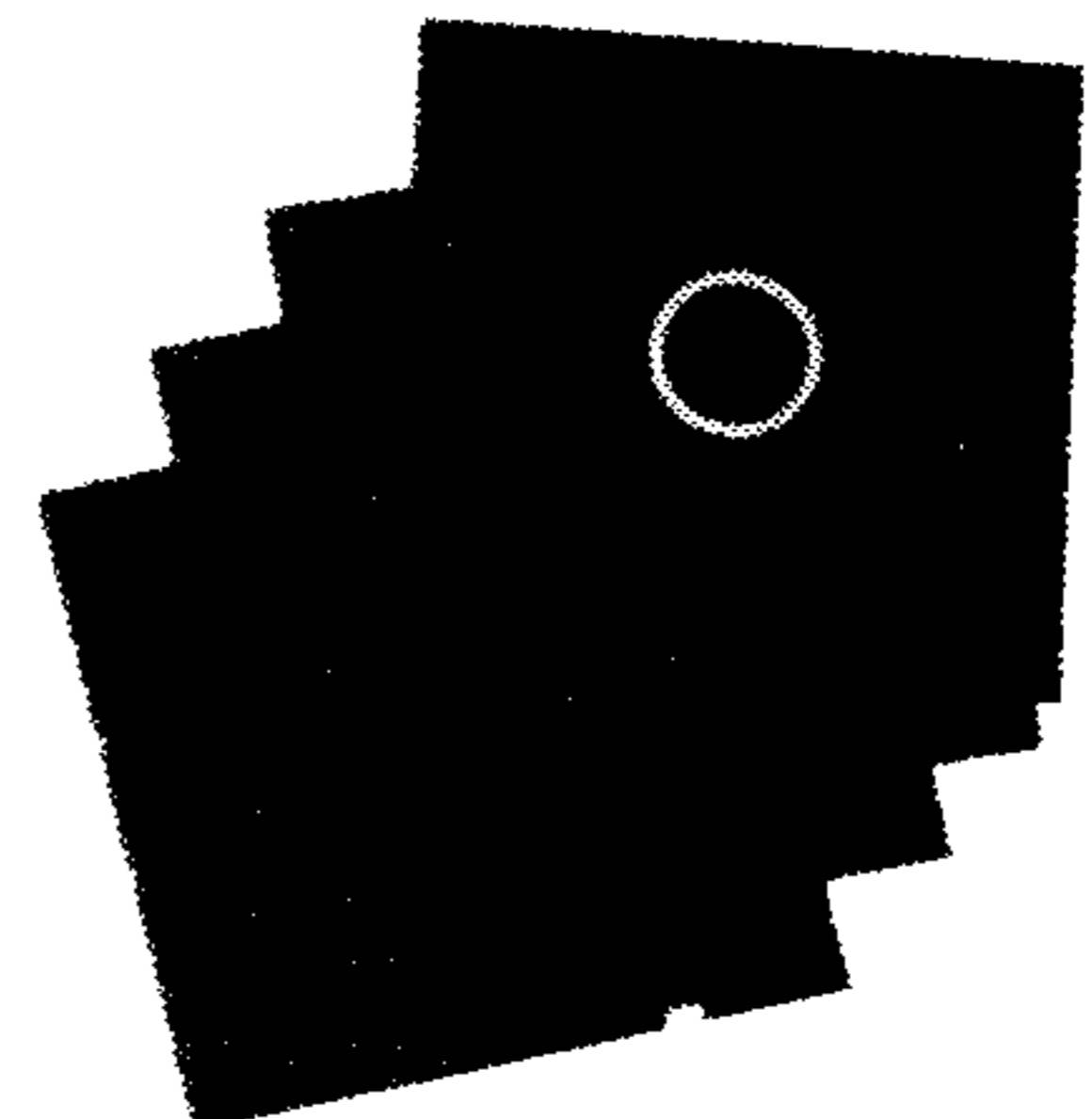



112 RAMBLING ROAD
VERNON, CT 06066

(203) 871-7824

ADD 5% FOR HANDLING AND SHIPPING.
CT. RESIDENTS ADD 7.5% SALES TAX.



VISA & Master Card Add 3%



INTRODUCES.....

RAVE 99 MEMORY
ENHANCEMENT SYSTEM

Need a memory card? Buy the one that can be expanded as your needs change. Think MX01!!! Not enough room to fully describe system. Call or Write for more Details!!

NEW!

The NEW Memory Enhancement Card allows memory expansion for the TI-99/4A up to 544K bytes of backedup memory. Up to FOUR (4) memory cards may be installed in the PEB which allows access to over 2 MEGABYTES of BACKED-UP memory. o Three Models Available

- ** Model MX01/64 - \$199.95 Includes
8K BYTES of memory at >6000 -> >7FFF
8K BYTES Non-DSR Memory, 8K BYTES System DSR Memory, 8K BYTES User DSR Memory, 32K BYTES Main Memory, ONLY VERY Low-Power Memories are used, Advanced Memory Backup Design
Expansion sockets to increase memory to 544K.
- ** Model MX01/288 - \$299.95 Same as MX01/64 W/256K of main memory
- ** Model MX01/544 - \$399.95 Same as MX01/64 W/512K of main memory

MODEL 99/105 KEYBOARD ENHANCEMENT

THE FOLLOWING ARE STANDARD FEATURES ON THE MODEL 99/105 KEYBOARD ENHANCEMENT...

- * * INTERFACE LOGIC CARD WHICH INSTALLS EASILY IN CONSOLE WITHOUT SOLDERING. **\$199.95**
- * * 105 KEY KEYBOARD WITH 24 FUNCTION KEYS.
- * * SUPPORTS SINGLE KEY ENTRY OF ALL TI-WRITER, MULTIPLAN, AND EDITOR/ASSEMBLER COMMANDS.
- * * ATTRACTIVE LOW PROFILE KEYBOARD WITH ADJUSTABLE TILT ANGLE AND 5 FT. CORD.
- * * DEDICATED NUMERIC KEYPAD WITH NUMERIC OPERATORS.
- * * DEDICATED CURSOR CONTROL KEYS. **INCLUDES custom keyboard.**
- * * ENLARGED RETURN, SHIFT, AND CONTROL KEYS.
- * * OPTIONAL USER INSTALLED RESET AND LOAD INTERRUPT CAPABILITY FROM KEYBOARD.
- * * DETAILED INSTALLATION AND OPERATING INSTRUCTION MANUAL INCLUDED.

KEYBOARD INTERFACE CARD - \$149.95

- * * Interface card installs in 4A console in place of old keyboard and allows use of any IBM PC/XT compatible keyboard with your 99/4A. Interface card supports all 83 standard PC/XT key codes.
- * * Comes with complete, easy to follow installation and operating instructions. NO SOLDERING REQUIRED.
- * * Optional user installed RESET and LOAD INTERRUPT capability from keyboard. Complete instructions included.



KIT AVAILABLE

- * * Includes printed circuit board, complete instruction manual, and RAVE 99 custom chips. Hard to find hardware also included. Requires only assembly \$ 92.00 and about \$10.00 in easy to find components to complete.

* IBM & PC/XT are trademarks of International Business Machines

SPEECH SYNTHESIZER ADAPTER CARD

- * * Finally, A low cost method to move your TI-Speech synthesizer from the side of the console to the Peripheral Expansion Box (PEB)
- * * Takes only minutes to remove the housing from your speech synthesizer and install into the P.E. Box.
- * * Compatible with the 99/4A and 9640 GENEVE computers.
- * * Software Compatible with TI-Speech Synthesizer.
- * * High Quality Construction, 90 Day Warranty
- * * LOW COST .. \$49.95 + \$2.50 for Shipping & Handling
- * * Units are in stock and ready for immediate delivery.
- * * Make someone happy, Put a "voice" back in your computer!!

NEW!

BASIC—

(Continued from Page 14)

```

177
1290 C=C+CC !139
1300 CALL HCHAR(ROW,C,104)!0
62
1310 CALL SOUND(1,9999,30)!1
57
1320 CALL HCHAR(ROW,C,92)!01
9
1330 NEXT J !224
1340 CALL HCHAR(ROW,C,104)!0
62
1350 RETURN !136
1360 PRINT "** NUMBER LINE *
*" !109
1370 GOSUB 440 !009
1380 PRINT "POSITIVE NUMBERS
ARE TO THE RIGHT OF ZERO."
!217
1390 PRINT : : "HERE IS AN EX
AMPLE" !154
1400 RANDOMIZE !149
1410 A=R(8)!191
1420 GOSUB 440 !009
1430 PRINT "NUMBER: ";A !131
1440 CALL HCHAR(19,3*A+5,104
)!246
1450 GOSUB 560 !130
1460 IF K=49 THEN 1390 !176
1470 CALL CLEAR !209
1480 B=R(9)-1 !125
1490 FLAG=0 !209
1500 GOSUB 440 !009
1510 CALL HCHAR(20,3*B+5,104
)!239
1520 PRINT : "WHAT IS THE NUM
BER?": : !174
1530 CALL SOUND(200,440,2)!1
29
1540 CALL KEY(0,K,S)!187
1550 IF (K<48)+(K>56) THEN 15
40 !034
1560 CALL HCHAR(22,24,K)!076
1570 IF K-48=B THEN 1610 !14
4
1580 GOSUB 700 !014
1590 CALL HCHAR(22,24,32)!04
8
1600 GOTO 1540 !089
1610 GOSUB 740 !054
1620 IF FLAG=1 THEN 1470 !14
6
1630 GOSUB 630 !200
1640 IF K=49 THEN 1480 !010
1650 PRINT "NEGATIVE NUMBERS
ARE SHOWN TO THE LEFT OF Z
ERO." !059
1660 GOSUB 470 !039
1670 PRINT "HERE IS AN EXAMP
LE." !095
1680 GOSUB 470 !039
1690 A=R(9)!192
1700 CALL HCHAR(20,3*A+2,104
)!235
1710 PRINT "NUMBER = ";A-5 !
103
1720 GOSUB 560 !130
1730 IF K=49 THEN 1670 !201
1740 CALL CLEAR !209
1750 FLAG=0 !209
1760 GOSUB 470 !039
1770 A=R(9)!192
1780 CALL HCHAR(20,3*A+2,104
)!235
1790 PRINT "WHAT IS THE NUMB
ER?" !143
1800 CALL SOUND(100,440,2)!1
28
1810 S$="" !252
1820 IF A=5 THEN 1940 !149
1830 CALL HCHAR(23,24,43)!05
1
1840 CALL HCHAR(23,24,45)!05
3
1850 CALL KEY(0,K,S)!187
1860 IF (K=43)+(K=61)+(K=45)
+(K=47)<>-1 THEN 1830 !074
1870 IF (K<>61) THEN 1900 !21
6
1880 K=43 !058
1890 GOTO 1920 !214
1900 IF K<>47 THEN 1920 !131
1910 K=45 !060
1920 CALL HCHAR(23,24,K)!077
1930 S$=CHR$(K)!195
1940 CALL KEY(0,K,S)!187
1950 CALL HCHAR(23,25,63)!05
4
1960 CALL HCHAR(23,25,32)!05
0
1970 IF (K<48)+(K>52) THEN 19
40 !175
1980 CALL HCHAR(23,25,K)!078
1990 S$=S$&STR$(K-48)!239
2000 IF VAL(S$)=A-5 THEN 204
0 !121
2010 GOSUB 700 !014
2020 CALL HCHAR(23,24,32,2)!
223
2030 GOTO 1810 !104
2040 GOSUB 740 !054
2050 IF FLAG=1 THEN 1740 !16
1
2060 GOSUB 630 !200
2070 IF K=49 THEN 1740 !015
2080 CALL CLEAR !209
2090 PRINT "USE THE ARROW KE
YS TO MOVE THE POINT, THEN
PRESS aENTER" !156
2100 A=R(9)!192
2110 FLAG=0 !209
2120 PRINT : : "LOCATE THE
NUMBER ";A-5: : !042
2130 GOSUB 470 !039
2140 C=17 !051
2150 ROW=20 !226
2160 CALL HCHAR(ROW,C,97)!04
4
2170 CALL HCHAR(ROW,C,92)!01
9
2180 CALL KEY(0,K,S)!187
2190 IF K=13 THEN 2300 !056
2200 IF (K<>83)+(K<>68)=-2 T
HEN 2160 !140
2210 IF K=68 THEN 2260 !026
2220 C=C-3 !002
2230 IF C>4 THEN 2160 !117
2240 C=5 !255
2250 GOTO 2160 !199
2260 C=C+3 !001
2270 IF C<30 THEN 2160 !164
2280 C=29 !054
2290 GOTO 2160 !199
2300 CALL HCHAR(ROW,C,97)!04
4
2310 B=(C-2)/3 !045
2320 IF A=B THEN 2370 !137
2330 GOSUB 700 !014
2340 CALL HCHAR(ROW,A*3+2,10
4)!183
2350 GOSUB 380 !205
2360 GOTO 2080 !119
2370 GOSUB 740 !054
2380 IF FLAG=1 THEN 2350 !04
6
2390 GOSUB 630 !200
2400 IF K=49 THEN 2080 !101
2410 RETURN !136
2420 PRINT "** ADDING NUMBER
S **" !066
2430 F=1 !254
2440 PRINT : : "TO ADD TWO NU
MBERS, YOU" !015
2450 PRINT "COMBINE THEM." !
233
2460 PRINT : "HERE IS AN EXAM
PLE." !020

```

(See Page 18)

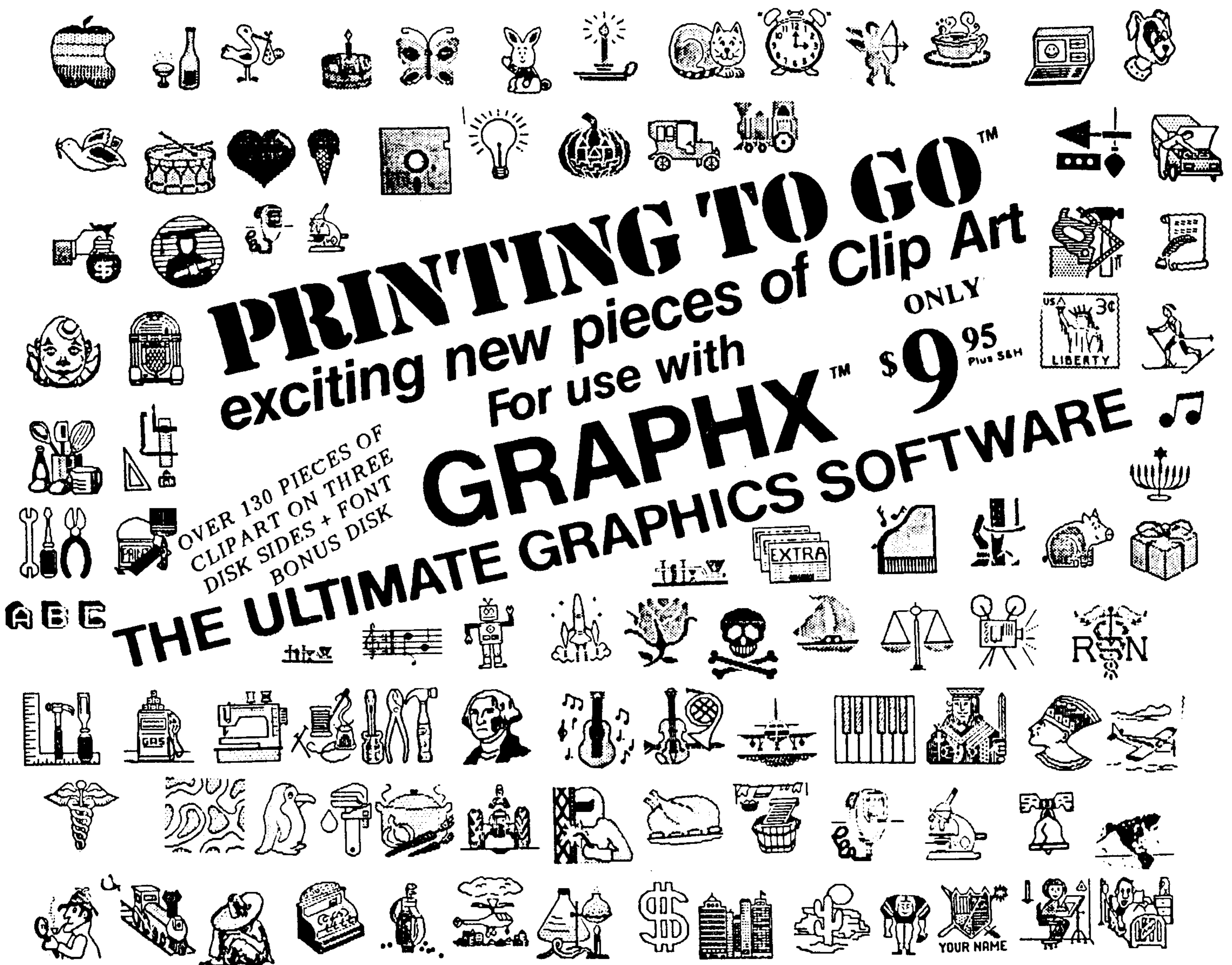

PRINTING TO GO™
 exciting new pieces of Clip Art
 For use with

GRAPHX™ \$9.95 PLUS S&H
THE ULTIMATE GRAPHICS SOFTWARE

OVER 130 PIECES OF
 CLIPART ON THREE
 DISK SIDES + FONT
 BONUS DISK

ABC

ABC

\$

ABC

C
B
A

PRINTING TO GO is a great collection of clip art to add to your *graphx* software. *Graphx* continues to be the most supported of all TI-99/4A graphics programs and by far the best value. This collection comes on three disks and as a bonus we add still another disk of fonts (alphabet letters and numbers) not previously offered for *Graphx*. All for one low price of \$9.95 +s&h. The complete *GRAPHX* starter package with the *Graphx* program and a bonus disk (two sides) of clip art and fonts is \$19.95 +S&H. Also available is *Graphx* Companion Disks I-IV from Asgard, a collection of great clipart and fonts-\$24.95- (seven disk sides.) With *GRAPHX* and the great collection of clipart and fonts available you have virtually every thing you need to prepare advertising, newsletters, T-Shirts, banners, stickers, invitations and greeting cards and the list goes on and on.....

Send order and make checks payable to:

TEX+COMP

P.O. BOX 33064 - GRANADA HILLS, CA 91344



AUTHORIZED DEALER



VISA and MASTERCARD
 HOLDERS CALL DIRECT
(818) 366-6631
 24 Hour Order Line

TERMS: All prices F.O.B. Los Angeles. For fastest service use cashiers check or money order. Add 3% shipping and handling (\$3.00 Minimum). East of Mississippi 4 1/2%. Add 3% for Credit Card orders. Prices and availability subject to change without notice. We reserve the right to limit quantities.

NOTE: Payment in full must accompany all orders. Credit card, Company check or Money order for immediate shipment. Personal Checks require up to 4 weeks to clear. California orders add 6 1/2% sales tax.

BASIC—

```

(Continued from Page 16)
2470 GOSUB 500 !069
2480 RANDOMIZE !149
2490 A=R(6)!189
2500 B=R(6)+1 !121
2510 PRINT "ADD";A;"AND";B !
107
2520 PRINT : "FIRST LOCATE";A
!121
2530 C=A*2+4 !190
2540 CALL HCHAR(17,C,97)!082
2550 PRINT : "THEN MOVE TO TH
R RIGHT FOR ";B;"UNITS." !12
2
2560 CC=2 !063
2570 ROW=14 !229
2580 GOSUB 1270 !074
2590 PRINT : "THE ANSWER IS";
A+B !170
2600 GOSUB 560 !130
2610 IF K=49 THEN 2460 !226
2620 CALL CLEAR !209
2630 A=R(6)!189
2640 B=R(6)+1 !121
2650 PRINT "ADD";A;"AND";B !
107
2660 T=A+B !086
2670 T$=STR$(T)!210
2680 L=LEN(T$)!196
2690 GOSUB 500 !069
2700 PRINT "WHAT IS THE ANSW
ER? -";!186
2710 IF L=1 THEN 2730 !181
2720 PRINT "-";!069
2730 PRINT !156
2740 C=23 !048
2750 S$="" !252
2760 FOR J=1 TO L !139
2770 CALL KEY(0,K,S)!187
2780 IF S<1 THEN 2770 !229
2790 IF (K<48)+(K>57)THEN 27
70 !245
2800 CALL HCHAR(23,C+J,K)!10
7
2810 S$=S$&CHR$(K)!242
2820 NEXT J !224
2830 IF VAL(S$)=T THEN 2940
!084
2840 GOSUB 700 !014
2850 PRINT : "START WITH";A !
001
2860 C=A*2+4 !190
2870 CALL HCHAR(17,C,97)!082
2880 PRINT : "MOVE";B;"UNITS"
!092
2890 ROW=15 !230
2900 GOSUB 1270 !074
2910 PRINT : "THE ANSWER IS";
A+B !170
2920 GOSUB 380 !205
2930 GOTO 2620 !149
2940 CALL HCHAR(19,T*2+4,104
)!007
2950 GOSUB 740 !054
2960 GOSUB 630 !200
2970 IF K=49 THEN 2620 !131
2980 CALL CLEAR !209
2990 PRINT "FOR A POSITIVE N
UMBER" !060
3000 PRINT "MOVE TO THE RIGH
T." !060
3010 PRINT : "FOR A NEGATIVE
NUMBER" !209
3020 PRINT "MOVE TO THE LEFT
." !232
3030 A=R(7)+6 !126
3040 B=R(5)+1 !120
3050 A1=A-7 !051
3060 B1=-B !053
3070 PRINT : "ADD";A1;"AND ";
B1 !163
3080 GOSUB 530 !100
3090 ROW=16 !231
3100 GOSUB 790 !105
3110 GOSUB 560 !130
3120 IF K=49 THEN 2980 !236
3130 CALL CLEAR !209
3140 PRINT "ADD + NUMBER AND
- NUMBER" !162
3150 A=R(7)+6 !126
3160 B=R(5)+1 !120
3170 A1=A-7 !051
3180 B1=-B !053
3190 GOSUB 1190 !250
3200 IF VAL(S$)=T THEN 3230
!119
3210 GOSUB 1100 !160
3220 GOTO 3130 !149
3230 GOSUB 1150 !210
3240 IF K=49 THEN 3130 !131
3250 CALL CLEAR !209
3260 PRINT "ADD - NUMBER AND
- NUMBER" !164
3270 A=R(3)+4 !120
3280 B=R(3)!187
3290 A1=A-7 !051
3300 B1=-B !053
3310 GOSUB 1190 !250
3320 IF VAL(S$)=T THEN 3350
!240
3330 GOSUB 1100 !160
3340 GOTO 3250 !013
3350 GOSUB 1150 !210
3360 IF K=49 THEN 3250 !251
3370 CALL CLEAR !209
3380 PRINT "ADD - NUMBER AN
+ NUMBER" !162
3390 A=R(6)!189
3400 B=R(6)!190
3410 A1=A-7 !051
3420 B1=B !115
3430 GOSUB 1190 !250
3440 IF VAL(S$)=T THEN 3470
!104
3450 GOSUB 1100 !160
3460 GOTO 3370 !134
3470 GOSUB 1150 !210
3480 IF K=49 THEN 3370 !116
3490 RETURN !136
3500 PRINT "** SUBTRACTING
UMBERS **" !230
3510 F=-1 !192
3520 PRINT : : "TO SUBTRACT
NE NUMBER FROM ANOTHER, YOU
MAY THINK LIKE THIS:" !106
3530 PRINT : "1 CHANGE THE S
IGN AND ADD" !086
3540 PRINT : " OR" !253
3550 PRINT : "2 GO THE OPPOS
ITE DIRECTION ON THE NUMBER
LINE." : : : !002
3560 GOSUB 380 !205
3570 CALL CLEAR !209
3580 PRINT "CHANGE THE SIGN
AND ADD" !078
3590 PRINT : : "7 SUBTRACT 4
!236
3600 PRINT : : "7 - (+4) BE
COMES 7 + (-4)" !014
3610 PRINT : "OR 7 - 4" !185
3620 PRINT : "COMBINE 7 AND
4" !240
3630 PRINT : "THE ANSWER IS :
": : : !038
3640 GOSUB 380 !205
3650 CALL CLEAR !209
3660 PRINT "USING THE NUMBER
LINE," !093
3670 PRINT : "7 SUBTRACT (+4)
" !182
3680 GOSUB 440 !009
3690 PRINT "START WITH 7" !1
76
3700 CALL HCHAR(19,26,97)!0
7
3710 PRINT : "THEN MOVE TO TH
E LEFT" !194

```

(See Page 20)

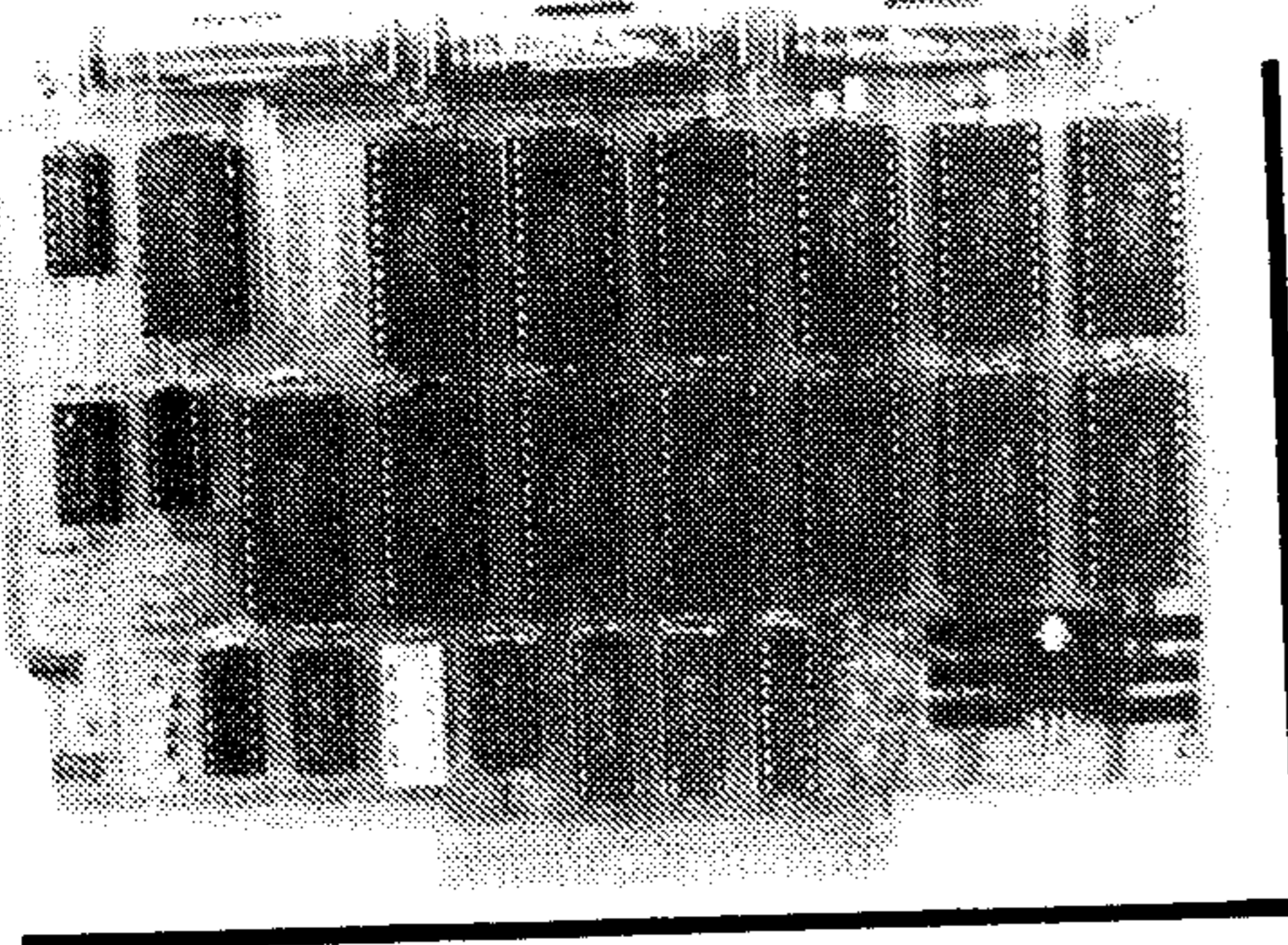

The

HORIZON RAMDISK

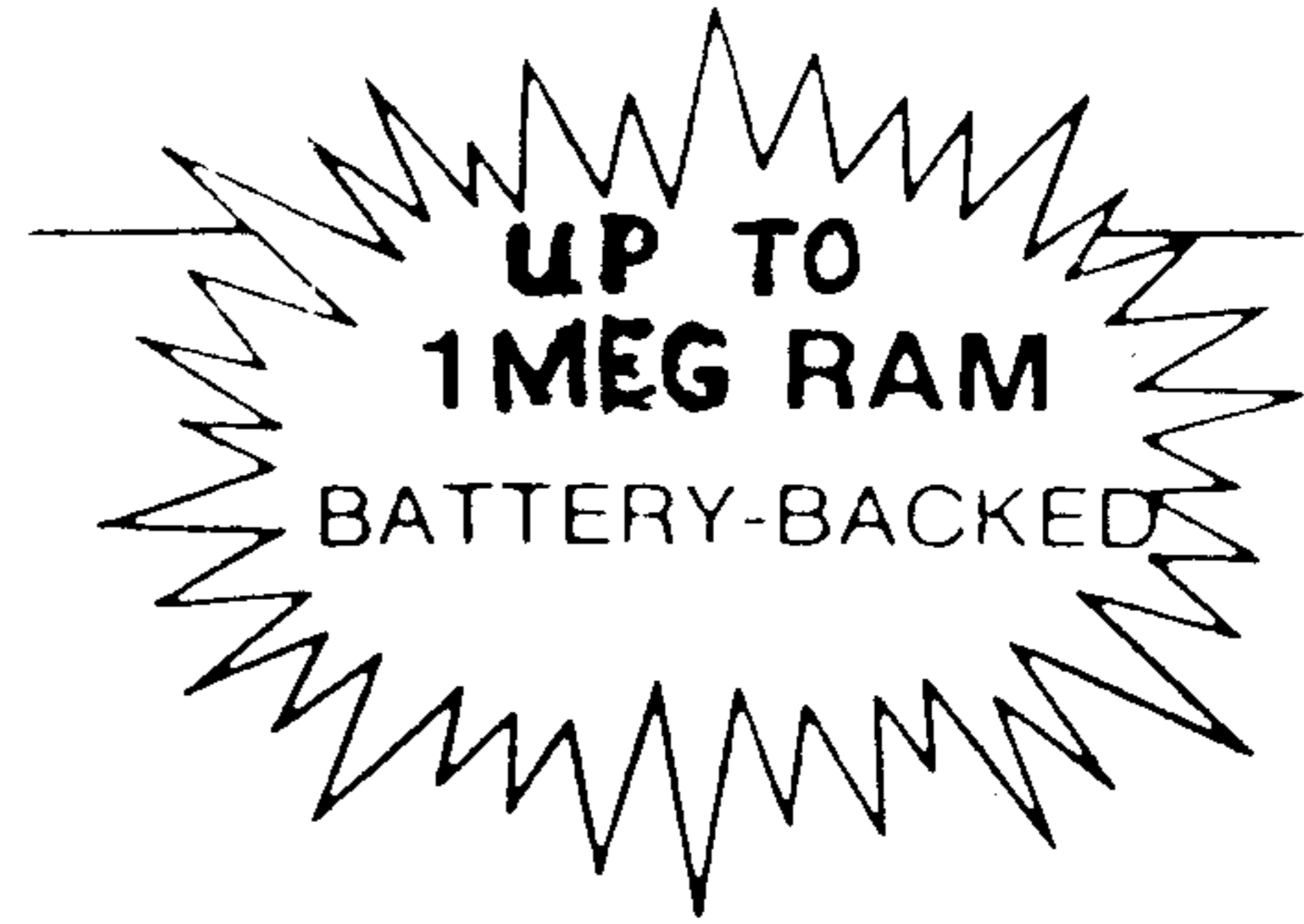

***45* PC BOARD with
MANUAL and SOFTWARE**

***38* PC BOARD only**

HORIZON COMPUTER LIMITED has been purchased by BUD MILLS SERVICES. The bare Horizon Card may still be purchased as before, but your orders should be sent to:
BUD MILLS SERVICES
166 Dartmouth Drive
Toledo Ohio 43614

ANNOUNCING THE HRD+ RAMDISK

This Ramdisk is constructed on the HORIZON Ramdisk Board using the Hitachi 62256LP12 (32K) CMOS Memory chips (or the equivalent NEC 43256LP12).

The Card is available NOW in several memory sizes- ONE+MEG, 800K (GENEVE), 512K, 384K (DSDD), 192K (DSSD), and 96K (SSSD). See attached Order Form for Prices.

The Operating System (Thanks to John Johnson and Mike Ballman of the Miami Users Group) allows the Ramdisk to be divided into TEN logical drives or less. Only two DSK (numbers) are used, the remaining drives will respond to DSK(name). The Menu program (Ver. 7.3) allows for 9 calls plus fifteen menu selections that you can edit on screen to customize the way you want it to appear - no more sector editing. XB programs can now be loaded from a call.

The HRD+ Kits include:
The HORIZONS RAMDISK BOARD
Assembly instructions
Op System and MENU Software
User Documentation
and ALL required parts.

Note: This Menu Ver. 7.3 works on ANY Horizon Ramdisk and allows BOOTING the Geneve.

Call TI-COMM BBS on 419 385 7484 for current prices or information 300 Baud, 7bit, even / 1200, 8bit, no

To BUD MILLS SERVICES
166 Dartmouth Dr.
Toledo Ohio 43614 DATE _____

From name _____
address _____
city _____ state _____
zip _____ phone () _____

Please "RUSH" my HRD+RAM kit(s)
PRE-PAID by Check or Money Order

| Quan | Type Kit | cost/ea | amt |
|------|---------------------|----------|-----|
| | HRD+RAM ONE MEG | \$435.00 | |
| | HRD+RAM 800k/GENEVE | \$375.00 | |
| | HRD+RAM 512k | \$265.00 | |
| | HRD+RAM 384k DSDD | \$225.00 | |
| | HRD+RAM 192k DSSD | \$165.00 | |
| | HRD+RAM 96k SSSD | \$140.00 | |

The above Kits include the HORIZON Card Instructions, MENU ROS and ALL parts

| | |
|--|---------|
| Bare HORIZON card | \$38.00 |
| MANUAL and SOFTWARE | \$ 7.00 |
| PHOENIX MOD to add a 90k BOOT Drive to 384 - 800k/GENEVE | \$60.00 |
| Cost to Build a Kit | \$60.00 |

Item total \$

5% discount 5 or more of each KIT

Sub-total \$

Ohio Residents add 6% sales tax

If order is under \$30 ADD \$2 S/H

will this HRD+ be used with the Geneve?? AMOUNT ENCLOSED \$

your signature X

BASIC—

(Continued from Page 18)

```

3720 PRINT "FOR 4 UNITS." !1
39
3730 C=26 !051
3740 CC=-3 !002
3750 ROW=16 !231
3760 B=4 !253
3770 GOSUB 1270 !074
3780 PRINT : "THE ANSWER IS 3
" !007
3790 GOSUB 380 !205
3800 CALL CLEAR !209
3810 PRINT "SUBTRACT A NEGAT
IVE NUMBER" !162
3820 PRINT : : "2 SUBTRACT (-
3)" !103
3830 PRINT : : "2 - (-3)" !03
7
3840 PRINT : : "CHANGE THE SI
GN AND ADD:" !243
3850 PRINT : "2 - (-3) BECOM
ES 2 + (+3)" !077
3860 PRINT : "OR 2 + 3" !177
3870 PRINT : : "THE ANSWER IS
5." !237
3880 GOSUB 380 !205
3890 CALL CLEAR !209
3900 PRINT "LOOKING AT THE N
UMBER LINE," !164
3910 PRINT : "2 SUBTRACT (-3)
" !178
3920 GOSUB 530 !100
3930 C=8 !002
3940 PRINT : "START WITH 2" !
006
3950 CALL HCHAR(18,C,97)!083
3960 PRINT : "MOVE OPPOSITE -
3 UNITS" !043
3970 CC=2 !063
3980 B=3 !252
3990 GOSUB 1270 !074
4000 PRINT : "THE ANSWER IS 5
" !009
4010 GOSUB 380 !205
4020 CALL CLEAR !209
4030 PRINT "+ NUMBER SUBTRAC
T + NUMBER": : : !108
4040 RANDOMIZE !149
4050 A1=R(6)!238
4060 B=R(7)!191
4070 A=A1+7 !050
4080 B1=B !115
4090 GOSUB 1230 !034
4100 IF VAL(S$)=T THEN 4130
!255
4110 GOSUB 1100 !160
4120 GOTO 4020 !018
4130 GOSUB 1150 !210
4140 IF K=49 THEN 4020 !000
4150 CALL CLEAR !209
4160 PRINT "+ NUMBER SUBTRAC
T - NUMBER": : : !110
4170 A1=R(3)!235
4180 A=A1+7 !050
4190 B=R(6-A1)!242
4200 B1=-B !053
4210 GOSUB 1230 !034
4220 IF VAL(S$)=T THEN 4250
!119
4230 GOSUB 1100 !160
4240 GOTO 4150 !149
4250 GOSUB 1150 !210
4260 IF K=49 THEN 4150 !131
4270 CALL CLEAR !209
4280 PRINT "- NUMBER SUBTRAC
T + NUMBER": : : !110
4290 A1=-R(3)!026
4300 A=7+A1 !050
4310 B=R(A-1)!188
4320 B1=B !115
4330 GOSUB 1230 !034
4340 IF VAL(S$)=T THEN 4370
!240
4350 GOSUB 1100 !160
4360 GOTO 4270 !013
4370 GOSUB 1150 !210
4380 IF K=49 THEN 4270 !251
4390 CALL CLEAR !209
4400 PRINT "- NUMBER SUBTRAC
T - NUMBER": : : !112
4410 A1=-R(6)!176
4420 A=7+A1 !050
4430 B=R(7)!191
4440 B1=-B !053
4450 GOSUB 1230 !034
4460 IF VAL(S$)=T THEN 4490
!104
4470 GOSUB 1100 !160
4480 GOTO 4390 !134
4490 GOSUB 1150 !210
4500 IF K=49 THEN 4390 !116
4510 RETURN !136
4520 REM BY REGINA !071
4530 END !139

```

Trials of a c99 beginner

The 'Fog Index'

By CHARLES E. KIRKWOOD JR.

Have you ever read something and found that after reading it several times you still did not understand what was written? It could have been the writer's fault (present company excepted, of course). Many of us, from time to time, have written long, rambling sentences and used "fifty-cent" words when "nickel" words would have been clearer.

The Gunning Fog Index has been a popular readability formula for over 30 years to determine the educational grade level necessary to understand 100 words of text. The formula was included in Robert Gunning's book, "The Technique of Clear Writing," published by McGraw-Hill in 1952. The formula is:

$$fi = .4 \times (av + wl),$$

where fi is the fog index, av is the average number of words per sentence, and wl is the number of long words in this 100-word text. A long word was defined as any word with three or more syllables. Since a majority of words with 8 or more letters have 3 or more syllables, a close enough approximation can be obtained by counting

the number of letters in a word rather than the number of syllables. Words with 8 or more letters which are formed by adding the suffixes *s*, *es*, *ed*, or *ing* are not counted as long words if the base word has less than 8 letters. Parentheses, quotation marks, and apostrophes are not counted. The hyphen is treated as a space. The number of words is determined by counting the number of spaces. Since there are no spaces following the last punctuation mark, one word is added at this point (the last word is also checked to see if it is a long word). The input text should have only one space between words and one space between sentences.

Type not less than 100 words of text, stop at the end of a sentence. When there are not exactly 100 words, the number of long words per 100 words needs to be calculated, as:

$$wl = 100 \times nwl / nw,$$

where wl is the number of long words per 100 words (or percentage of long words), nwl is the total number of long words, and nw is the total number of words.

(See Page 22)

A Full-Featured Machine Language Flight Simulator for the TI 99/4A!

FLY YOUR 99/4A BACK IN TIME WITH

NOW MARK 2!
 Much faster, many new features,
 including Red Baron adversary!

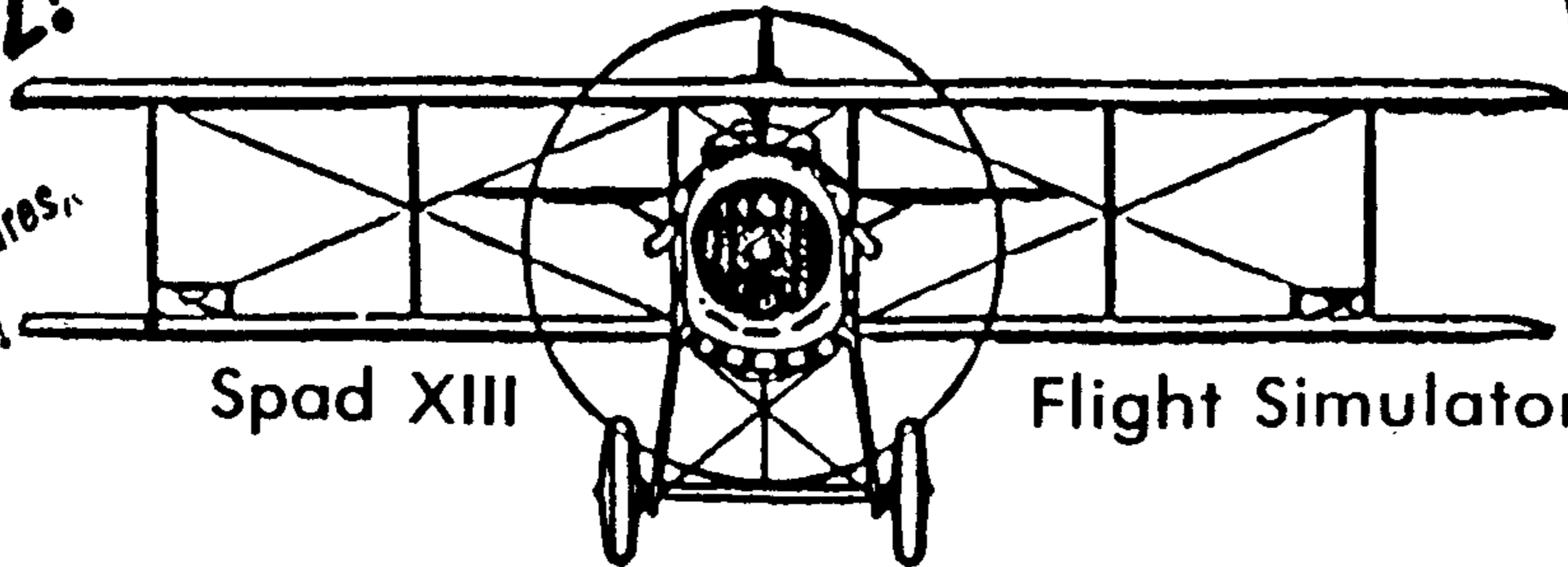

Spad XIII

Flight Simulator



ONLY
\$24.95
 Plus S&H

TRAVEL BACK IN TIME TO WORLD WAR I AND FLY THE SPAD XIII INTO AIR COMBAT. THIS ALL NEW ASSEMBLY LANGUAGE PROGRAM COMBINES GREAT FLIGHT SIMULATION WITH AN ENTERTAINING AERIAL COMBAT AND SKILL GAME.

ENGAGE IN DOGFIGHTS, BOMB ENEMY TARGETS AND EVEN FLY TO PARIS AND CIRCLE THE EIFFEL TOWER. GREAT SCENERY AND 3-D GRAPHICS. CONTINUOUS AEROBATIC CONTROL AND INSTRUMENT READOUTS. HIGHLY RATED BY MICROPENDIUM MAGAZINE (Mar 87)

(Disk drive, 32K & Exbasic required.) \$24.95 +s&h.

Tex-Comp Bonus: With each Spad XIII ordered, you receive a free copy of Games TI Plays and two disks filled with over 30 Games from this best selling book by Datamost...a \$40.00 retail value.

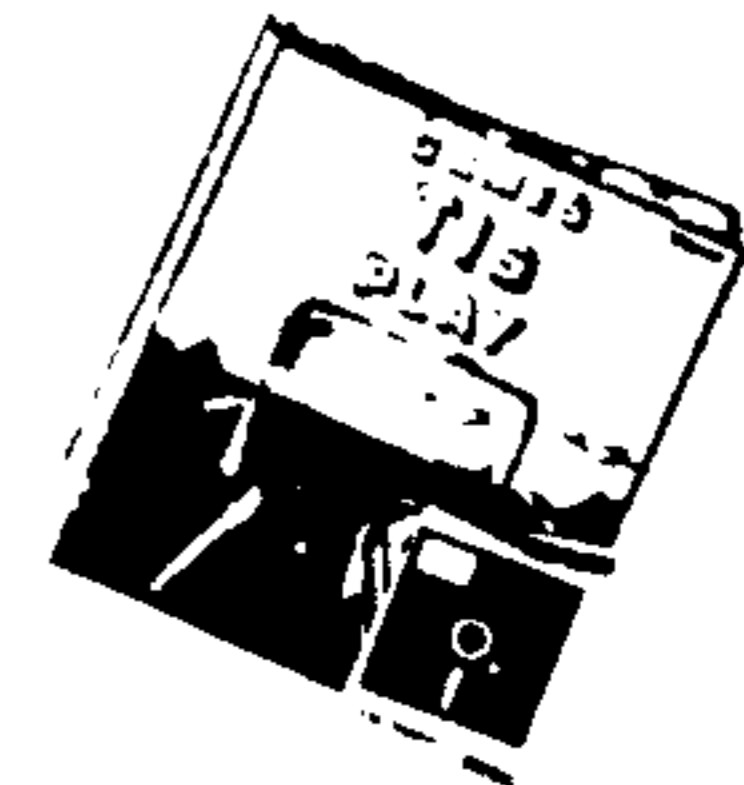

THREE GREAT GAMES

SUBMARINE COMMANDER

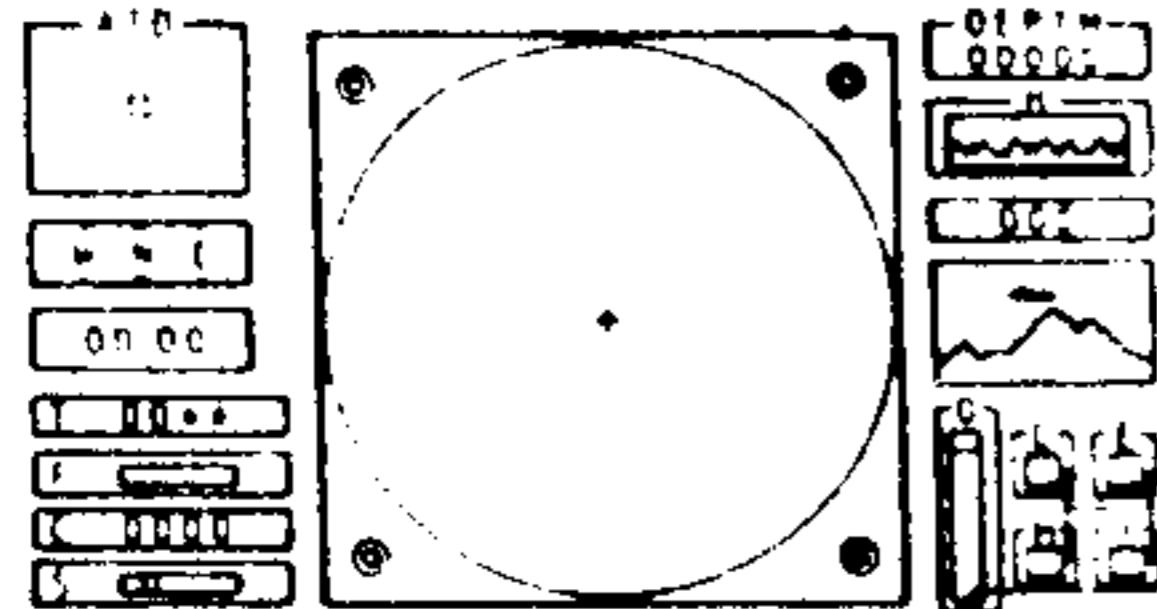

COMPUTER WAR

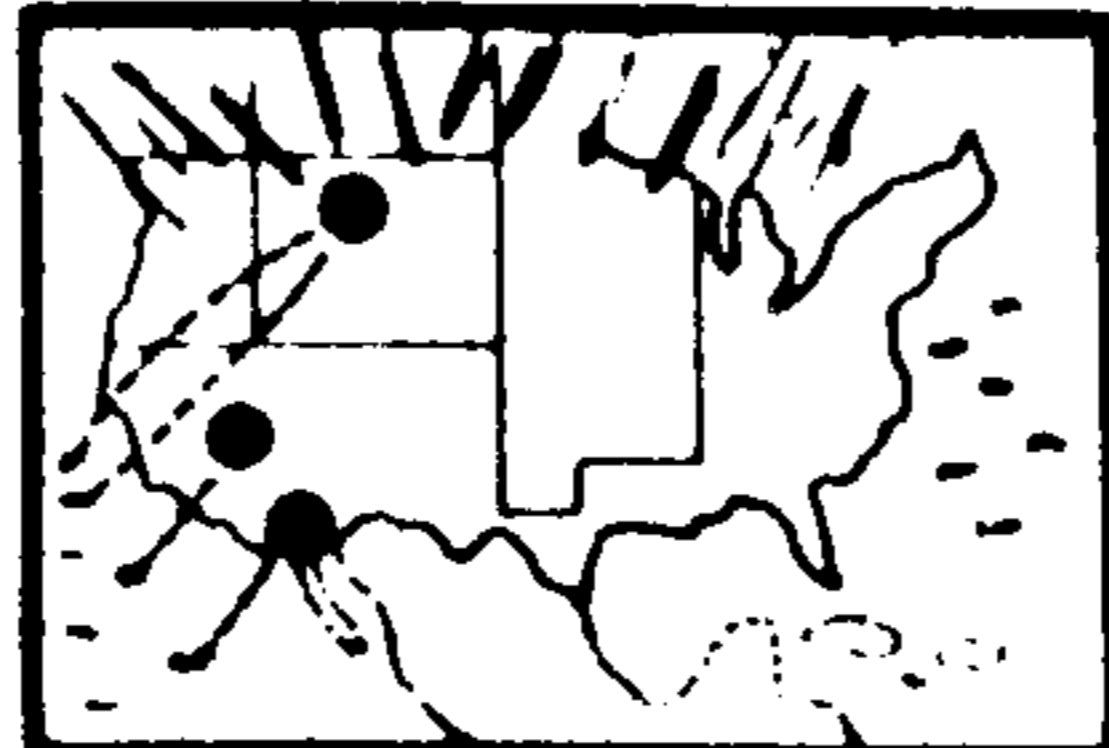

RIVER RESCUE

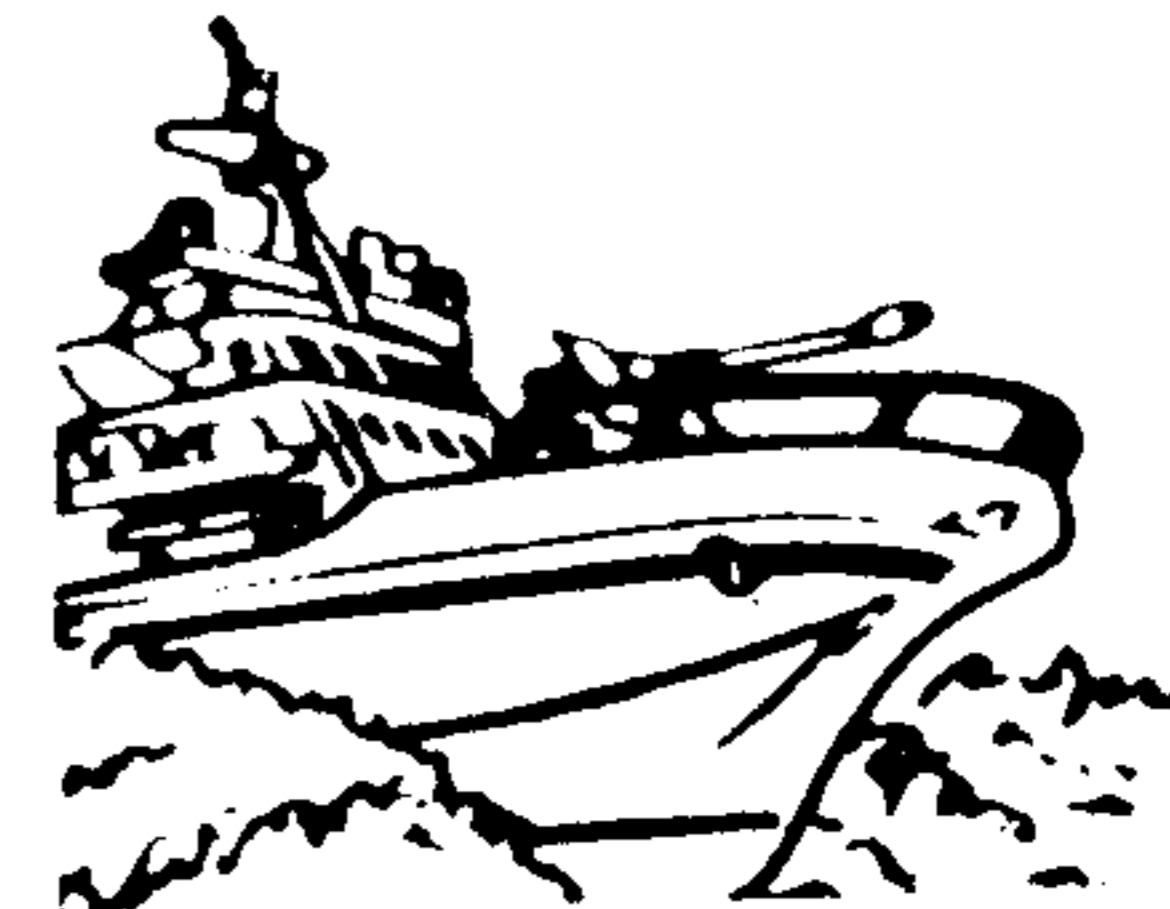

We first saw these fantastic arcade quality games in Las Vegas at a private showing in 1983. Entertainment giant Thorne EMI planned to release them on module but changed their plans. We spent over a year clearing up the rights to these games so that we could bring them to you at a great price before they were lost forever. Now you can enjoy three of the best at one great price.

\$9⁹⁵ +s&h
 ALL 3 GAMES
 ON 1 DISK

TENNIS

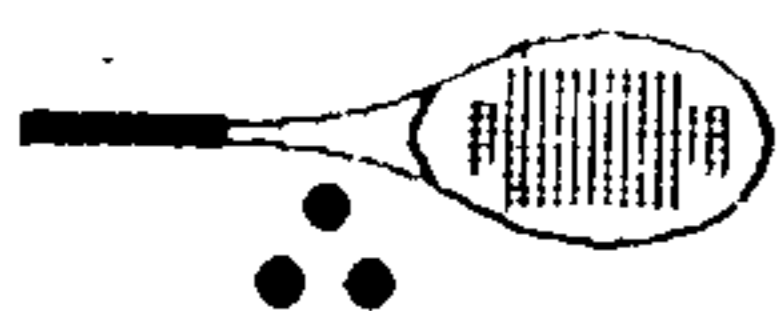

Championship Tennis lets you enjoy the excitement, action and thrills of a professional tennis match with complete control.

The graphic displays are all in dimensional perspective, which adds increased realism.

Thousands of this program have been sold throughout the world for other computers. Now, you can enjoy the ultimate action arcade game on your TI-99/4A

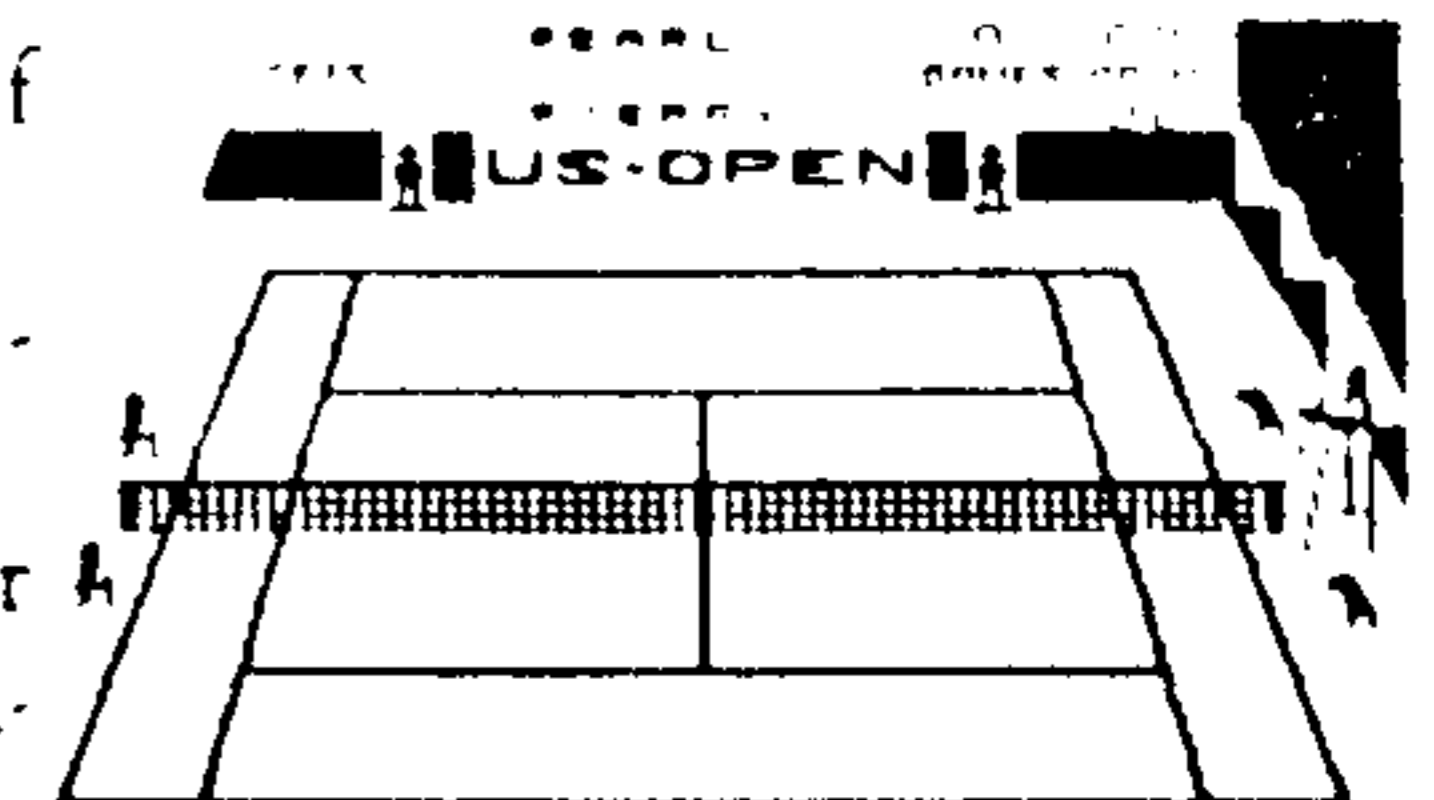

ONLY \$9⁹⁵

COMPLETE WITH DOCUMENTATION

A collection of bonus, unreleased TI arcade games are included. They may not be complete or documented, but you'll certainly have a ball with them!

Send order and make checks payable to:

TEX-COMP

P.O. Box 33064, Granada Hills, CA 91344



AUTHORIZED DEALER



VISA and MASTERCARD
 HOLDERS CALL DIRECT

(818) 366-6631

24 Hour Order Line

TERMS: All prices F.O.B. Los Angeles. For fastest service use cashiers check or money order. Add 3% shipping and handling (\$3.00 Minimum). East of Mississippi 4 1/2%. Add 3% for credit card orders. Prices and availability subject to change without notice. We reserve the right to limit quantities.

NOTE: Payment in full must accompany all orders—credit card, company check or money order for immediate shipment. Personal checks require up to 4 weeks to clear. California orders add 6 1/2% sales tax.

NEW P-BOX EXTENSION

OLD SPACE-SAVER CONNECTOR CABLE

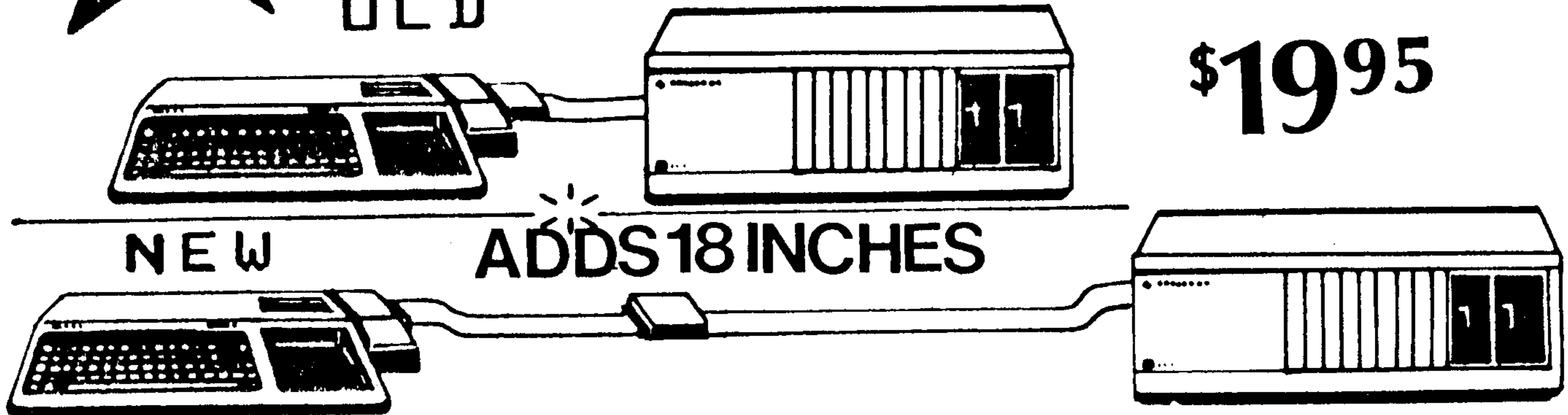

THIS NEW PRODUCT ANSWERS THE NEED MANY TI-99/4A USERS HAVE TO MOVE THE EXPANSION BOX FURTHER FROM THE CONSOLE THAN THE ORIGINAL CABLE PERMITS. IT ALSO MOVES THE HEAVY ORIGINAL TI CONNECTOR AWAY FROM THE CONSOLE WHICH IN TURN ALLOWS MORE FLEXIBILITY. UNLIKE SOME PAST ACCESSORIES OF THIS TYPE, ONLY THE HIGHEST QUALITY CONNECTORS AND TWISTED PAIR FLEX CABLE IS USED FOR RELIABLE PERFORMANCE AND LOW LOSS. THIS 18" EXTENSION CABLE ALSO LETS YOU MOVE YOUR COR COMP 9900 SYSTEM 18" AWAY FROM THE CONSOLE. GREAT FOR TIGHT QUARTERS OR TO GAIN MORE SPACE NEXT TO THE CONSOLE..... \$19.95 +s&h

Now get more out of your TI Home Computer—for less.

ADD A 2ND DISK DRIVE TO YOUR TI/99/4A SYSTEM

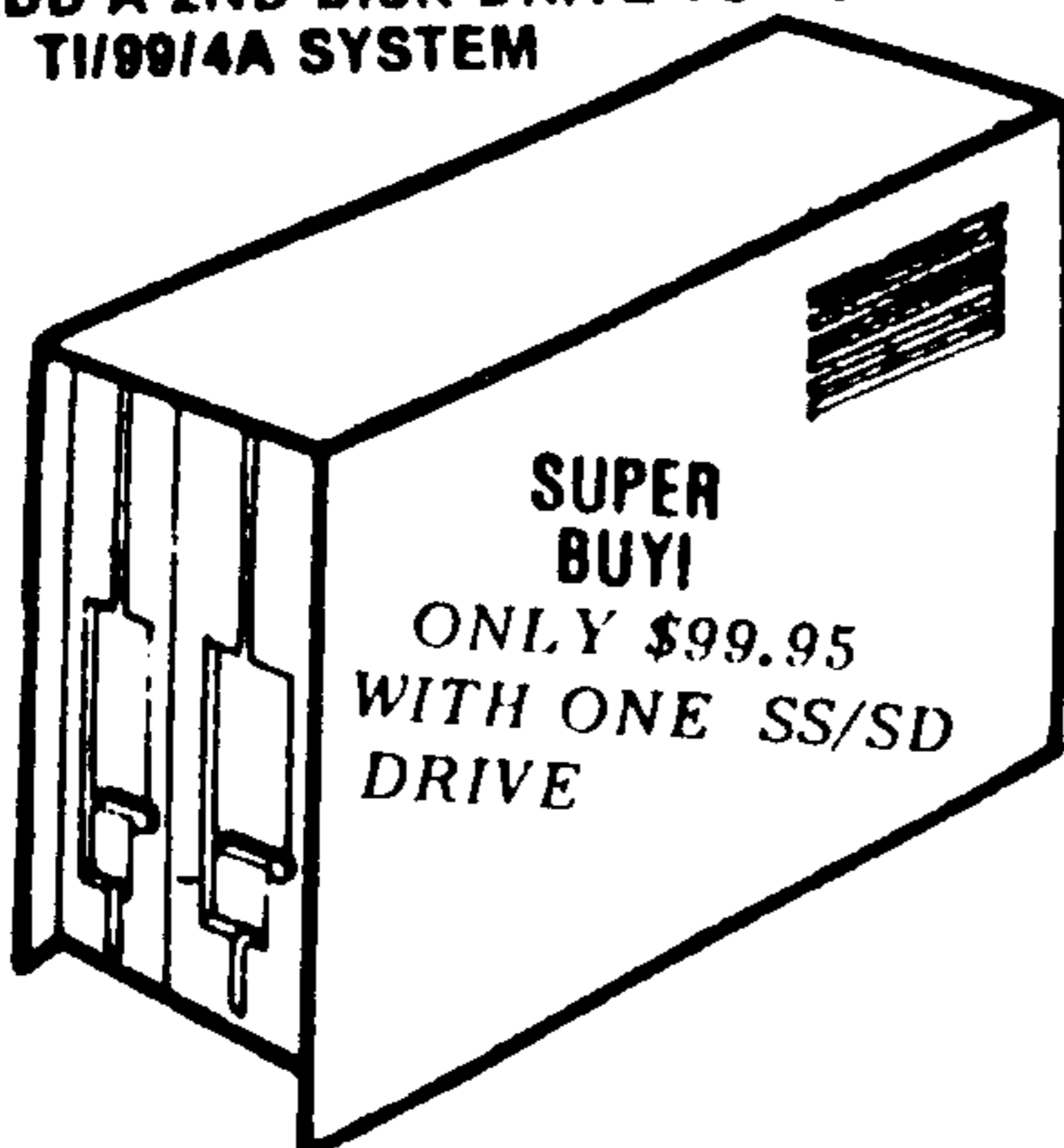

TEX-COMP BREAKS THE PRICE BARRIER ON DISK DRIVES FOR THE TI-99/4A

We made a special purchase and as always we pass our savings right on to you. NEW LOWER PRICES on all drives and stand alone drive units...Full height, half height, single and double sided and density. TI controller cards will work with single or double sided drives/single density. For double sided/double density you need the Cor-Comp controller card.

NEW LOWER PRICES!!!

- Stand alone ss/sd drive (in case with power supply and cable). \$ 99.95
- Stand alone ds/dd drive (in case with power supply and cable). \$119.95
- Half height ds/dd drives (2 will fit in P-Box.....) \$ 89.95.
- Order 2 drives and receive P-Box installation kit with all cables, bracket, screw and instructions (reg. \$29.95) for only\$ 9.95.
- Stand alone drive case with heavy duty power supply for one full size or two half height drives.....\$ 39.95.
- Specify TI P-Box or Cor Comp 9900 system when ordering stand alone drives so we can provide correct cable and instructions!
- SPECIAL original TI-99/4A ss/sd drives NEW only \$59.95..add \$20 for ds/dd.

These units are sold with a 90-day warranty.

Stand Alone Disk Drive

A Must Addition For Your System!

Cor Comp ds/dd controller card for P-Box-supports 4 drives....\$149.95

VOLKSMODEM The Complete Low-Cost Plug-In Modem.

It puts computer-to-computer communications within easy reach of every personal computer owner.

Just plug Volksmodem between any wall phone jack and telephone and put your computer into instant communication with thousands of others. It's that easy. No extra parts or tools are necessary—just one adapter cable and software is all that's needed.

MONEY SAVING SPECIAL. Get the Volksmodem (reg. \$59.95), 99/4A modem cable (reg. \$12.95), and Terminal Emulator II (reg. \$9.95) an \$80+ value for ONLY \$39.95.

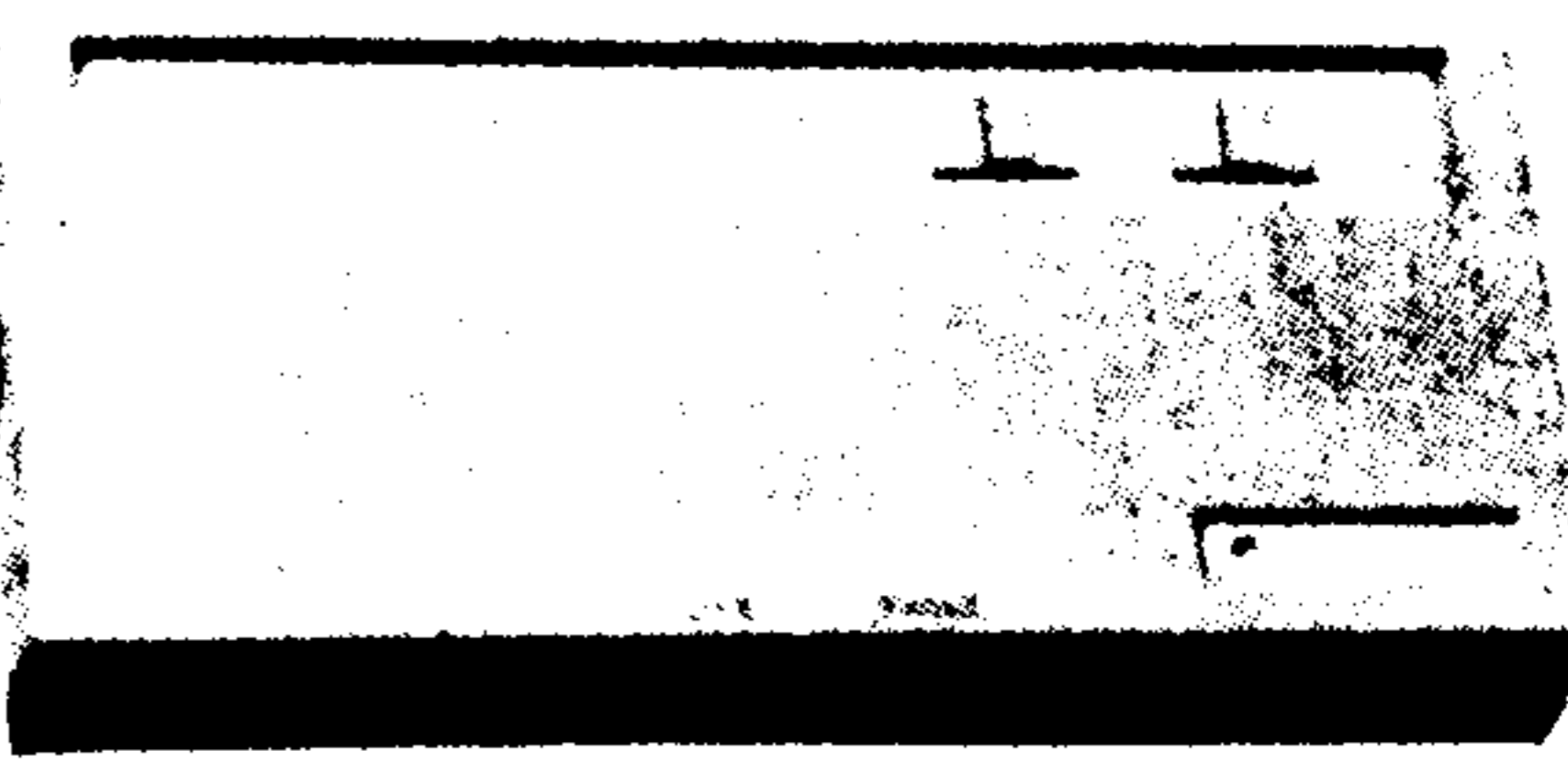

Send order and make checks payable to

TEX-COMP

PO BOX 33064 - GRANADA HILLS CA 91344



AUTHORIZED DEALER



VISA and MASTERCARD
HOLDERS CALL DIRECT
(818) 366-6631
24 Hour Order Line

TERMS: All prices FOB Los Angeles. For fastest service use cashiers check or money order. Add 3% shipping and handling (\$3.00 Minimum). East of Mississippi 4 1/2%. Add 3% for Credit Card orders. Prices and availability subject to change without notice. We reserve the right to limit quantities.

NOTE: Payment in full must accompany all orders. Credit card. Company check or Money order for immediate shipment. Personal Checks require up to 4 weeks to clear. California orders add 6 1/2% sales tax.

c99—

(Continued from Page 22)

```

    if((fi<13)&&(fi>9))
        printf("ideal level\n");
    else if((fi<15)&&(fi>7))
        printf("acceptable level\n");
    }
}
lgword(k,nwl,nl,c) /*function to count long words*/
int k,nwl,nl;
int c[];
{
    nwl=nwl+1; /*count long words*/
    /*reduce word count when suffixes increase letter count*/
    /*to more than 7*/
    if((c[k]== 'S')&&(nl<9))
        nwl=nwl-1;
    else if((c[k]== 'S')&&(c[k-1]== 'E')&&(nl<10))
        nwl=nwl-1;
    else if((c[k]== 'D')&&(c[k-1]== 'E')&&(nl<10))
        nwl=nwl-1;
    else if((c[k]== 'G')&&(c[k-1]== 'N')&&(c[k-2]== 'I')&&(nl<11))
        nwl=nwl-1;
    return(nwl);
}

```

Don't forget to load DSK1.PRINTF along with your object program and DSK1.CSUP.

So far we have input from the keyboard and output to the screen. Let us now write to the printer.

First it is necessary to open the printer file. The function **fopen()** opens a file for either input or output. The general form is:

```
unit = fopen(arg1,arg2);
```

where **unit** is a file descriptor (can have any variable name), **arg1** is the file name, and **arg2** is the type of access or mode. Each argument is enclosed within quotation marks. In standard C, the file descriptor is declared as a pointer. It is declared an integer variable in c99.

Since we are only dealing with the printer at this time, the open statement for an Epson RX80 printer is:

```
unit = fopen("PIO", "w");
```

The function:

```
fclose(unit);
```

will close **unit**.

Here are several printer write statements that can be used:

```
putc(character,unit);    is like putchar(character);
fputs(string,unit);     is like puts(string);
fprintf(unit,arg,arg,...); is like printf(arg,arg,...);
```

The output for the FOG INDEX program can also be directed to the printer by these additions:

```
extern fprintf(); /*is added before main()*/
#include DSK1.STDIO /*is added before main()*/
int pr; /*is added to the int declarations*/
/*add the following just before the final } in the program*/
pr=fopen("PIO","w");
for(i=1;i<=n;++i) /*the text to be tested is written*/
{ /*on the printer*/
    b=c[i];

```

```

    putc(b,pr);
}
putc(10,pr); /*double*/
putc(10,pr); /*space*/
fprintf(pr,"no. of characters %d\n",n);
fprintf(pr,"no. of words %d\n",nw);
fprintf(pr,"no. of sentences %d\n",ns);
fprintf(pr,"av. no. of words per sentence %d\n",av);
fprintf(pr,"no. of long words %d\n",nwl);
fprintf(pr,"no. long words per 100 words %d\n",wl);
fprintf(pr,"fog index %d\n",fi);
if(fi==17)
    fprintf(pr,"college graduate\n\n");
else if(fi<8)
    fprintf(pr,"too elementary\n\n");
else if(fi>17)
    fprintf(pr,"mostly unreadable\n\n");
else
{
    fprintf(pr,"%s\n",g[fi]);
    if((fi<13)&&(fi>9))
        fprintf(pr,"ideal level\n\n");
    else if((fi<15)&&(fi>7))
        fprintf(pr,"acceptable level\n\n");
}
fclose(pr);

```

The c99 compiler, functions, and utilities will just about take up one single-sided, single-density disk, so it will be necessary to use two disks. In order to change disks only once, include ASSM1, ASSM2, C99C, C99D, C99E, C99PFI, CONIO, CONV;C, EDIT1, STDIO, and STRING on the first disk, and C99PFF, CFIO, CSUP, FPRINTF, PRINTF, and SAVE on the second disk.

Note: STRING is the file name given to STRINGFNS file. CFIO is the file I/O library and contains the file tables and all the file I/O functions. STDIO contains definitions for console and file functions and extern specifiers for all functions in CFIO. STDIO is a c99 file and is used with #include and CFIO is an object file and loaded with your object program. When the CFIO library is used with a program, STDIO must also be included. CONIO contains the I/O definitions for console functions only. CONV;C contains string/integer conversion functions. CSUP is the compiler support library. PRINTF and FPRINTF are object files for the standard C formatted output functions (PRINTF for screen output and FPRINTF for file output).

The c99 program with printer output is written, compiled, assembled and saved on the first disk. To test the program, select E/A 3 (LOAD AND RUN) and load the assembled object program. Change to disk two and load the required function object files: DSK1.CSUP, DSK1.CFIO, DSK1.PRINTF, AND DSK1.FPRINTF. Press Enter. Type START and press Enter and you are hopefully on your way.

To review all the steps to save a program so that E/A 5 (RUN PROGRAM FILE) can be used, the Fog Index program with output on the screen and also the printer will be used.

(See Page 26)

1988 The Year Of The Upgrade Not The Up Trade

**A COMPLETE EXPANSION SYSTEM
9900 + FOR THE TI99/4A
THE ULTIMATE
99/4A EXPANSION SYSTEM
AT A SPECIAL
PRICE FROM TEX+COMP™**

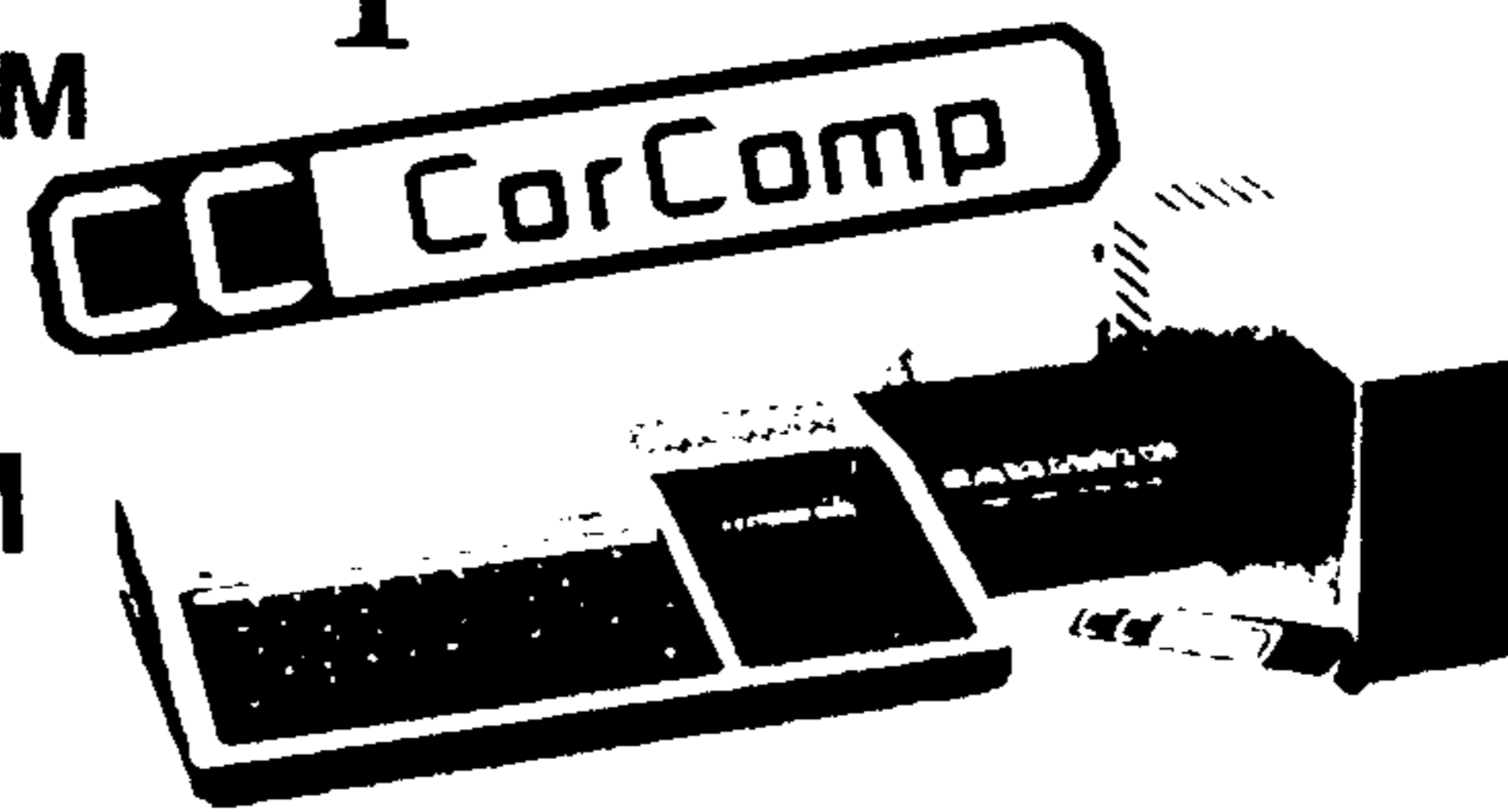

CorComp

**COMPLETE
EXPANSION SYSTEM
NOTHING ELSE TO BUY!**

TEX-COMP, the undisputed leader in supplying the 99/4A User, has now put together the finest and most complete expansion system ever offered for the TI99/4A.

- **9900 Expansion Box & Regulated Power Supply (UL Approved)**
- **32K Memory Upgrade** Adds 32K bytes of Random Access Memory to your system.
- **Double Sided/Double Density Disk Controller** (operates up to 4 drives)
- **RS232 Interface** Lets you add a wide range of other accessories, such as printers or telephone modems, one parallel and 2 serial outputs.
- **1 SS/SD Disk Drive** Allows you to store and retrieve data on 5 1/4-inch single- or double-sided floppy diskettes.
- **1 Disk Drive Case & Regulated Power Supply**
Handles two 1/2-height drives easily (UL or LAC Approved)
- **New Disk Manager with Improved Disk Utilities**
- **All Cables & Instructions** Including a free TI RS232 Y-Cable.

**ALL FOR
\$379.95**
Plus S&H

| | | |
|--|----------------------|-----------------|
| For above system with full size or 1/2-height DS/DD Drive | SPECIFY | \$399.95 |
| For above system with a pair of 1/2-height DS/DD Drives | NEW LOW PRICE | 499.95 |

| | |
|--|--------|
| CorComp RS232 Card (for TI P-Box) | 79.95 |
| CorComp 32K Card (for TI P-Box) | 99.95 |
| CorComp 256K P-Box Card | 169.95 |
| CorComp 512K P-Box Card | 229.95 |
| CorComp DS/DD Controller (for TI P-Box) | 149.95 |
| CorComp 9900 System with Free RS232 Y-Cable | 299.95 |
| CorComp Stand Alone RS232 with Free Y-Cable | 99.95 |
| CorComp Stand Alone 32K | 89.95 |
| Triple Tech P-Box Card (Clock/Buffer) | 119.95 |
| 9900 Clock Stand Alone | 69.95 |
| "Grom Buster" (for 1983 Consoles) | 24.95 |
| Load Interrupt Switch (with FREE Screen Dump Program) | 19.95 |
| PDI Diagnostic Module | 24.95 |
| NEW "Writer-Ease" Word Processor & Spell Check New Lower Price | 39.95 |
| IBM Connection (39.95 with Controller Card) | 49.95 |
| 1/2-Height DS/DD Disk Drive (2 will fit in P-Box) New Lower Price | 89.95 |
| Full Size SS/SD Disk Drive (exact replacement for TI 1250) | 59.95 |
| Full Size DS/DD Disk Drive | 79.95 |
| Drive Enclosure with Regulated Power Supply for 2 1/2-height or 1 full Drive | 39.95 |
| Cable Kit for 2 1/2-height Drives (for installation in P-Box) | 29.95 |

Send order and make checks payable to:

TEX+COMP

P.O. BOX 33064 - GRANADA HILLS, CA 91344



VISA and MASTERCARD
HOLDERS CALL DIRECT
(818) 366-6631
24 Hour Order Line

TERMS: All prices FOB Los Angeles. For fastest service use cashiers check or money order. Add 3% shipping and handling (\$3.00 Minimum). East of Mississippi 4 1/2%. Add 3% for Credit Card orders. Prices and availability subject to change without notice. We reserve the right to limit quantities.

NOTE: Payment in full must accompany all orders—credit card, company check or money order for immediate shipment. Personal checks require up to 4 weeks to clear. California orders add 6 1/2% sales tax.

A commented universal file reader

By ROBERT CARMANY

Several months ago, there was a "File/Read" program published in MICROpendium. While the program did a good job of reading the files that were included in the menu, it was awkward to use with files that didn't fit into the template. With that in mind, I set out to modify and improve the program so that it will read any file not in program format.

Rather than try to explain what was done as far as the actual planning of the program itself, I have decided to present the program as "commented XB code."

```

110 ! ***** !025
120 ! * UNIVERSAL * !018
130 ! * FILE READER * !012
140 ! * BY * !242
150 ! * BOB CARMANY * !053
160 ! * VERSION 4.0 * !015
170 ! * XB * !241
180 ! ***** !025
190 ON BREAK NEXT !191
200 CALL CLEAR :: CALL SCREEN
N(5) :: DISPLAY AT(2,8): "FILE
READER": " VERSION 4.0
": " "&RPT$( "-",24):: DISPLAY
AT(14,1): " "&RPT$( "-",24)!0
44
210 DISPLAY AT(10,4)BEEP: " IN
STRUCTIONS (Y/N)? N" :: ACCE

```

c99—

(Continued from Page 24)

1. Disk one will be used to write, compile and assemble the program.
2. Select 3 (LOAD and RUN), load DSK1.C99PFI and your program object file (assembled program).
3. Remove disk one and insert disk two.
4. Load DSK1.CSUP, DSK1.CFIO, DSK1.PRINTF, DSK1.FPRINTF, DSK1.C99PFF, and DSK1.SAVE files in this order.
5. Press Enter.
6. Type SAVE and press Enter.
7. Type DSK1.name-of-program and it will be saved on disk two.

You can now test it out by selecting 5 and hopefully it will run. Save the program to a program disk so that these two disks can be used again. You may want to save the program as it is written in c99 also.

Good luck!

REFERENCES

"The Technique of Clear Writing" by Robert Gunning, McGraw-Hill, 1952; "FOGINDEX" by Phillip P. Gross and Karen Sadowski, Journal of Reading, April 1985.

```

PT AT(10,24)VALIDATE("YyNn")
SIZE(-1):CHOICE$ :: DISPLAY
AT(10,4):RPT$( "-",24):: IF C
HOICE$="N" OR CHOICE$="n" TH
EN 220 ELSE GOSUB 560 !151

```

This first section of code is straightforward and fairly simple to understand. The first section is the program header (attribution, etc.) which is followed by line 190 which disables the FCTN 4 (break) key. The rest of the section presents the program title, some simple graphics and a prompt to give the user a choice of whether or not they wish to read the instructions. If so, the program branches to line 550. Otherwise, it continues to the next section.

```

220 DISPLAY AT(8,1)BEEP: "Dev
ice. Filename": ">" :: ACCEPT
AT(9,2)SIZE(15):FILE$ :: IF
FILE$="" THEN 220 :: CALL ER
ASE !180
230 DISPLAY AT(16,1): "Device
.Filename" :: DISPLAY AT(17,
1): ">"&FILE$ !030
240 DISPLAY AT(8,1)BEEP: "Fi
le Descriptors (Choose 1)" ::
DISPLAY AT(9,1): "1) DISPLAY
,VARIABLE": "2) DISPLAY ,FIX
ED" !067
250 DISPLAY AT(11,1): "3) INT
ERNAL ,VARIABLE": "4) INTERNA
L ,FIXED" :: DISPLAY AT(13,2
0): "1" :: ACCEPT AT(13,20)VA
LIDATE("1234")SIZE(-1):A ::
CALL ERASE !042
260 DISPLAY AT(8,1)BEEP: "Rec
ord Length" :: DISPLAY AT(9,
6): "80" :: ACCEPT AT(9,6)VAL
IDATE(DIGIT)SIZE(-3):L :: CA
LL ERASE !030
270 ON A GOTO 280,290,300,31
0 !053
280 ON ERROR 620 :: DISPLAY
AT(20,1): "DISPLAY ,VARIABLE"
:: DISPLAY AT(20,19):L :: O
PEN #1:FILE$,INPUT ,DISPLAY
,VARIABLE L :: GOTO 320 !074
290 ON ERROR 620 :: DISPLAY
AT(20,1): "DISPLAY ,FIXED" ::
DISPLAY AT(20,16):L :: OPEN
#1:FILE$,INPUT ,DISPLAY ,FI
XED L :: GOTO 320 !117
300 ON ERROR 620 :: DISPLAY
AT(20,1): "INTERNAL ,VARIABLE
" :: DISPLAY AT(20,20):L ::
OPEN #1:FILE$,INPUT ,INTERNA

```

```

L,VARIABLE L :: GOTO 320 !22
1
310 ON ERROR 620 :: DISPLAY
AT(20,1): "INTERNAL ,FIXED" :
: DISPLAY AT(20,17):L :: OPE
N #1:FILE$,INPUT ,INTERNAL,F
IXED L :: GOTO 320 !017
320 DISPLAY AT(8,1): "Paramet
er Flag ": "1 For DISPLAY Fil
es": "2 For INTERNAL Files" :
: DISPLAY AT(10,22): "1" :: A
(XCEPT AT(10,22)VALIDATE("12"
)SIZE(-1):Z :: CALL ERASE !0
92
330 F=Z !094

```

This next section of code is a little more complex and some background information is in order. When I was pondering the problem of trying to determine exactly how to access the various files, I determined that there were three factors to consider. The first was whether the file was DISPLAY or INTERNAL, whether it was VARIABLE or FIXED, and the file length (ie. 128, 80, etc.) If you disregard the record length which can be entered as a prompt, all of the file types can be broken down into four choices — DISPLAY/VARIABLE, DISPLAY/FIXED, INTERNAL/VARIABLE and INTERNAL/FIXED. Those choices are selectable with a single keystroke.

The first prompt asks for the Device.Filename (ie. DSK1.filename). The file descriptors follow. These are followed by the record length. In each case, an ON ERROR statement is included so that the program won't crash if an error is made in the file selection. The CALL ERASE branches to a subroutine to clear the screen after each entry. To aid in file selection, your choice is printed at the bottom of the screen after it has been made and the described file is opened in an INPUT mode (ie. it can be read from only).

The last prompt is for a parameter flag to make keeping track of the file type easier and determines whether INPUT or INPUT is used to read the files from disk.

```

340 DISPLAY AT(8,1)BEEP: "Pri
ntout of file? (Y/N) N" :: A
CCEPT AT(8,25)VALIDATE("YyNn
")SIZE(-1):P$ !167
350 IF P$="N" OR P$="n" THEN
(See Page 27)

```

FILE/READ—

(Continued from Page 26)

```

450 !042
360 DISPLAY AT(8,1)BEEP: "Printer
device name " :: DISPLAY
AT(10,1): ">PIO" :: ACCEPT
AT(10,2)SIZE(-3):PRINT$ !
186
370 DISPLAY AT(23,1): "Printer
> "&PRINT$ :: CALL ERASE !
136
380 ON ERROR 620 :: OPEN #2:
PRINT$,OUTPUT,DISPLAY !245
390 IF EOF(1)THEN 510 !045
400 ON F GOTO 410,420 !236
410 LINPUT #1:A$ :: GOTO 430
!059
420 INPUT #1:A$ !163
430 CALL KEY(0,K,S):: IF K=1
3 THEN 540 :: IF S<>0 THEN 4
30 ELSE PRINT A$ :: PRINT #2
:A$ !058
440 GOTO 390 !214
450 IF EOF(1)THEN 520 !056
460 ON F GOTO 470,480 !100
470 LINPUT #1:A$ :: GOTO 490
!119
480 INPUT #1:A$ !163
490 CALL KEY(0,K,S):: IF K=1
3 THEN 540 :: IF S<>0 THEN 4
90 ELSE PRINT A$ !070
500 GOTO 450 !018
510 CLOSE #2 !152
520 CLOSE #1 !151

```

This section of the program is the section that actually does the file reading and, optionally, dumping the file to a printer. The beginning of the section asks for a printer device name (PIO is the default). The length of the printer name can be changed by increasing the SIZE(-3) to the number of characters that you need (line 360).

Again, we use the CALL ERASE and ON ERROR routines to clear the screen and control errors in file access.

The files have been designated as #1 for the disk input file and #2 for the printer output. In each case, a safety hatch has been provided to allow aborting the file reading process by pressing Enter while the file is being read. The parameter flag determines if LINPUT (for INTERNAL files) or INPUT (for DISPLAY files) is used to read and print the file. Because the INTERNAL files contain unprintable

characters, LINPUT is used to read and print those files. Lines 410 and 420 print the file and 470 display the files on the screen.

Finally, when the End of File marker is reached, the appropriate files are closed to prevent data loss.

```

525 FOR DE=1 TO 2000 :: NEXT
DE !173
530 DISPLAY AT(12,[])ERASE ALL:
"Read Another File? (Y/N)
N" :: ACCEPT AT(12,26)SIZE(-
1)VALIDATE("YnN"):Z$ IF Z$=
"Y" OR Z$="y" THEN 200 ELSE
!038
540 END !139

```

This section of the program contains the end routine. It provides a delay and asks if you wish to read another file once the previous one is finished. Pressing "N" or "n" terminates the program and "Y" or "y" restarts is from line 200 to allow you to re-enter your program prompts.

```

550 DISPLAY AT(2,1)ERASE ALL:
"To use this program, simply
y": "follow the input prompts
": "as they appear on the scr
een" !013
560 DISPLAY AT(9,1): "The 'Re
cord Length' prompt": "is the
record length that": "appear
s at the end of the": "file d
escription": "(ie. D/V 80)" !
077
570 DISPLAY AT(16,1): "You ma
y stop the screen": "scrollin
g by pressing ANY": "key or <
ENTER> to abort the": "file p
resentation": !158
580 FOR DE=1 TO 3000 :: NEXT
DE !174
590 CALL CLEAR :: DISPLAY AT
(1,8): "FILE READER": "
VERSION 4.0": " "&RPT$("-",24
):: DISPLAY AT(14,1): " "&RPT
$("-",24):: RETURN !029

```

Lines 550-580 are the on-screen instructions that can be selected right after the program starts. Line 590 re-writes the initial screen and then uses RETURN to restart the file entry -> printing -> reading cycle.

```

610 CALL CLEAR :: CALL SCREE
N(7):: DISPLAY AT(12,1): "YOU
HAVE JUST ENCOUNTERED A": "F

```

```

ATAL I/O FILE ERROR. ": "PLEAS
E RE-ENTER YOUR FILE" !153
620 DISPLAY AT(15,1): "PARAME
TERS" :: FOR DE=1 TO 1000 ::
NEXT DE :: RUN !175

```

This is the error handling routine that appears at the beginning of each of the file descriptor lines and whenever a file is opened. It turns the screen red and prints the "Fatal I/O Error" message on the screen and then inserts a short delay. Line 620 uses RUN to re-RUN the program and clear the error condition. Normally, this would cause a delay while the program initialized but we have overcome that slight problem by using J. Peter Hoddie's PRESCAN-IT! to virtually eliminate the prescan time.

```

630 SUB ERASE :: DISPLAY AT(
8,1):RPT$(" ",162)!015
640 SUBEND !168

```

These two lines are the CALL ERASE routine that clears the screen after each of the prompts. It simply uses DISPLAY AT to blank out the screen with spaces in the appropriate places.

When an Extended BASIC program starts, there is sometimes a long pause after the program loads and before it starts execution. During this time, the computer is allotting space for arrays, initializing variables, and other housekeeping tasks. This time can be cut to nearly nothing by using PRESCAN-IT!. In addition, we can substitute constants for the variables which saves memory space and also speeds program execution. I had planned for this when RUN was used to clear out the error condition with the error handling routine.

The following lines are added to the program when it goes through PRESCAN-IT!.

```

1 @=0 :: [=1 :: ]=2 :: _=3 :
: \=4 :: GOTO 110 :: A$,CHOI
CES$,FILES$,P$,PRINT$,Z$ :: A,
DE,F,K,I,S,Z :: CALL CLEAR :
: CALL KEY :: CALL SCREEN !1
42

```

Finally, the program is RESequenced starting with line 100.

As I said in the beginning, this File/Read program will read any file except those in program format. You will be disappointed (See Page 28)

Text-to-Speech with GK and A/L

By JOHN TRUNDLE

I have found one more of the many uses for the GRAM Kracker from MG: access to the Text-to-Speech utility contained in the Terminal Emulator cartridge from assembly language programs. Now it should be relatively easy to include an unlimited vocabulary of spoken English in assembly language programs, as opposed to trying to wade through the near Greek process outlined in the Editor/Assembler manual.

I have always been disappointed at the limited vocabulary available from Extended BASIC and frightened off by the long, meaningless data strings and "timing considerations" required for speech in assembly language. I also wanted a way to access the speech capabilities of the console BASIC/TEII combination from a more powerful language. Unfortunately, the Text-to-Speech utility still remains closed to Extended BASIC because it is not possible to load both cartridges into the GRAM Kracker simultaneously. But now, at last, there is a way around the problem in assembly language.

The steps to accomplish this are relatively simple:

1. Use the E/A Mover utility included with the GRAM Kracker to move the contents of the Editor/Assembler cartridge into either GRAM 1 or 2.

2. Use the loader to move the TEII cartridge into the GRAM Kracker, then reset

the system.

3. Select the Editor/Assembler option from the main menu (it will be necessary to turn the loader off if you moved E/A into GRAM 1).

4. Choose option 3 — Load and Run — to load your program. Enter the name of your object code file. When prompted for a second file, just press Enter. Because the program requires the use of a GPL routine, it is not possible to use the autostart feature of assembly language.

5. Enter your program name, START in the case of the demo program included here.

The only real trick in the assembly language program is to use the GPLLNK to access the device, or file, "SPEECH", and to treat it exactly as you would CS1, with the exception of the device name and the length of the name. This is all covered in Chapter 16 of the Editor/Assembler manual on how to access the cassette port through GPLLNK, and in Chapter 18 on how to set up the required PAB. Or examine the enclosed source code of the sample program.

The demo program is only that, of course, but it should give you a good indication of its potential. It could easily be expanded to include a keyboard input routine, or to include a memory check to verify that the system is set up properly, i.e. in the GRAM Kracker. If so, the technique then could be included in soft-

ware intended for general release.

In the course of writing this letter it occurred to me that if this works for assembly language, it also should be applicable to Forth normally running out of the Editor/Assembler cartridge. Sure enough, it does, and I have included a Forth screen which also accesses the Text-to-Speech. The only real difference between it and the assembly language version is that the Forth lets you enter a short phrase from the keyboard.

Lines 1 to 8 establish the PAB block in VDP memory. The Forth word TALKER does much the same thing as the assembly language routine "DSR", clearing the GPL Status byte, moving the name "SPEECH" to FAC, setting >8354 and >8355 to 6 (the length of SPEECH), clearing >83D0, and setting >836D to 8, then uses GPLLNK to call the GPL DSR routine.

The first invocation of TALKER in line 12 OPENS SPEECH.

The last word, SAY, accepts a string up to 26 letters from the keyboard, (INPUT A\$), then uses TALKER to write it to "SPEECH", (Print #1:A\$). The length of the input phrase can be altered by changing the three 1As in lines 13 and 14 to whatever you require, up to 255, or FF hex.

To use SAY, just type: SAY <ENTER> THE PHRASE TO BE SPOKEN IS

The stress, inflection and pitch indicators (<.>., ^, and //pp fff) all work as well.

Turn to page 29 for a listing of the assembly language speech program. This program is of use only to those with a GRAM Kracker.—Ed.

FILE/READ—

(Continued from Page 27)

if you try to read files with a record length of greater than 128. Those types of files, as well as those written in INTERNAL format, are largely tokenized and do not lend themselves to being displayed or printed. This program will handle Forth and other files with a record length of 128 and all of those unusual files with a shorter record length.

Myarc Geneve 9640 IN STOCK!!

ENHANCED KEYBOARD SALE PRICE \$520.95

★★★★ ——— OTHER MYARC PRODUCTS ——— ★★★★★

FLOPPY DISK CONTROLLER-----\$164.95

GENEVE MY-ART AND MOUSE-----\$125.95

512 MEMORY CARD FOR GENEVE \$255.95

MYARC RS232-----\$120.95

(TAKING ORDERS AVAIL IN APRIL)

HARD DRIVE DISK CONTROLLER \$319.95

SEND ORDERS TO #305-625-7944

Mosher Computer Services

17175 NW 41 AVE MIAMI, FL. 33055

CARL MOSHER PRESIDENT

S H \$5.00 EACH ITEM. FLA. RESIDENTS

ADD 6% SALES TAX. PERSONAL CHECKS

REQUIRE UP TO FOUR WEEKS TO CLEAR.

HARDWARE MANUAL FOR THE TI 99 / 4A

IT DESCRIBES:

- CONSOLE DESIGN
- CUSTOM CHIP OPERATION
- TMS 9900 H/W ORGANIZATION
- TMS 9900 INSTRUCTION SET
- INTERFACING PITFALLS
- CONSOLE SCHEMATICS
- PEB CARD DESCRIPTION
- GROM SIMULATOR DESIGN
- EXTENDED BASIC MODULE DESCRIPTION & SCHEMATICS

WEEKEND HARDWARE SEMINAR
(INFORMATION AVAILABLE ON REQUEST)

Send \$19.95 Check or Money Order To:
(CANADA & FOREIGN SEND \$23.00 U.S. FUNDS)
(VOLUME RATES AVAILABLE - ON REQUEST)

THE BUNYARD GROUP
PO BOX 53171, LUBBOCK, TX 79453



Dallas fair is April 30

The Dallas-area TI fair is scheduled to be held at the Holiday Inn at 1655 North Central Expressway in Richardson, Texas, April 30.

The fair is sponsored by the Forest Lane Users Group, the NET 99ers, the Paris TI Users Group and the Brazos Valley Users Group, according to Richard Fleetwood of FLUG.

A get-together for early arrivals will be held the evening of April 29, Fleetwood said.

TI is scheduled to send a representative on behalf of the TI74 Computer Calculator and of its Consumer Relations/Service Department, he said.

For further information, call Fleetwood at (214) 328-9257 or Roy Willis at (214) 231-2168.

User Supported Software

User Supported Software is non-commercial software. It is written by users for the benefit of other users. User Supported Software is frequently updated by authors and users. Costs are determined by the author. MICROpendium provides listings of User Supported Software as a service to readers and authors. A listing in MICROpendium does not imply suitability or utility of any program. MICROpendium would like to be notified of any problems encountered by authors and readers, though the magazine cannot act as an intermediary.

Allow 4-6 weeks for delivery of software. Unless stated, included formatted disks, self-addressed return mailer with postage. (The notation D,PRM with listings stands for disk, postage and return mailer.).

To submit items for inclusion in User Supported Software, send a copy of the item and an announcement describing it as well as system requirements to MICROpendium. State also that you are author or sole copyright holder and that you have your permission for the item to appear in User Supported Software listings. Items will remain in the listing until removed by the author. Anyone who has submitted an item for this column that has yet to appear should contact MICROpendium.

A complete listing of User Supported Software is updated quarterly and is available from MICROpendium for \$2. The listing runs about 12 pages.

THREE DICTIONARIES FOR SPELL-CHECK

Orval D. Givens, HHB 108th ADA BDE, APO INY 09227-2531, has released three dictionaries for use with 99/4 Auto Spell-Check. The three contain more than 23,000 words. The dictionaries are available on three SSSD disks. Send three SSSD disks and postage paid return mailer or \$7.50 if you would like him to provide the media and postage. If you include copies of your user dictionaries, he will merge them into these dictionary files. He asks for a donation of \$3-\$10 from those who find the files useful.

BALLRANK FOR GRID FOLLOWERS

Allan Cox, 728 Jefferson Blvd., Tarrant, AL 35217, says BALLRANK can be used to aid football fans in determining expected scores and point spreads. The program requires X BASIC, Multiplan, Side*Print, and a printer. The primary source of data is Game Plan College Football Annual Preview. The package consists of three programs: Pointspread, Rating and Ranking. During 1987, Cox says, he ran data on 451 games and picked 323 winners, a success rate of 71.6 percent. He picked 8 of 14 bowl games correctly for a 57.1 percent success rate. D;PRM.

RECORDS/PLUS

Steve Risner, 1351 Sierra Alta Dr., Tustin, CA 92680, is offering Records/Plus, a disk-based database program that runs

(See Page 40)

Text-to-Speech A/L demo

```

DEF START
DEF VMRW, GPI.LNK, VSBW, VSBR
STATUS EQU >837C
FAC EQU >834A          FAC address for the GPL routine
PTRNTR EQU >8356      pointer to the byte after SPEECH
BUFADR EQU >1000      VDP buffer for file transfer
PARADR EQU >F80       VDP address for the PAB
PAB DATA >0012, BUFADR, >5000, >0000, >0006
DEV TEXT 'SPEECH'     file description
MESS TEXT 'USING THE ^GRAM KRACKER TO'
MESS2 TEXT 'MAKE ^ASSEMBLY LANGUAGE '
MESS3 TEXT 'SPEAK JUST LIKE BASIC DOES'
WRITE BYTE >03        print op code
CLOSE BYTE >01        close op code
COUNT BYTE >1A      length of message to be spoken
EVEN
RETURN BSS 2
WS BSS >20
START MOV R11, @RETURN
LWPI WS
LI R0, PARADR          establish PAB
LI R1, PAB
LI R2, 16
RUF @VMRW
R @DSR                 'OPEN #1:"SPEECH"'
MOVB @WRITE, R1        prepare for a file write
LI R0, PARADR
RUF @VSRW
MOVB @COUNT, R1      length of message => PAR
LI R0, PARADR+15
RUF @VSRW
LI R0, BUFADR          move message to VDP buffer
LI R1, MESS
MOVB @COUNT, R2
RUF @VMRW
R @DSR                 'PRINT #1:MESSAGE$'
LI R0, BUFADR
LI R1, MESS2
MOVB @COUNT, R2
RUF @VMRW
R @DSR                 'PRINT #1:MESSAGE$'
LI R0, BUFADR
LI R1, MESS3
MOVB @COUNT, R2
RUF @VMRW
R @DSR
MOVB @CLOSE, R1       prepare to close file
LI R0, PARADR
RUF @VSRW
R @DSR                 'CLOSE #1'
MOV @RETURN, R11
R #R11                return to ED/ASS
*
* Device Service Routine for SPEECH
*
DSR CLR @STATUS        clear the GPL Status byte
CLR @>83D0            set the word @ >83D0 to >0000
LI R3, 6
MOV R3, @>8354        set >8354 to length of 'SPEECH'
MOV @DEV, @FAC        move device name to FAC
MOV @DEV+2, @FAC+2
MOV @DEV+4, @FAC+4
LI R3, >0800
MOVB R3, @>836D        indicate a DSR call
LI R3, PARADR+16
MOV R3, @>8356        set >8356 to next byte after 'SPEECH' in PAB
RUF @GPI.LNK          utilize GPL link
DATA >003D           to DSR
*
RT                    return
END

```

Turn to page 46 for a Forth demo of the Text-to-Speech program.

Penn Ohio group operates BBS

The Penn Ohio Users Group operates a BBS in the Youngstown, Ohio, area, according to Gary Karas, club secretary. The TI-NET board contains an E-Mail message base, Gameroom and Casino. The protocol for the 24-hour board is 300 or 1200 baud, seven bits, one stop bit and no parity. Sysop is Ed Luptak. Phone number for the board is (216) 755-8220.

Geneve

So you've had some problems

By MIKE DODD

This month's column will center around the problems users have had with the Geneve 9640 system.

One of the biggest causes of problems has been not having up-to-date software. While it is next to impossible to keep up with all of the latest software, anything released in the past several months has a better chance of working than earlier software. This is not an absolute, however: Some recent versions of software, most notably MDOS, have had major bugs in them. When found, these bugs were fixed, but not everyone who got the original, buggy copy got the fixed version.

An important note: To use much of the new software, you must be using the .97 EPROM. The only other version is the .95 EPROM. .95 loaded a 33-sector file named BOOT, and came up to a DSK1 > prompt. .97, on the other hand, displays a picture of a swan while loading, and loads a file named SYSTEM/SYS, which comes up to an A > prompt. If, by some chance, you are still running the .95 EPROM, you should contact Myarc to arrange for a replacement.

The latest official versions of Geneve software, as of Feb. 4, 1988, are:

MDOS V1.01

GPL V0.99

MY-Word V1.1

Myarc Disk Manager III V2.1

Multiplan V1.0

Advanced BASIC and Pascal are not yet completed. A note about Multiplan: All versions of it have been labeled V1.0. The latest (and probably final) version of Multiplan had this major change: the OVERLAY file is loaded on powerup, and is not accessed again. You can test loading of the OVERLAY file by loading Multiplan, choosing Transfer, Load, and press the down arrow for a catalog. Previous versions would then access the OVERLAY file to load the disk directory portion of the program from disk. The latest version will not.

There are two major kinds of MDOS: the first was not really a DOS — rather, it came up immediately to the GPL cartridge loader screen. The second kind was actually a DOS, and came up to an A >

prompt. The latter version can access the GPL cartridge loader by loading a separate program, known as GPL.

In late January-early February, Myarc made (past tense) a mailing of the above listed software to all registered Geneve owners. If, by chance, you are a registered owner and did not receive the mailing, contact Myarc — it probably got lost in the mail.

Myarc is also supplying a saved copy of the Editor/Assembler cartridge on the GPL disk. This is not any different from the standard TI E/A cartridge, as some people have thought.

One known problem with the Geneve's disk access routines is that, very rarely, the Geneve will create two copies of a file when saving. That is, if you catalog the disk, the filename will show up twice. Some people have corrected this occurrence by deleting one of the filenames with a disk manager program — you should not do this. When the problem occurs, the extra list of the filename is usually just another pointer to the exact same file, residing in the exact same sectors. When you delete one, the disk manager changes the sector bitmap to report that those sectors are no longer in use, despite the fact that the other file header is really still using them. The next time you write to that disk, the DSR will use those "free" sectors to save the file — overwriting the first file.

There are two safe ways of deleting the extra file. One is to use a sector editor to remove one of the file pointers. However, you must be knowledgeable with sector formats to do this successfully. An easier way is to use a disk manager to copy all the files on the disk, with the single exception of one of the extra filenames, to another blank disk. Then re-initialize the first disk and copy the files back onto it. This bug is an inconvenience, but it has not yet caused any loss of data.

Another reported problem has been with the DISKCOMP command: After comparing a disk, if you answer Y to the question "Compare another (Y/N)?", the compare disk will not work. Until the bug is fixed, you should always answer N, and then re-enter the command if you need to

compare another (a quicker way to re-enter the command is to press up-arrow, which recalls the last typed command, then Enter).

A major problem people have been having with the Geneve is with printing in GPL mode: If you have a SPOOL command in the AUTOEXEC file, attempting to print a document will cause lockup (this problem was discussed in more detail in last month's Geneve column).

There are some versions of GPL labeled V0.98 that do not correctly access the RAMdisk function. When cataloging the RAMdisk, the number of free and used sectors will total somewhere around 8400 sectors. If you have one of these versions, use a sector editor and edit the first (and only) sector of the GPL file: at byte 148 (hex >94), change (in hex) 20D0 to 02D0. This should fix the problem with the RAMdisk. V0.97 and V0.99 do not have this problem.

The version of BASIC being shipped with the Geneve is currently no more than a conversion from V2.11 of Myarc Extended BASIC II (originally written for the 99/4A with RAMdisk) ported over to the Geneve. It is not Advanced BASIC, and as such, few of the commands and example programs in the Myarc Advanced BASIC manual will work. Advanced BASIC is being worked on by Myarc, but it is not yet complete. Unfortunately, when Myarc XB was converted over from the 99/4A to the 9640, many bugs were introduced, especially in the math functions — at times, the math functions will work, at other times, it will crash with an error. Until Advanced BASIC is released, it is best to use a saved copy of TI, Mechatronics or Triton Extended BASIC. Even when Advanced BASIC is released, there will be many XB programs that will not run under Advanced BASIC, including almost all programs that use any assembly language CALL LINKs.

It is true that Myarc originally said that the Geneve would have speech built in, but as the design of the Geneve progressed, this was dropped. If you wish to have speech capability, you must purchase the Rave 99 Speech interface card (available

(See Page 31)

GENEVE—

(Continued from Page 30 for approximately \$50), which allows you to plug your speech synthesizer into the PEB.

Myarc has shipped (to dealers only) copies of a fix to the Video Chess cartridge. The fix contains the patch to make the cartridge work, as documented in the November 1987 MICROpendium, as well as an additional change to allow saving and loading of games to/from disk, as opposed to being locked into cassette, an option not available with the Geneve (the modification was first published by me in the L.A. TopIcs Users' Group newsletter). When you attempt to save or load a game, it will prompt you for a filename — type it in and press Enter (FCTN 3 is the only function key that will work). The fix is supplied as two files: CHESS and CHESS4. To use it, prepare a disk and save your standard TI Video Chess cartridge to it. Then copy the CHESS and CHESS4 files over the saved files. The disk now contains a copy of Video Chess that will work on the Geneve and allow saving and loading of files.

One user complained that he could not get the TI Disk Manager program to initialize a disk, nor could he manage to load the CorComp Disk Manager. I was able to use the TI DM to initialize a disk with no problems — the problem may have been that the user was using an older version of MDOS or GPL. There is no way to load the CorComp DM on the 9640. Even if it could be loaded, the way the program is

written makes it totally incompatible with the Geneve. You can use DM1000, TI DM, Myarc Disk Manager III V2.x, or MDOS to use disk management utilities.

MULTIPLAN MOD

Ron Walters, of Cleveland, Ohio, asks how to make Multiplan look at a specific drive instead of searching through all drives before getting to the correct drive. This is useful for loading the MP files on a Horizon RAMdisk for near-instant retrieval. Most of the changes are in the last saved cartridge file (i.e. if you saved the cartridge as MP, the changes would be in file MP4). Be sure to modify a backup copy, in case something goes wrong.

In the first sector, you will see the filenames, e.g. DSK.TIMP.MPINTR. Change all the filenames to DSKx.filename (e.g. DSK6.MPINTR), eliminating the TIMP. Write the sector to disk and go forward two sectors, so that you are editing the third sector of the file. At byte 88 (hex >58), change the hex byte >0F to >0B and write the sector back to disk.

The rest of the changes are in the MPDATA file. At sector 30 of that file (the next to last sector) change byte 248 (hex >F8) from >0003 to >0004 and write the sector to disk. In the next (and last) sector, change the first word (two bytes) from >380D to >380E. Then change byte 28 (hex >1C) from >0003 to >0004. The filename length byte for DSK.TIMP.OVERLAY is at byte 227 (hex >E3). Change the length of >10 to >0C and the filename to

DSKn.OVERLAY, where n is the drive number. Write the sector to disk and test your changes. That's it!

Ken Woodcock of Norfolk, VA, asks the same question, but about MY-Word. For MY-Word, look for the filenames of the various files in the MW file. Change the names and the length byte in front of them — i.e. if you changed DSK.MYWORD.CONTROL to DSK6.CONTROL, you would need to change the hex byte >12 in front of "DSK" to a >0C. Repeat for all files and write to disk. In sector 5 of MW (the sixth sector), at byte 172 (hex >AC), change the two hex words D801 3898 to 0460 39BA. You should also change the filename and length byte of DSK.MYWORD.HELP, which is located in the MYCAT file.

A commonly asked question is how you are going to be able to run Pascal programs written for the IBM or Apple computer on the Geneve's Pacal interpreter — is it as simple as putting the disk with the IBM or Apple program in the drive? According to Jack Riley, marketing director for Myarc, you cannot read IBM or Apple disks on the Geneve. To run IBM or Apple programs, you need to convert them to the Geneve disk format. You can do this by sending the file from the IBM/Apple to the Geneve over a modem, or by downloading the program from a BBS or Network. You will then run the program through a converter program called 'REMTALK,' which will convert the file to a file runnable by Pascal.

Making the most of MDOS

Creating an autodialer

By WALT HOWE

Here is an interesting way to create an autodialer from MDOS. You can use it for either voice or data calls.

— First, create a set of one line files on disk, each with their own filename. Each file should consist of ATDT (or ATDP) and the appropriate phone number, such as: ATDT1-617-331-4181.

This is the number of the Boston Computer Society TI BBS #1, so give it a filename of BCS, for example. The easiest way to do this from MDOS is to type it

right to disk. Put a fresh disk in the A > drive (or whatever is your default drive), and type:

COPY CON BCS — (this opens a file named BCS within MDOS, which will write to disk when you type a control-Z.)

ATDT1-617-331-4181 (omit dashes, if you prefer; use ATDP instead if you use pulse dialing).

Z — (control-Z, which writes the BCS file to your default drive).

Repeat this for each number you want included, each with its own filename.

— Next, type COPY CON CALL to create the following file, named CALL: TYPE %1 > RS232

Save this file with a control Z, also.

Once these files are set up in your default drive, all you need to do to autodial is to turn on your modem and type, for example, CALL BCS. If it is a voice call, pick up your phone and you will be ready to talk (not to the BCS, however, it's not voice). If it is a data call, go ahead and load your terminal emulator. If it is Jim Schroeder's (See Page 32)

GETTING THE MOST FROM MDOS—

(Continued from Page 13)

NOTMYTERM you are using, just add NOTMYTERM as a second line to the CALL file, and it will load after dialing. Put a PAUSE line or two in between, if you want to wait for a CONNECT first before loading.

Why does this work? When you type and enter CALL BCS, MDOS looks for a file on the default drive with the filename CALL. It stores the word BCS as a parameter of the file name CALL. When MDOS reads the first line of the CALL file and finds the %1 variable, it substitutes the parameter BCS for the %1. It then proceeds to TYPE the file named BCS, but instead of displaying it onscreen as the TYPE command normally does, the >RS232 channels it to the RS232 card, which in turn passes it to your modem.

MDOS NEWS

MDOS 1.01 has several bugs in it. The GOTO command does not find labels correctly, which limits the flexibility of programming in MDOS. Secondly, as many found out on March 1, it does not figure out the day of the week correctly after leap year day. Both of these bugs have been corrected and will appear in the next version. An enhanced version of MDOS has been written and will be released only after thorough testing.

Myarc has promised that files you load into a RAMdisk from MDOS will be passable into GPL mode. Myarc also indicated that the reverse will be true, so that you can bring files back out of GPL mode to MDOS mode. This is a welcome addition. If you routinely want certain files available from RAMdisk, you will be able to load them with an AUTOEXEC file at powerup and carry them automatically into GPL mode. Once this is implemented, we will publish some more sample AUTOEXEC files to show you more of the tricks of the trade.

JUMPBOOT

Jerry Coffey and Disk Only Software previously released a super fast, specially manufactured 5¼-inch floppy disk for booting MDOS. By changing the interlace and skew and initializing the disk in some ways not directly available to the 99/4A or 9640, the disk would load nearly as fast as a hard drive.

I have been fortunate to beta test a new

3.5-inch version of the JUMPBOOT disk, and it works even faster from the little 80-track devices. I timed the boot as taking 5.2 seconds from the time the drive light went on until MDOS was up and running. I was previously booting from a Horizon RAMdisk, but after seeing the speed the JUMPBOOT gave, I permanently moved SYSTEM/SYS out of my RAMdisk. It was a delight to free up 358 sectors on the RAMdisk for other files. The specially formatted JUMPBOOT disk still has 3200 more sectors for other files on it, too. They won't load as fast as SYSTEM/SYS does, but the load rate is still fast. This disk is for Myarc controllers only — either the old one or the new Hard and Floppy Disk Controller Card. If you have been considering adding 3.5-inch drives, this is one more good reason to do so.

So tell me, Jerry, are you going to do a 1.44 megabyte, 36-sector, 80-track version for the new HFDDC?

PROGRAMMING SUPPORT

Myarc is planning to release a Program Development System later this year, but for those who want to start developing programs now, there are a number of tools available.

Paul Charlton has released a LINKER

for assembly programs and a draft manual detailing the XOP support available for memory management, input/output routines, video display, math functions, keyboard support, and various utility routines. Charlton's LINK—EXE program is fairware, and it is available from all the major information services or directly from Paul for a fairware fee. To obtain LINKER, send \$15 to him at 1599 Tibbets Ave., Troy, NY 12180-3723.

Al Beard, of LGMA Products and creator of 99 FORTRAN, went a step further and released a set of assembly EQUATES to standardize use of the XOP routines. He also wrote a simple Geneve DEBUG program, similar to TI's DEBUG program for the 99/4A. Another useful item by Beard is an article on memory management for the 9640. These are also on the information services, including Byte Magazine's BIXNET, where Al is a sysop. Beard placed these items in the public domain to encourage their widest possible use.

The efforts by these two master programmers are putting 9640 assembly programming within easier reach of those of us who learned some assembly programming on the 99/4A and would like to carry it over to the Geneve.

Rules to live by The Horizon RAMdisk meets the 9640

By BUD MILLS

Using any Horizon card with the Geneve requires a special set of rules depending on what you want the Horizon to do. These rules are dictated by the Geneve Operating SYStem.

First the Horizon BOOT ROS must respond to an 8-bit address code at a specific location to allow the Geneve to find and load the SYStem file. The 8-bit address code limits the Horizon as a BOOT drive to 256K.

Second, the HRD+ series of the Horizon card uses a 16-bit address code to address all available memory, depending on the size of card you build. The first 256K will respond to the 8-bit address code, so a 90, 180 or 256K HRD+ may be used as a BOOT Drive (with MENU7.3 ROS)

Third, the larger 384, 512 or 800K HRD+ are limited by the Geneve to 256K until we tell the Geneve to use a 16-bit address code and look at the Horizon as an 80-track disk drive. Then you can use DM3 to format up to 800K as an 80-track RAM-drive. The 800K is the limit of the 80-track 3200-sector drive.

As long as we obey the above basic rules, we can use the following combinations of the Horizon or HRD+ cards:

1. The 90K, 180K or 256K Horizon RAMdisk as a disk drive E: at CRU 1400 or 1600. (This can be used to BOOT the Geneve with the remaining memory used as a RAMdrive, max = 256K. The SYS file eats up 90K.

2. One 90, 180 or 256K Horizon as a
(See Page 33)

HORIZON AND THE GENEVE—

(Continued from Page 32)

BOOT only at CRU 1000 plus a HRD+ 384K, 512K or 800K card as disk drive E: at CRU 1400. This requires two cards and two slots in the P-box.

3. One HRD+ card that has both the 90, 180 or 256K BOOT drive and the bigger 384K, 512K or 800K RAMdrive — yes, on one card. Read on about the Phoenix mod.

Up to now it has been an either/or choice for utilizing the Horizon as a BOOT Drive (up to 256K) or as a RAMdrive (up to 800K). But now we have the Phoenix mod by Ron Walters that allows us to use “one

Horizon card” to do both tasks. The Phoenix HRD+ has two distinct RAMdisks, each with a separate ROS, and it all operates on the same CRU line on the same card. The software ROS is all loaded on the Phoenix HRD+ directly from the Geneve mode.

Many thanks to the following for their efforts which have helped develop the Horizon card to what it is today:

- Ron Gries, Dave Romer and John Clulow for the original Horizon RAMdisk
- Peter Hoddie for the original Geneve compatibility
- John Johnson and Mike Ballman

(Miami) for the MENU programs and adapting the Horizon card to the 32K CMOS and writing MENU 7.3 to control the large capacity HRD+ RAMdisk

- Jim Schroeder (Milwaukee) for the routines that allow the Geneve to address the HRD+ effectively to 800K

- Ron Walters (Aurora, Ohio) for combining all of the above into the Phoenix HRD+ to create the ultimate RAMdisk for the Geneve.

All of these HRD+ kits are available now from Bud Mills Services, 166 Dartmouth Dr., Toledo, OH 43614.

Myarc ships hard/floppy controller

Myarc's new hard and floppy disk controller card for the TI99/4A and the Geneve 9640 will be shipped beginning March 18, according to Jack Riley of Myarc.

The package includes:

- A hard and floppy disk controller card with streamer interface.
- MDM5, the Myarc disk manager, a menu-driven manager system that controls both floppy and hard disk drives.
- A manual with a three-ring binder.
- Cables to connect a hard drive to the TI or 9640.

The product comes in custom packaging similar to MY-Art but larger, Riley says, and retails for \$325.

He says it will support four floppy drives in single-sided, single-density through double-sided, quad-density format, 5¼” as well as 3½” disk drives.

“This (the hard drive) is running at 5 million bits per second,” he says, adding that the floppy transfer rate is 1½ million bits per second.

He says the disk controller will control three hard drives of up to 134 megabytes each for a total of 402 megabytes.

The streamer interface port will allow users to backup hard disks using a standard streamer tape unit. Additional software will be required for operation, however.

He says a low-power half-height hard drive can be put into the PEB by boosting the 12-volt power supply within the box.

For more information, call Myarc Customer Service in Alabama, (205) 854-5843.

More on the controller

By WALT HOWE

The new Myarc hard and floppy disk controller card was close to release as of this article with the finishing touches being put on the device service routines (DSRs) and the supporting software. I have had the use of one with my 99/4A system while writing documentation for the 99/4A version for Myarc. My test version has been running the DSRs from the GRAM Kracker. In the released version the DSRs will reside in an EPROM on the card. Mike Dodd has been writing the supporting software, and Lou Phillips of Myarc and John Birdwell (of DSKU fame) have had a hand in it, too.

For those who are considering buying the new controller, here are some things you need to know about the hard drive and power supplies required, whether you will use them with a 99/4A or a 9640.

The hard drive should be ST506/412 compatible. This is the type used with IBM-XT and their clones. It can be buffered or unbuffered, although the buffered type is faster. The size of the drive can be up to 135 megabytes or up to 400 in three different drives. They can be full height or half height, 5¼-inch or 3½-inch. Prices for some 20-megabyte drives are dropping well under \$200, if you shop around.

Do not plan on installing the hard drive in the PE Box, unless you are very sure of what you are doing! The PE Box power supply will not support a hard drive, cards, and floppy drives all together. Plan on providing a separate power supply for the hard drive. The best indicator of the power you need for different types of drives is the 12-volt supply. Depending on the type of drive, here are the usual power requirements:

| Physical Size of drive | Amperage of 12-volt line |
|------------------------|--------------------------|
| 5-inch Full Height | 5 amps |
| 5-inch Half Height | 2.5 amps |
| 3.5-inch Half Height | 1.5 amps |

With more than one hard drive, you do not need double the power, but do not turn the drives on simultaneously if the power is marginal. The greatest power drain is while the drive is building up to speed.

A 135-watt power supply is normally sufficient to provide what you need for a system, but to leave room for expansion, a 150-watt power supply is better.

(See Page 34)

Adding a hard drive to the PEB requires 2nd 12-volt power supply

This article details a method of powering a hard disk drive in the TI PEB. Readers are cautioned not to attempt this project without full understanding of this article. We encourage written questions about this article and will clarify the procedure based on reader feedback in subsequent editions.—Ed.

By ERIC W. BRAY, M.D.

So you want to be able to run a low power hard drive in your 99/4 peripheral expansion system!

With the near release of the Myarc hard/floppy disk controller, a lot of owners of the PEB would like to have a system that consists of just one floppy and one hard drive. That's the easy part. All you have to do is buy a half-height floppy and a low power half-height hard drive. However, you must be able to power both these drives while they are located in the PEB. That's the hard part!

As it is now configured, the PEB can't power them both at the same time, the reason being that the hard drive needs a constant 12-volt, 0.5 to 0.9 amp power supply to keep it spinning at 3600 RPM. Any drop in power if the two drives were using the same 12V power supply would cause the hard drive to shut down. There would always be a fluctuation in power if the two shared the same 12V when the floppy drives' motor began to run.

Now we come to the solution to this problem.

You are now proceeding at your own risk!

First obtain the following parts for the project:

1. One 7812 12-volt 1-amp voltage regulator.
2. One TO-220 heat sink.
3. Six feet of 18-gauge stranded wire.
4. Four insulated female solderless connectors.
5. Two male solderless connectors.
6. One solderless circular connector.
7. One 330uF capacitor.
8. One Y power connect for internal disk drives.

Remove all cards and disk drives from the PEB.

Next, disassemble the PEB. After this has been done, the project can be done in a matter of a few minutes. With the chassis of the PEB facing forward, you will see the exposed on/off switch on the lefthand side. Just to the right of this switch and in front of a bus bar there will be an empty space on the floor of the chassis. This is the working area for this project.

Now, here we go step by step!

1. Plug in the Y connector.
2. Plug in the PEB and turn it on.
3. Using a voltmeter, choose one of the power connectors and determine which is the 12-volt power supply wire to that connector. (It will be one of the two outside wires. The two inner wires are the ground wires.)
4. Turn off the PEB and wait two minutes!
5. Cut the 12-volt wire and its accompanying ground wire in the middle of the Y connection.
6. Attach a female solderless connector to each wire that exited the Y connector.
7. Attach a male solderless connector to each wire that goes into the connector plug.
8. Cut your six feet of stranded wire into two 30-inch lengths and one 12-inch length.
9. Attach a female connector to the end of each 30-inch length.
10. Attach the circular connector to one of these wires. (It's now the ground wire.)
11. Plug these wires into the two male connectors, being careful to make sure that the ground wire is connected to the inner connector.
12. Run these two wires back to the transformer area of the PEB.
13. Solder the negative lead of the capacitor to the ground lead of the voltage regulator.
14. Solder the positive lead of the capacitor to the output lead of the voltage regulator.
15. Solder the wire that is to go to the 12V supply of the drive to the output lead of the voltage regulator.
16. Solder the small 12-inch wire to the input lead of the voltage regulator.
17. Insulate the input and output leads

with shrink tubing, shrink tape or electrical tape.

18. Drill a small hole in the floor of the PEB chassis next to the on/off switch. Using a small nut and bolt, connect the 1) heat sink, 2) voltage regulator and 3) ground wire with circle connector to the chassis. (Make sure the nut is very tight!)

This is the hard part! (Get help if you need it.)

19. You will have to take the main circuit board away from its mounting and, keeping it oriented in the same direction in which it was mounted, find the unregulated 12-volt lead coming from the 12-volt regulator on the board. This regulator looks like a nickel with wings. The voltmeter reading should be around 25-26 volts on the unregulated lead. It should be the bottom lead.

20. Solder the other end of the short wire to this lead.

21. Mount the main circuit board back in its bracket and remount the bracket to the chassis.

22. Tape the two cut wires with the female plugs out of the way.

23. Turn on the PEB and using a voltmeter test your new 12V power supply. If you were successful, you will be reading 12V between your new ground and 12V wire!

Reassemble your PEB and you will be ready to add a hard drive to your system. You can run your two half-height floppies until you are ready to make your purchases.

CONTROLLER—

(Continued from Page 33)

The Hard and Floppy Disk Controller Card will support up to three hard drives, four floppies of up to 1.44 megabytes each, and streaming tape backup. A special cable will be required if you are running both internal and external floppies, since all must come from a single floppy connector on the card. These cables are easily fabricated from readily available parts. No soldering is required.

TELCO

A new terminal standard

By JOHN KOLOEN

Those who use modems with the 99/4A have always had to make choices when selecting a terminal program. For ease of use, Mass Transfer is hard to beat. Fast-Term provides additional features, such as disk cataloging, but to make use of the program's features requires the user to virtually memorize the documentation. Others, such as P-Term and 4A-Talk also provide alternatives, but in all cases each has its limitations.

But TELCO has changed all that. Written in assembly by Charles Earl, of Ottawa, Ontario, this new terminal program debuted on the major telecommunications networks in late February. From day one on it has generated a lot of excitement from users, and no wonder: TELCO is a full-featured terminal program that combines most of the features of all other TI terminal programs, and then some. Even more exciting is the fact that within two weeks of the release of Version 1.0, Version 1.1 was released. Version 1.1 incorporates a number of improvements suggested by initial users.

Performance: TELCO is a sophisticated program that some have compared to PROCOMM, one of the finest general purpose terminal programs available on PCs. While it is similar in design — using overlapping windows for menus and providing support for a large number of housekeeping and terminal functions — TELCO isn't nearly as large (in terms of bytes) as PROCOMM and thus not as extensive or as expensive.

TELCO requires a disk system and memory expansion and is compatible with the 4A and the 9640 running out of GPL. The program loads using Extended BASIC, Editor/Assembler, TI-Writer, Mini-Memory or Supercart. It comes as an archived file, and an archiver such as Barry Boone's Archiver II Version 2.4 is required to unpack it.

TELCO consists of about a dozen programs and files. The main program loads into memory and others are added into memory when required. Its organization is similar to Multiplan, which loads help files and directories into memory as overlays when needed. Because of this, the

Review

Report Card

| | |
|--------------------|---|
| Performance..... | A |
| Ease of Use..... | A |
| Documentation..... | A |
| Value..... | A |
| Final Grade..... | A |

Cost: \$20

Manufacturer: Charles Earl, 34 McLeod St., Ottawa, Ontario, Canada K2P 0Z5

Requirements: TI99/4A (or Geneve 9640), disk system, expansion memory, RS232 interface, modem, Editor/Assembler, Extended BASIC, TI-Writer, Mini-Memory or Supercart, printer and RAMdisk are optional

most efficient way of using the program is to keep the TELCO disk in DSK1 at all times. (TELCO can be used with a single drive system but it requires disk swapping between the program and data capture disks when various functions are accessed.)

Even though TELCO is sophisticated in terms of the number of functions it supports, it's not difficult to use. At most times, pressing FCTN 7 will call a window that lists keypresses and their results,

similar to FCTN 7 on Mass Transfer, except that this window isn't active on TELCO. The user has to leave the window and then initiate the function, but it still counts as being "user-friendly" in my book.

When I say "sophisticated" in describing TELCO, I mean that it provides the user with refinements that are missing from most other terminal programs. Take the logging function as an example. The log is opened and flagged with an LW (it marks data to capture from the line that the log is opened at) and when the line scrolls off the top of the screen it is flagged as LA, indicating that anything that scrolls off the screen will be saved to the log. When the log is closed, it is flagged LC, indicating that the line that the log was closed on has yet to scroll to the top of the screen. When it has cleared the top of the screen, the log is written and closed.

The log also has an LH flag, for hold. When the LH flag is invoked, data capture is suspended until the flag is removed and capture resumes. Additionally, the log function writes files in blocks of no more than 24K. But not to worry, TELCO automatically creates another log file using the same name as the first, only it adds a number at the end of the name. Thus, a log called SAVE1 would be incremented every 24K or so with SAVE2, SAVE3, (See Page 36)

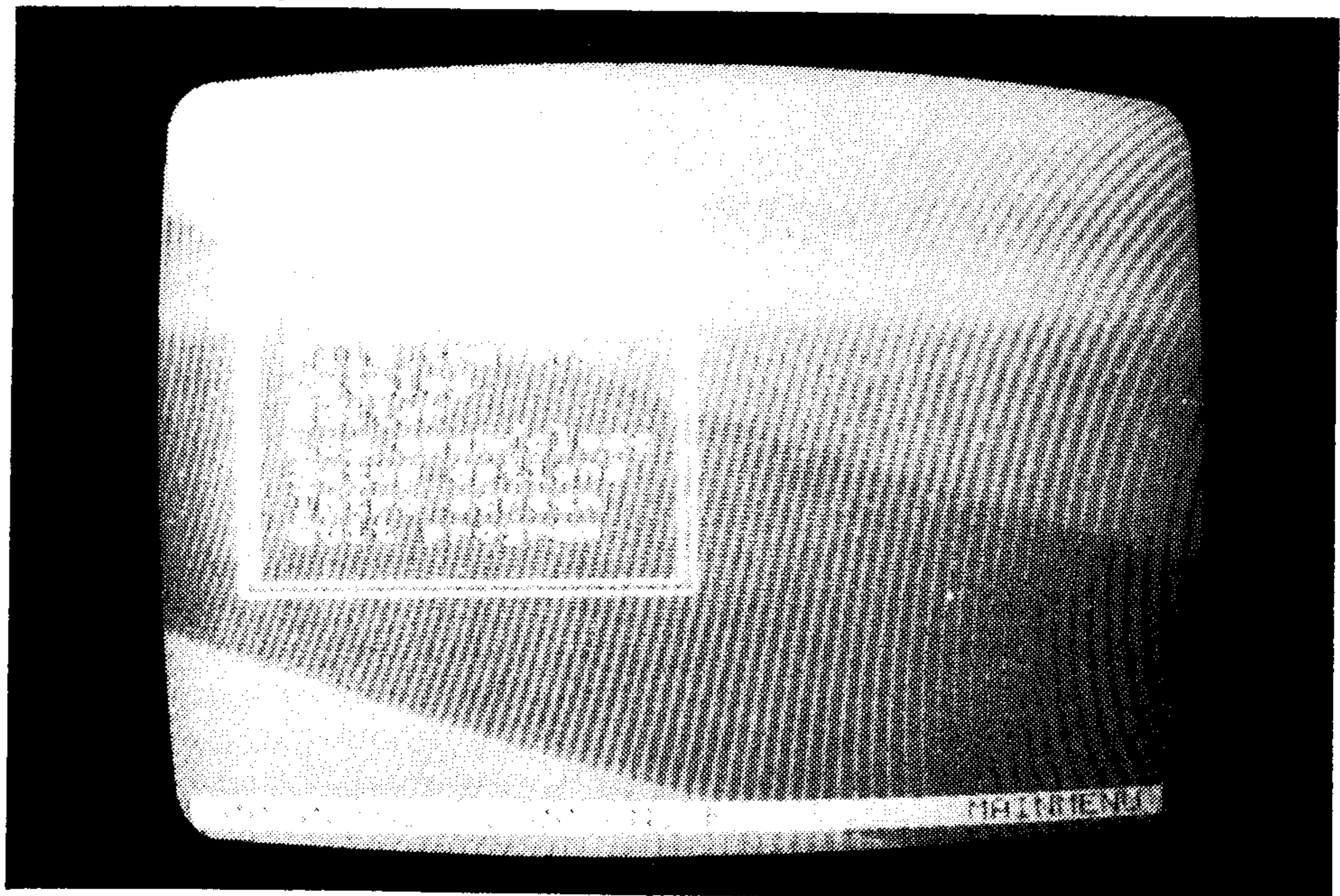

TELCO—

(Continued from Page 35)

SAVE4, and so on. Anyone who has ever logged a 160K D/V80 file will appreciate this feature. Of course, when downloading a file using XMODEM or ASCII protocols, the entire transfer is written to disk as one file.

The print spooler function operates similarly to the log function. The spooler can be toggled to send data to the printer immediately or delayed (data is sent after it scrolls off the screen), which is useful for receiving graphics.

The log and spooler flags appear on a status line at the bottom of the screen. The status line may be toggled on and off, but most users will keep it on. The status line includes the following items: elapsed time clock, baud rate, data bits, stop bits, parity, duplex (half or full), log status if on, spooler status if on, remote echo status if on and window lock if on.

Other features include, but are not limited to:

- Auto dialer that includes not only the phone number of the BBS but sets the defaults for baud rate (300 to 9600), parity, data and stop bits (8N1, 7E1 or 7O1) and terminal width (40 or 80 columns), with a maximum of 99 entries and the ability to automatically dial up to 15 numbers determined by the user;
- Macros, which can be called up at anytime and can be used to perform log-on procedures and enter IDs and passwords at a single keypress;
- Terminal emulation support for ANSI, D410 (Data General 410), and ADM3A (ANSI and ADM3A are the most popular) and limited support of VT100. The author has indicated that he will provide information that users can use to create their own files to support other terminal types;
- Disk functions, including rapid cataloging, deleting, protecting and unprotecting files and the ability to view a text file stored on disk;
- An editor that can be used to create D/V80 files that can be saved to disk. Files are limited to 50 lines by 80 columns and provides for cursor control, deletion and insertion by character and line;
- A Review Buffer function that allows the user to scroll through the contents of the buffer and dump a screen to a printer or other device at any time;

- Support for ASCII and XMODEM file transfers, including support for line-by-line ASCII transfers;

- The ability to establish defaults for a host of system operations, including whether to save or delete aborted downloads, foreground and background colors, inverse video for menus, sound effects (beep, chime or none) window width and position of left-most column to correct problems with various televisions or monitors, character and line pacing, default error checking method (CRC or Checksum), carriage return and linefeed translations, modem setup (initialization string, dial string, hangup string, echo time, redial pause time), and the list goes on, and on.

The only thing I fault is that in the auto dial function TELCO doesn't allow the user to set duplex for each BBS. Instead, this is set as a system default. This is easily changed, but it would have been consistent with the design of the auto dial function to have included duplex as one of the user-defined defaults. In fact, according to the documentation, the duplex setting is supposed to be set for each BBS through the auto dial defaults.

I've been using TELCO for about two weeks and I've had no problems downloading files or programs of any size. The only problems I had were related to my impatience with learning a new system. Even so, being able to call for help using FCTN 7 pulled me through in most cases.

Ease of Use: TELCO is not like any other terminal program for the TI. Its use of windows for menus means that the user always has information on screen to use when deciding what he wants to do next. The user also has access to all functions at any time. This makes it possible to run a catalog of a disk just before doing an XMODEM transfer to make sure there's enough room to hold the data. If there isn't, it's a simple matter of marking files to delete unneeded files, or replace the disk with another.

Documentation: TELCO comes with documentation on disk. It consists of several dozen un-numbered pages, including one page that is supposed to be returned to the author, along with a \$20 check for payment. The documentation is in the form of a D/V80 that the user dumps to a printer. It consists of nearly 250 sec-

tors. It is well-written and provides a wealth of information about telecommunications in general and TELCO in particular. It assumes that the user has some familiarity with terminal programs and telecommunications. It's well organized and literate but lacks a table of contents.

Final Grade: This program gets an A on every count, not only for what it does but for what it can achieve. A modular program, with overlays loading the defaults and functions when needed, the author is able to enhance it without having to rewrite the entire program. (Not that it isn't already enhanced.) An example of this is how quickly he went from Version 1.0 to Version 1.1

I know there's a number of things I haven't even touched on — the fact that macros can be linked is one of them — but that's what makes this such a wonderful program. There's plenty to crow about on the surface, what's underneath is discovered only after using it for awhile.

Comparing TELCO to other terminal programs is pointless. I'd say it represents the attainment of a new plateau for terminal programs for the TI.

The program is currently available on the major networks or by ordering directly from the author, but it deserves to be distributed on a wider basis. While it is classified as user-supported software, and is fully copyrighted with all rights reserved by the author, the author must still rely on the honesty of the user if he's to be paid. My hope is that the hundreds who have downloaded it already will send the author \$20 each. Not only is the program worth the \$20, we need to encourage Mr. Earl to do more.

Boards listed

R.N. Boyce Jr. operates three bulletin boards which support both the TI99/4A and Myarc 9640 with special messages and file areas. All three are free, open access systems. The Dedham, Massachusetts, board at (617) 329-8528 runs 24 hours at 300/1200/2400 baud. The Newport, Vermont, boards run on a multi-user system with 80 megabytes of storage and both lines access all file areas. Numbers are (802) 334-7976 (300/1200 baud) and (802) 334-7975 (300/1200/2400 baud).

String Master

Subprograms focus on strings

By JOHN CLULOW

String Master is a collection of 29 subprograms used to enhance TI Extended BASIC. The software will also work with Triton and "GK" Extended BASICs, but it will not work with Myarc Extended BASIC. As the name implies, the central focus of the collection is upon manipulation of strings and particularly string arrays; functions such as sorting array elements, searching an array for a specified string, saving and restoring data from screen display windows, trimming unwanted characters and rotation of string array elements.

The routines are written in assembly language, and will normally be loaded into a section of memory unused by Extended BASIC: They can be used without reducing available program or stack memory or otherwise altering the Extended BASIC environment. At the same time, assembly language provides the ultimate in speed.

CALL LINK statements execute the subprograms. For example, to access the routine called BEEP, the statement CALL LINK("BEEP") is used. When information must be provided for a subprogram to operate, it is supplied in a series of parameters following the routine name. For example, FRAME draws a hollow box around a "window" on the screen. To use FRAME you specify the upper left and lower right corners of the box and the character pattern to be used. To draw a box with row 3, column 2 as the upper left corner and row 10, column 15 as the lower right corner and using an asterisk (ASCII 42) as the border:

```
CALL LINK ("FRAME",3,2,10,15,42).
```

The String Master manual is very well written and easy to use. The subprograms, listed in alphabetical order, are each thoroughly described. All descriptions follow the same format. The CALL LINK syntax for a subprogram is followed by a description of each parameter, references to related String Master subprograms, routine usage, application notes, things to be careful of when using the routine, and one or more examples of use of the subprogram.

Although the manual is very good, I felt that application notes for several of the routines were not explicit enough for me and perhaps for the average user. However, it

Review

Report Card

| | |
|--------------------|---|
| Performance..... | A |
| Ease of Use..... | B |
| Documentation..... | B |
| Value..... | A |
| Final Grade..... | A |

Cost: \$19.95

Distributor: Bytemaster Computer Services, 171 Mustang St., Sulphur, LA 70663-6724

Requirements: 32K memory, disk drive, TI or compatible Extended BASIC.

is also quite possible that this reaction says more about my own deficiencies than those of the String Master manual. So while I feel obliged to describe my impression, remember that you might have an entirely different reaction.

One example would be the subprogram CONCTR that concatenates or adds the elements in one string array onto the right side of the corresponding elements in another string array. While the description of how to use this subprogram is quite clear, I found that the application note, "Useful in database operations," left me wondering what I would ever use something like this for. I am sure there must have been several specific ideas the author had in mind when he wrote the routine, applications which, once explained to me, would appear obvious. But the application note is not of much help. After some thought, it occurred to me that this routine could be of use in building index files for a database, but I have to wonder what else I'm missing.

Another example, APENDA, is probably the most complex subprogram in STRING MASTER. It uses 16 parameters. This routine can be used to copy elements selectively from one string array into another and even back into itself. You can start at any array element in either array; the first element in the "source" array can be copied into the 15th element in the "destination" array, for example. You can specify that only a certain segment of the source array gets copied, and even specify

that it is only copied if a specified logical condition is met. In addition, you can use parameters to keep count of the number of elements copied or of the number of elements that meet the logical condition without copying them.

It took me about half an hour to understand how this subprogram works, and then I was left with the question of what kind of applications I might actually use it in. The application notes say it is "Useful for database operations in which a field is derived as a SEG\$ of a string...to obtain counts of strings matching certain criteria...and clever manipulations of character patterns." Although I usually think of myself as a rather clever person, APENDA now has me wondering: Maybe they should have called it HUMILITY.

For the majority of subprograms in STRING MASTER, though, no application notes are needed, even for me. For example, there are three different sorting routines, SORTA, SORTAN and SORTD. SORTA and SORTD perform ascending and descending ASCII sorts one one-dimension string arrays. SORTAN is like SORTA except that it puts null string elements (those with nothing in them) last.

These routines are designed to handle one-level sorting. However, in many instances you can achieve a multilevel result by constructing array elements from concatenated strings. To build an index file sorted by zipcode and then by last name, for example, you could first put zipcodes in an array, then use CONCTR to add last name to the end of each zipcode, then use FIXLEN to make all elements the same length, and finally use CONCTR again to add the record number to the very end. When this array is sorted, last names will be sorted within zipcode, and record numbers will be carried along at the end of each element to be used subsequently in relative file access.

Another routine that could be useful in a broad range of applications is SEARCH. With this routine you can search up to a seven-dimension array for the first occurrence of a specified string. SEARCH will find strings that are embedded in array elements. Because the element with which

(See Page 40)

Epson LX-800 printer

Lots of features at a small price

By Chris Bobbitt

©1988-All Rights Reserved

It was finally time to replace my old Gemini 10X. After five years of very hard duty — thousands of letters, listings and rough drafts — it died one morning in its sleep (while turned off that is).

The Gemini wasn't my only printer. Two years ago I picked up an HP Thinkjet printer at a computer store's going out of business sale. The HP is a marvel! Only about 5 pounds, it comes with a built-in printer stand; it's fast (its 160 cps was really impressive 2 years ago), and is so quiet all you hear is the rustle of the paper as it prints. On the down-side, it isn't quite Epson compatible (so graphics were often printed "funny"), the replacement ink cartridges were expensive if they could be found at all, you needed special inkjet paper, and inkjet labels were non-existent. So much for my attempt to "Buy American."

I still use the Thinkjet, but I also need a general-purpose printer that can do everything from labels to Epson graphics. My old Gemini filled that void until it died.

I actually started looking for a printer long before the Gemini gave up the ghost. It wheezed along with paper-clip and banda-aid fixes for a long time while I read reviews, and looked around. Before I went shopping, I made out a list of what I wanted in a printer.

First, I wanted something that was under \$300 — what I paid for the Gemini. I wanted something that was 100 percent Epson-graphics compatible. All the best graphics programs for the 99/4A (as well as most computers) support Epson graphics. Next, I wanted something fast. Fourth, I wanted a printer where I could find paper and ribbons for it anywhere. Also, I wanted something that I could buy from a local dealer. I have had more trouble than I care to mention with hardware purchased out of the pages of glossy computer magazines from dealers used to stealing from gullible clone buyers, yuppies, young children, and other uninformed types. Finally I wanted a 24-pin printer.

In scanning the magazines I soon found the only 24-pin printers for under \$300 were by Eddie's Printers and Used Auto

Review

Report Card

| | |
|--------------------|---|
| Performance | A |
| Ease of Use..... | A |
| Documentation..... | A |
| Value..... | A |
| Final Grade..... | A |

Cost: \$200-\$250

Manufacturer: Epson America Inc.,
2780 Lomita Blvd., Torrance, CA 90505

Requirements: parallel printer inter-
face, cable

Parts, and similar vendors. Since I wasn't interested in purchasing something from a manufacturer that I didn't recognize, I soon gave up the fantasy of a cheap 24-pin, Epson-compatible printer that was fast and I could buy locally. I settled on the older 9-pin technology. Proven printer technology with a proven computer seemed like a good match to me (or at least a safe one).

This narrowed the field dramatically. I soon boiled my list down to the bottom of the line Epson, Seikosha, Panasonic and Star Micronics (alias Gemini) printers. Then it was a case of comparison shopping — and time for a trip to the dealers.

After going to a few computer stores that wanted much too much for a printer, I went to the local store of a chain that sells only printers and advertises heavily in several computer magazines. They had the best locally advertised prices for the printers I wanted to evaluate, and their mail order prices were even lower. I clipped one of their ads from a particularly over-sized computer publication, and took it with me to see if they would give me a printer at the magazine advertised prices.

When I walked in the door a large crowd of holiday shoppers gave me ample opportunity to look over the specification sheets and manuals for the printers I was interested in without being assaulted by over-anxious salesmen. Before the salesmen noticed me, I was leaning heavily toward the Epson LX-800.

The thing is fast, up to 180 characters

per second in draft mode and a respectable 30 cps in near-letter quality. It uses standard ribbons, the cable from my departed Gemini would work with it without alteration, it uses standard paper, it comes with a simple page feeder as well as a removable, adjustable tractor feed unit. It has the Epson name (if TI and IBM both trust them to make printers for them they had to be good), of course it is Epson-graphics compatible (as well as IBM graphics, whatever that is), and it is about \$200. The LX-800 blew away all the competition in price, performance, and all the features I was most interested in. The only thing that made me hesitant was, ironically, the price. How could \$200 printer be THAT good?

By the time I was ready for a demo most of the crowd had departed, and the salesmen started looking like they were in the mood for another feeding frenzy SOON. Four of them raced to me when I put that purposeful "I could use some help" look on my face. Out of breath, the fastest beat away the other three and introduced himself. After trying to sell me the most expensive printer in the place, we got down to what I wanted.

I told him I was interested in a demo of the Epson LX-800. He took me into a showroom area where all the printers were connected to a central computer, which sends demonstration pages of text to each of the printers. He then asked me what I was using it with. This is the part I dread: Usually when you tell them it's for a 99/4A they start looking at you as if you are a street person and you just walked into the most expensive French restaurant in town. I was determined to bear it out this time, and nonchalantly (I hoped) told him that it was for a "Texas Instruments Home Computer." Instead of instant frost, I got a look of surprise!

The salesman explained that he had had a fully expanded 99/4A for years, and that he had belonged to the Annapolis chapter of my users group and knew such notables as Chris Faherty (author of TI-Artist).

He went over to the Epson, and ran a demo. After printing out a sheet, of poor looking text, he brightened up and pointed

(See Page 39)

LX-800—

(Continued from Page 38)

to a printer a few feet away. "Brand X is not only much better and as fast but it is only \$80 more", he proclaimed. Brand "X" turned out to be a generic printer that, once he punched a button on the demo computer, produced an admittedly very dark and nice looking sample. He ripped off both samples and handed them to me and said triumphantly, "Compare!"

While I was looking he reeled off a stream of facts. First, he said, the Epson LX-800 didn't do italics or double-wide text in near-letter quality (both of which I knew from looking at the printer manual earlier were false), and that Brand "X" was 100 percent Epson compatible. His obvious desire to sell me "X" made me suspicious.

At the end of his spiel I asked him if I could compare the manuals for the printers. As I suspected, he had to go in the back and get the one for "X" (which I hadn't seen up front earlier). While he was away, I inspected the demo units. As I suspected, the ribbon in the Epson was almost worn-out while the one in "X" was practically brand-new. Also, the sample from "X" was deliberately far more ornate than the Epson one. Finally, the Epson sample re-stated the nonsense the salesman mentioned earlier. The whole situation had all the elements of bait-and-switch, except that they weren't out of LX-800s.

I made up my mind there to buy the Epson, but I wanted to see how far the guy would go. I then inspected the manuals.

The codes for both were almost identical. They both had high density graphics (240 dots/inch), they both had most of the same graphics commands, they both had emphasized, condensed, double-width, superscript and subscript modes. They both had an elite pitch (12 characters per inch) and a pica pitch (10 cpi). They both were bi-directional. "X" had a reversible carriage, which I suppose is a useful feature but I don't know of any software that could use it. On the surface they had most of the same features.

However, "X" fell short in a few ways. For one it didn't have the proportional graphics mode of the Epson (something found in more recent Epson printers which gives you as many graphics dots vertical-

ly as horizontally to the inch). It also didn't have the "dump mode," which is incredibly useful to programmers (it gives you a list of all the ASCII values as it receives them from the computer). The LX-800 also had definable characters while "X" didn't. Finally, The Epson has both a Roman and Sans Serif fonts available in NLQ, draft mode, italics and double-width text, or any combination thereof. "X" was lucky to have a NLQ mode at all.

As for the manuals, the "X" manual was written in "Japlish," or the dialect of English unique to Japanese consumer electronics. The LX-800, on the other hand, has an excellent manual arranged in easy-to-read sections. It has one of the most complete explanations of printer graphics of any printer manual I've ever seen (which is always a test of how well-written a printer manual is). It also has numerous appendices that cover the hardware, the interfaces, a summary of all the commands (with the codes to be sent to the printer in both hexadecimal and decimal format), a well-done character table, as well as complete technical specifications that would be a joy to hack a cable from. Also, unlike some manuals, it has a reasonable index and a full table-of-contents. It even has a cut-out, quick-reference card with both a listing of features and the codes needed to get them as well as all of the DIP settings. Finally, it was well written.

The Epson LX-800 manual was obviously superior, but how about the printer itself?

I went back (with the salesman tagging along) to the printers and gave them a serious examination. The Epson LX-800, like most printers and computers nowadays, is made from a high-impact plastic. However, the similarity between them ends there. The LX-800 is sort of low, like a sports car, and has a reasonable sized footprint (about 12 x 15 inches).

It comes with a number of standard pieces, some of which I've never seen for other printers except as options. It has a paper rest, which is confusing at first. It plugs into the back of the printer and keeps the paper from flopping over on the cable and power-cord.

It also comes with a paper-separator, which with the addition of two matching

snap-on edge guides, as well as an intelligently designed rest for the guide, can be stood on end and used as a paper-feed for single sheet printing. The edge guides are so innocuous that I leave them snapped on all the time, even when I'm using the thing as a paper separator (when the guide is laying horizontally). The printer has a lever that you use to switch the printer between friction feed (for single pages) and tractor feed.

The only part of the LX-800 that is somewhat ill-designed is having to remove the tractor feed unit everytime you want to switch tractor paper and single sheets. The tractor unit isn't tough to remove. It snaps in and out of place easily and yet holds with enough force that I don't think it will ever fall off by itself, it's just sometimes a pain to switch between the two when you are concentrating on a job. However, unlike any other printer I've had, it does come with a rudimentary page feeder, as well as a button you can press that will automatically grab the paper and load it for you if you just drop a sheet into the feeder. Pretty impressive, actually.

The LX-800 uses the standard Epson FX cartridge ribbon that is so ubiquitous it's scary. It also has a sophisticated button panel that will let you access virtually all of the most often used features of the printer without sending any codes from your computer. By pressing the right combination of buttons you can select NLQ in either of the two NLQ fonts, or draft printing, in emphasized, double-strike, condensed or elite. Of course you can also press a button for a form or line feed. Finally, the LX-800 also has a 3K buffer.

As you may have guessed, "X" fell short in a lot of these areas. I guess it takes years of conscientious design (as well as feedback from thousands of owners) before you start paying as much attention to the details as Epson has done with the LX-800.

The salesman was undaunted, and was undoubtedly interested in the extra commission he received for selling this no-name printer. It was time to break it down into dollars and good-sense. First I asked him about ribbons. He informed me that "X" ribbons were only \$10 each and the Epson ones were \$15 from his store. What he actually implied is that "X" uses a

(See Page 40)

STRING MASTER—

(Continued from Page 37)

the search begins is specified in the parameter list, you can use SEARCH repeatedly to find multiple occurrences of the string in an array.

The WINDOW subprogram is another general purpose routine. It allows you "instantly" to save the contents of a specified screen window in an array or to display a window previously saved. Together with the FRAME routine mentioned earlier, WINDOW can be used to advantage in most Extended BASIC programs. As in the FRAME example, the parameters include the row and column for the upper right and lower left corners of the window, a "W" or "R" for Write or Read, and the name of the string array to be used.

SELECT is a unique subprogram that allows you to review the contents of an array by "stepping through" the elements using either the up and down arrow keys or a joystick. One of the parameters in the SELECT statement is the beginning screen row for display or the array elements. If you keep an arrow key depressed, the stepping process auto-repeats, picking up speed the longer the arrow key is held down. When the ENTER key or a joystick fire button is pressed, the subprogram returns to Extended BASIC with the number of the array element selected.

In addition to these kinds of routines, STRING MASTER has several subprograms that are useful for more advanced application. SMPEEK and SMPOKE, for instance, allow you to read bytes from CPU memory and store them in a string array. The number of bytes you can read on a given access is limited only by the amount of string space available. The analogous SVPEEK and SVPOKE are used with VDP RAM.

After you have read data using SMPEEK or SVPEEK, you can then do conversions among number bases. The subprograms BINHEX, HEXBIN and HEXDEC make such conversions very easy, and convert all elements of an array with a single CALL LINK.

Other STRING MASTER subprograms not mentioned above include: CIRCUL — circulates elements in an array; CONCTL — like CONCTR, only concatenates on the left side of array elements; EOANN — finds the last array element that is not emp-

ty; MAXLEN and MINLEN — return the longest or shortest string in an array; REPLACE — used to search an array replacing every occurrence of a string with another string; and one of my personal favorites, HONK — created especially for Canadian users, perhaps.

In summary, Extended BASIC programmers who are working with applications that use string arrays will find that String Master lives up to its name.

LX-800—

(Continued from Page 39)

custom ribbon that he said is the same as that for a Legend printer, whatever that is. I also pointed out the fact that if you don't buy a name-brand ribbon you can get one for under \$5 anywhere. The Legend ribbon could only be bought from this dealer, and who knows how long they would stock it? He suggested that I could re-ink the ribbon by hand, and I gave him a dirty look.

Next, we went on to service. Epson printers are well-known for reliability. The LX-800 has a six-month warranty, which is none-too-generous, but Epson has service centers all over. "X", on the other hand, had a six-month warranty with this store, which also was the service center for the printer. Also, for \$100 more they would sell me a "service contract" that would entitle me to an additional year of service. I took great pleasure in explaining how computer stores go in and out of business all the time, but large manufacturers rarely do.

I finally told him that I was going to take the Epson. Crestfallen, he led me to the back and handed me the printer and we trooped up to the cash register. At that time I pulled out the ad I clipped and asked if I could have the printer for the computer magazine advertised price — which was about \$30 below what he wanted for the LX-800 at the store. The salesman got a worried look and called the manager, who explained to me why they had to charge \$30 more for taking up space in their industrial-park located store. My argument that I could call their 800 number and pick it up from their warehouse if necessary cut no ice with them — I was informed if I ordered the "mail order" printer I would

have to receive it by mail. I then wrote out a check for the full price, and left with my new toy.

Since I set it up two months ago I've printed out hundreds of pages of complex graphics, documents and letters. The Epson has performed flawlessly. While dot-matrix printers are loud in general, this one is much quieter than the machine-gun sounds the 10X used to make, and the backfire-like sound of your standard letter-quality printer. At night I use my inkjet anyway, which makes less noise than an average TI disk drive.

I'm very impressed with the LX-800. I'm even more impressed with the fact it's by Epson, which until now I considered to be more interested in producing up-scale printers than bottom of the market ones. If Epson continues to produce low-end printers like the LX-800, not only will the company change the definition of "low-end" (printers with this many features cost over \$1,000 when I bought my Gemini), but they'll also give their competition a lot to worry about.

If your Gemini or TI printer is nearing the end of its life-expectancy, or you are just buying a printer for the first time — take a serious look at the Epson LX-800, and don't buy it from a local printer store that has its own generic brand (unless you don't mind suffering hard-sell sales tactics).

User Supported Software

(Continued from Page 29)

out of Extended BASIC. The program allows the user to sort, search, enter data, define databases, etc. The program includes a manual on disk and help screens. The author is also distributing a disk/book combination called *The Programmer's Inspiration Book* that includes a number of programs and documentation files. Send four SSSD or two DSSD disks for the disk/book and Records/Plus, return mailer and postage. Donations of up to \$10 are encouraged.

GRAPHICS

Boyd Shugert, 1729 Timmonds Ave., Portsmouth, OH 45662, is offering a floppy containing graphics for the Axiom GP-100TI, Smith-Corona Fastext 80 and Epson-compatible printers. The author's method of preparing the graphics in BASIC and XBASIC is also documented. The disk includes a printer program that will output the graphics in normal or reversed view, single or double size. There are 17 graphics included on the diskette. The author says he created this method of designing and outputting graphics so that he could printed customized graphics on a printer

(See Page 46)

Newsbytes

New BBS founded

A new TI-supportive bulletin board is being run by Michael Dorman, a member of the Mid-South 99 User Group.

The board is called the Midnight Hour BBS and operates 24 hours a day at 300/1200 baud. The board is operated on an IBM system with a hard drive but primarily supports the TI99/4A and Geneve 9640 with a download section and message bases. The board is operated in West Memphis, Arkansas, at (501) 735-9980.

Printer control book published by McWare

McWare Products has published a new book called *How to Control Any Printer from Any Computer*, as part of its McWare printer control series.

Written as a workbook for instructional purposes, the book is described as providing examples and discussions. It contains an appendix with information about the printer control codes from many printers including Gemini 10X, Legend 880, Alps 2000, Fastext 80, Star NX10, Star NP10, Panasonic KX-P1091 and Okidata.

The book is available for \$14.95 plus \$2 shipping and handling from McWare Products, P.O. Box 2784, Fairfax, VA 22031.

Legends upgraded

Asgard Software, Donn Granros and Ed Johnson have announced Version 1.1 of the graphics role-playing game, Legends.

The new version corrects all errors round in the previous one, according to the manufacturer, and also contains the following new features:

- Multiple attacks: Each character now is "capable of striking the bad guys twice in each turn," the manufacturer says. As the character's level increases, his or her number of "attacks" increases. Monsters also have multiple attacks based on their difficulty level.

- Time delay: This feature allows the user to set the duration messages last on the screen, for the convenience of advanced users who already know all the messages and Geneve users who want to slow them down so they are readable.

- Save game: This feature allows the user

to save the game without returning to Wizard's Rock. The game cannot be saved in a dungeon and quits after saving, so a user who wants to continue must reload the program.

- New potion — Stealth: This potion allows the party to become invisible. The manufacturer notes "unfortunately you can't really tell when you'll become 'invisible' again."

- New spell — Slow: This spell allows Rangers and Wizards to reduce the number of times a monster can attack to one per turn. Some monsters have this spell, too.

- Terrain types: Where the player treads can now mean the difference between "electronic life and electronic death." The four terrain types in order of deadliness are grasslands, forests, swamps and dark swamps.

- Monsters: Many have been changed and made more dangerous.

Also, the manufacturer says, the user now has the option of engaging in combat or not in most encounters, the Island graphics have been enhanced and the difficulty level determines not only the type of monsters encountered, but how much gold and experience the player gets for killing them.

Current users may receive new disks plus a manual update covering the new functions by returning their original disks plus \$5. Cost of Legends 1.1 is \$27.95.

Orders may be sent to Asgard Software, P.O. Box 10306, Rockville, MD 20850.

Nameloc releases Graphic Lister

Nameloc Software of Portland Oregon, has released Graphic Lister, a program designed for use with TI-Artist.

The program will print out lists on 1-inch and 1½-inch labels, 3x5 cards, 4x6 cards, 8½x11 pages or other sizes.

The program allows the user to put a message on one side of the paper with TI-Writer, then run the paper through on the other side and print out all the addresses with the return address. The paper can then be folded, stapled and stamped.

Graphic Lister contains the following programs:

- LISTMAKER, an Extended BASIC program with which the user can build, edit

and save mailing lists to disk.

- Three c99 programs which load out of Editor/Assembler option 5, "Run Program File" to print out lists:

- "ONE" (files ONE, ONF, ONG): prints in any 1x1 character TI-Artist font or built-in printer fonts; incorporates TI-Artist instances up to 12 rows by 10 columns.

- "TWO" (files TWO, TWP, TWQ): prints with the built-in printer fonts; incorporates small instances (up to 7 rows by 5 columns).

- "THREE" (files THREE, THREF, THREG): prints text in either any 1x1 character TI-Artist font or the built-in printer fonts; incorporates TI-Artist instances up to 12 rows by 10 columns.

- CONVERT — an Extended BASIC program that will convert a previously built LABELMAKER list.

- LIST — a short "phony" practice mailing list.

- LOAD & LAR — a fairware Editor/Assembler simulator that loads automatically from Extended BASIC, included for the convenience of users who may not have the E/A cartridge.

- DOCUMENT — complete documentation for all the programs.

Graphic Lister is available for \$10 plus \$1.50 shipping and handling from Nameloc Software, 3971 S.E. Lincoln, Portland OR 97214.

IBM-Okidata switch

The UKI Switch Corporation, 326 Linden Place, West Hempstead, NY 11552, offers the UKI printer switch, a small plug-in circuit board with an EPROM which contains both the Okidata command set and the IBM Plug 'n' Play options. The switch is particularly useful to those with older Oki's that don't support IBM commands.

UKI sells different configurations for various models, including the Microline 83, 92/93 and 192/193. The switch costs \$49.95.

Newsbytes is a column of general information for TI99/4A users. It includes product announcements and other items of interest. The publisher does not necessarily endorse products listed in this column. Vendors and others are encouraged to submit items for consideration.

User Notes

Clarifications on Print-A-Tag

Edward S. Machonis, of Floral Park, New York, responds to two issues regarding his Print-A-Tag program published in the December issue.

I was amused to see the User Note by Wanda Clark in the January issue. Similar code was deleted from an early version of Print-A-Tag to make it a little friendlier. The additional key presses introduced for each label change — Y, ENTER and R — seem to more than offset the five or six key presses saved for those few times when a label is reprinted with no change in aspect or quantity.

The program was deliberately designed so that any print quantity greater than one had to be entered for each run in order that the printer was not unintentionally started on a longer run than desired. (It originally defaulted to the previous quantity entered.)

I guess it's all in one's point of view, and what appears to be a defect to one person becomes a "slight improvement" to another. Incidentally, to run another set of labels, one only has to press Enter for each default and enter a new quantity if more than one label is desired.

Correspondence forwarded from a reader using a Prowriter informs me that the graphics were inverted on his labels. This is due to Prowriter assigning binary values to the print head pins opposite of those used by Epson. Prowriter's least significant bit is Epson's most significant bit, and vice versa. Below is a listing of the line numbers and the changes required therein to print the graphics right-side up on the Prowriter.

In order to determine the new values required, the TINYGRAM listing below was developed. It prints a table of the equivalent bit values for each printer. The table is bidirectional; the first number can represent either printer and the second value will be the equivalent for the other printer. These may be useful to other Prowriter users in converting Epson graphic codes.

```
1 ! PRINT-A-TAG CHANGES REQUIRED TO RESTORE INVERTED GRAPHICS PRINTED WITH PROWRITER PRINTERS. !127
```

```
180 H$=K$&&RPT$(CHR$(28),2)&RPT$(CHR$(62),2)&RPT$(CHR$(124),4)&RPT$(CHR$(62),2)&RPT$(CHR$(28),2)&" " :: B=1 !184
260 B$=K$&&CHR$(32)&CHR$(48)&CHR$(56)&CHR$(60)&CHR$(190)&CHR$(255)&CHR$(190)&CHR$(60)&CHR$(56)&CHR$(48)&CHR$(32)&CHR$(0)&" " :: GOTO 330 ! XM AS TREE !253
```

```
280 B$=K$&&RPT$(CHR$(96),2)&RPT$(CHR$(112),2)&RPT$(CHR$(63),2)&RPT$(CHR$(2),2)&RPT$(CHR$(28),2)&RPT$(CHR$(0),2)&" " :: GOTO 330 ! MUSIC NOT !065
```

```
290 B$=K$&&RPT$(CHR$(66),2)&RPT$(CHR$(98),2)&RPT$(CHR$(31),2)&RPT$(CHR$(50),2)&RPT$(CHR$(100),2)&RPT$(CHR$(0),2)&" " :: GOTO 330 ! WALKER !165
```

```
320 H$=K$&&CHR$(60)&CHR$(66)&CHR$(145)&CHR$(165)&RPT$(CHR$(161),4)&CHR$(165)&CHR$(145)&CHR$(66)&CHR$(60)&" " :: GOTO 330 ! HAPPY FACE !059
```

```
1 ! *** EPSON/PROWRITER ***
* Graphics Print Code *
* Conversion Table *
* A TINYGRAM *
*** by Ed Machonis ***
```

```
!150
2 INPUT "PRINTER? EPSON=1 PROWRITER=2 (1 OR 2?) ": X :: P$(1)=CHR$(15) :: P$(2)=CHR$(27)&"Q" :: OPEN #1:"PIO", VARIABLE 132 :: PRINT #1:P$(X)!205
3 FOR R=0 TO 31 :: FOR C=0 TO 7 :: E,N=R+C*32 :: P=0 !132
```

```
4 IF INT(N/2)<>N/2 THEN P=P+128 :: N=N-1 !038
```

```
5 IF INT(N/4)<>N/4 THEN P=P+64 :: N=N-2 !249
```

```
6 IF INT(N/8)<>N/8 THEN P=P+32 :: N=N-4 !254
```

```
7 IF INT(N/16)<>N/16 THEN P=P+16 :: N=N-8 !100
```

```
8 IF INT(N/32)<>N/32 THEN P=P+8 :: N=N-16 !096
```

```
9 IF INT(N/64)<>N/64 THEN P=P+4 :: N=N-32 !100
```

```
10 IF INT(N/128)<>N/128 THEN
```

```
P=P+2 :: N=N-64 !203
```

```
11 IF N>127 THEN P=P+1 !192
```

```
12 PRINT #1:TAB(C*16+8);E;" ";P;:: NEXT C :: NEXT R !217
```

More on checksum

This comes from Jim R. Van Scyoc, of Hayward, California. He writes:

In the User Notes in January, you printed an item by Frank Geitzler titled "Checksum update." Frank refers to a bug in the program causing the screen to scroll after entering the input file name. If you think about it, you will remember that the screen is not supposed to scroll when using the ACCEPT AT statement.

The bug can occur when you run any program with ACCEPT AT in it while the checksum object code is resident in memory and the interrupt routine is turned on. If you or the program execute a CALL LINK("OFF") or CALL INIT the problem will disappear. Executing a NEW will not help. Possibly the object code could be changed, but I will leave that for a machine language programmer.

I'm including a minor change I made to the input and output defaults in the checksum program. Why type "DSK" every time? If you always save the merge files under the default name CHECKIN and CHECKOUT, you can do the whole input and output with two keystrokes.

The cursor will now rest upon the number allowing you to change the default drive and the file name with the least number of keystrokes. We then add DSK to the filename in the OPEN statements. I am always willing to put in a few extra keystrokes programming to save a few strokes while running a program.

```
130 DISPLAY AT(10,1):"INPUT MERGE FILE?": " DSK1.CHECKIN" !003
```

```
135 ACCEPT AT(11,6)SIZE(-12) BEEP:1$ :: OPEN #1:"DSK"&1$, VARIABLE 163, INPUT !036
```

```
140 DISPLAY AT(13,1):"OUTPUT MERGE FILE?": " DSK1.CHECKOUT" !202
```

```
160 ACCEPT AT(14,6)SIZE(-12) BEEP:0$ :: OPEN #2:"DSK"&0$, VARIABLE 163, OUTPUT !153
```

(See Page 43)

User Notes

Chart is key to TI-Artist

This comes from Jon Hodges, of Richardson, Texas. He writes:

I would like to respond to the Feedback letter from Elton Schooling regarding TI-Artist V2.01. If he looks on the third page of his manual he will see a "Key Layout" that describes the keys that require FCTN to access the designated operation. This is the only place in the manual that even hints at the use of several keys, and it does not do so clearly. The key combination he wants to slow cursor speed is FCTN semicolon.

Last year I taught TI-Artist at a Mini-SIG for our user group and made up the enclosed chart.

We hope readers who use TI-Artist will find this chart to be a handy reference.

Decimal numbers converted

The following program, by James Aaron, of Norwalk, California, will convert a decimal number to any desired one or two digit base as long as $LEN(A\$)=(BASE\ VALUE)$ and the decimal number does not exceed $(BASE\ VALUE)*10^{12}$. Any value greater than this will not be reliably converted. For example, $2*10^{12}$ will be accurately converted to a 41-digit binary string, but $2*10^{12}+1$ and $2*10^{12}+2$ will convert to the same string. For bases greater than 32 just extend the length of A\$. For bases greater than 99 the decimal value must not exceed 14 digits and meet the above parameters.

```
10 CALL CLEAR :: A$="0123456
789ABCDEFGHIJKLMNPOQRSTUVWXYZ" :
: DISPLAY AT(11,1): "BASE: " :
: "NUMBER: " !082
20 ON WARNING NEXT :: ACCEPT
AT(11,7)SIZE(-2)VALIDATE(DI
GIT," "):B :: IF B<2 OR B>LE
N(A$)THEN 20 :: CALL HCHAR(1
5,3,32,45)!140
30 ON WARNING NEXT :: ACCEPT
AT(13,9)SIZE(14)VALIDATE(DI
GIT," "):N :: IF N>B*10^12 T
HEN 30 !131
40 N=N/B :: A=N-INT(N):: N=I
NT(N):: B$=SEG$(A$,A*B+1,1)&
```

ARTIST FUNCTIONS

| SYMBOL | FUNCTION | TYPE | USE OF ENTER/FIRE | COMMENTS |
|--------|---------------------------|------|-------------------------|--|
| D | Draw | cmd | start/stop | hold fire down |
| P | Point | cmd | place | |
| L | Line | cmd | begin/end | |
| K | K-Line | cmd | begin/intermediate | D to exit |
| R | Rays | cmd | center/start/stop | D to exit |
| F | Fill | cmd | do | SPACE to abort |
| V | Frame | cmd | 1st corner, opp. corner | |
| X | Box | cmd | 1st corner, opp. corner | fills w/pattern |
| O | Circle | cmd | center/edge | |
| Q | Disk | cmd | center/edge | fills w/pattern |
| CTRL-A | Clear Image | cmd | | leaves color, pattern |
| H | Hor/Vert | cmd | begin/end | |
| N | Swap | cmd | new color/old color | pick new color, place on old color. negative image |
| I | Invert | mode | | does not use fonts, use CTRL x for width, FCTN x for height |
| E | AlphaNumeric | cmd | Begin lower left/stop | leaves pattern load/save/index picture |
| CTRL-B | Clear Color | cmd | | |
| S | Store | menu | | move with cursor cmds 4 reflections |
| Z | Zoom | mode | select window | |
| M | Mirror | mode | | |
| C | Hard Copy | menu | | |
| FCTN- | Plot/Erase | mode | | |
| FCTN- | Foregnd Color | cmd | change to next color | fast/slow toggle switch |
| FCTN- | Cursor Speed | mode | | color chosen will be fore- ground or background |
| F icon | Foreground/ Background | mode | | only "P" is solid use P to clean up borders |
| P icon | Pattern in use | mode | display next pattern | |
| - icon | Color Cursor | mode | | |

ENHANCEMENT FUNCTIONS

| | | | | |
|---|-----------------|--------|---|--|
| M | Move w/o Color | select | top left/bottom right/place | T to check |
| N | Move w/Color | select | top left/bottom right/place | T to check |
| C | Copy w/o Color | select | top left/bottom right/place | T to check |
| D | Copy w/Color | select | top left/bottom right/place | T to check |
| A | AlphaNumeric | menu | enter text/place text | SPACE to exit, T to check |
| S | Use a Slide | | select/place | SPACE to exit |
| | Slides | menu | | |
| | Define | | pick box/define slide | SPACE to exit |
| | Erase | | pick slide | SPACE to exit |
| | Rotate | | pick slide | SPACE to exit |
| | Load Slide file | | | __S added to filename |
| | Save Slide file | | | __S added to filename |
| | Load Instance | | enter name/place instance | T to check __I added to filename |
| | Save Instance | | enter name/select top lft/bot- tom right | __I added to filename |

SPACE BAR is used to toggle between the MENU screen and artwork. It can also be used to abort any function except ALPHA, STORE, SAVE/LOAD, or COPY.

Keyboard cursor movement: Horizontal/Vertical—S/E/D/X DIAGONAL—W/R/C/Z

```
B$ :: IF N>0 THEN 40 :: DISP
LAY AT(15,1):B$ :: B$="" ::
GOTO 20 !219
```

Micro Stuffer help

The following item is excerpted from the
(See Page 44)

User Notes

(Continued from Page 43)

newsletter of the K-Town 99ers, of Knoxville, Tennessee. It was written by Mike Epperson. According to Epperson, the Micro Stuffer printer buffer a friend purchased didn't work with the 4A.

After researching the TI RS232 manual and the Stuffer manual I felt possibly there was a wiring problem between the units since there were more connections shown in the Stuffer manual than in the TI book. The TI manual showed a ground connected to pin 16 on the 36-pin Centronics connector on the printer end of the cable. The Stuffer manual showed ground on pins 16, 17 and 19 through 30 of the same plug.

I proceeded to hook all these grounds together by jumpering all the listed pins together. I then tried the buffer ... and it worked.

The Micro Stuffer parallel printer buffer is available from Tenex and is compatible with most computer brands.

Cataloger outputs listings to labels

Disklabel is an Extended BASIC program by Robert Neal of the TI Users of Will County, of Romeoville, Illinois. The program outputs a disk catalog in compressed subscript to a standard 3 1/2 x 7/8 address label. The labels include disk information (sectors used and remaining as well as diskname) and three columns listing up to eight programs and files each per label.

Line 230 is used to set the linefeed depth between each line and line 500 is used to set the amount of space between labels for disks that need more than one label to contain their catalogs.

For lengthy catalogs, it may be just as well to output the catalog to paper and then tape the listing to the disk jacket. It takes up less space than affixing several labels to the disk jacket. Line 490 controls the number of lines that will be printed to a label. Change LC9 to a number large enough to handle a lengthy catalog. LC21, for example, would output 20 lines of three entries each.

Line 260 isn't necessary, since it only displays dummy data to the screen.

Printer codes may have to be modified to suit non-Epson control codes. The pro-

gram should be adaptable to any printer capable of printing subscript. Obviously, line 220 defaults to a parallel printer. Change this line for serial printers.

As a reminder, the numbers that appear after the exclamation point at the end of each program line are checksums. Do not include the exclamation point or the number while entering this program.

```

100 !***** !119
110 !*   DISKLABEL   * !066
120 !* by ROBERT NEAL * !032
130 !* T. I. USERS OF * !151
140 !* WILL COUNTY  * !177
150 !*ADAPTED TO EPSON* !050
160 !*   PRINTERS   * !078
170 !* by TOM ARNOLD * !002
180 !*CHANNEL 99 USERS* !020
190 !***** !119
200 DIM FN$(127),SZ$(127),PT
$(127)!193
210 TYPE$(1)="D/F" :: TYPE$(
2)= "D/V" :: TYPE$(3)="I/F" :
: TYPE$(4)="I/V" :: TYPE$(5)
="FGM" !173
220 OPEN #1:"PIO" !253
230 PRINT #1:CHR$(27)&CHR$(6
5)&CHR$(3);: !*** SETS LINE
FEED TO 6/72 INCH*** !104
240 PRINT #1:CHR$(15);!*** P
UTS PRINTER INTO CONDENSED P
RINT !218
250 DISPLAY AT(2,1)ERASE ALL
:"   DISKLABEL": "
=====": "   by Bob
Neal": "   Version 2.0":
:RPT$("- ",28)!000
260 DISPLAY AT(9,1):"Avail=2
91 Used =67  DISKNAME":RPT$(
"=",28):"DLABEL 20 PGM DLABE
L 27 PGM": "LOAD 15 PGM LD
ATA 25 D/F":RPT$("- ",28)!1
88
270 DISPLAY AT(20,1)BEEP:"PL
ACE DISK TO BE LABELED IN DR
IVE #1, THEN PRESS ANY KEY"
:: ST=1 !124
280 CALL KEY(0,K,ST):: IF ST
=0 THEN 280 !005
290 OPEN #2:"DSK1.",INPUT ,R
ELATIVE,INTERNAL !237
300 FOR X=1 TO CNT !050
310 FN$(X)="" :: SZ$(X)="" :
: PT$(X)="" !061
320 NEXT X !238
330 CNT=0 !156

```

```

340 INPUT #2:A$,J,J,K !156
350 IMAGE "##### ### ##
## ###          #####
###" !244
360 PRINT #1,USING 350:"AVAI
L=",STR$(K),"USED=",STR$(J-K
),CHR$(14)&A$ !078
370 PRINT #1:CHR$(27)&CHR$(8
3)&CHR$(1);: PRINT #1:RPT$(
"=",58)!158
380 LC=2 !072
390 FOR X=1 TO 127 !178
400 INPUT #2:A1$,A,J,K !196
410 IF LEN(A1$)=0 THEN 460 !
089
420 FN$(X)=A1$ :: SZ$(X)=STR
$(J):: SZ$(X)=RPT$(" ",3-LEN
(SZ$(X)))&SZ$(X)!230
430 A=ABS(A):: PT$(X)=TYPE$(
A):: IF A=4 AND K=254 THEN P
T$(X)=TYPE$(5)!081
440 CNT=CNT+1 !067
450 NEXT X !238
460 CLOSE #2 !152
470 FOR X=1 TO CNT STEP 3 !2
24
480 IMAGE ##### ### ##
##### ### ## #####
### ## ## !117
490 IF LC>9 THEN 500 ELSE 53
0 !161
500 PRINT #1:"":":":":":":":
!255
510 IMAGE "
#####
###" !187
520 LC=2 :: PRINT #1,USING 5
10:CHR$(14)&A$ :: PRINT #1:C
HR$(27)&CHR$(83)&CHR$(1);:
PRINT #1:RPT$("=",58)!041
530 PRINT #1:CHR$(27)&CHR$(8
3)&CHR$(1)!***PUTS PRINTER I
N SUBSCRIPT MODE*** !205
540 PRINT #1,USING 480:FN$(X
),SZ$(X),PT$(X),FN$(X+1),SZ$(
X+1),PT$(X+1),FN$(X+2),SZ$(
X+2),PT$(X+2):: LC=LC+1 !166
550 NEXT X !238
560 FOR X=1 TO 11-LC :: PRIN
T #1:"" :: NEXT X :: PRINT #
1:CHR$(27)&CHR$(84)!***LAST
PART RESETS SUBSCRIPT, MAY N
OT BE NEEDED ON GEMINI*** !0
97
570 DISPLAY AT(20,1)BEEP:"CA

```

(See Page 45)

User Notes

(Continued from Page 44)

```
TALOG ANOTHER? (Y/N) "": """: ""
!002
580 CALL KEY(3,K,S):: IF S=0
  THEN 580 !141
590 IF CHR$(K)="Y" THEN 270
ELSE IF CHR$(K)="N" THEN 600
  ELSE 570 !057
600 CLOSE #1 :: END !164
```

XBASIC program works on D/V80 files

Tom Wynne, of the Puget Sound 99ers, has developed a program called Pre-Formatter that may be of use to those who want to do global changes on TI-Writer files without using TI-Writer.

As it is listed here, the program will place carriage returns at the end of each line. It also gives the user the option of replacing all spaces with required space as symbolized by the caret. Users may easily modify this later option to permit search and replace of any character by changing line 200. In line 200, C1\$ represents the character to be changed and C2\$ represents the character you want to replace it with.

"I created it for the use of entering program listings and fixed format files in a document for use with the Formatter of TI-Writer," he wrote in his user group newsletter.

When the program is run, the user is prompted for the filename and drive designation of the file to be modified. If carriage returns already exist on the file, additional carriage returns will not be added.

The user should be able to modify the carriage return replacement operation as well by changing lines 360 and 370. The carriage return is identified by CHR\$(13).

Wynne warns that large files will result in a "memory full" error message.

```
!000 ! ***** !
235
110 ! * PRE-FORMATTER * !
095
120 ! * PUTS CRs AT END * !
```

| AVAIL= 148 | | USED= 210 | | MICROPEN | | | |
|------------|--------|------------|--------|------------|--------|--|--|
| CALC2 | 21 D/V | CALC3 | 22 D/V | CALC4 | 20 D/V | | |
| CALC5 | 18 D/V | DECI-CONV3 | 3 D/V | DECI-CONV4 | 3 D/V | | |
| DECI-CONV5 | 3 D/V | EPSN/PROW2 | 5 D/V | EPSN/PROW3 | 5 D/V | | |
| EPSN/PROW4 | 5 D/V | EPSN/PROWR | 5 D/V | PRNTAGPRO | 4 D/V | | |
| PRNTAGPRO2 | 4 D/V | PRNTAGPRO3 | 5 D/V | PRNTAGPRO4 | 5 D/V | | |
| PRNTP | 4 D/V | PRNTP2 | 4 D/V | PRNTP3 | 5 D/V | | |
| PRNTP4 | 5 D/V | PRTAGAX | 7 PGM | PRTAGAX2 | 6 D/V | | |
| PRTAGAX5 | 9 D/V | TEST1 | 10 PGM | TEST2 | 10 PGM | | |

```
119
130 ! * OF EACH LINE AND * !
056
140 ! * REPLACES SPACES * !
133
150 ! * WITH REQUIRED * !
084
160 ! * SPACE. " " * !
150
170 ! * BY TOM WYNNE * !
019
180 ! ***** !
235
190 DIM A$(300) !186
200 C1$=" " :: C2$="^" !061
210 PRINT "ENTER FILE NAME: "
  !172
220 ACCEPT BEEP:FN$ !255
230 PRINT "REPLACE ";C1$;"
  WITH ";C2$;" "?" ;!044
240 ACCEPT VALIDATE("YN"):YN
  $ :: IF YN$="" THEN 240 !190
250 OPEN #1:FN$,INPUT !072
260 I=0 !000
270 PRINT "READING FILE..."
  !054
280 IF EOF(1)THEN 320 !111
290 LINPUT #1:B$ !188
300 IF YN$="Y" THEN CALL REP
  LACE(B$,C1$,C2$) !176
310 A$(I)=B$ :: I=I+1 :: GOT
  O 280 !182
320 CLOSE #1 !151
330 PRINT "WRITING FILE..."
  !096
340 OPEN #1:FN$,OUTPUT !173
350 FOR J=0 TO I-1 :: IF A$(
  J)="" THEN 370 !214
360 IF SEG$(A$(J),LEN(A$(J))
  ,1)=CHR$(13)THEN 380 !200
370 A$(J)=A$(J)&CHR$(13) !031
380 PRINT #1:A$(J):: NEXT J
  :: CLOSE #1 !223
390 PRINT "FINISHED." !228
400 GOTO 210 !033
410 SUB REPLACE(A$,C1$,C2$) !
  213
420 B$="" !235
```

```
430 FOR I=1 TO LEN(A$) !229
440 CH$=SEG$(A$,I,LEN(C1$)) !
  160
450 IF CH$=C1$ THEN CH$=C2$
  !063
460 B$=B$&CH$ :: NEXT I :: A
  $=B$ !093
470 SUBEND !168
```

Recycle ribbons

Don Weber, of the West-Jax 99ers (Jacksonville, Florida) suggests that old printer ribbons can be made nearly as good as new. Here is his recommendation for re-inking ribbons.

Basically, the job is done by drawing the ribbon across a stamp-pad that is normally used for rubber stamps by applying a small amount of pressure to your ribbon while holding against the pad. The ribbon will absorb the ink. By arranging a method of continuously moving the ribbon across the stamp-pad at low speed, the entire ribbon will be re-inked in short order.

The ribbons for my printer have a convenient drive shaft that will fit in the chuck of a slow-speed drill motor. You may have to mark the ends of the ribbon with White-Out to know when one cycle has been completed. Also, it may be necessary to make a couple of passes to fully re-ink the ribbon. Or, make one pass on the inside of the ribbon and the second on the outside.

Make those numbers stand out

Although this program won't eliminate inputting errors, it may be of some assistance when entering and verifying numbers and punctuation marks. The program runs out of Extended BASIC and requires a memory expansion. It turns all numerals and punctuation white to highlight them as you enter or list a program. It's particularly useful when enter-

(See Page 46)

User Notes

(Continued from Page 45)

ing lengthy CALL CHAR codes. Once executed, the program remains in effect until the computer is turned off until CALL LOAD(-31804,0) is executed or the computer is reset. Simply enter the program and type RUN to activate it. The program appeared in the newsletter of the Twin Tiers User Group, of Horseheads, New York.

10 REM Turns all numeral and

punctuation white. By HARRY WILHELM !146

20 REM Turn on by CALL LOAD(-31804,63) Turn off by CALL LOAD(-31804,0) !095

50 CALL INIT !157

60 CALL LOAD(16128,2,224,38,0,2,0,8,17,2,1,63,36,2,2,0,3,4,32,32,36,2,224,131,192,3,128)!001

70 CALL LOAD(16164,240,240,240)!001

80 CALL LOAD(-31804,63)!107

User Notes is a column of tips and ideas designed to help readers put their computers to better use. The information provided here comes from many sources, including TI user group newsletters. MICROpendium pays \$10 for any item sent in by readers that appears in this column. Mail User Notes to MICROpendium User Notes, P.O. Box 1343, Round Rock, TX 78680.

User Supported Software

(Continued from Page 40)

that is not supported by commercially available graphics programs. The author asks \$5 for each of the disks (one contains the graphics, the other information and programs demonstrating how graphics are developed and printed). Include the type of printer you have. Copies of the printer's graphic commands table and the 8-pin bit value calculation would be helpful. Shugert will supply the media, mailer and postage. Some of the graphics are designed to work with cassette but are much slower than outputting from a diskette. Contact Shugert for more information about

the cassette graphics applications.

EDITOR FOR TI-RUNNER

Michael Rittweger, Nissenstrasse 12, D-2300 Kiel 14, West Germany, is offering an Editor for TI-Runner screens. The program, which runs out of XBASIC, allows the user to modify or create screens for TI-Runner. The program requires XBASIC, disk system and memory expansion. An Epson-compatible printer is optional. Documentation is on disk. For two disks, send \$15. The program and documentation are in German.

QUICK-LOAD

Robert Amenta, 14 Greene Rd., Hillcrest, NY

10977, is offering QUICK-LOAD. It consists of three programs: LOAD, QUICK-LOAD and README (documentation). Quick-Load works by creating a D/V80 file of all RUNnable program names (called CAT) on a diskette. When Load is run, it reads the file called CAT, which was created by Quick-Load. After the directory of RUNnable programs appears on screen, the cursor is used to select the program to LOAD. The README file is in the form of a program that allows the docs to be dumped to a printer or displayed on screen. The author asks for \$5 from those who use the program. D,PRM.

BBS upgraded

The 99 BBS in Whittier, California, has been upgraded by the addition of a Novation Pro 2400 baud modem. All functions are now operative at 2400 baud, according to sysop Roger Davis.

Other improvements include addition of support for the Geneve 9640 computer by Myarc, an enlarged help file, improvements to search functions in the message base and improved screen displays, he says.

The 24-hour board's number is (213) 947-7777. It operates at 300, 1200 and 2400 baud and is accessible by PC Pursuit.

Forth Text-to-Speech Demo

```
SCR #150
0 ( Text-To-Speech utility with the GRAM KRACKER - John Trundle )
1 BASE->R HEX 0 VARIABLE BUFR FD ALLOT
2 PARS @ 40 + VARIABLE NB
3 PARS @ 30 +
4 BUFR 1900
5 FILE SPEAKER
6 SPEAKER
7 SET-PAB DSPLY SONTL VRBL OUTPT FF REC-LEN
8 F-D" SPEECH" 0 PAB-ADDR @ VSBW
9 : TALKER 0 837C C! 0 83D0 ! 0 8354 ! 6 8355 C!
10 PAR-ADDR @ A + 834A 6 VMBR 8 836D C!
11 NB @ 8356 ! 3D GPLLNK ;
12 TALKER
13 : SAY BUFR 1A EXPECT
14 BUFR 1900 1A VMBW 1A CHAR-CNT!
15 3 PAR ADDR @ VSBW TALKER ;
```

R->BASE

Classified

Software

GENEVE JUMPBOOT

Boot 9640 MDOS in 4-7 seconds with this specially formatted disk. Free up RAM Disk for other programs. Developers dream — \$15.95 + \$2.00 S/H. Specify SD/DD. DISK ONLY SOFTWARE — See order info, this listing. v5n2

DISK ONLY SOFTWARE

Space Station PHETA — Explore an abandoned space station. A challenging game of skill — \$12.95 + \$2.00 S/H — P.O. Box 244, Lorton, VA 22079 — 1-800-456-9272. Visa, MC, AMEX accepted. v5n2

GENIAL COMPUTERWARE

PC Transfer, \$25.00 — Remind Me, \$15.00 — Graphics Expander, \$10.00 — XB:Bug, \$15.00 — XBasher, \$10.00 — GRAM Packer, \$10.00 — Horizon RAM Disk EPROM, \$25.00 (limited quantities) — Add \$2.00 S/H. DISK ONLY SOFTWARE — See order info, this listing. v5n2

Classified

Software

99 FORTRAN

You've heard about it. Now it's available! By Fortran expert Al Beard. Extensive Manual, Disks. — \$48.00 + \$3.00 S/H — DISK ONLY SOFTWARE — See order infor, this listing. v5n2

Introducing ROLL CREDITS

Now a special price and a free program with your order. Video "movie" makers, give that special touch to your productions. Create professional titles with the Roll Credits title generator. Only \$8 for cassette or \$10.95 for diskette. Send SASE for details or check with your order to: Newcastle Enterprises, P.O. Box 31881-MPO388, Phoenix, AZ. 85046. v5n2

TI-99/4a SOFTWARE

We're your direct source for TI Artist, Artist's Companion, CSGD, plus more!!! All new TI Artist enhancement software now available. Free catalog. Texaments, 53 Center Street, Patchogue, NY 11772. Call (516) 475-3480 or BBS (516) 475-6464. v5n3

CHECKBOOK RECONCILE \$29.95

Balance to the penny every month. Rocketman Checkbook Program. See our program review in August 1987 MICROpendium. California Programs, 4426 Appian Way, El Sobrante, Ca. 94803. 415-222-1626. v5n3

CREATIVE FILING SYSTEM v 7.0

"The most versatile data management system available for the TI99/4A!" This power packed system is extremely easy to operate and totally crash proof. Create up to 1000 records per file, graph numeric data, print mailing labels, print professional reports, create business forms and memos in ANY format plus a whole lot more! The CFS also supports mathematical operations. Requires 32K, Ext. BASIC, 1-3 disk drives and printer. Send \$15.00 to:

MARK BECK
8 FORRESTRIDGE CIRCLE
VALDOSTA, GA 31602 v5n2

Policy

The cost of classified advertising is 25 cents per word. Classified display (i.e., special formatting or graphics) is \$9 per column inch. Classified advertisements must be paid in advance. Classified advertisers may request a category under which they would like their advertisement to appear, but the final placement decision is the responsibility of the publisher.

Classified deadlines will be kept open for as long as practical. For the purpose of classified advertising deadlines, any classified ad received later than the first day of any month cannot be assured of placement in the next edition. We will do our best to include every advertisement that is submitted in the earliest possible edition.

The publisher offers no guarantee that any advertisement will be published in any particular issue. Any damages that result either from errors in copy or for failure to be included in any particular edition will be limited to the amount of the cost of the advertisement itself. The publisher reserves the right to reject any advertisement.

The advertiser may elect to publish the advertisement in subsequent editions at the same charge, payable prior to publication. The deadline for carryover classifieds is the same as for new advertising.

In submitting an ad, please indicate whether you would like a refund if it is not published in the requested edition or whether you would like us to hold it for the next edition. Cancellations and refunds cannot be made after the second day of the month.

Send classified advertising to: MICROpendium, P.O. Box 1343, Round Rock, TX 78680.

Software

PRINTER AIDS!!!

Learn how to control your printer. Printer control books & software available for: STAR NX-10; STAR NP-10; LEGEND 880; FASTEXT 80; GEMINI 10X; SMITH CORONA D-200; PANASONIC KX-P1091; OKIDATA; EPSON COMPATIBLES. Latest releases: "FAST AND EASY TUTOR FOR STAR NX-10" — \$14.95; "FAST AND EASY TUTOR FOR GEMINI 10X" — \$19.95; "FAST AND EASY TUTOR FOR LEGEND 880" — \$19.95; ALL COME WITH EASY TO READ BOOKLET AND INTERACTIVE DISK. For a complete catalog, send \$2 to McWARE, Dept TIM, POB 2784, Fairfax, VA 22031. v5n2

DATA X BLOW-OUT SALE

For a limited time, The BRAIN (see great review in August 1987 MICROpendium) and TI 1-2-3 word processor, spreadsheet, and typewriter integrated package, are available for \$9 each, or both for \$15. Regular price for The BRAIN is \$29.95, and for TI 1-2-3 is \$34.95. Don't miss this sale! Send payment to: **DATA X, 470 12th Ave North, St. Petersburg, FL 33701. Tel: 813-894-7472.** v5n3

Systems

TI99/4A System

Console, PEBox, Controller, RS232, 32K, two disk drives, cables, color

Systems

monitor, modem, tape recorder, all manuals, personal and business software. Best offer. Jim McIver, 6370 Windharp Way, Columbia, MD 21045 (H)301-381-1380; (O)202-879-6284. v5n2

TI99/4A SYSTEM — GOOD CONDITION

Console, P.E. box (32K, RS232), cartridges & loads of F.D. programs, modem & T.E. module, printer & all cables, manuals & literature. The "Source" literature & down-loads disks.....Business software — G.L., A.P., AR., Inv. Mailing, asking \$650.00. Also, MBX Box & Voice Reg. modules ..\$60.00. Call Doug — CT. after 6:00 p.m...203-673-3957, make a reasonable offer for all!!!!!!!!!!!!!! v5n2

Miscellaneous

| | |
|---|-------|
| 99/4A P-CODE CARD WITH ALL ORIGINAL DISKS AND MANUALS | \$155 |
| P-CODE CARD ALONE | \$ 90 |
| PE-BOX/RS232/32K/DRIVE/CONTR | \$349 |
| P-BOX EXTENSION CABLE | \$ 22 |
| PARALLEL PRINTER CABLE | \$ 15 |
| TI MULTIPLAN (NEW) | \$ 19 |
| STAND-ALONE DISK DRIVE (NEW) | \$ 89 |
| TI ORIGINAL 32K MEMORY CARD | \$ 89 |
| TI ORIGINAL COLOR MONITOR | \$199 |
| HAYES COMPATIBLE MODEM CABLE | \$ 12 |
| TE II | \$ 15 |

FREE SHIPPING

CALL OR WRITE

JIM LESHER
 722 HUNTLEY
 DALLAS, TX. 75214
 214 821 9274

v5.n2

The LEADING monthly devoted to the T199/4A

Subscription Fees

\$20 for 12 issues via domestic second class mail
\$25.25 (U.S. funds) Canadian or Mexican delivery
\$23.50 (U.S. funds) for 12 issues foreign delivery via surface mail
\$37.00 (U.S. funds) for 12 issues foreign delivery via air mail

Outside U.S., pay via postal or international money order; personal checks from non-U.S. banks will be returned

Tell us about it

Please let us what columns or features you like the most about MICROpendium. Rank your selections in order of preference using this form. Return it to us when you renew your subscription.

1. _____
2. _____
3. _____
4. _____

Other suggestions: _____

Address Changes

Subscribers who move may have the delivery of their most recent issue(s) delayed unless MICROpendium is notified six weeks in advance of address changes. Please include your old address as it appears on your mailing label when making an address change.

Back Issue Policy

Back issues of MICROpendium are available to subscribers only. Those wishing back issues may notify us of the issue(s) desired and include \$2.00 per issue desired in a check or money order. No shipping charge in U.S., Canada and Mexico; Texas residents add 7.5% sales tax. For foreign delivery, add 50 cents per issue surface mail, \$2 per issue surface mail. No discounts on orders of sets. All prices U.S. funds. **OUT OF STOCK: Vol 1, nos. 1-2**

Send me the next 12 issues of MICROpendium. I am enclosing \$ _____ in a check or money order in U.S. funds. Mail to: MICROpendium, P.O. Box 1343, Round Rock, TX 78680

Name _____

Address _____

City _____

State _____ ZIP _____

The set of numbers on the left of your mailing label indicates the cover date of your last issue.

v5.n2