

Covering the TI99/4A, the Myarc 9640 and compatibles

MICROpendium

Volume 5 Number 1

February 1988

\$2.00

Nut-z

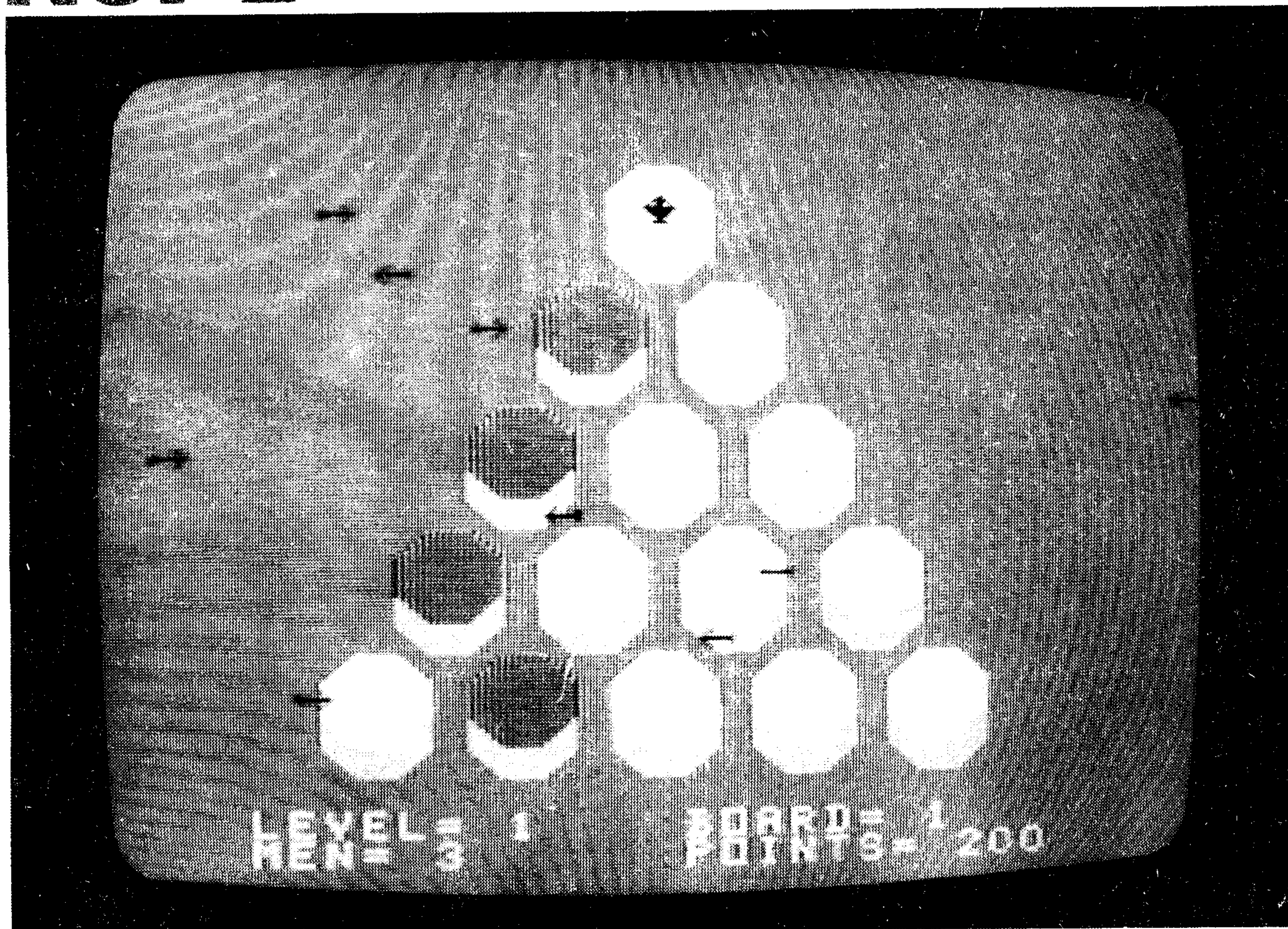

INSIDE

- What do TI users want? Survey provides clues.
- New owner of Horizon talks about RAMdisks.
- Myarc to protect some Geneve software.
- Regena offers help to trigonometry students.

The BIGGEST TI-99/4A SOFTWARE OFFER EVER

TEX+COMP™
TI USERS SUPPLY

PRESENTS:

TEXAS INSTRUMENTS & **TEX+COMP**
Announce
DRASTIC PRICE REDUCTIONS ON TEXAS INSTRUMENTS COMPUTER SOFTWARE

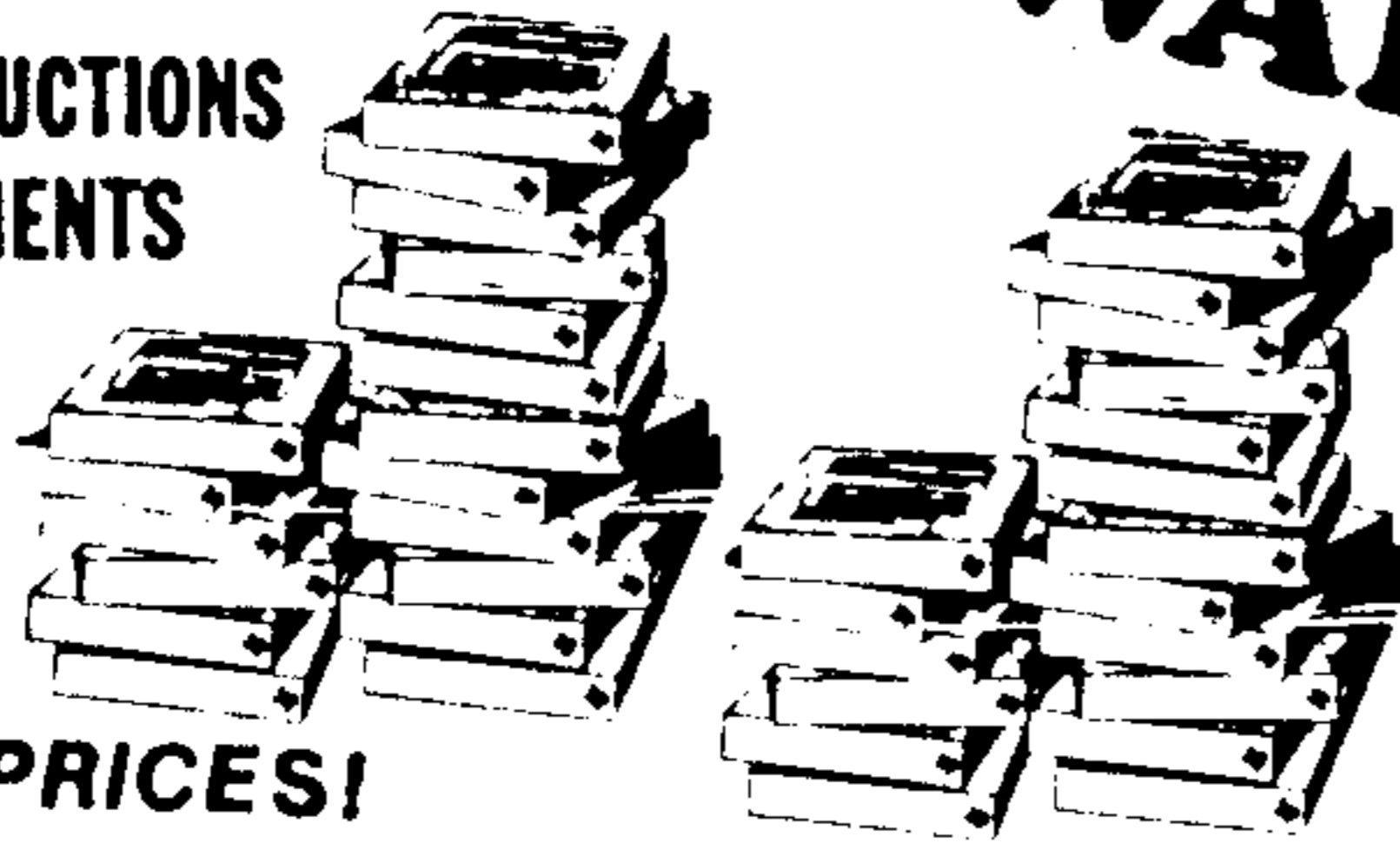

DISKETTE PROGRAMS NEW LOW PRICES!

- PHD 5026 Bridge Bidding I.....4.95
- PHD 5039 Bridge Bidding II.....4.95
- PHD 5041 Bridge Bidding III.....4.95
- PHD 5020 Music Maker Demo (use with module).....4.95

CASSETTE PROGRAMS

- see disk versions for req. i.e. TE-II
- PHT 6009 Music Skills Trainer.....4.95
 - PHT 6011 Computer Music Box.....4.95
 - PHT 6018 Market Simulation.....4.95
 - PHT 6031 Speak & Math.....4.95
 - PHT 6042 Spell Writer.....4.95
 - PHT 6026 Bridge Bidding I.....4.95
 - PHT 6039 Bridge Bidding II.....4.95
 - PHT 6041 Bridge Bidding III.....4.95
 - PHT 6020 Music Maker Demo (use with module).....4.95

TI-COUNT SMALL BUSINESS SOFTWARE

- General Ledger
- Accounts Receivable
- Accounts Payable
- Inventory
- Payroll
- Mail System

SPECIAL 1988 OFFER--ALL SIX PROGRAMS PLUS
AUTO COUNT AUTO EXPENSE
RECORD PROGRAM..... \$99.95
A \$250.00 SAVINGS !!!!!



MANAGEMENT AND SMALL BUSINESS

MODULES

- PHM 3006 Home Financial Decisions.....4.95
- PHM 3007 Household Budget Management.....4.95
- PHM 3022 Personal Real Estate.....4.95
- PHM 3016 Tax/Investment Rec. Keeping (disk req.).....4.95
- PHM 3035 Terminal Emulator II.....9.95
- PHM 3044 Personal Report Generator (PRK req.).....10.95
- PHM 3113 Multiplan.....24.95
- PHM 3112 TI Writer.....29.95

DISKETTE PROGRAMS NEW LOW PRICE!

- PHD 5001 Mailing List (upgraded version).....4.95
- PHD 5003 Personal Financial Aids.....4.95
- PHD 5021 Checkbook Manager.....4.95
- PHD 5022 Finance Manager.....4.95
- PHD 5024 Inventory Management.....4.95
- PHD 5027 Invoice Management.....4.95
- PHD 5029 Cash Management.....4.95
- PHD 5038 Lease/Purchase Decisions.....4.95
- PHD 5075 TI/Multiplan upgrade disk.....4.95

CASSETTE PROGRAMS

- PHT 6003 Personal Financial Aids.....4.95
- PHT 6038 Lease/Purchase Decisions.....4.95

MATH AND ENGINEERING

DISKETTE PROGRAMS NEW LOW PRICE!

- PHD 5006 Math Routine Library.....4.95
- PHD 5008 Electrical Engineering Library.....4.95
- PHD 5013 Graphing Package.....4.95
- PHD 5016 Structural Engineering Library.....4.95
- PHD 5044 AC Circuit Analysis.....4.95

CASSETTE PROGRAMS

- PHT 6006 Math Routine Library.....4.95
- PHT 6008 Electrical Engineering Library.....4.95
- PHT 6013 Graphing Package.....4.95
- PHT 6016 Structural Engineering Library.....4.95
- PHT 6044 AC Circuit Analysis.....4.95

****SPECIAL--ALL 5 OF THE ABOVE ON DISK OR TAPE---17.95

SPECIALS

Original TI Joysticks
\$7.95 (pair)

Replacement Console Power Supply (external transformer)
\$9.95

Replacement 99/4A Keyboards (plug in connection)
\$7.95

Cassette Cable
\$5.95
Console Dust Covers
\$7.95

PROTECT YOUR INVESTMENT WITH A BACK-UP TI99/4A

At only \$79.95 the Texas Instruments 99/4A home computer is still the wisest choice for any individual or family just starting out in computing. But for those of you who already own a 99/4A and have purchased hundreds or even thousands of dollars in peripherals and software, buying a back-up computer for under eighty dollars is the smartest and least expensive way to protect the investment in your system.

\$79.95*

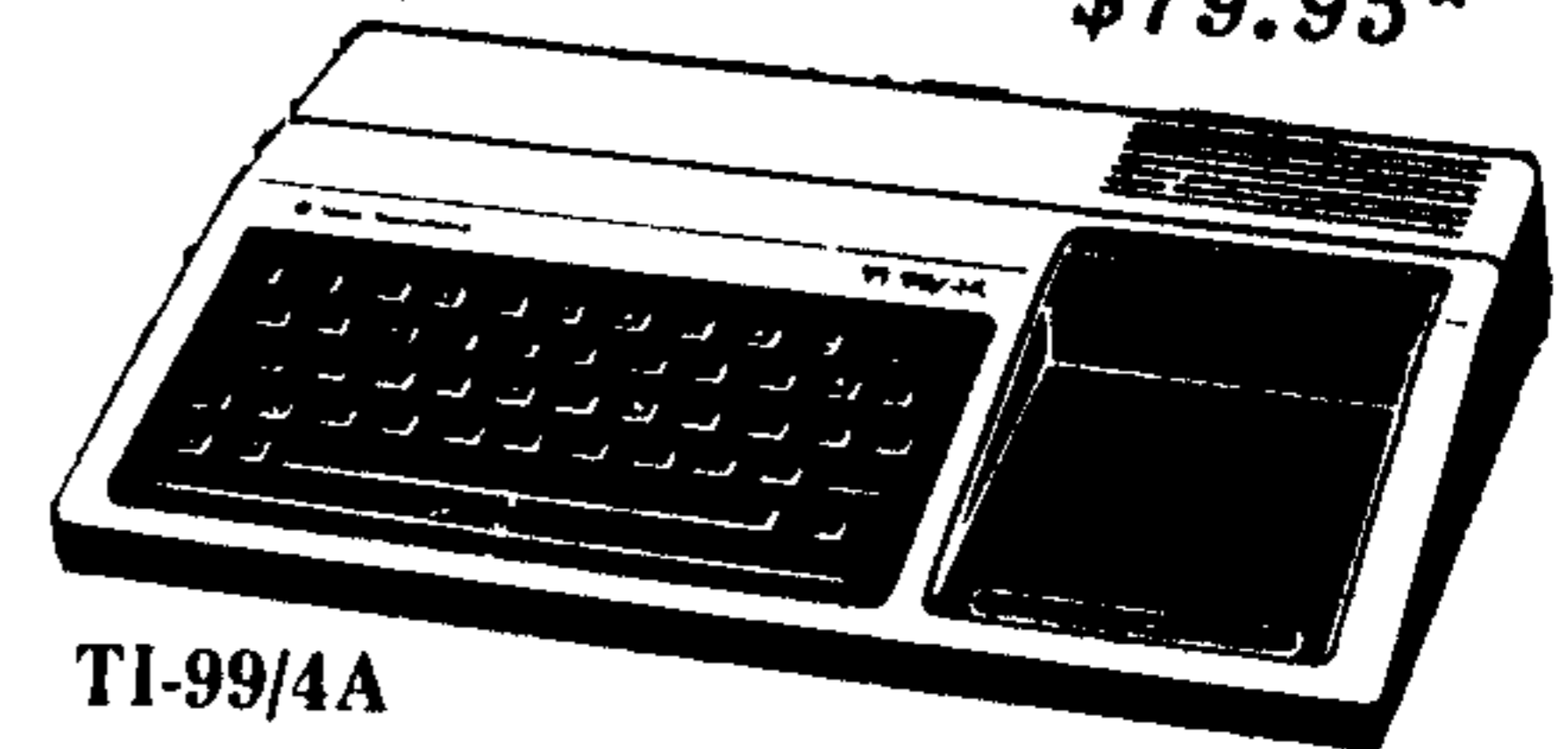

TI-99/4A

Are you using your 99/4A in the office and wish you had another to use at home? Is your family squabbling over who gets the computer first? You can put your back-up computer to use at once to solve these problems, and rest assured that your primary system is protected too.

Time is running out. The Texas Instruments home computer will not be available for sale much longer. Buy your back-up TI-99/4A now and protect your home computer system investment for the years to come.

*Shipping, handling & insurance on this special offer is \$10.00 (Continental U.S.) to any UPS deliverable address, HI, AK, Canada and APO slightly higher.

Send for **1988 Tex-Comp catalog & buyer's guide** only \$2.00 (comes with \$5 savings certificate)

Send order and make checks payable to:

TEX+COMP

P.O. BOX 33064 - GRANADA HILLS, CA 91344

TERMS: All prices FOB Los Angeles. For fastest service use cashiers check or money order. Add 3% shipping and handling (\$3.00 Minimum). East of Mississippi 4 1/2%. Add 3% for Credit Card orders. Prices and availability subject to change without notice. We reserve the right to limit quantities.



AUTHORIZED DEALER



VISA and MASTERCARD
HOLDERS CALL DIRECT
(818) 366-6631
24 Hour Order Line

NOTE: Payment in full must accompany all orders. Credit card, Company check or Money order for immediate shipment. Personal Checks require up to 4 weeks to clear. California orders add 6 1/2% sales tax.

1988 PRICES SLASHED

**NEW LOW PRICES ON
PERIPHERALS AND
SOFTWARE... OUR
LOWEST PRICES
EVER!!!!!!**

Tex-Comp
P.O. Box 33084, Granada Hills, CA 91344



**ORDER BY
PHONE**

Charge-It On Your
Visa or MasterCard

(818) 366-6631

24 HOURS a day-

Send for **1988** Tex-Comp catalog &
buyer's guide only \$2.00 (comes with \$5
savings certificate)

TI-99/4A Home Computer The System. The Software.

Better to start with. Better to stay with. Better to grow with.

Software

HOME ENTERTAINMENT

MODULES

PHM 3023	Hunt the Wumpus.....	4.95
PHM 3030	Amazing.....	4.95
PHM 3052	Tombstone City.....	4.95
PHM 3053	TI Invaders.....	4.95
PHM 3054	Car Wars.....	4.95
PHM 3057	Munch Man.....	4.95
PHM 3056	Alpiner.....	4.95
PHM 3112	Parsec.....	4.95
PHM 3031	The Attack.....	4.95
PHM 3032	Blasto.....	4.95
PHM 3194	Jawbreaker II.....	5.95
PHM 3110	Chisholm Trail.....	5.95
PHM 3034	Hustle.....	6.95
PHM 3037	Hangman.....	6.95
PHM 3025	Mind Challengers.....	8.95
PHM 3036	Zero Zap.....	8.95
PHM 3024	Indoor Soccer.....	8.95
PHM 3038	Connect Four.....	8.95
PHM 30420	Tunnels of Doom (with disk).....	9.95
PHM 3042T	Tunnels of Doom (with tape).....	9.95
PHM 3067	Othello.....	9.95
PHM 3149	Space Bandits.....	9.95
PHM 3220	Micro Surgeon.....	9.95
PHM 3219	Super Demon Attack.....	9.95
PHM 3224	Moonsweeper.....	9.95
PHM 3222	Fathom.....	9.95
PHM 3233	Burgertime.....	9.95
PHM 3131	Moonmine.....	9.95
PHM 3146	Munchmobile.....	11.95
PHM 3197	Slymoids.....	15.99
PHM 3225	Star Trek.....	15.95
PHM 3226	Buck Rogers.....	15.95
PHM 3227	Congo Bongo.....	15.95

DISKETTE PROGRAMS **NEW LOW PRICES!**

PHD 5002	TI-TREK (TE-II req. for speech).....	4.95
PHD 5010	Mystery Melody.....	4.95
PHD 5015...	Oldies But Goodies I.....	4.95
PHD 5017	Oldies But Goodies II.....	4.95
****SPECIAL	Oldies But Goodies I & II.....	7.95
PHD 5025	Sat. Night Bingo (Ex-Basic & Speech)....	4.95
PHD 5037	Draw Poker (Ex-Basic).....	4.95
CASSETTE PROGRAMS		
PHT 6002	TI-Trek (TE-II req. for speech).....	4.95
PHT 6010	Mystery Melody.....	4.95
PHT 6015	Oldies But Goodies I.....	4.95
PHT 6017	Oldies But Goodies II.....	4.95
****SPECIAL	Oldies But Goodies I & II.....	7.95
PHT 6026	Sat. Night Bingo (Ex-Basic & Speech)....	4.95
PHT 6037	Draw Poker (Ex-Basic).....	4.95

ADVENTURES

PHM 3041D	Adventure Module & Pirate Adv.(disk)....	6.95
PHM 3041T	Adventure Module & Pirate Adv.(tape)....	6.95
ADVENTURE SERIES (must be used with PHM 3041 module)		
specify disk or tape with order		
	Adventureland.....	4.95
	Mission Impossible.....	4.95
	Voodoo Castle.....	4.95
	The Count.....	4.95
	Strange Odyssey.....	4.95
	Mystery Fun House.....	4.95
	Pyramid of Doom.....	4.95
	Ghost Town.....	4.95
	Savage Island I&II (two adventures).....	4.95
	Golden Voyage.....	4.95
	Knight Ironheart Adventure.....	4.95
****SPECIAL-ALL ABOVE ADVENTURES ON DISK OR TAPE..		17.95
	Spiderman Adventure.....	7.95
	Incredible Hulk Adventure.....	7.95
	Buckaroo Banzai Adventure (based on the movie).....	7.95
	Sorcerer of Claymorgue Castle.....	7.95
****SPECIAL-ALL OF THE ABOVE FOUR + HINT BOOK + TWO NEW		
BONUS ADVENTURES.....		17.95
****SUPER ADVENTURE SPECIAL-BOTH OF THE ABOVE SPECIALS		
+COMPLETE HINT BOOK+ADVENTURE MODULE		29.95
PHM 3189	Return to Pirate's Island(self contained	
	adventure on module with graphics).....	11.95
MBX Programs (MBX Unit Required)		
PHM 3154	Terry Turtle's Adventure.....	2.95
PHM 3155	I'm Hiding.....	2.95

COMPUTER PROGRAMMING AIDS

MODULES

PHM 3999	Super Extended Basic.....	59.95
PHM 3026	Extended Basic.....	49.95
PHM 3058	Editor Assembler.....	19.95
PHM 3058	Mini Memory (with Writer I).....	38.95

DISKETTE PROGRAMS

PHD 5007	Teach Yourself 99/4A Basic.....	4.95
PHD 5019	Teach Yourself Extended Basic.....	4.95
PHD 5004	Programming Aids I.....	4.95
PHD 5005	Programming Aids II.....	4.95
PHD 5012	Programming Aids III.....	4.95
PHD 5077	Programming Aids I, II, III.....	9.95
PHD 5067	Beginning Basic Tutor.....	4.95
PHD 5076	Text to Speech (Ex Basic Speech).....	4.95
PHD 5098	TI Forth & manual (Ed/Assem req.).....	19.95
PHD 5078	TI Forth Demo Disk (Ed/Assem).....	4.95
PHD 5079	TI Forth Source Code (2 disks).....	7.95

CASSETTE PROGRAMS

PHT 6006	Programming Aids I.....	4.95
PHT 6007	Teach Yourself 99/4A Basic.....	4.95
PHT 6019	Teach Yourself Extended Basic.....	4.95
PHT 6067	Beginning Basic Tutor.....	4.95

EDUCATION

MODULES

PHM 3002	Early Learning Fun.....	4.95
PHM 3003	Beginning Grammar.....	4.95
PHM 3010	Physical Fitness.....	4.95
PHM 3010	Music Maker.....	9.95
PHM 3021	Weight Control & Nutrition... ..	10.95
PHM 3109	TI LOGO II (32K req.).....	19.95
PHM 3015	Early Reading (speech syn. req)	9.95
PHM 3043	Reading Fun.....	9.95
PHM 3046	Reading On.....	9.95
PHM 3047	Reading Roundup.....	9.95
PHM 3048	Reading Rally.....	9.95
PHM 3082	Reading Flight.....	9.95
PHM 3027	Addition & Subtraction I.....	9.95
PHM 3028	Addition & Subtraction II.....	9.95
PHM 3029	Multiplication I.....	9.95
PHM 3049	Division I.....	9.95
PHM 3050	Numeration I.....	9.95
PHM 3051	Numeration II.....	9.95
PHM 3060	Scholastic Spelling 4 (speech).....	9.95
PHM 3061	Scholastic Spelling 5 (speech).....	9.95
PHM 3062	Scholastic Spelling 6 (speech).....	9.95
PHM 3091	Milliken Subtraction.....	9.95
PHM 3092	Milliken Multiplication.....	9.95
PHM 3093	Milliken Division.....	9.95
PHM 3094	Milliken Integers.....	9.95
PHM 3098	Milliken Number Readiness... ..	4.95
PHM 3099	Milliken Laws of Arithmetic.. ..	4.95
PHM 3100	Milliken Equations.....	4.95
PHM 3101	Milliken Measurement of Formulas.....	4.95
PHM 3114	Alligator Mix.....	6.95
PHM 3115	Alien Addition.....	6.95
PHM 3119	Meteor Multiplication.....	6.95
PHM 3118	Minus Mission.....	6.95
PHM 3177	Face Maker.....	9.95
PHM 3178	Story Machine.....	9.95

DISKETTE PROGRAMS

PHD 5009	Music Skills Trainer.....	4.95
PHD 5011	Computer Music Box.....	4.95
PHD 5018	Market Simulation.....	4.95
PHD 5030	Speak & Spell II (Ex Basic req.).....	9.95
PHD 5031	Speak & Math (TE-II req.)....	4.95
PHD 5042	Spell Writer (TE-II req.)....	4.95

Contents

MICROpendium

MICROpendium is published 12 times annually for \$20 per year by Burns-Koloen Communications Inc., 16606 Terrace Dr., Austin, TX 78728. Application to Mail at Second-Class Postage Rates is Pending at Round Rock, Texas. POSTMASTER: Send address changes to MICROpendium, P.O. Box 1343, Round Rock, TX 78680.

No information published in the pages of MICROpendium may be used without permission of the publisher. Only computer user groups that have exchange agreements with MICROpendium may excerpt articles appearing in MICROpendium without prior approval.

While all efforts are directed at providing factual and true information in published articles, the publisher cannot accept responsibility for errors that appear in advertising or text appearing in MICROpendium. The inclusion of brand names in text does not constitute an endorsement of any product by the publisher. Statements published by MICROpendium which reflect erroneously on individuals, products or companies will be corrected upon contacting the publisher.

Unless the author specifies, letters will be treated as unconditionally assigned for publication, copyright purposes and use in any other publication or brochure and are subject to MICROpendium's unrestricted right to edit and comment.

Display advertising deadlines and rates are available upon request.

All correspondence should be mailed to MICROpendium at P.O. Box 1343, Round Rock, TX 78680. We cannot take responsibility for unsolicited manuscripts but will give consideration to anything sent to the above address. Manuscripts will be returned only if a self-addressed stamped envelope is included.

Foreign subscriptions are \$25.25 (Canada and Mexico); \$23.50, surface mail to other countries; \$37 airmail to other countries.

All editions of MICROpendium are mailed from the Round Rock (Texas) Post Office.

Mailing address: P.O. Box 1343, Round Rock TX 78680

Telephone: (512) 255-1512

Source: TI4596

CompuServe: 75156,3270

Delphi TI NET: MICROPENDIUM

John Koloen.....Publisher
 Laura Burns.....Editor



Table of Contents



Regena on BASIC

A program for trigonometry students.....Page 12

More on computer maintenance

Helping keep your computing trouble-free.....Page 18

Nut-Z

An XBASIC game that may drive you that way.....Page 22

Printing in multiple columns

Second in a two-part series, this installment includes information about using the program with the TIW Formatter.....Page 27

c99

Down the rabbit hole with cryptograms.....Page 28

A TI users survey

Results of a national poll.....Page 31

Horizon RAMdisk

An interview with Bud Mills, the new owner.....Page 33

Geneve 9640

Programming tools.....Page 35

Programming in MDOS.....Page 37

Myarc to protect some software.....Page 39

Reviews

Disk Utilities, V. 4.0.....Page 40

Newsbytes

More fairs coming up, a new address for the Dutch users group, and a newsletter for EZ-Keys users.....Page 42

User Notes

A calculator program, faking out the mini-expansion box and a letter envelope design program.....Page 43

Classified.....Page 47

Sensational Prices!!! ... On Our Most Popular Hardware and Software!!

TOP QUALITY PERIPHERALS from CorComp • Myarc

CORCOMP

Triple Tech. Board for PE Box includes clock/calendar, printer buffer, and speech synthesizer connection.

- 34643 \$138.00
 - 34639 Clock/Calendar. Stand-alone \$79.95
 - 34396 9900 32K Micro Memory. Stand-alone 32K. \$99.95
- The Memory Plus series
- 41070 256K Memory Plus Stand-Alone. \$219.00
 - 41633 512K Memory Plus Stand-Alone. \$279.00
 - 41051 256K Memory Plus Card. \$196.00
 - 41065 512K Memory Plus Card. \$253.00

See "Best Selling Hardware" for more CorComp products.

MYARC

- 34324 256K Card. \$179.00
- 42245 512K Card. \$239.00
- 38179 Extended BASIC Level IV. \$59.95
- 38395 256K Card with Extended BASIC Level IV. \$249.00
- 42231 512K Card with Extended BASIC Level IV. \$289.00
- 38198 512K Upgrade Kit for the 128K Card. \$109.95

See "Best Selling Hardware" for more Myarc products.

COMPUTER WAR

Based on the hit movie "War Games"...one of our best sellers. Can you crack the code and destroy the simulated enemy missile before the world is engulfed in a thermonuclear holocaust?

42480 TI CARTRIDGE.....\$24.95

MICROPENDIUM SPECIAL THE 39¢ DISKETTE!



Are you paying too much for diskettes? Try our first quality, prime, 5 1/4" diskettes (no rejects, no seconds) at these fantastic sale prices and save, save, SAVE! Disks are packaged in boxes of 50; each box contains 5 shrink-wrapped 10-packs that include diskettes in sleeves, labels, and write-protect tabs.

Each diskette is certified to be 100% error free and comes with a lifetime warranty (if you have a problem, we'll replace the diskette). All diskettes include hub reinforcement rings and write-protect notch.

32391 SS, DD Diskettes Box of 50
\$19.50
(39¢ each!)

32403 DS, DD Diskettes \$24.50
(49¢ each!)

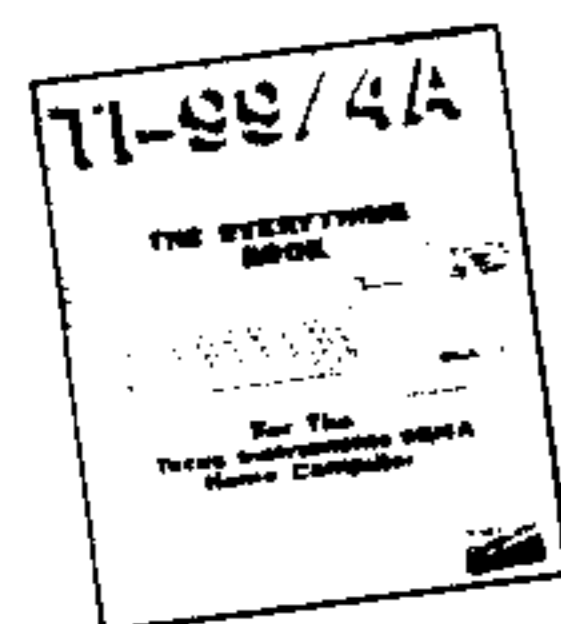

FREE!
"EVERYTHING BOOK"
For the
TI Home Computer
Order Item #25982



AVAILABLE FROM
YOUR FRIENDS AT

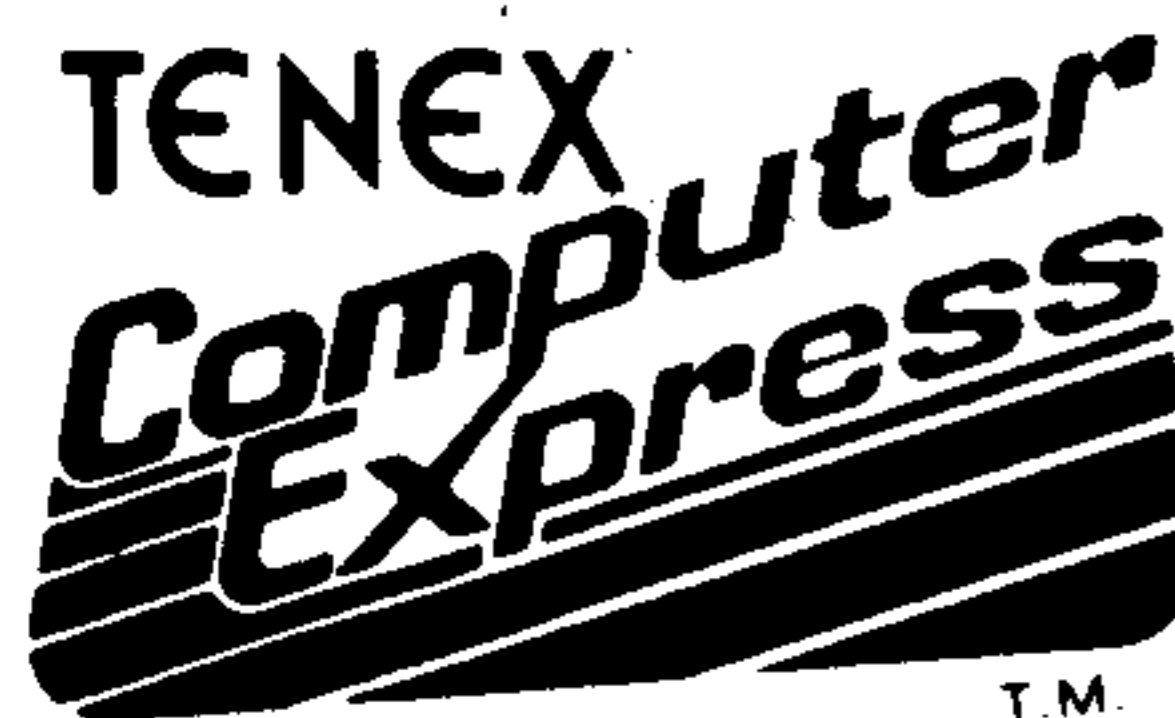

We gladly accept
mail orders!

P.O. Box 6578
South Bend, IN 46660

Questions? Call
219/259-7051

NOTE: Due to publishing lead-times, product prices and specifications are subject to change without notice

NEW
LOW
PRICE!



MicroPal® Extended BASIC

MicroPal's Extended BASIC package now includes two free software programs! Bestsellers **Typewriter** and **Name-It** from Extended Software are included in disk and cassette versions with complete manual — absolutely free!! You can immediately begin using the power of Extended BASIC for word processing and data



base functions. MicroPal Extended BASIC is unconditionally guaranteed to be 100% compatible with all programs written in TI Extended BASIC. With this powerful, high-level language, programmers can have automatic access to the 32K memory expansion, utilize sprite graphics for smooth motion and animation, auto-load disk based programs, and add speech with a 400 word built-in vocabulary! Package includes Extended BASIC on a convenient plug-in cartridge with 240 page manual. Sug. Retail \$89.95

32967

ONLY \$49.95!!

MYARC GENEVE COMPUTER



Here's the good news... the new Myarc Geneve Computer you've been hearing about is to be shipping by press time! Imagine a computer that is 99/4A compatible but has the speed and incredible graphics capabilities that even IBM, Amiga, and Atari ST owners would envy!

The Geneve is truly a breakthrough... since it's offered on a card, and is compatible with your existing Expansion Box, disk controller, and RS-232 cards, its advanced features can be offered at a cost much lower than you would expect to pay for a system of this power and versatility!

Features include standard or enhanced keyboard, 80 column display, 640K of RAM plus 128K VDP RAM, and conversion instructions.

\$Call Today for Lowest Price!\$

BEST-SELLING HARDWARE!

STAR MICRONICS PRINTER

75077 NX100 Rainbow Color Printer.....\$269.95



32986 MYARC RS-232 CARD \$ 99.95

13300 CORCOMP RS-232 CARD \$ 89.95

42250 PARALLEL PRINTER INTERFACE \$ 44.95

29784 CORCOMP RS-232 INTERFACE \$127.00

29802 CORCOMP 9900 MICRO-EXPANSION SYSTEM \$329.00

32972 MYARC DISK CONTROLLER CARD \$CALL

29770 CORCOMP DISK CONTROLLER CARD SALE! \$149.95

13315 CORCOMP 32K MEMORY CARD \$119.95

20164 BOX WITH POWER SUPPLY for external disk drive \$ 59.95

31173 WICO 3-WAY GATELOCK JOYSTICK \$ 24.95

10285 TI JOYSTICK ADAPTER \$ 4.95

42442 TAC 5™ JOYSTICK. Requires TI Adapter \$ 14.95

42086 SLIK STICK™ JOYSTICK. Requires TI Adapter \$ 6.95

13329 NAVARONE CARTRIDGE EXPANDER \$ 24.95



ORDER AMOUNT	CHARGE
less than \$20.00	\$3.75
\$20.00-\$39.99	4.75
\$40.00-\$74.99	5.75
\$75.00-\$149.99	6.75
\$150.00-\$299.99	7.75
\$300 & up	8.75

Foreign Orders add \$4.00;
heavy items ship at actual cost

NO EXTRA FEE FOR CHARGES



We verify charge card addresses

ORDER TOLL FREE
1-800-348-2778
INDIANA 1-800-225-6838



Comments

Survey sketches 'average' user

In an effort to learn more about TI99/4A users and how they use their machines, Ali Ulgen devoted a lot of time last year polling user groups and their members. We're publishing the results this month to give you an idea of what other TI users are doing. The biggest caveat on the poll is that virtually all respondents are members of user groups. Whether what they have to say is indicative of the attitudes of non-user group members is anybody's guess. But the tabulations are interesting.

DON'T BUY FROM ORDER 99

We alerted readers late last year to postpone purchases from Order 99, a company that had sold TI products. The owner, James Kaster, told us he had encountered medical difficulties and was trying to get back on track. We have since concluded that he has no intention of getting back on track. Anyone with an unfulfilled order from Order 99 may want to file a complaint with his local post office. We've sent him a certified letter which has been returned with the notice that he refuses to accept delivery. The most recent address we have for him is 3512 Sun Lake Dr., St. Charles, MO 63301.

FIXES FOR CARTRIDGES

Myarc has decided to provide software patches for cartridges that currently won't run on the Geneve. Patches for Video Chess have already been published in MICROpendium. We expect to publish patches for Plato and Logo II next month.

Meanwhile, if there are cartridges that you'd like to use but can't,

write us. Send us a list of the non-running cartridges that you'd like to see running on the Geneve. We will compile this information and Myarc will create patches for the top 20 requested cartridges. The patches will be published in MICROpendium.

Mail your lists to Patches, c/o MICROpendium, P.O. Box 1343, Round Rock, TX 78680.

IN FUTURE ISSUES

Things to look forward to in coming months include a comparison of the four major telecommunications networks as they relate to the TI99/4A. They are, of course, CompuServe, The Source, Delphi and Genie. We'll focus on what users think of the various services, including strengths and weaknesses, likes and dislikes.

Ready to go is an article by Dr. Eric Bray on how to connect a hard disk drive to the Myarc hard/floppy disk controller. We'll publish it as soon as the controller is released. Also available at this time is a pre-review of the promising Pasc 99, a Pascal system for the TI that doesn't require TI's p-code card. The article is by Stephen Shaw. Unfortunately, marketing decisions haven't been finalized, so publication will be delayed until the program is available to users.

And next month, benchmarks comparing the Geneve with a number of other personal computers, and an update of User-Supported Software.

—JK

Reviewed in MICROpendium

1984

February: B-1 Nuclear Bomber, Tandon TM-100 Disk Drive, Void, Beanstalk Adventure, Microsurgeon, On Gaming, Database 500.

March: Star Trek, Escape From Balthazar, Garkon's Getaway, Sky Diver, Mail-Call, Prowriter 8510 Printer.

April: Monthly Budget\$ Master, Budget Master, Home Budget, Thief, Donkey Kong, Khe Sanh.

May: Companion Word Processor, Q*Bert, Mad-Dog I & II, Programs for the TI Home Computer.

June: Creative Expressions Accounts Receivable/Accounts Payable, CDC 9409 Disk Drive, Starship Concord, Lost Treasure of the Aztec, ASW Tactics II.

July: Theon Raiders, Introduction to Assembly Language for the TI Home Computer, Game of Wit, Pole Position

August: TE-1200, Tower, Galactic Battle, Galaxy

September: Wycove Forth, 99/4 Auto Spell-Check, QUICKCOPYer, Wizard's Dominion, Anchor Automation Mk XII Modem

October: Killer Caterpillar, ZORK I, Defender

November: 9900 Disk Controller Card/Manager, Super Bugger, Transtar 120S printer, Floppy-Copy, Data Base-X

December: Gravity Master, Data Base Manager System, Learning 99/4A Assembly Language Programming

1985

January: Super Sketch, Foundation Computing 128K Card, PTERM-99, TI-Runner

February: Super Extended BASIC, Beginning Assem-

bly Language for the TI, ZORK II

March: Morning Star Software CP/M Card, WDS/100 Winchester Disk Drive, Sketch Mate, BMC Color Monitor

April: 9900 Micro Expansion System, Disk + Aid, Gemini 10X-15X

May: Character Sets and Graphics Design, Draw 'N Plot

June: GRAPHX, DATA BASE I

July: Acorn 99, Advanced Diagnostics

August: Model Dow-4 Gazelle, TI-Artist, PC-KEYS, Not-Polyoptics' Bankroll

September: Midnite Mason, Myarc 32K/128K Card, GRAPHX Companion

October: 4A/TALK, Extende BASIC II Plus, XB Detective, Console Writer 2.a

November: Foundation Z80A/80-column cards, 9900BASIC, Adventure Editor

December: Display Enhancement Package, Triple Tech

1986

January: BITMAC, Starcross

February: Night Mission, Peripheral Diagnostic Module, BA-Writer

March: Super Duper, Tunnels of Doom Editor, Business Graphs 99

April: U.S. Open Tennis, PRBASE

May: 4A Flyer, GRAM Kracker, Artist's Companion

June: Myarc Disk Controller Card, Maximem

July: Horizon RAMdisk, Old Dark Caves, Funlwriter, TI99/4A Macro Assembler

August: JOYPAINT 99, GPL Assembler, TI99/4A Intern, GPL Linker

September: Mechatronic 128K Card

October: TI-Forth Utilities, CorComp Memory Plus

November: Submarine Commander, PEP, MAX-RLE

December: GK Utility I and II and GRAM Packer, X-10 Powerhouse, RAVE 99/101.

1987

January: MG DISKASSEMBLER, Myarc XBII

February: TI-Tax, Mechatronic Mouse

March: Wycove Forth version 3.0, DIJIT Systems RGB Conversion Kit, Spad XIII Flight Simulator

April: Geneve 9640, Disk Utilities

May: QS-Solitaire, Geneve 9640 (Part 2), Technical Drive, Console Calc

June: Character Sets and Graphic Design III, Writerease Ver. 1.1, 4A DOS, Prescan_It

July: Junkman Junior, Avatex 1200/1200hc modem, Bubble Plane

August: Prostick, The Brain, Rocketman, Menu Ver. 6.3

September: TI-IBM Connection, Super Extended BASIC

October: Fontwriter, Mechatronic 80-column card, Star NP-10 printer

November: Legends, Music Preprocessor, QS-Wheel, Spin-to-Win

December: Remind Me, Certificate 99, My-Art and Myarc Mouse

1988

January: Quik Font, EZ-Keys

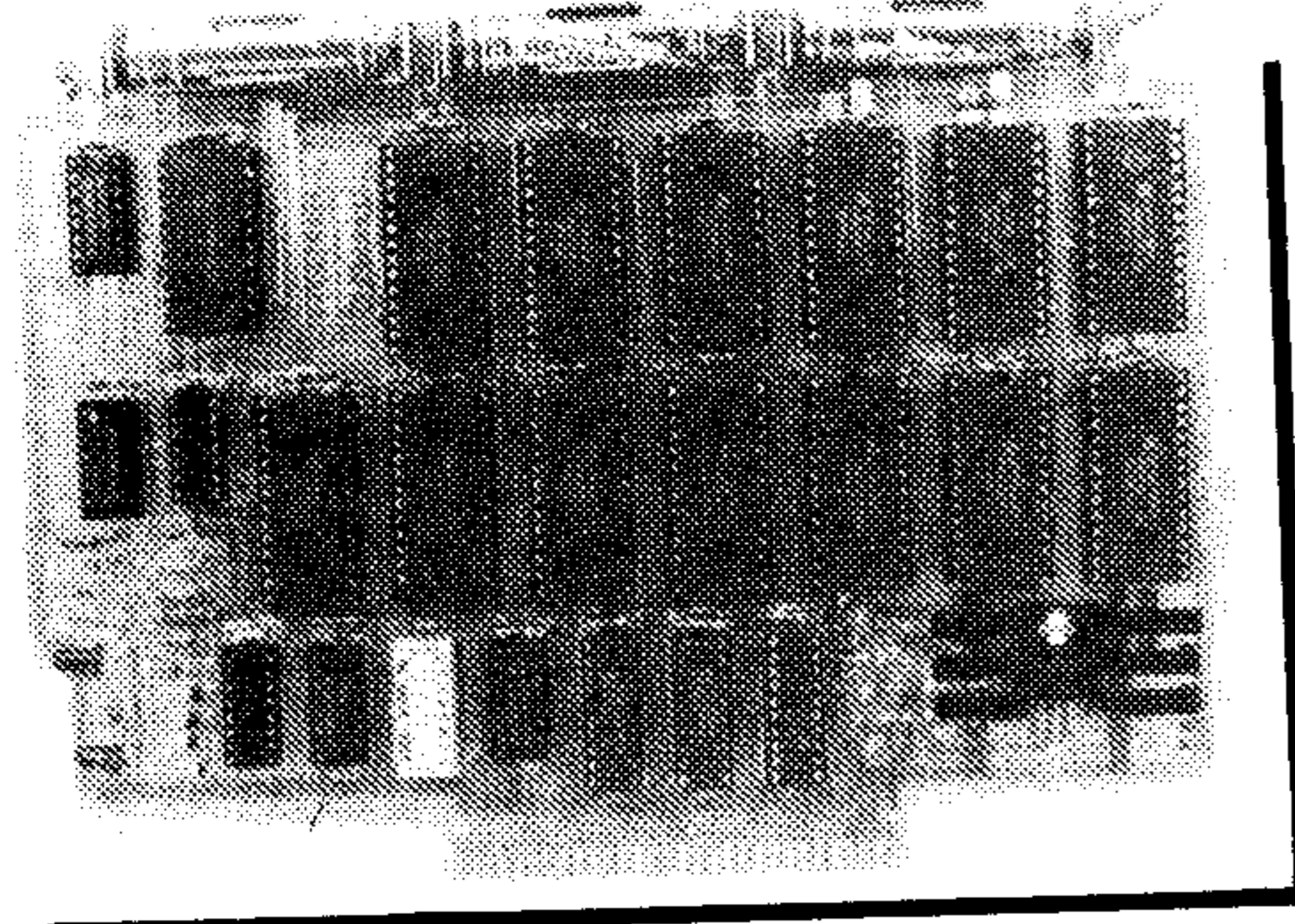

The

HORIZON RAMDISK

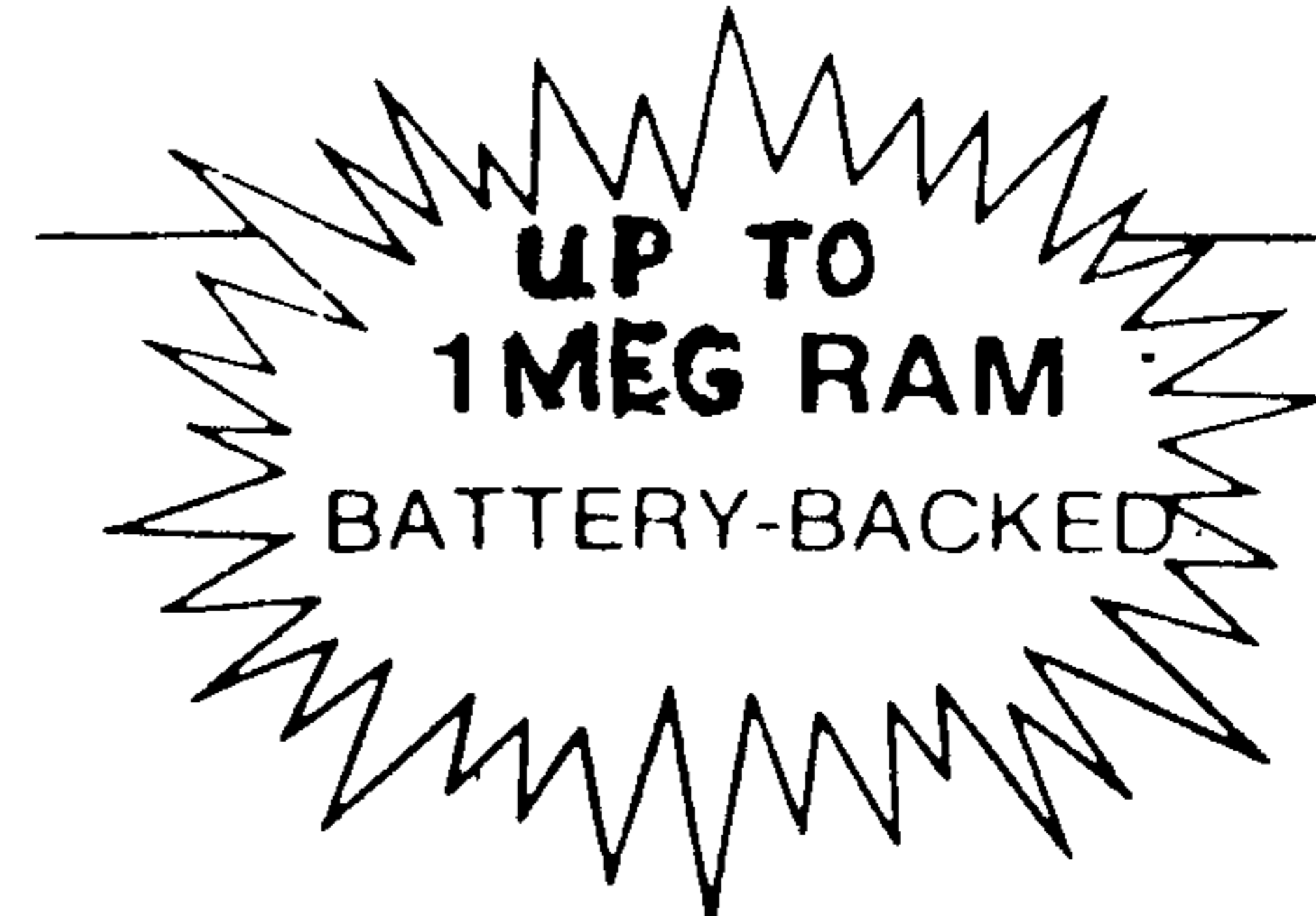

***\$45* PC BOARD with MANUAL and SOFTWARE**

***\$38* PC BOARD only**

HORIZON COMPUTER LIMITED has been purchased by BUD MILLS SERVICES. The bare Horizon Card may still be purchased as before, but your orders should be sent to:
 BUD MILLS SERVICES
 166 Dartmouth Drive
 Toledo Ohio 43614

ANNOUNCING THE HRD+ RAMDISK

This Ramdisk is constructed on the HORIZON Ramdisk Board using the Hitachi 62256LP12 (32K) CMOS Memory chips (or the equivalent NEC 43256LP12).

The Card is available NOW in several memory sizes- ONE+MEG, 800K (GENEVE), 512K, 384K (DSDD), 192K (DSSD), and 96K (SSSD). See attached Order Form for Prices.

The Operating System (Thanks to John Johnson and Mike Ballman of the Miami Users Group) allows the Ramdisk to be divided into TEN logical drives or less. Only two DSK (numbers) are used, the remaining drives will respond to DSK(name). The Menu program (Ver. 7.3) allows for 9 calls plus fifteen menu selections that you can edit on screen to customize the way you want it to appear - no more sector editing. XB programs can now be loaded from a call.

The HRD+ Kits include:
 The HORIZONS RAMDISK BOARD
 Assembly instructions
 Op System and MENU Software
 User Documentation
 and ALL required parts.

Note: This Menu Ver. 7.3 works on ANY Horizon Ramdisk and allows BOOTING the Geneve.

Call TI-COMM BBS on 419 385 7484 for current prices or information 300 Baud, 7bit, even / 1200, 8bit, no

To BUD MILLS SERVICES
 166 Dartmouth Dr.
 Toledo Ohio 43614 DATE _____

From name _____
 address _____
 city _____ state _____
 zip _____ phone (____) _____

Please "RUSH" my HRD+RAM kit(s)
 PRE-PAID by Check or Money Order

Quan	Type Kit	cost/ea	amt
+	HRD+RAM ONE MEG	\$435.00	
+	HRD+RAM 800k/GENEVE	\$375.00	
+	HRD+RAM 512k	\$265.00	
+	HRD+RAM 384k DSDD	\$225.00	
+	HRD+RAM 192k DSSD	\$165.00	
+	HRD+RAM 96k SSSD	\$140.00	

The above Kits include the HORIZON Card Instructions, MENU ROS and ALL parts

+	Bare HORIZON card	\$38.00	
+	MANUAL and SOFTWARE	\$ 7.00	
+	PHOENIX MOD to add a 90k BOOT Drive to 384 - 800k/GENEVE	\$60.00	
+	Cost to Build a Kit	\$60.00	

	Item total	\$
5% discount 5 or more of each KIT		
	Sub-total	\$

Ohio Residents add 6% sales tax |

If order is under \$30 ADD \$2 S/H |

will this HRD+ be used with the Geneve?? AMOUNT ENCLOSED \$

your signature X _____

Feedback

Comments from Germany

As a very interested reader I can't resist saying (writing) something about a few articles in your magazine.

The review (Oct. 87) about the 80-Column Card from Mechatronic: This article was very funny to read! About two weeks before receiving the MICROpendium I purchased the card. As a programmer in nearly all languages on the TI I tried to discover the powers of it. And, believe me, I was very thorough! After a few days I knew all theoretical powers of the card.

Because of this I can't believe what Mack McCormick has written. (As I heard, he even has no TI any more!) The installation was a snap, that's true. But the documentation for it is anything but detailed. The "helpful" pictures are evolved from the wrong side. But no matter: The quality of the reproductions are so bad, there was no way to disentangle them!

But there are a few other points more. The card hasn't 128K of RAM but 192K VDP RAM. But even with more RAM than said in the article the card isn't able to create 4096 colors; 256 is the maximum. But this isn't all! Mack forgot one important thing: There was no documentation for the graphic utilities of the card. I know, Mack is a great crack in programming. But what about all those TI users that will buy this card and want to see a little bit of these many colors? Perhaps I should specify that there are two modes available: The first allows only the normal 16 colors. But you may plot on 512 to 212 pixels! The second mode can be accessed on 256 to 212 pixels in 256 colors. The card itself with its built-in software doesn't support more modes. The processor could do much more (see MSX-II)! In my opinion, the card really is worth every penny. But I think no one should be decoyed to buy it with wrong information about it.

**Michael Rittweger
Kiel, West Germany**

Spin-to-Win followup

In our letter (Jan. 88) we pointed out that we'd discovered a problem in trying to use a "LOAD" program along with a RANDOMIZE in making our game "Spin-to-Win."

Since then, we've done some detective work in the TI99/4A, using the CALL PEEK to look at the random number and random number seed locations in memory. What we found is that, when a program runs automatically as a LOAD program, the computer puts a fixed number in the seed location. Thus a RANDOMIZE carried out after such a program has run uses this fixed seed and produces the same random number sequence every time it starts.

After some experimenting with PEEKs into the memory locations where the random number, the seed and the VDP timer are located, we came up with a way out of this problem. The way is to insert the following single line in the load program itself:

```
CALL PEEK(-31880,A,B):: CALL INIT ::  
CALL LOAD(-31808,A,B)
```

This procedure will place a "true" random number in the seed location, so that RANDOMIZE will work correctly after the LOAD program runs. We have incorporated this into our own program and run exhaustive tests, so we're sure doing this won't mess up anything else.

We hope that others will benefit from this small discovery, and that programs such as our competitor's QS-Wheel will work better for their users.

**Bruce Harrison
Harrison Software
Hyattsville, Maryland**

Checksum suggestion

I would like to suggest the addition of this line to the end of the Call Load version of Tom Freeman's checksum program which you published in your October 1987 issue: 400 CALL LOAD(-31952,255,231,255,231)

When you run Tom's program as published you are left with a nice little title screen and the XBASIC Call Load still in memory. It is hard to type in program listings with another program still in memory. However, if you type NEW (enter) to get rid of the program in memory this also gets rid of the title screen and turns off the checksum routine. You have to type CALL LINK ("ON") to turn on the checksum routine again before you start typing in a program listing. The above code automatically deletes the Call Load program from memory after it has run, but does not dis-

turb the title screen and does not turn off the assembly checksum routine.

I discovered this little coding gem in the August 1984 issue of *The Smart Programmer*. Apparently you can use it at the end of any XBASIC program if you want the program to erase itself without erasing the screen or affecting assembly routines in low memory expansion. The effect on screen display is similar to what END or STOP do from within a running program.

**Charles Good
Venedocia, Ohio**

Cursor speed control

After reading Mr. Elton Schooling's letter (Dec. '87) regarding cursor speed control in TI Artist, I felt it was necessary to reply to his request for help.

While in the drawing mode of TI Artist the cursor speed can be toggled between fast and slow mode by pressing the function and semicolon keys simultaneously (FCTN ;). Although it is difficult to find this speed control toggle key in the TI Artist manual, it does appear on the page marked "Key Layout." This particular page also provides valuable information about controlling the cursor, color and pen mode.

**Stephen C. Lamberti
Texaments
Patchogue, New York**

Columnist grateful

Thank you, Warren Agee (Feedback, Nov. '87) for pointing out and clarifying my goofs in my c99 article. I wish to especially thank you for your explanation of the way c99 handles char and int variables internally. This has been a puzzle to me since, as you know, any integer less than 128 requires only 7 bits and can fit into one byte. You have cleared up a lot for me. I shall continue to treat the programs as much as possible like standard C even though c99 might handle things differently internally to obtain the same result. Will point out the differences when possible. My only hope is to stimulate enough interest in the language to attract those who haven't tried. Personally, I like to think of integers as int and characters as char.

**Charles E. Kirkwood Jr.
Clemson, South Carolina
(See Page 10)**

TEX-COMP™**PRESENTS:****DEMO DISKS****SPECIAL!! ONLY \$4.95 each +s&h****NEW LOW PRICE \$4.95 each**

A NOTE ABOUT DEMO DISKS: TEX-COMP's demo disks are a collection of disks containing unique and entertaining features which we believe will help you get more out of your TI-99/4A. Some if not all of them are in the public domain. However, in certain cases, the author requests a contribution if you use and enjoy it. While you are not legally obligated to do so, we at TEX-COMP encourage your assisting these talented programmers if you enjoy their work. That is why we offer these disks at such a low price.

"THE SINGING TI-99/4A"**SPEECH & MUSIC DEMO DISK**

This is the disk everyone is talking about. The computer voice actually sings to animated graphics. Created by master programmer Ken Gilliland. It includes the now classic Bert & Ernie routine, Matilda and much much more. 32K.ExBasic, Speech Syn required.

WHEEL OF FORTUNE, BLACKJACK, AND JOKER POKER

Three fantastic freeware programs one one disk by a great exbasic programmer, Terry Staph. Professional quality and the best "wheel" program at any price.

DUMPIT DEMO DISK

This disk helps you transfer programs from many TI modules to disk. Recommended only for users with some programming knowledge and use of ExBasic and Ed/Assem. Instructions are included on disk on VAR 80 file.

PRINTART DEMO DISK

This two sided disk is a collection of programs that print out pictures of near photographic quality on most printers. Many familiar TV and comic characters are on this disk.

ORIGINAL TI-99/4A SALES DEMO DISK WITH TI-TREK GAME

This disk is packed fill of demo programs that were supplied to original dealers such as TEX-COMP by TI. Contains demos of graphics, speech, personal record keeping and games. Includes documentation and TI-TREK, a great computer game that talks. Speech and TE-II required. on some programs.

TI MUSIC/GRAPHICS DEMO DISK

Contains a great collection of music and matching animated graphics. Great examples of music and sprite programming.

EXBASIC MUSIC DEMO DISK

A collection of beautiful arrangements of popular hits. Includes a great exbasic catalog/loader program that can be used on your other disks.

SPACE SHUTTLE MUSIC/GRAPHICS DEMO DISK

One of the finest examples of TI-99/4A programming that we have seen. A long running epic saluting our space program. This is one disk you will run over and over again. A must for every TI-99/4A owner. Wonderful examples of graphics, music, and successive file access and display.

LOTTO DEMO DISK

This program randomly selects numbers for typical lotto games and even runs a simulated game. Easy to modify for a specific game like pick six. Great disk for fun and learning random number generation features in programming.

MONA LISA PRINT OUT

Now you can print out a fantastic likeness of this classic with the seductive smile. We understand that it was made by digitizing a video scan of the original on another computer and converting the code to run on the TI-99/4A. Everyone who sees the printout is impressed.

GOTHIC PRINT DEMO DISK

This disk lets you type out a message and then print it out in a fancy gothic type style that looks like hand lettered calligraphy. Great for making invitations, announcements, and business cards. A great learning disk as are all demo disks offered by TEX-COMP.

ANIMATED CHRISTMAS CARD

A wonderful example of computer graphics and animation by master programmer Ray Kazmer. Loaded with programming features that you will use over and over.

TI-99 OLOPY DEMO DISK

This great piece of programming actually simulates and plays the famous board game. For legal reasons we cannot give out the name of the original game but "do not pass go...go directly to jail".

STRIP POKER (PG RATED)

Play poker against your 99/4A. When you win a hand, she loses..a piece of her clothing with a surprise ending.

FIGURE STUDY DEMO DISK (PG RATED)

This disk contains a collection of files that print out Playboy type centerfolds. Use with any printer.

STAR/EPSON PRINTER DEMO DISK

A disk that contains a large collection of files and programs that put your Star or Epson compatible printer through its paces. You can list out any program to see how the various text and graphics were created. A great learning tool.

SIDEWAYS PRINTOUT DEMO DISK

This program allows you to print out material from your printer sideways. Great for spreadsheet displays, banners etc. Can be modified for various printers.

TI FORTH DEMO DISK

This demo disk was distributed by TI some time back. Contains wonderful music and graphics written in forth. Requires 32K and Ed/Assem to run.

TI DIAGNOSTIC DISK

This program loads into your Mini Memory module (required) and checks out your entire TI system. Developed by TI and provided to dealers for distribution to customers. Complete documentation on second disk side.

TI WRITER/MULTIPLAN UPGRADE DISK

This disk was released by TI to upgrade your original TI Writer and Multiplan. Adds a number of features to TI Writer including real lower case. Also speeds Multiplan up.

ACCOUNTS RECEIVABLE**FROM TEX-SOFT**

THIS IS THE PROGRAM THAT WON THE BEST PROGRAM OF 1983 FROM THE IUG. WRITTEN BY A PROFESSIONAL PROGRAMMER, THIS PROGRAM RUNS ON EX-BASIC AND HAS ALL THE FEATURES FOUND IN A FULL BLOWN BUSINESS ACCOUNTING SYSTEM. WITH DOCUMENTATION AND UNPROTECTED FOR LEARNING AND MODIFICATION.....ONLY \$4.95

IMPORTANT DEMO DISK NOTICE: All demo disks sold by Tex-Comp have been reviewed and determined to offer valuable educational and entertainment features to the user. There is no warranty or guarantee that they are free from bugs and most likely are not although we are not aware of any. Certain of these disks may include a claim of copyright from the author with the right to distribute at no charge expressly or impliedly granted providing the ultimate user pays a suggested amount or in some cases an amount that the user feels is fair. Tex-Comp encourages that payment to the author of a reasonable amount be made when requested. Tex-Comp will review any program for inclusion in this demo disk program however the final decision is that of Tex-Comp. Be sure that a request for payment is on the screen display and that any documentation is in the program or on the disk such as a "read this" text file preferably menu accessible from exbasic. Send any disks for consideration to Tex-Comp Demo Disk Program, P.O. Box 33084, Granada Hills, CA 91344. Disk cannot be returned and become the property of Tex-Comp. All submitters warrant and represent that the software submitted is their property.

Send order and make checks payable to:

TEX-COMP

P.O. Box 33084, Granada Hills, CA 91344



AUTHORIZED DEALER

VISA and MASTERCARD
HOLDERS CALL DIRECT**(818) 366-6631**

24 Hour Order Line

TERMS: All prices FOB Los Angeles. For fastest service use cashiers check or money order. Add 3% shipping and handling (\$3.00 Minimum). East of Mississippi 4 1/2%. Add 3% for credit card orders. Prices and availability subject to change without notice. We reserve the right to limit quantities.

NOTE: Payment in full must accompany all orders—credit card, company check or money order for immediate shipment. Personal checks require up to 4 weeks to clear. California orders add 6 1/2% sales tax.

Feedback

(Continued from Page 8)

Thanks for response

I've been rather "disenchanted" for a long time, as other software authors must have been, with the rather meager results I have had from Freeware, or Fairware as I prefer to call it. But not any more!

I wrote a little demo program (not even a game!) that I called "Woodstock's Christmas" and decided I would just give it away free to whoever wanted it. I did tack an "if you WANT to send \$2" message on it, just to see if anybody would take the time to respond.

The results have been incredible....At first, I tried to send a "thank you note" back to everybody who had written, but I simply can't keep up with the volume of mail! I wanted to say "thank you" to everyone here in MICROpendium. (I don't know what else to do!)

Several people sent well over the \$2 request and two user groups actually made "collections" at their meetings, then sent a "lump-sum" check. My special thanks go to Mr. Steve Mehr of the Tri-Valley 99ers, Thousand Oaks, California, and also to Mr. Charley Summerhill of the North County 99ers Users Group, Escondido, California, and to each of the members of these groups.

If any MICROpendium reader wants a copy of "Woodstock's Christmas," even though it's well into the New Year, just send me an initialized disk (any density) with a stamped, self-addressed mailer and I'll record it for them, free. Of course, if they want to include \$2, who knows, I may even add a little bonus! Sorry, but 99ers outside the United States MUST include \$5 in U.S. funds, and I will provide air mail postage to return their disks.

Ray Kazmer
13225 Azores Ave.
Sylmar, CA 91342

User supported software

First, let me thank you for the valuable service of listing User Supported Software. Many of the programs listed are important to people with special needs and would not be available otherwise.

Please allow me to clarify the listing in

the Nov. '87 issue for DUMPFAS software, which is a group of XBASIC graphic screen dump routines for GP-100TI, Seikosha GP-250, Gorilla Banana, and Epson printers. The listing indicates that a disk should be sent (with postage prepaid return mailer). Actually, these routines are available on cassette, also. Many printers were sold with a stand-alone interface (e.g. Axion) for a modestly configured TI99/4A system. This software was created to work with only the requirements of XBASIC and a printer. However, some extra keyboard work is required for programs already stored with a cassette based system. These routines are only about 30 to 40 lines of code each. Also, if you have a friend with a disk system, merging files is easy.

Next, I have a comment regarding another listing in November for DUMPX2 software, which does rightside-up, double-size dumps of XBASIC graphics (except for a very small slice on each side of the screen) with an Epson and is very fast (assembly code). No one has requested this. I am completely mystified as to why not. The big advantage to a rightside-up, double-size dump is that the printed screen will be properly oriented for text or other graphics that might appear on the same page. SDUMP II won't do this and I couldn't find anything else that would. I had to write my own, even for the Epson. So, I thought I would do everyone a favor and offer this via User Supported Software, but there are no takers yet (what is going on out there?). Anyone who runs the fancy calendar demo that comes with it will see the usefulness of this routine. I've lowered the suggested donation to \$4 (req. Disk, 32K).

Richard J. Marlen
Arnold, Missouri

TI-Artist printouts

In response to Elton Schooling (Aug. '87), I have been getting good printouts using TI-Artist and the GP550 printer. I press C for Hard Copy, then, at the menu, I press 4 for GP-550A, then when asked for the printer device name, I use the default of PIO.CR.LF, but if Mr. Schooling has a different hardware configuration he may need to enter AXIOM.CR.LF. When

prompted for the magnification factor, enter either 1 or 2 (3 doesn't work). At the line spacing prompt, enter the default 8.

If the above doesn't produce a printout, I'd strongly suspect that Mr. Schooling has a bad copy of TI-Artist on his disk.

I recently spoke to Chris Faherty, the author, about the problem with the magnification factor 3. He was unaware of the problem, and is currently looking into it. He has promised to respond when he concludes testing.

Shirley Slicer
Olathe, Kansas

Harmful error

I don't know how many readers have heard an old squib that states "you can't harm a computer by errors in a program."

Well, I have news for you; the 99/4A was not informed about that. I have destroyed the 62643 RAM chips in two Super Cartridges in the past two weeks during test phase of new program code that had been loaded into the cartridge's 6264 RAM. I cannot determine what is happening, except that there were some errors in the code in spots; when it attempted to execute the stuff, the CPU went crazy. The console is not damaged so far as I can tell.

Merle Vogt
Von Ormy, Texas

Cassette and disk

Can MICROpendium define wording substitutions or differences between cassette uses and disk uses?

Besides, how does a computer know whether it's connected to a disk or cassette or not?

James E. Yates
Burgettown, Pennsylvania
Briefly, CSI or CS2 is the cassette equivalent of DSK1 or DSK2 for floppy disk drives. Data is written and read sequentially from a cassette. Data files for a database program, for example, must be loaded completely into memory to be manipulated. With a disk system, data files can be written to the disk non-sequentially and accessed randomly so that it isn't necessary to load the data files into memory before manipulating the data. The designation CSI or DSK1, etc., directs the computer to the proper port.



112 RAMBLING ROAD
VERNON, CT 06066

(203) 871-7824

ADD 5% FOR HANDLING AND SHIPPING.
CT. RESIDENTS ADD 7.5% SALES TAX.



VISA & Master Card Add 3%



INTRODUCES.....

R A V E 9 9 M E M O R Y
E N H A N C E M E N T S Y S T E M

Need a memory card? Buy the one that can be expanded as your needs change. Think MX01!!! Not enough room to fully describe system. Call or Write for more Details!!

The NEW Memory Enhancement Card allows memory expansion for the TI-99/4A up to 544K bytes of backedup memory. Up to FOUR (4) memory cards may be installed in the PEB which allows access to over 2 MEGABYTES of BACKED-UP memory. o Three Models Available

- ** Model MX01/64 - \$199.95 Includes
8K BYTES of memory at >6000 -> >7FFF
8K BYTES Non-DSR Memory, 8K BYTES System DSR Memory, 8K BYTES User DSR Memory, 32K BYTES Main Memory, ONLY VERY Low-Power Memories are used, Advanced Memory Backup Design
Expansion sockets to increase memory to 544K.
- ** Model MX01/288 - \$299.95 Same as MX01/64 W/256K of main memory
- ** Model MX01/544 - \$399.95 Same as MX01/64 W/512K of main memory

NEW!



MODEL 99/105 KEYBOARD ENHANCEMENT

THE FOLLOWING ARE STANDARD FEATURES ON THE MODEL 99/105 KEYBOARD ENHANCEMENT...

- * * INTERFACE LOGIC CARD WHICH INSTALLS EASILY IN CONSOLE WITHOUT SOLDERING. **\$199.95**
- * * 105 KEY KEYBOARD WITH 24 FUNCTION KEYS.
- * * SUPPORTS SINGLE KEY ENTRY OF ALL TI-WRITER, MULTIPLAN, AND EDITOR/ASSEMBLER COMMANDS.
- * * ATTRACTIVE LOW PROFILE KEYBOARD WITH ADJUSTABLE TILT ANGLE AND 5 FT. CORD.
- * * DEDICATED NUMERIC KEYPAD WITH NUMERIC OPERATORS.
- * * DEDICATED CURSOR CONTROL KEYS. **INCLUDES custom keyboard.**
- * * ENLARGED RETURN, SHIFT, AND CONTROL KEYS.
- * * OPTIONAL USER INSTALLED RESET AND LOAD INTERRUPT CAPABILITY FROM KEYBOARD.
- * * DETAILED INSTALLATION AND OPERATING INSTRUCTION MANUAL INCLUDED.

KEYBOARD INTERFACE CARD - \$149.95

- * * Interface card installs in 4A console in place of old keyboard and allows use of any IBM PC/XT compatible keyboard with your 99/4A. Interface card supports all 83 standard PC/XT key codes.
- * * Comes with complete, easy to follow installation and operating instructions. NO SOLDERING REQUIRED.
- * * Optional user installed RESET and LOAD INTERRUPT capability from keyboard. Complete instructions included.



KIT AVAILABLE

- * * Includes printed circuit board, complete instruction manual, and RAVE 99 custom chips. Hard to find hardware also included. Requires only assembly \$ 92.00. and about \$10.00 in easy to find components to complete.

* IBM & PC/XT are trademarks of International Business Machines

S P E E C H S Y N T H E S I Z E R A D A P T E R C A R D

- * * Finally, A low cost method to move your TI-Speech synthesizer from the side of the console to the Peripheral Expansion Box (PEB).
- * * Takes only minutes to remove the housing from your speech synthesizer and install into the P.E. Box.
- * * Compatible with the 99/4A and 9640 GENEVE computers.
- * * Software Compatible with TI-Speech Synthesizer.
- * * High Quality Construction, 90 Day Warranty
- * * LOW COST .. \$49.95 + \$2.50 for Shipping & Handling
- * * Units are in stock and ready for immediate delivery.
- * * Make someone happy, Put a "voice" back in your computer!!

NEW!

BASIC

Trigonometry functions

By REGENA

A student in high school trigonometry soon learns about angles in degrees and in radians (and the relationship between them). Then the trigonometric functions are learned — sine, cosine, tangent, cotangent, secant, cosecant. Some of the angles are so common that the student should “memorize” the functions and not need to turn to a printed trig table or a calculator.

When my second child needed to learn these angles, I realized that this topic should be in a computer program. Actually, several trigonometry concepts would make good programs. This month I have written a program that will help the student learn the trig functions of the angles 0, 30, 45, 60 and 90 degrees and their multiples.

A list of the angles is given at the right side of the screen. A circle is drawn with an x-axis and y-axis indicated. The student uses the up-arrow key (E) and down-arrow key (X) to indicate the angle, then the ENTER key is pressed to select that angle. The angle will be drawn on the circle, and the sine, cosine, and tangent of the angle will be listed. To choose another angle, press the space bar.

You actually need to memorize only the sine and cosine of the angle, because the other trigonometric functions may be derived from the sine and cosine. The tangent of an angle is the sine of the angle divided by the cosine of the angle. The cotangent is the reciprocal of the tangent. The secant is the reciprocal of the cosine. The cosecant is the reciprocal of the sine.

When you type in this program, be careful typing the DATA statements. Lines 290-330 are character definitions to define graphics characters to draw the circle. The DATA statements in Lines 420-450 are the sine, cosine and tangent of each angle. The % sign is redefined as a square root sign, the \$ symbol is redefined as a 2 under the square root sign and the # symbol is redefined as a 3 under the square root sign. The ! symbol is redefined as the infinity symbol, indicating an undefined number.

The PRINT statements in Lines 570-740 print the angles in radians and corresponding degrees. The letter P is redefined as the pi symbol, and the letter Q is redefined as a degree mark. The sub-routines are used to draw the angles on the circle and then to erase

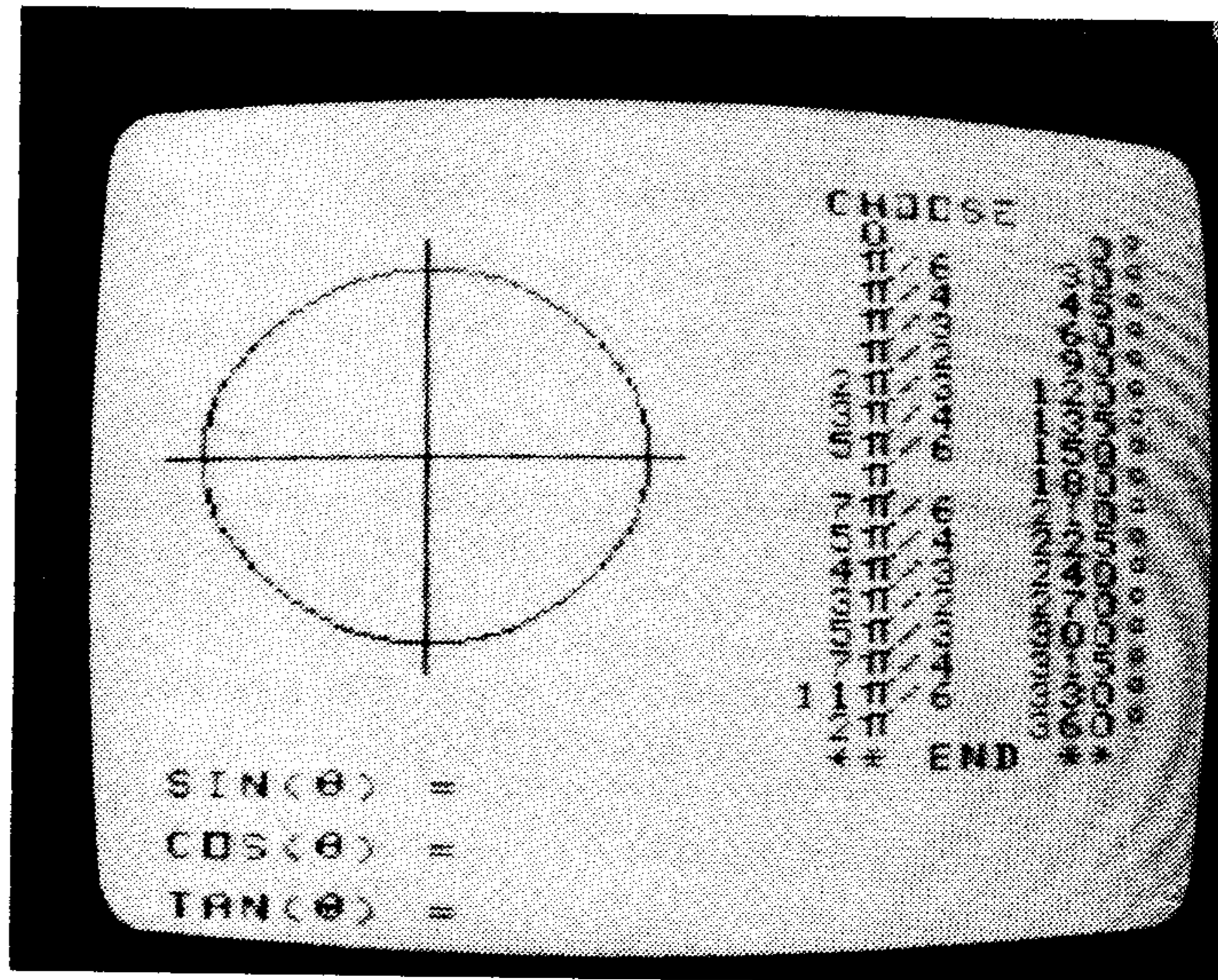

the angles when the space bar is pressed to choose another angle.

I will be looking forward to seeing many of my TI friends and meeting many more new people at the TI-xpo-ii combined with Fest West to be held this year at the Palace Station Hotel in Las Vegas, Nevada, Feb. 27-28. Contact the Southern Nevada User Group (SNUG, P.O. Box 26301, Las Vegas, NV 89126) if you need more information and would like to attend. I have certainly enjoyed visiting various TI conventions. At this one I will be trying something new — offering a debugging clinic. If you are having problems typing in a program or getting a program to work, or if you want me to review your program there, I'll take a look at it with you. By the way, this is a service only at the convention. I do not review programs by mail (unless you are having trouble with one of my published programs). I will have my programs then available for copying. And I'll also be there just to meet you and visit with you.

If you prefer to save typing effort, you can have a copy of this program by sending \$3 copying fee, plus a blank cassette or diskette and a stamped, self-addressed mailer to REGENA, P.O. Box 1502, Cedar City, UT 84720. Be sure to indicate that you need Trigonometry for the TI.

Trigonometry Program

```
100 CALL CLEAR !209
110 PRINT TAB(4); "TRIGONOMET
RY" !060
120 DIM SN$(16), CS$(16), TN$(
16) !015
130 CALL CHAR(58, "FF") !051
140 PRINT : "USE THE ARROW
KEYS TO" !154
150 CALL CHAR(59, "FF01010101
010101") !233
160 PRINT : "CHOOSE AN ANGLE,
THEN" !159
170 PRINT : "PRESS <ENTER>."
!249
```

```
180 PRINT : "THE ANGLE WILL BE
DRAWN" !050
190 CALL CHAR(63, "FF80808080
80808") !228
200 PRINT : "AND THE TRIGONOM
ETRIC" !007
210 CALL CHAR(64, "0101010101
0101FF") !229
220 PRINT : "FUNCTIONS LISTED
." !245
230 PRINT : "PRESS THE SPACE
BAR" !058
240 PRINT : "TO CHOOSE ANOTHER
ANGLE." !154
```

```
250 FOR C=128 TO 159 !014
260 READ C$ !254
270 CALL CHAR(C, C$) !081
280 NEXT C !217
290 DATA FF, 00F00F, 000000C0,
0080601, C02018040201, 000000,
00000804, 2010080404020101, 8,
40402010100808 !009
300 DATA 04040404020202, 0,
01010101010101, 020202020404,
404, 080810102040408, 0101020,
0408102, 408 !194
310 DATA 00000102041820C, 011
(See Page 14)
```

THE GENEVE 9640 HAS LANDED

You will recognize it by its trade mark, a graceful gray swan swimming on blue water, an apt symbol. The ugly duckling TI no longer wanted, is no ugly duckling anymore. The GENEVE has surpassed everyones expectations, even our own; with power, speed, graphics, and adaptibility not found in other microcomputers. In fact, the GENEVE does so much, this ad can only begin to tell you about it.

- **Near 100% Compatible:**
 - If you have a program written in Basic, Extended Basic, XBI, Assembly Language, Forth, Pascal, you name it, if it runs on the 99/4A then it is near certain to run on the GENEVE.
- **32K No Wait State High Speed RAM:**
 - Programs like MultiPlan, which are painfully slow on the 99/4A, run many times faster, thanks in part to the High Speed RAM.
- **V9938 Video Processor with 7 Graphics Modes:**
 - Compatible with the 99/4A so you can use the GENEVE with the TV or monitor you are currently using. Same resolution as the Mac but with color. Faster than the Amiga, as fast as the Atari and does it with true aspect ratio, something the Amiga and IBM AT can not do. Aspect ratio renders higher resolution, better color, and appearance, through the use of square pixels. In the high resolution mode, 256 colors may be displayed on the screen at one time by the GENEVE, eight times as many as the Amiga can display in its high resolution mode.
- **Mouse Interface:**
 - The mouse interface is built in and ready to use with the MYARC mouse. But, we didn't stop there, it is also ready to support the newest hardware, like video digitizers, and that's just for starters.
- **6 Complete Pieces Of Software Are Included WithThe GENEVE. But, three you will not be able to see how you ever did without are:**
 - My-Word Processor; 80 columns, help screens for all modes of operation including control-U, initialize a disk without leaving the program, print formatted text to the screen for viewing before sending it to the printer and that's still not all My-Word will do.
 - Advanced Basic; the best and most powerful basic on the market today.
 - Pascal V4.21; if you have a standard USCD Pascal program, you will be able to run it with this program. If you do not have any Pascal programs, let me tell you, one of the largest library of programs available, is Pascal. Compilers for Fortran, Modula 2, Lisp, and Pilot, as well as business programs from A to Z, are all there. USCD Pascal Software developed for computers from Apple to IBM, will run on the GENEVE, without modification.

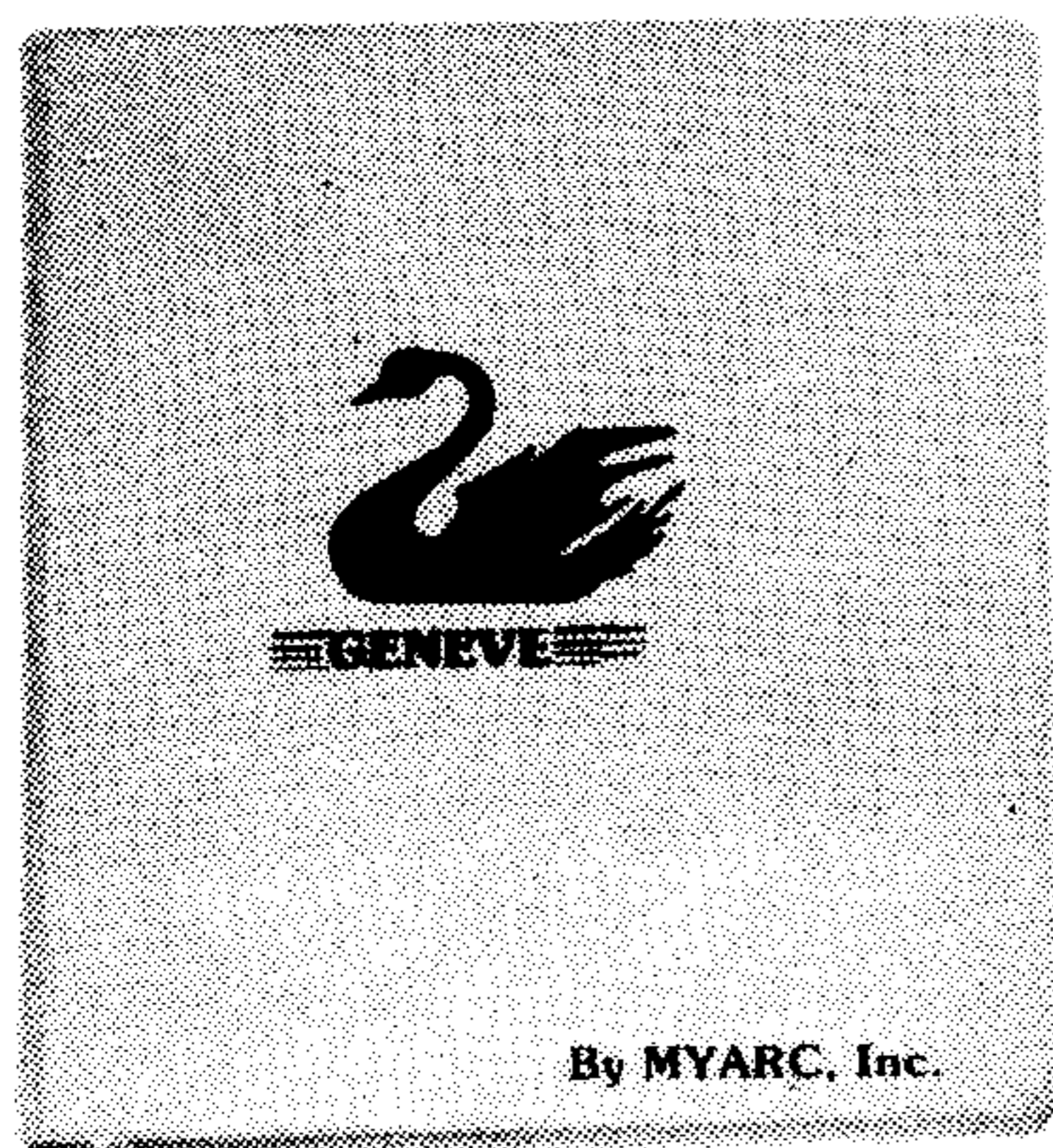
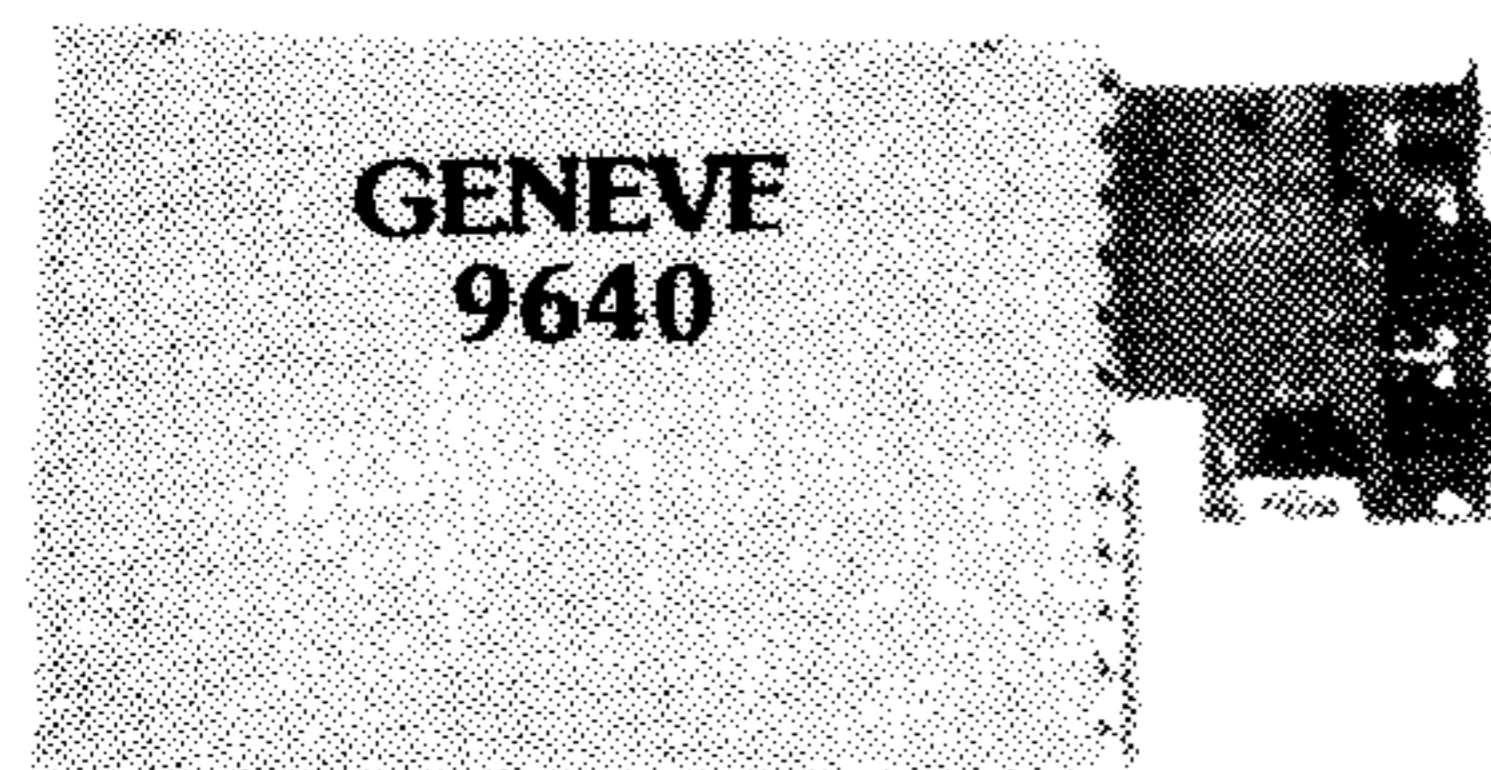

If you have heard enough, contact your MYARC dealer, they have one in stock for you. If you do not know who your stocking MYARC dealers are, or, if you want to know more about the GENEVE, telephone the number listed below, or mail your name and complete address with zip code to the address shown below. We will be happy to mail you a brochure covering the GENEVE in detail and a list of our stocking dealers. Supplies of the brochure are limited, so please hurry.

GENEVE
P. O. Box 140
Basking Ridge, New Jersey 07920-1014
(201) 766-1700

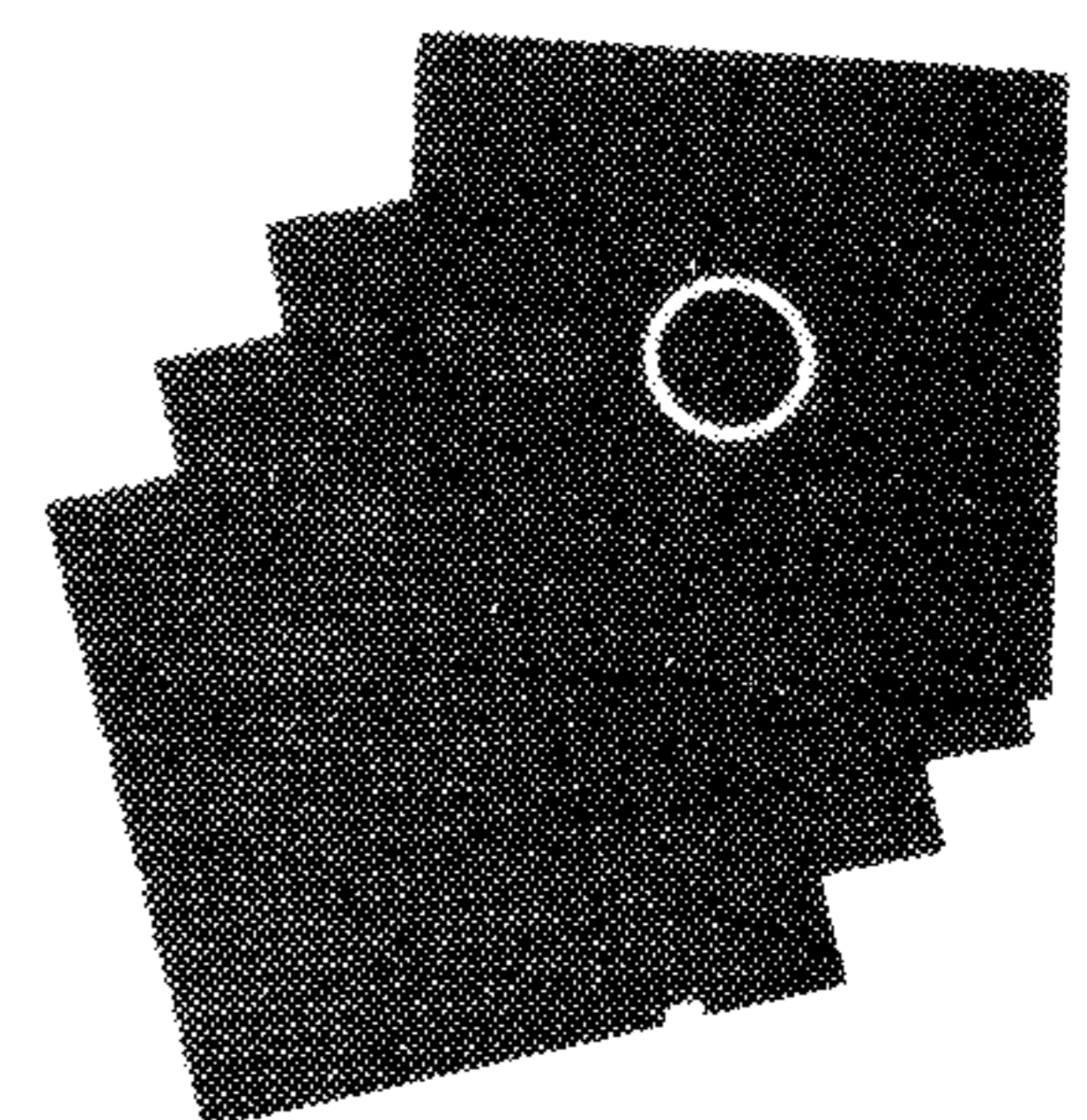

TRIGONOMETRY—

(Continued from Page 12)

```

60830C,000000000000FF,00000000
00000000FF,0000000000F00F,806
0100C03 !114
320 DATA 0000804020180403,02
01,8080402020100804,10100808
04020201,404040402020202,808
0808080808 !045
330 DATA 202020204040404,010
202040808101,040810202040808
,0000000000000102,0304182040
8,000000030C10608,000FF !163
340 CALL CHAR(33,"006C929292
6C")!061
350 CALL CHAR(37,"0001010212
0A0A04")!223
360 CALL CHAR(35,"FF001C2204
08103E")!025
370 CALL CHAR(36,"FF003C020C
02023C")!034
380 CALL CHAR(90,"080402FF02
0408")!151
390 FOR C=0 TO 16 !104
400 READ SN$(C),CS$(C),TN$(C
)!082
410 NEXT C !217
420 DATA 0,1,0,1/2,%$/2,%$/3
,%#/2,%#/2,1,%$/2,1/2,%$,1,0
,! !058
430 DATA %$/2,-1/2,-%$, %#/2,
-%#/2,-1,1/2,-%$/2,-%$/3,0,-
1,0 !134
440 DATA -1/2,-%$/2,%$/3,-%#
/2,-%#/2,1,-%$/2,-1/2,%$,-1,
0,! !119
450 DATA -%$/2,1/2,-%$,-%#/2
,%#/2,-1,-1/2,%$/2,-%$/3,0,1
,0 !088
460 PRINT : : "PRESS ANY KEY
TO START." !033
470 CALL KEY(0,K,S)!187
480 IF S<1 THEN 470 !224
490 CALL CLEAR !209
500 CALL CHAR(60,"0101010101
010101")!182
510 CALL CHAR(62,"FF01010101
010101")!227
520 CALL SCREEN(8)!153
530 CALL CHAR(80,"013EE42424
2424")!152
540 CALL CHAR(81,"18242418")
!071
550 PRINT TAB(19); "CHOOSE" !
123
560 T=19 !070
570 PRINT TAB(T); " 0      0Q
" !111
580 PRINT TAB(T); " P/6    30Q
" !199
590 PRINT TAB(T); " P/4    45Q
" !203
600 PRINT TAB(T); " P/3    60Q
" !199
610 PRINT TAB(T); " P/2    90Q
" !201
620 PRINT TAB(T); "2P/3   120Q
" !230
630 PRINT TAB(T); "3P/4   135Q
" !238
640 PRINT TAB(T); "5P/6   150Q
" !239
650 PRINT TAB(T); " P      180Q
" !184
660 PRINT TAB(T); "7P/6   210Q
" !238
670 PRINT TAB(T); "5P/4   225Q
" !240
680 PRINT TAB(T); "4P/3   240Q
" !235
690 PRINT TAB(T); "3P/2   270Q
" !236
700 PRINT TAB(T); "5P/3   300Q
" !233
710 PRINT TAB(T); "7P/4   315Q
" !242
720 PRINT TAB(T-1); "11P/6  3
30Q" !217
730 PRINT TAB(T); "2P     360Q
" !202
740 PRINT TAB(T); "** END **"
!156
750 A=0 !248
760 CALL CHAR(122,"010204081
020408")!203
770 CALL CHAR(125,"FF")!095
780 CALL CHAR(126,"010101010
1010101")!234
790 CALL CHAR(127,"804020100
8040201")!001
800 CALL COLOR(12,7,1)!227
810 CALL CHAR(39,"1824447C44
4438")!158
820 PRINT "SIN( ) =" !042
830 PRINT : "COS( ) =" !218
840 PRINT : "TAN( ) =" ; !140
850 CALL HCHAR(10,3,58,14)!2
27
860 CALL VCHAR(3,9,60,14)!19
3
870 RESTORE 920 !248
880 FOR C=1 TO 38 !109
890 READ ROW,COL,G !026
900 CALL HCHAR(ROW,COL,G)!19
2
910 NEXT C !217
920 DATA 10,9,62,4,10,128,4,
11,129,4,12,130,5,13,131,5,1
4,132,6,14,133,7,15,134,8,15
,135,9,15,136 !073
930 DATA 10,15,59,11,15,137,
12,15,138,13,14,139,14,14,14
0,14,13,141,15,12,142,15,11,
143,15,10,144 !088
940 DATA 15,9,64,15,8,145,15
,7,146,14,6,147,14,5,148,13,
5,149,12,4,150,11,4,151,10,4
,63 !131
950 DATA 9,4,152,8,4,153,7,4
,154,6,5,155,5,5,156,5,6,157
,4,7,158,4,8,159,4,9,62,4,9,
62 !091
960 CALL SOUND(150,440,2)!13
3
970 CALL KEY(0,K,S)!187
980 CALL HCHAR(2+A,19,90)!00
7
990 CALL HCHAR(2+A,19,32)!00
3
1000 IF K=13 THEN 1110 !142
1010 IF K<>69 THEN 1060 !040
1020 A=A-1 !252
1030 IF A>=0 THEN 970 !130
1040 A=0 !248
1050 GOTO 970 !028
1060 IF K<>88 THEN 970 !206
1070 A=A+1 !251
1080 IF A<18 THEN 970 !253
1090 A=17 !049
1100 GOTO 970 !028
1110 IF A=17 THEN 2990 !231
1120 CALL HCHAR(2+A,19,90)!0
07
1130 ON A+1 GOSUB 1310,1370,
1490,1590,1710,1760,1880,198
0,2110,2170,2300,2400,2530,2
590,2720,2820,1310 !028
1140 M$=SN$(A)!162
1150 R=20 !060
1160 GOSUB 2940 !215
1170 R=R+2 !030
1180 M$=CS$(A)!151
1190 GOSUB 2940 !215
1200 R=R+2 !030
1210 M$=TN$(A)!163
1220 GOSUB 2940 !215
1230 CALL SOUND(150,440,2)!1
33

```

(See Page 16)

1988 The Year Of The Upgrade Not The Up Trade

**A COMPLETE EXPANSION SYSTEM
9900 + FOR THE TI99/4A
THE ULTIMATE
99/4A EXPANSION SYSTEM
AT A SPECIAL
PRICE FROM TEX+COMP™**

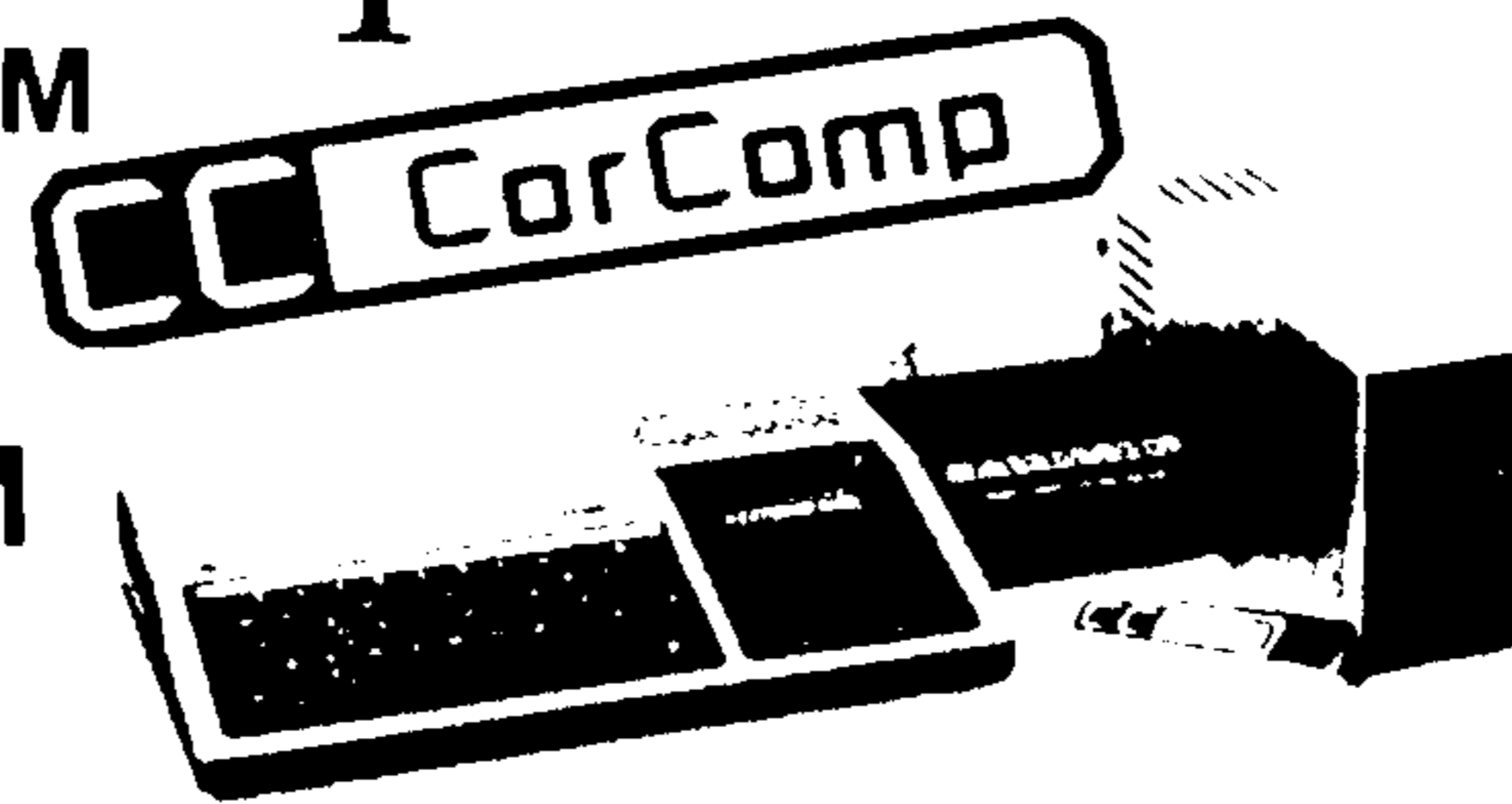

CorComp

**COMPLETE
EXPANSION SYSTEM
NOTHING ELSE TO BUY!**

TEX-COMP, the undisputed leader in supplying the 99/4A User, has now put together the finest and most complete expansion system ever offered for the TI99/4A.

- **9900 Expansion Box & Regulated Power Supply (UL Approved)**
- **32K Memory Upgrade** Adds 32K bytes of Random Access Memory to your system.
- **Double Sided/Double Density Disk Controller** (operates up to 4 drives)
- **RS232 Interface** Lets you add a wide range of other accessories, such as printers or telephone modems, one parallel and 2 serial outputs.
- **1 SS/SD Disk Drive** Allows you to store and retrieve data on 5 1/4-inch single- or double-sided floppy diskettes.
- **1 Disk Drive Case & Regulated Power Supply**
Handles two 1/2-height drives easily (UL or LAC Approved)
- **New Disk Manager with Improved Disk Utilities**
- **All Cables & Instructions** Including a free TI RS232 Y-Cable.

**ALL FOR
\$379.95**
Plus S&H

For above system with full size or 1/2-height DS/DD Drive	SPECIFY	\$399.95
For above system with a pair of 1/2-height DS/DD Drives	NEW LOW PRICE	499.95

CorComp RS232 Card (for TI P-Box)	79.95
CorComp 32K Card (for TI P-Box)	99.95
CorComp 256K P-Box Card	169.95
CorComp 512K P-Box Card	229.95
CorComp DS/DD Controller (for TI P-Box)	149.95
CorComp 9900 System with Free RS232 Y-Cable	299.95
CorComp Stand Alone RS232 with Free Y-Cable	99.95
CorComp Stand Alone 32K	89.95
Triple Tech P-Box Card (Clock/Buffer)	119.95
9900 Clock Stand Alone	69.95
"Grom Buster" (for 1983 Consoles)	24.95
Load Interrupt Switch (with FREE Screen Dump Program)	19.95
PDI Diagnostic Module	24.95
NEW "Writer-Ease" Word Processor & Spell Check New Lower Price	39.95
IBM Connection (39.95 with Controller Card)	49.95
1/2-Height DS/DD Disk Drive (2 will fit in P-Box)	New Lower Price 89.95
Full Size SS/SD Disk Drive (exact replacement for TI 1250)	59.95
Full Size DS/DD Disk Drive	79.95
Drive Enclosure with Regulated Power Supply for 2 1/2-height or 1 full Drive	39.95
Cable Kit for 2 1/2-height Drives (for installation in P-Box)	29.95

Send order and make checks payable to:

TEX+COMP

P.O. BOX 33064 - GRANADA HILLS, CA 91344



VISA and MASTERCARD
HOLDERS CALL DIRECT
(818) 366-6631
24 Hour Order Line

TERMS: All prices FOB Los Angeles. For fastest service use cashiers check or money order. Add 3% shipping and handling (\$3.00 Minimum). East of Mississippi 4 1/2%. Add 3% for Credit Card orders. Prices and availability subject to change without notice. We reserve the right to limit quantities.

NOTE: Payment in full must accompany all orders—credit card, company check or money order for immediate shipment. Personal checks require up to 4 weeks to clear. California orders add 6 1/2% sales tax.

TRIGONOMETRY—

(Continued from Page 14)

1240 CALL KEY(0,K,S)!187
1250 IF K<>32 THEN 1240 !210
1260 ON A+1 GOSUB 1330,1450,
1540,1670,1730,1840,1930,206
0,2130,2250,2350,2480,2550,2
670,2770,2900,1330 !204
1270 CALL HCHAR(20,11,32,6)!
220
1280 CALL HCHAR(22,11,32,6)!
222
1290 CALL HCHAR(24,11,32,6)!
224
1300 GOTO 960 !018
1310 CALL HCHAR(10,10,125,6)
!014
1320 RETURN !136
1330 CALL HCHAR(10,10,32,6)!
218
1340 CALL HCHAR(10,10,58,5)!
225
1350 CALL HCHAR(10,15,59)!05
4
1360 RETURN !136
1370 CALL CHAR(123,"00000000
030C30C")!218
1380 CALL CHAR(124,"030C30C"
)!083
1390 CALL HCHAR(9,10,123)!04
9
1400 CALL HCHAR(9,11,124)!05
1
1410 CALL HCHAR(8,12,123)!05
0
1420 CALL HCHAR(8,13,124)!05
2
1430 CALL HCHAR(7,14,123)!05
1
1440 RETURN !136
1450 CALL HCHAR(9,10,32,2)!1
73
1460 CALL HCHAR(8,12,32,2)!1
74
1470 CALL HCHAR(7,14,32)!001
1480 RETURN !136
1490 CALL HCHAR(9,10,122)!04
8
1500 CALL HCHAR(8,11,122)!04
8
1510 CALL HCHAR(7,12,122)!04
8
1520 CALL HCHAR(6,13,122)!04
8
1530 RETURN !136
1540 CALL HCHAR(9,10,32)!255
1550 CALL HCHAR(8,11,32)!255
1560 CALL HCHAR(7,12,32)!255
1570 CALL HCHAR(6,13,32)!255
1580 RETURN !136
1590 CALL CHAR(120,"10102020
4040808")!201
1600 CALL CHAR(121,"01010202
04040808")!251
1610 CALL HCHAR(9,10,120)!04
6
1620 CALL HCHAR(8,10,121)!04
6
1630 CALL HCHAR(7,11,120)!04
5
1640 CALL HCHAR(6,11,121)!04
5
1650 CALL HCHAR(5,12,120)!04
4
1660 RETURN !136
1670 CALL VCHAR(5,12,32)!011
1680 CALL VCHAR(6,11,32,2)!1
85
1690 CALL VCHAR(8,10,32,2)!1
86
1700 RETURN !136
1710 CALL VCHAR(4,9,126,6)!1
98
1720 RETURN !136
1730 CALL VCHAR(5,9,60,5)!14
6
1740 CALL VCHAR(4,9,62)!226
1750 RETURN !136
1760 CALL CHAR(120,"08080404
02020101")!250
1770 CALL CHAR(121,"80804040
2020101")!202
1780 CALL HCHAR(9,9,120)!005
1790 CALL HCHAR(8,9,121)!005
1800 CALL HCHAR(7,8,120)!002
1810 CALL HCHAR(6,8,121)!002
1820 CALL HCHAR(5,7,120)!255
1830 RETURN !136
1840 CALL VCHAR(5,7,32)!222
1850 CALL VCHAR(6,8,32,2)!14
2
1860 CALL VCHAR(8,9,60,2)!14
6
1870 RETURN !136
1880 CALL HCHAR(9,9,127)!012
1890 CALL HCHAR(8,8,127)!010
1900 CALL HCHAR(7,7,127)!008
1910 CALL HCHAR(6,6,127)!006
1920 RETURN !136
1930 CALL HCHAR(6,6,32)!208
1940 CALL HCHAR(7,7,32)!210
1950 CALL HCHAR(8,8,32)!212
1960 CALL HCHAR(9,9,60)!215
1970 RETURN !136
1980 CALL CHAR(123,"00000000
C0300C03")!011
1990 CALL CHAR(124,"C0300C03
")!132
2000 CALL HCHAR(9,9,123)!008
2010 CALL HCHAR(9,8,124)!008
2020 CALL HCHAR(8,7,123)!005
2030 CALL HCHAR(8,6,124)!005
2040 CALL HCHAR(7,5,123)!002
2050 RETURN !136
2060 CALL HCHAR(7,5,32)!208
2070 CALL HCHAR(8,6,32,2)!12
8
2080 CALL HCHAR(9,8,32)!213
2090 CALL HCHAR(9,9,60)!215
2100 RETURN !136
2110 CALL HCHAR(10,4,125,6)!
224
2120 RETURN !136
2130 CALL HCHAR(10,4,58,5)!1
79
2140 CALL HCHAR(10,9,62)!002
2150 CALL HCHAR(10,4,63)!254
2160 RETURN !136
2170 CALL CHAR(123,"00000000
030C30C")!218
2180 CALL CHAR(124,"030C30C"
)!083
2190 CALL HCHAR(10,9,124)!05
0
2200 CALL HCHAR(10,8,123)!04
8
2210 CALL HCHAR(11,7,124)!04
9
2220 CALL HCHAR(11,6,123)!04
7
2230 CALL HCHAR(12,5,124)!04
8
2240 RETURN !136
2250 CALL HCHAR(12,5,32)!253
2260 CALL HCHAR(11,6,32,2)!1
71
2270 CALL HCHAR(10,8,58)!006
2280 CALL HCHAR(10,9,62)!002
2290 RETURN !136
2300 CALL HCHAR(10,9,122)!04
8
2310 CALL HCHAR(11,8,122)!04
8
2320 CALL HCHAR(12,7,122)!04
8
2330 CALL HCHAR(13,6,122)!04
8
2340 RETURN !136
(See Page 18)

TI-TAX TI-TAX™ TI-TAX



NEW FEATURES ! NEW FORMS !
DO YOUR OWN TAXES AT HOME
GENERATE IRS APPROVED FORMS
USE YOUR TI-99:4A OR GENEVE

These EASY-TO-USE, HI-QUALITY, CROSS-LINKED templates:

- Generate and print IRS useable Forms and Schedules
- Can be used in lieu of IRS preprinted forms
(Except forms requiring signature -- now will overprint IRS Form 1040)
- Have grown each year since 1983; NOW INCLUDE TAX LAW CHANGES
- Can link to your other Multiplan(tm) records
- Are not copy protected. (Ask about "Fairware" rebates!)
- Are great for "What if...?"ing.
- Do most of your calculations

MAKE CHECKS TO:
 William G Chavanne
 4549 English Ave
 Ft Meade, MD 20755

DISK:	SHORTFORMS	LONGFORM	SCHEDULES	USUALFORMS	MOREFORMS
	\$19.95	\$9.95	\$19.95	\$19.95	\$19.95
CONTAINS:	FORM1040Ap1 FORM1040Ap2 FORM1040EZ SCHEDULE1p1 SCHEDULE1p2 PRINT17 REBATES FLOWCHART USER MANUAL	FORM1040p1 FORM1040p2 (Incl Schedules x,y,&z) PRINT17 REBATES FLOWCHART USER MANUAL	SCHEDULEA SCHEDULEB SCHEDULEC SCHEDULEDp1 SCHEDULEDp2 SCHEDULEEp1 SCHEDULEEp2	FORM2106p1 FORM2106p2 FORM2441 FORM3903 FORM6251 FORM8598 FORMW4wksheet	FORM1040X FORM2119 FORM4972p1 FORM4972p2 FORM8582 FORM8615 SCHEDULER SCHEDULESE

Output samples !

Add \$4.00 shipping and handling

SCHEDULES AND SCHEDULE A--Itemized Deductions DMB No. 1545-0074 Attachment Sequence No. 07 1987

Benefits as shown on Form 1040:

Medical and Dental Expenses (Do not include expenses reimbursed or paid by others.)

1a Prescription medicines and drugs, insulin, doctors, dentists, nurses, hospitals, insurance premiums you paid for medical and dental care, etc. 1a 10.00

b Transportation and lodging. 1b 10.00

c Other (list--include hearing aids, dentures, eyeglasses, etc.) 1c 10.00

2 Add lines 1a through 1c, and enter the total here. 2 20.00

3 Multiply the amount on Form 1040, line 31 (10.00), by 7.5%. 3 15.00

4 Subtract line 3 from line 2. If zero or less, enter -0-. Total medical and dental. 4 5.00

Taxes You Paid (See instructions on page 22.)

5 State and local income taxes. 5 5.00

6 Real estate taxes. 6 4.00

7 Other taxes (list--include personal property taxes) 7 1.00

8 Add the amounts on lines 5 through 7. Enter the total here. Total taxes. 8 10.00

Interest You Paid (See instructions on page 22.)

9a Deductible home mortgage interest you paid to financial institutions (report deductible points on line 10). 9a 10.00

b Deductible home mortgage interest you paid to individuals (show that person's name and address) 9b 10.00

10 Deductible points. 10 10.00

11 Deductible investment interest. 11 10.00

12a Personal interest you paid (see page 22). 12a 120.00

b Multiply the amount on line 12a by 651.651. Enter the result. 12b 78.20

Add the amounts on lines 9a through 11 and 12b. Total interest. 12 138.20

Contributions You Made (See instructions on page 23.)

14a Cash contributions. (If you gave \$3,000 or more to any one organization, report those contributions on line 14b.) 14a 140.00

b Cash contributions totaling \$3,000 or more to any one organization. (Show to whom you gave and how much you gave.) 14b 140.00

15 Other than cash. (You must attach Form 8283 if over \$500.) 15 15.00

16 Carryover from prior year. 16 1.00

17 Add the amount on lines 14a through 16. Enter the total here. Total contributions. 17 176.00

Casualty and Theft Losses

18 Casualty or theft losses (attach Form 4685). (See page 23 of the instructions.) 18 10.00

Moving Expenses

19 Moving expenses (attach Form 3903 or 3903F). (See page 24 of the instructions.) 19 10.00

Miscellaneous Deductions Subject to 22 AGI Limit (See instructions on page 24.)

20 Unreimbursed employee business expenses (attach Form 2104). 20 20.00

21 Other expenses (list type and amount) 21 21.00

22 Add the amounts on lines 20 and 21. Enter the total. 22 41.00

23 Multiply the amount on Form 1040, line 21, by 22.02%. Enter the result here. 23 9.03

24 Subtract line 23 from line 22. Enter the result (but not less than zero). 24 31.97

Other Miscellaneous Deductions

25 Miscellaneous deductions not subject to 22 AGI limit (see page 24). (List type and amount.) 25 25.00

Total Itemized Deductions

26 Add the amounts on lines 4, 8, 12, 17, 18, 19, 24, and 25. Enter the total here and on Form 1040, line 33a. 26 306.97

For Paperwork Reduction Act Notice, see Form 1040 instructions. Schedule A (Form 1040) 1987

Form 2106 Employee Business Expenses DMB No. 1545-0139 Attachment Sequence No. 54 1987

Your name: _____ SSN: 1 1

Part 1 Employee Business Expenses

Step 1 Enter Your Expenses

1 Vehicle expense from Part 11, line 15 or line 22. 1 1 60.00

2 Parking fees, tolls, and local transportation, including train, bus, etc. 2 1 10.00

3 Travel expense while away from home, including lodging, airplane, car rental, etc. Do not include meals and entertainment. 3 1 10.00

4 Business expenses not included in lines 1 through 3. Do not include meals and entertainment. 4 1 10.00

5 Meals and entertainment expenses. See instructions. 5 1 10.00

6 Add lines 1 through 5 and enter the TOTAL EXPENSES here. 6 1 60.00 10.00

Note: If you were not reimbursed for any expenses in step 1, skip lines 7 through 13 and enter the amount from line 6 on line 14.

Step 2 Figure Any Excess Reimbursements To Report in Income

7 Reimbursements for the expenses listed in step 1 that your employer did not report to you on Form W-2 or Form 1099. 7 1 10.00

Note: If, in both columns, line 8 is more than line 7, skip lines 8 and 9 and go to line 10. You do not have excess reimbursements.

8 Subtract line 6 from line 7. If zero or less, enter zero. 8 1 N/A 10.00

9 Add the amounts on line 8 of both columns and enter the total here. Also add this amount to any amount shown on Form 1040, line 7. This is an EXCESS REIMBURSEMENT reportable as income. 9 1 10.00

Step 3 Figure Fully Deductible Reimbursed Expenses

10 Subtract line 7 from line 6. If zero or less, enter zero. 10 1 N/A 10.00

11 Reimbursements or allowances for the expenses in Step 1 that your employer identified to you, included on Form W-2 or Form 1099, and were not subject to withholding tax. 11 1 10.00

Note: The amount entered on line 11 should also have been reported as income on Form 1040.

12 Enter the smaller of line 10 or line 11. 12 1 10.00

13 Add the amounts on line 12 of both columns. Enter here and on Form 1040, line 23. This is your FULLY DEDUCTIBLE REIMBURSED EXPENSES. 13 1 10.00

Step 4 Figure Expenses To Deduct as an Itemized Deduction on Schedule A (Form 1040)

14 Subtract line 12 from line 10. 14 1 10.00 10.00

Note: If both columns of line 14 are zero, do not complete the rest of Part 1.

15 Enter 20% (20) of line 14, Column B. 15 1 2.00

16 Subtract line 15 from line 14. 16 1 8.00

17 Add the amounts on line 16 of both columns and enter the total here. Also enter the total on Schedule A (Form 1040), line 20. (Qualified Performing Artists and handicapped employees, see instructions.) 17 1 8.00

For Paperwork Reduction Act Notice, see instructions. Page 1 Form 2106 (1987)

TRIGONOMETRY—

(Continued from Page 16)

```

2350 CALL HCHAR(13,6,32)!255
2360 CALL HCHAR(12,7,32)!255
2370 CALL HCHAR(11,8,32)!255
2380 CALL HCHAR(10,9,62)!002
2390 RETURN !136
2400 CALL CHAR(123,"01010202
04040808")!253
2410 CALL CHAR(124,"10102020
4040808")!205
2420 CALL HCHAR(10,9,123)!04
9
2430 CALL HCHAR(11,9,124)!05
1
2440 CALL HCHAR(12,8,123)!05
0
2450 CALL HCHAR(13,8,124)!05
2
2460 CALL HCHAR(14,7,123)!05
1
2470 RETURN !136
2480 CALL VCHAR(10,9,62)!016
2490 CALL VCHAR(11,9,60)!015
2500 CALL VCHAR(12,8,32,2)!1
88
2510 CALL VCHAR(14,7,32)!015
2520 RETURN !136
2530 CALL VCHAR(10,9,126,6)!
244
2540 RETURN !136
2550 CALL VCHAR(10,9,62)!016
2560 CALL VCHAR(11,9,60,4)!1
91
2570 CALL VCHAR(15,9,64)!023
2580 RETURN !136
2590 CALL CHAR(123,"80804040
2020101")!204
2600 CALL CHAR(124,"08080404
02020101")!254
2610 CALL HCHAR(10,10,123)!0
90
2620 CALL HCHAR(11,10,124)!0
92
2630 CALL HCHAR(12,11,123)!0
93
2640 CALL HCHAR(13,11,124)!0
95
2650 CALL HCHAR(14,12,123)!0
96
2660 RETURN !136
2670 CALL HCHAR(10,10,58)!04
8
2680 CALL HCHAR(11,10,32)!04
1
2690 CALL VCHAR(12,11,32,2)!
231
2700 CALL VCHAR(14,12,32)!06
0
2710 RETURN !136
2720 CALL HCHAR(10,10,127)!0
94
2730 CALL HCHAR(11,11,127)!0
96
2740 CALL HCHAR(12,12,127)!0
98
2750 CALL HCHAR(13,13,127)!1
00
2760 RETURN !136
2770 CALL HCHAR(10,10,58)!04
8
2780 CALL HCHAR(11,11,32)!04
2
2790 CALL HCHAR(12,12,32)!04
4
2800 CALL HCHAR(13,13,32)!04
6
2810 RETURN !136
2820 CALL CHAR(123,"00000000
C0300C03")!011
2830 CALL CHAR(124,"C0300C03
")!132
2840 CALL HCHAR(10,10,124)!0
91
2850 CALL HCHAR(10,11,123)!0
91
2860 CALL HCHAR(11,12,124)!0
94
2870 CALL HCHAR(11,13,123)!0
94
2880 CALL HCHAR(12,14,124)!0
97
2890 RETURN !136
2900 CALL HCHAR(10,10,58,2)!
222
2910 CALL HCHAR(11,12,32,2)!
217
2920 CALL HCHAR(12,14,32)!04
6
2930 RETURN !136
2940 C=11 !045
2950 FOR J=1 TO LEN(M$)!242
2960 CALL HCHAR(R,C+J,ASC(S$
C$(M$,J,1)))!236
2970 NEXT J !224
2980 RETURN !136
2990 CALL CLEAR !209
3000 PRINT "TAN(A) = SIN(A)/
COS(A)" !141
3010 PRINT : "COT(A) = COS(A)
/SIN(A)" !069
3020 PRINT : "SEC(A) = 1/COS(
A)" !234
3030 PRINT : "CSC(A) = 1/SIN(
A)" !237
3040 PRINT : : : : !037
3050 REM BY REGENA, 1988 !10
9
3060 END !139

```

Computer maintenance — Part II

Cleaning the console

By GARY COX

The information contained here is accurate to the best of my knowledge and you proceed at your own risk. Also this may void any warranty that you may have on your console.

Before beginning you need to discharge yourself of static electricity so that you do not zap any chips. Touch something grounded, such as the back wall of your PEB. Also be sure to keep track of the screws that you take out in doing the following project. Label the screws if necessary to avoid confusion.

Last month's installment outlined the procedure to use in cleaning cartridges. However, cleaning the cartridge may not be enough to get a malfunctioning console

to perform, and the cartridge port inside the computer must also be cleaned.

Before proceeding with the project, be warned that the first procedure can make your problems worse. If this occurs, then you will be required to disassemble the console. Ultimately, though, this should solve most console lockups unless there is something wrong with the console.

A quick and short way to clean the cartridge port is to bend the end of a pipe cleaner into a half circle. (Do not use anything that has lint or comes apart!) Spray some contact cleaner onto the pipe cleaner (I use TV tuner cleaner from Radio Shack. Whatever you use, be sure it does not harm plastic.) Press the

(See Page 20)

SMALL BUSINESS SOFTWARE.

TI-COUNT For the Texas Instruments Home Computer ... can help you do business a whole new way.

TI-COUNT is a complete professional accounting system for the TI-99/4A. Developed by Pike Creek Software, it is the only system to be recommended and endorsed for the 99/4A by TI. This system has all the features of systems costing up to thousands of dollars and many TEX-COMP customers are already running small to medium size businesses on this system. The TI-COUNT system comes in six separate packages and you only have to purchase those packages you need for your particular application. All packages can be used separately except accounts receivable and accounts payable which require the General Ledger package. Pike Creek completely supports this system and even sample forms are provided that you can have printed locally or purchase from Pike Creek. A background in accounting or bookkeeping is recommended to use this system. Requires 32K Memory Expansion, Disk Drive, Extended Basic, and a printer.

GENERAL LEDGER

Pre-programmed for fast start-up in small businesses. Monitors up to 650 accounts. Operates 5 journals: purchases, sales, receipts, payments, general entries. Updates daily ... provides interim statements ... prints closing adjusted and unadjusted balances, summaries, statements and changes. Uses easy-to-follow familiar debit/credit double entry bookkeeping system.

ACCOUNTS RECEIVABLE

Keeps up to 200 customer ledger accounts on 1 disk ... with ID data, cumulative payment, open invoices. Edits, verifies, prints invoices instantly lists receivables in customer accounts. Produces aging summary, billing statements weekly or monthly. Guides user through every task step-by-clear-step. (Requires General Ledger.)

SPECIAL SAVINGS! ACCOUNTS PAYABLE

Keeps up to 200 vendor ledger accounts on 1 disk ... with ID data, terms of sale, cumulative payment, open invoices. Scans bills for errors, immediately prints and files. User controls automatic check-writing and system: pay by age, code, invoice, or specified amount. Produces vendor file list, check register, copy of purchase journal entry. (Requires General Ledger.)

INVENTORY

Keeps you instantly abreast of sales, returns, purchases, state of stock. Stores up to 700 items in 4 departments on 1 disk ... with ID data, vendor, stock, on-order, back-order, re-order, cost, list and selling price, current value for each item. You select periodic or perpetual report basis. Prints labels, invoice forms, computes sales tax and freight. Operates independently or with General Ledger.

PAYROLL

Automatically provides payroll checks and stubs ... on your choice of weekly, biweekly, semimonthly, monthly basis, plus W-2 forms yearly. Computes 4 withholding taxes per employee ... 8 different deductions for each ... commissions, bonuses, tips, overtime. Keeps up to 100 employee files on 1 disk. Automatically locks for security after payroll is printed. Operates independently or with

MAIL SYSTEM

Change, move, and merge mail files. Add, correct or delete individual names and addresses, sort names and zip codes ... print mailing labels ... with automatic reports for each mail file and disk. System also edits and prints letters, labels, cards. Totals active and inactive names, specified search fields, last names, number of names in each state. Operates independently or with Accounts Payable and Receivable Systems to mail to customers/vendors. NEWLY UPDATED FOR BOTH U.S. AND CANADIAN MAIL SYSTEMS.

*Special
Purchase
Drastic Reductions*



THE ENTIRE TI-COUNT ACCOUNTING PACKAGE AT ONE LOW PRICE \$99.95

THIS PRICE INCLUDES THE ENTIRE SIX PROGRAM SET ALONG WITH THE BONUS PROGRAM AUTO COUNT...

+S&H
entire
package

FREE SUPER BONUS WHEN YOU ORDER THE TI-COUNT PACKAGE AT \$99.95.

AUTO-COUNT TAX LOG Record the date, time, place, purpose, odometer reading and driver for each trip on diskette and then print out any selected data monthly or annually Great for tax records! (a \$50.00 Value)

ACCOUNTING PACKAGES NO LONGER AVAILABLE SEPARATELY!! MAIL SYSTEM ALONE \$19.95

COUNT	TI-COUNT	TI-COUNT
General Ledger	Accounts Payable	Accounts Receivable
Inventory	Payroll	Mail System
Auto-Count Tax Log		

Order today and save!

TEX+COMP

YOUR TEXAS INSTRUMENTS SOURCE

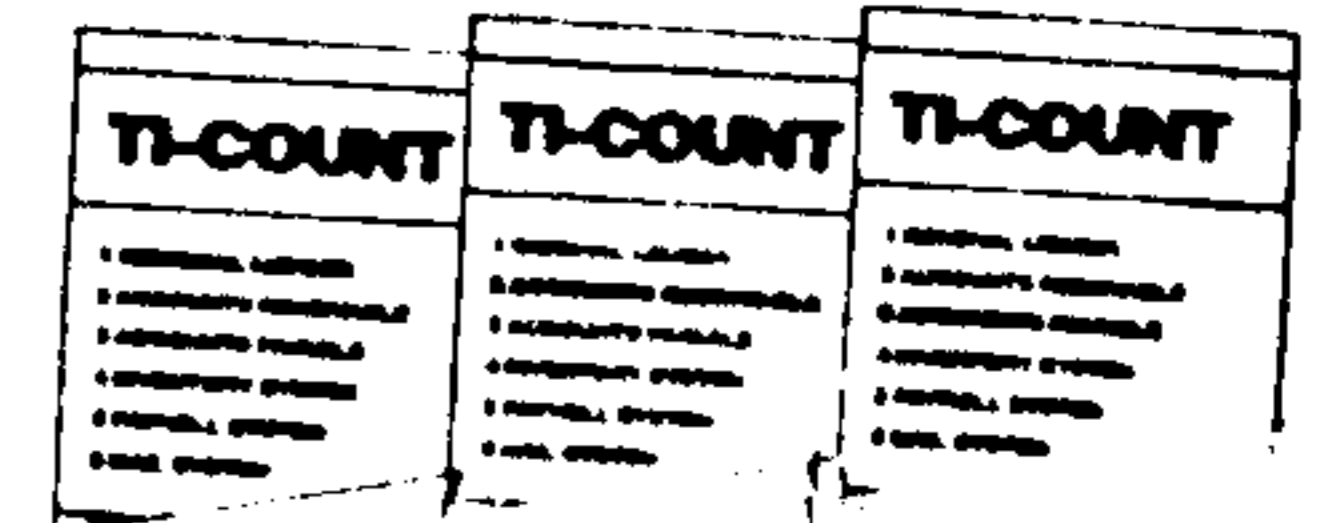

Send order and make checks payable to:
TEX+COMP
P.O. Box 33064, Granada Hills, CA 91344



AUTHORIZED DEALER



VISA and MASTERCARD
HOLDERS CALL DIRECT
(818) 366-6631
24 Hour Order Line

TERMS: All prices FOB Los Angeles. For fastest service use cashiers check or money order. Add 3% shipping and handling (\$3.00 Minimum). East of Mississippi 4 1/2%. Add 3% for credit card orders. Prices and availability subject to change without notice. We reserve the right to limit quantities.

NOTE: Payment in full must accompany all orders—credit card, company check or money order for immediate shipment. Personal checks require up to 4 weeks to clear. California orders add 6 1/2% sales tax.

MAINTENANCE—

(Continued from Page 18)

rounded end into the module port, being careful not to move it to one side or the other. The contacts in the module port are loose, and moving the pipe cleaner in a crosswise motion will bend them! Just place it straight in and pull it straight out. Move it over and do it again until you are across the module port. Do this several times, using a new pipe cleaner if it gets dirty.

When finished, use a dry pipe cleaner to absorb any excess contact cleaner from the module port. Then, wait a while before turning on the computer to make sure that port is dry!

This has either solved your problem or made it worse. If it has made it worse you will have to continue with this article and take apart your console to get directly to the module port. So, if you are leery about taking apart your console you may not want to use the pipe cleaner and just stick to cleaning the cartridges, though cleaning both should be beneficial.

The thing that might make your problem worse when using the pipe cleaner is that the consoles are getting old. Foam rubber was placed inside the module port to dust off cartridge edges when you stick in a cartridge. However, with age this gets brittle and inserting a pipe cleaner may loosen it and cause it to block the contacts. If this occurs, the console will have to be disassembled to remove the foam. What follows are instructions to do just that.

You should note that even without inserting a pipe cleaner, the foam may already be breaking up in your console and blocking the contacts. The inevitable result is that your computer malfunctions. To solve your problem you will need to take the console apart and remove the foam and clean the edge connector.

To do this remove the seven screws in the back of the console. Then pull out the on/off switch (it pops out) and remove the back. With the console up side down (back side up), there are three more screws you should remove the hold the motherboard in place. They are located at middle left and top right of the metal casing which surrounds the motherboard. (Note: Different model consoles may be different.) The metal casing should not be removed.

On the top center of the motherboard is

another screw which you can see through a hole in the metal casing. This must be removed also. Do this carefully as you can easily drop that screw and lose it. If you drop the screw inside of the casing, you need to get it out. Never leave a loose part, especially metal, floating around in the console as it may short out some contacts.

Carefully remove the motherboard, making sure you do not put any stress on wires and do not force anything. It should come up without too much trouble. The internal power supply may give you some trouble in getting the motherboard out. You can take the screws out of it and move it out of the way if you would like to make it easier.

You should now see a black female card edge connector mounted onto a male card edge connector plugged into the motherboard. This small device is what your cartridges plug into. It is called an L-shaped connector, or 90 degree card edge connector. This is the object of your attack. Note the direction it is plugged in (so you can plug it back in the right way later). Pull it out. It should easily snap out. (By the way you can obtain a new card edge connector by calling TI dealer parts and ordering one.

Remove the top of the the L-shaped connector which covers the female connectors. It may not look as if there is anything there to remove but there is. It is held on by some small snap-on clamps. Use your fingers to pry them apart and pull it off. It should come off easily.

The female contacts should be exposed (I didn't realize this was going to be an X-rated article). Again (if you did not clean them before) clean them with the pipe cleaners following the same directions above. On the top, which you removed, is the foam rubber. Take a small knife and remove the foam making sure you get all of it. The foam helps to keep dust out but I have found since it is getting old it is causing more trouble than good and, in my opinion, should be removed. Snap the top back onto the edge connector. Use an eraser to clean the male contacts on the L-shaped connector and wipe it off with a rag.

If you have trouble with your keys double-striking or not responding it may be a dirty keyboard. At this point you may

wish to replace it with a TI99/4A keyboard from Radio Shack, which sells for about \$4. Just unplug your old keyboard from the motherboard and replace it with the Radio Shack TI99/4A keyboard. These Radio Shack keyboards are the original ones placed in TI99/4A's. It does not matter if you have black keys and the Radio Shack keyboard is white.

Now it is time to put it all back together. If you have not done so you may still have to remove the power supply (bottom left circuit board on computer) as it makes it difficult to get the motherboard back in place although, with a little work, I was able to get it back in place without removing it. You can either plug the L-shaped connector onto the motherboard and then place the motherboard into the console housing (best way), or place the L-shaped edge connector into the console housing and place the motherboard on top, making sure it gets plugged into the motherboard. There is a little slot the L-shaped connector drops into on the console housing, so make sure it goes into that slot facing the door of the console housing where modules are inserted.

Replace all of the screws on the motherboard. Be careful on the center screw through the metal housing. Be sure you place the plug that connects your internal console power supply with the outside power supply back in its place at the back of the console before you put the back on the computer.

The preceding procedures should alleviate console lockup problems. Clean your cartridges as well. If you do not want to take apart your cartridges just stick a small eraser down the side of the cartridge inside the door and try to "erase the surface of the contacts and then blow out any eraser junk you may have left in there.

I have done this to both TI99/4A consoles that I own and it has greatly reduced lockup problems. Also, the fact that I have a GRAM Kracker, which is never removed, plugged into my module port also helps. A cartridge expander (Widget) might help also.

Keep your equipment clean, provide protected power (surge protectors on the AC line and phone line) and don't eat or drink around your computer. Treat it with respect and you should have few problems.

NEW P-BOX EXTENSION

OLD SPACE-SAVER CONNECTOR CABLE

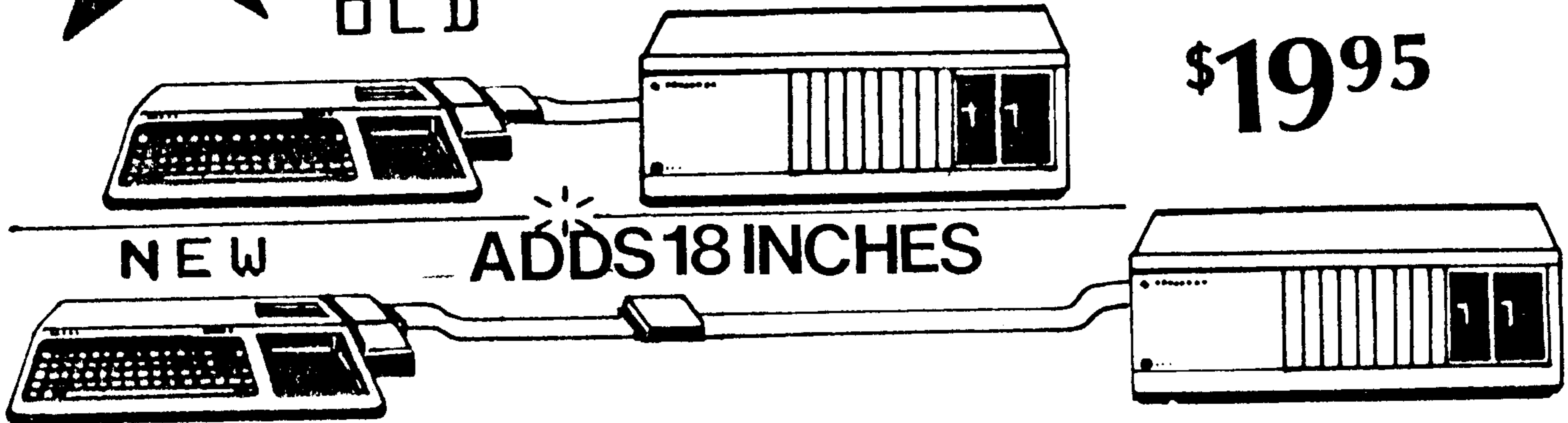

THIS NEW PRODUCT ANSWERS THE NEED MANY TI-99/4A USERS HAVE TO MOVE THE EXPANSION BOX FURTHER FROM THE CONSOLE THAN THE ORIGINAL CABLE PERMITS. IT ALSO MOVES THE HEAVY ORIGINAL TI CONNECTOR AWAY FROM THE CONSOLE WHICH IN TURN ALLOWS MORE FLEXIBILITY. UNLIKE SOME PAST ACCESSORIES OF THIS TYPE, ONLY THE HIGHEST QUALITY CONNECTORS AND TWISTED PAIR FLEX CABLE IS USED FOR RELIABLE PERFORMANCE AND LOW LOSS. THIS 18" EXTENSION CABLE ALSO LETS YOU MOVE YOUR COR COMP 9900 SYSTEM 18" AWAY FROM THE CONSOLE. GREAT FOR TIGHT QUARTERS OR TO GAIN MORE SPACE NEXT TO THE CONSOLE.....\$19.95 +s&h

Now get more out of your TI Home Computer — for less.

ADD A 2ND DISK DRIVE TO YOUR TI/99/4A SYSTEM

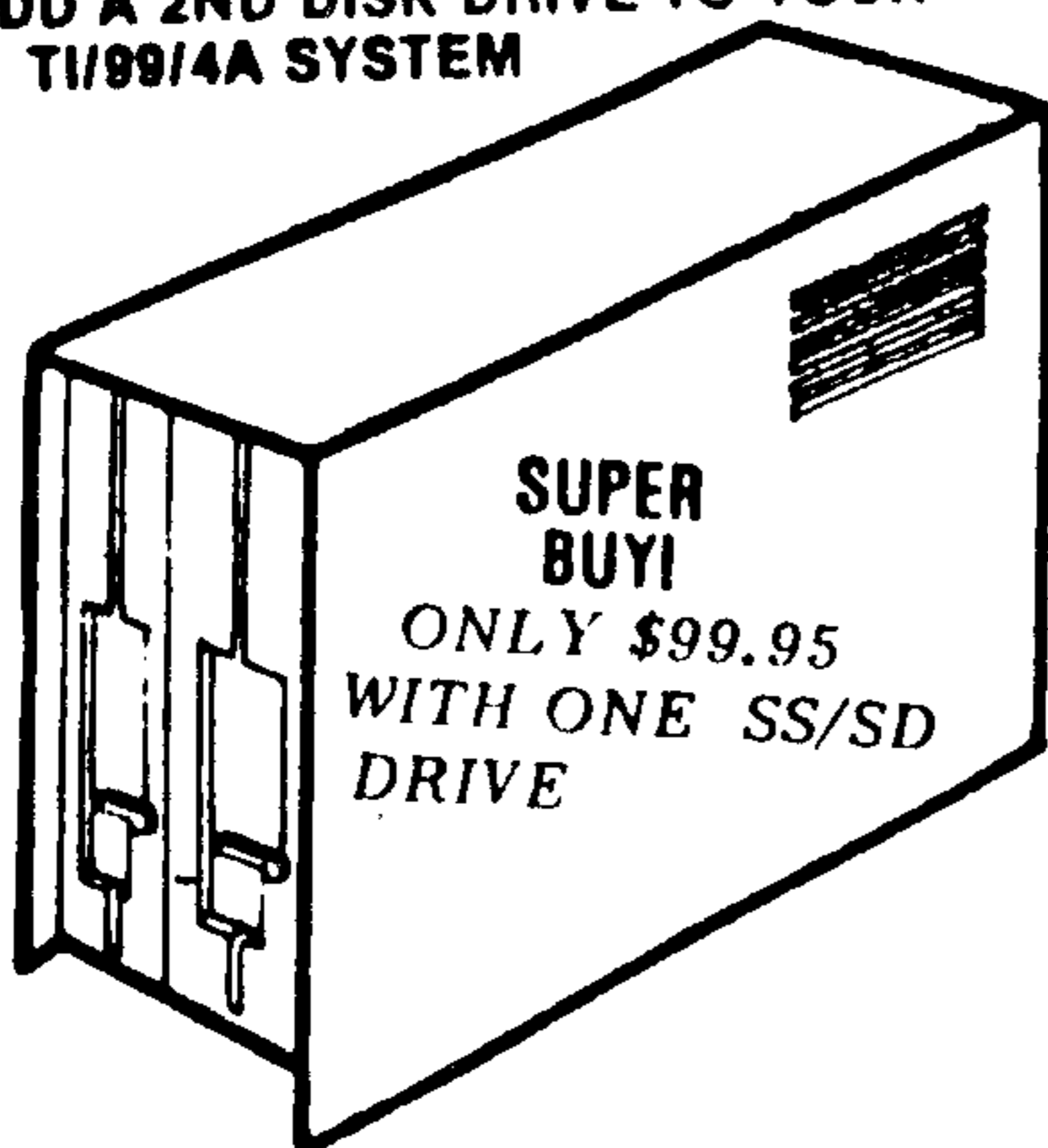

Stand Alone Disk Drive

A Must Addition For Your System!

TEX-COMP BREAKS THE PRICE BARRIER ON DISK DRIVES FOR THE TI-99/4A

We made a special purchase and as always we pass our savings right on to you. NEW LOWER PRICES on all drives and stand alone drive units...Full height, half height, single and double sided and density. TI controller cards will work with single or double sided drives/single density. For double sided/double density you need the Cor-Comp controller card.

NEW LOWER PRICES!!!

- Stand alone ss/sd drive (in case with power supply and cable). \$ 99.95
- Stand alone ds/dd drive (in case with power supply and cable). \$119.95
- Half height ds/dd drives (2 will fit in P-Box.....) \$ 89.95.
- Order 2 drives and receive P-Box installation kit with all cables, bracket, screw and instructions (reg. \$29.95) for only\$ 9.95.
- Stand alone drive case with heavy duty power supply for one full size or two half height drives.....\$ 39.95.
- Specify TI P-Box or Cor Comp 9900 system when ordering stand alone drives so we can provide correct cable and instructions!
- SPECIAL original TI-99/4A ss/sd drives NEW only \$59.95..add \$20 for ds/dd.

These units are sold with a 90-day warranty.

Cor Comp ds/dd controller card for P-Box-supports 4 drives....\$149.95

VOLKSMODEM The Complete Low-Cost Plug-In Modem.

It puts computer-to-computer communications within easy reach of every personal computer owner.

Just plug Volksmodem between any wall phone jack and telephone and put your computer into instant communication with thousands of others. It's that easy. No extra parts or tools are necessary—just one adapter cable and software is all that's needed.

MONEY SAVING SPECIAL. Get the Volksmodem (reg. \$59.95), 99/4A modem cable (reg. \$12.95), and Terminal Emulator II (reg. \$9.95) an \$80+ value for ONLY \$39.95.

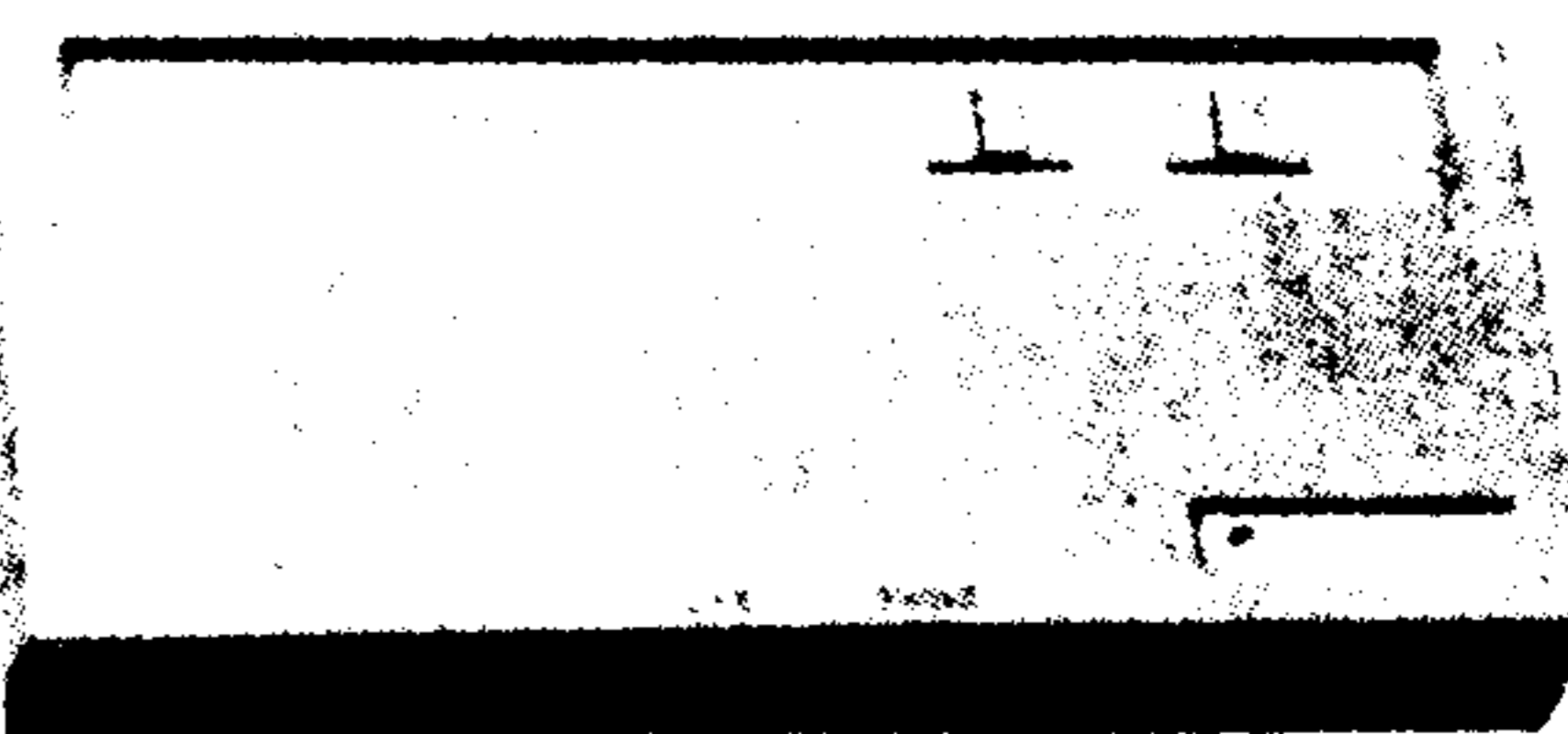

Send order and make checks payable to

TEX+COMP

PO BOX 33064 - GRANADA HILLS CA 91344



AUTHORIZED DEALER



VISA and MASTERCARD
HOLDERS CALL DIRECT
(818) 366-6631
24 Hour Order Line

TERMS: All prices FOB Los Angeles. For fastest service use cashiers check or money order. Add 3% shipping and handling (\$3.00 Minimum). East of Mississippi 4 1/2%. Add 3% for Credit Card orders. Prices and availability subject to change without notice. We reserve the right to limit quantities.

NOTE: Payment in full must accompany all orders. Credit card. Company check or Money order for immediate shipment. Personal Checks require up to 4 weeks to clear. California orders add 6 1/2% sales tax.

Nut-z

An Extended BASIC game to drive you crazy

By DAVID MENNENOH

Nut-Z is a dynamic board game in which the object is to change the tops of the cubes in the maze to a new color by jumping on them. It is similar to Q*Bert. When Nut-Z lands on an unchanged cube its surface changes to a new color and Nut-Z is awarded points. Though this may seem to be a relatively easy task, Nut-Z must be careful to avoid being struck by one of the ever menacing poison arrows.

Playing the game is simple as Nut-Z is controlled via four keys. The default keys are:

- Up and right — E
- Up and left — W
- Down and right — K
- Down and left — J

The control keys may be redefined by the player.

When a maze is cleared, a new maze is presented and Nut-Z must continue his quest. There are ten mazes to each level. When a new level is reached, the board designs are repeated but the arrows fly faster.

At the beginning, you are given five men and may gain a new man by clearing a level.

Points are awarded according to the level you are on. On level 1 an unchanged cube is worth 50 points. Level 2 is 100 points. Level 3 is 150 points. And so on. Each time a new maze is cleared the player is awarded 1000 bonus points.

The program runs out of Extended BASIC. Only a console is required. It is fully compatible with the Geneve. About 6K of console memory remains free, permitting plenty of room for modification. For example, the user may want to change the number of mazes in a level. Doing this is relatively easy. The program uses the color of the mazes to determine the levels. In each level, COLOR 7 represents the first maze and COLOR 9 represents the last maze. The first maze resides in lines 920 and 930 and the last maze resides in lines 1120 and 1130. So, unless you wish to change the first or last mazes, just put your maze data in between lines 930 and 1120 and keep your maze color something other than 7 or 9.

The maze data is entered as coordinates that represent the center of each cube. The row coordinates should be 4 rows apart while the columns should be 2 apart. Follow the coordinate set with a zero, which signals that there are no more cubes in the maze. Follow this with the number of cubes in the maze and, finally, the color for the tops of the newly changes cubes.

Here is a sample maze:

```
DATA 3,4,3,28,7,6,7,26,11,8,11,24,1
5,10,15,22,19,12,19,20,15,14,15,1
8,11,16,7,14,7,18,3,16,3,12,3,20,3,8,
3,24
```

```
DATA 0,20,14
```

Always make sure that the coordinates 3,16 are in the maze data as this is where the program places Nut-Z at the start of each new maze.

There are many other things that may easily be changed that could make this a better game. Incidentally, the highest score yet attained is 84,250. Good luck!

This program has been processed using Checksums. The numbers that appear after exclamation marks should not be entered.—Ed.

PROGRAM EXPLANATION

Line	No.Explanation
10-70	Title screen
80-280	Check if user wants to redefine keys
290-300	Set up game variables
310	Error control
320-370	Character definitions
380	Set colors
390-480	Read board data, build board
490	Character colors
500-520	Set up status display at bottom of screen
530-560	Put on the sprites
570-620	Check for keypress and set jumping motions
630-650	Move Nut-Z
660-710	See where Nut-Z landed, award points
720-740	Board cleared, get a new one
750	Check for collision
760-810	Die routine
820-910	Game over, display scores, board and level
920-1130	Board data

NUT-Z

```
10 CALL CLEAR :: CALL SCREEN 034
(2):: FOR T=1 TO 13 :: CALL
COLOR(T,16,2):: NEXT T !009
20 CALL CHAR(33,"000000FFFF0
00000",34,"E01804FFFF0418E0"
,35,"249249FFFF499224")!019
30 CALL COLOR(1,5,2,13,7,16)
:: CALL CHAR(128,"00003C3C3C
3C0000"):: CALL HCHAR(5,3,12
8,27)!080
40 CALL HCHAR(19,3,128,27)::
CALL VCHAR(5,3,128,14):: CA
LL VCHAR(5,30,128,15)!059
50 DISPLAY AT(9,11)SIZE(9):"
N U T - Z" :: DISPLAY AT(14,
3)SIZE(24):"PRESS SPACE BAR
TO BEGIN" !142
60 CALL KEY(5,K,S):: IF K=32
THEN 80 !199
70 RANDOMIZE :: F=INT(16*RND
)+1 :: B=INT(16*RND)+1 :: CA
LL COLOR(13,F,B):: GOTO 60 !
```

```
80 CALL CLEAR :: CALL CHARGE
T :: CALL MAGNIFY(1)!041
90 FOR T=1 TO 8 :: CALL COLO
R(T,16,6):: NEXT T :: CALL S
CREEN(6)!145
100 DISPLAY AT(10,3):"UP & R
IGHT= E" :: DISPLAY AT(11,
3):"UP & LEFT= W" !000
110 DISPLAY AT(12,3):"DOWN &
RIGHT= K" :: DISPLAY AT(13,
3):"DOWN & LEFT= J" !163
120 DISPLAY AT(16,6):"REDEFI
NE KEYS (Y/N)" !086
130 CALL KEY(5,K,S):: IF S=0
THEN 130 !203
140 IF K=78 THEN 290 !098
150 IF K=89 THEN 170 !235
160 GOTO 130 !209
170 DISPLAY AT(16,1):"" :: F
OR T=1 TO 4 !033
```

(See Page 24)

CERTIFICATE '99!^{T.M.}

THE ULTIMATE CERTIFICATE-POSTER MAKER

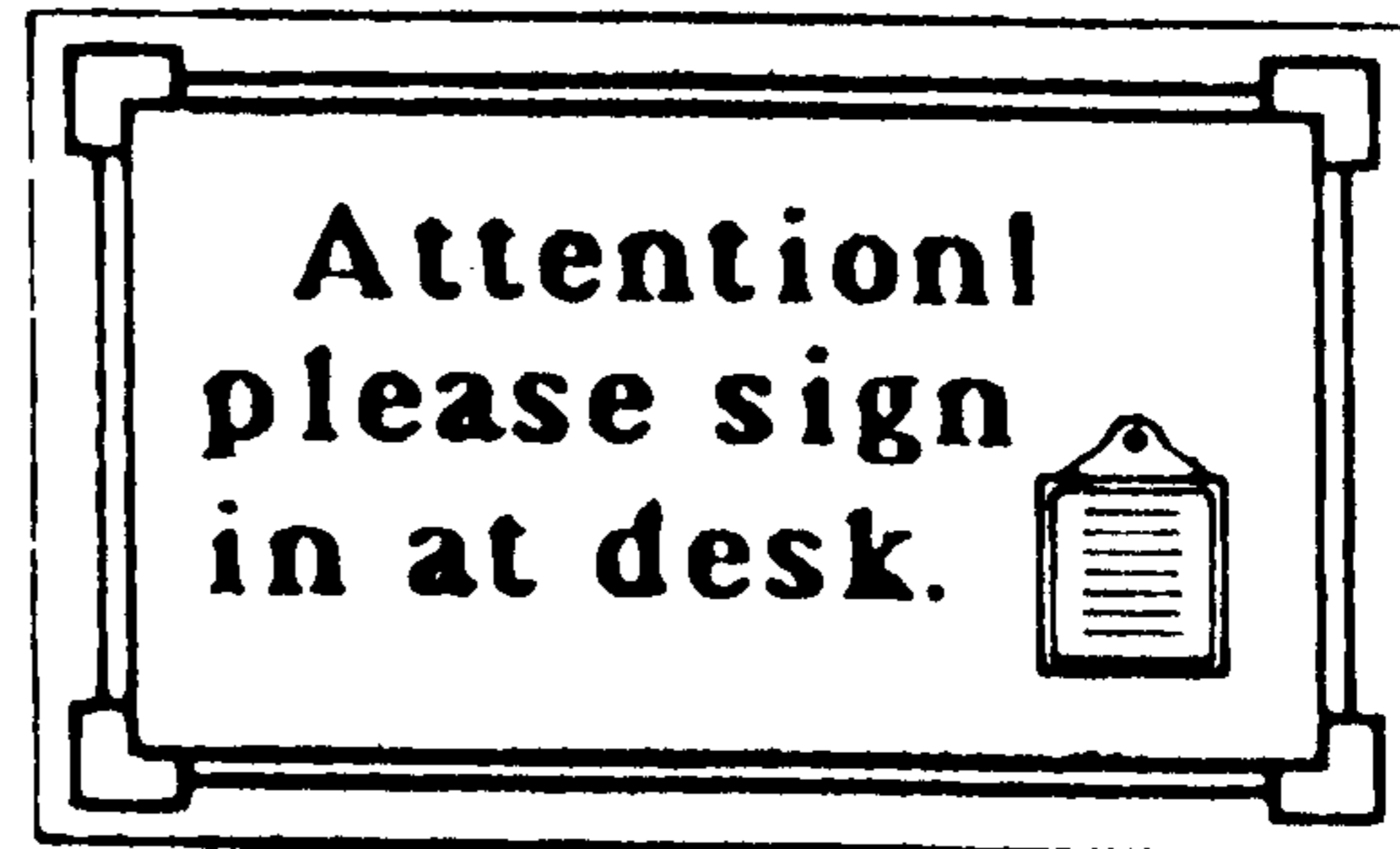

CREATE CERTIFICATES, AWARDS, DIPLOMAS & LICENSES FOR YOUR SCHOOL CLUB OR BUSINESS!

PRINT ADVERTISEMENTS, SIGNS AND NOTICES.....

EASILY MAKE FLYERS FOR THAT UP-COMING EVENT

CONGRADULATE AN OUTSTANDING ACHIEVER.

THIS ALL NEW PROGRAM DOES IT, ALL...CREATE CERTIFICATES, ADVERTISEMENTS, DIPLOMAS, HANDBILLS, INVATATIONS, AND SIGNS. THIS DISK BASED PROGRAM IS SELF CONTAINED WITH A CHOICE OF BORDERS, TYPE STYLES, GRAPHICS, AND EVEN SIGNATURES, PARCHMENT PAPER AND GOLD FOIL SEALS ARE INCLUDED.

USE WITH ANY EPSON/STAR DOT MATRIX PRINTER, 32K, AND EX-BASIC **\$19⁹⁵** S&H

*DEVELOPED EXCLUSIVELY FOR TEX.COMP BY GREAT LAKES SOFTWARE

ONLY **\$19⁹⁵** Plus S&H **THE PRINTSHOPPE 99™ Desktop Publishing System** featuring **GRAPHX + with Flip & Rotate, & Quick Load**



GRAPHX+ is the ultimate graphics program for the TI-99/4A. Not only does it have the features you need for newsletters, letterheads, labels, and even T-shirt printing, but it is fully supported with a whole series of clipart and font sets with more to come. Loads on extended basic with 32K memory. Comes with a large manual with all features explained. Epson compatibility.

GRAPHX+ WITH 2 BONUS DISKS OF CLIPART & FONTS..\$19.95 +s&h

ACCESSORIES: Asgard Software nas developed a set of 4 GRAPHX Companion Disks containing great clipart and font sets. Only \$7.95 ea or the entire set of 4 disks (7disk sides) only \$24.95 when purchased together. Publish Like A Pro!!!



Send order and make checks payable to:

TEX+COMP

PO Box 33064, Granada Hills, CA 91344



AUTHORIZED DEALER



VISA and MASTERCARD HOLDERS CALL DIRECT
(818) 366-6631

TERMS: All prices FOB Los Angeles. For fastest service use cashiers check or money order. Add 3% shipping and handling (\$3.00 Minimum) East of Mississippi 4 1/2%. Add 3% for credit card orders. Prices and availability subject to change without notice.

Personal checks require up to 4 weeks to clear. 24 Hour Order Line
California orders add 8 1/2% sales tax.

NUT-Z—

(Continued from Page 22)

```

180 ACCEPT AT(9+T,17)SIZE(1)
:K$(T)!052
190 IF K$(T)="" THEN 180 !10
2
200 KEE(T)=ASC(K$(T)):: NEXT
T !057
210 IF KEE(1)=KEE(2)OR KEE(1)
)=KEE(3)OR KEE(1)=KEE(4)THEN
170 !195
220 IF KEE(2)=KEE(3)OR KEE(2)
)=KEE(4)THEN 170 !212
230 IF KEE(3)=KEE(4)THEN 170
!226
240 DISPLAY AT(16,6):"KEYS O
K (Y/N)" !168
250 CALL KEY(5,K,S):: IF S=0
THEN 250 :: IF K=78 THEN 17
0 !174
260 IF K=89 THEN 280 !090
270 GOTO 240 !063
280 GOTO 300 !124
290 KEE(1)=69 :: KEE(2)=87 :
: KEE(3)=75 :: KEE(4)=74 !08
1
300 ME=4 :: POI=0 :: PL=0 ::
COLO=7 :: MO1=1 :: MO2=2 ::
MO3=4 :: MO5=5 :: LEV=0 ::
BOR=1 !024
310 ON ERROR 760 !003
320 CALL CLEAR :: CALL CHARS
ET :: FOR T=3 TO 8 :: CALL C
OLOR(T,16,5):: NEXT T :: CAL
L SCREEN(5)!220
330 CALL CHAR(94,"0103070F1F
3F7FFF",95,"80C0E0F0F8FCFF"
",136,"FF7F3F1F0F070301",137
,"FFFFFFCF8F0E0C080")!107
340 CALL CHAR(99,"3E4595897R
204040")!032
350 CALL CHAR(33,"FFFFFFFF
FFFFFF",40,"FFFFFFFFFFFFFF"
",34,"0103070F1F3F7FFF",35,"
80C0E0F0F8FCFF")!052
360 CALL CHAR(125,"FF7F3F1F0
F070301",126,"FFFFFFCF8F0E0C0
80",42,"FF7F3F1F0F070301",41
,"FFFFFFCF8F0E0C080")!087
370 CALL CHAR(92,"FFFFFFFF
FFFFFF",93,"183C5AFF7E3C183C
",96,"00002041FF412000",97,"
000482FF82040000")!167
380 CALL COLOR(1,16,5,2,15,5
,12,16,15,8,COLO,5,14,COLO,1
5)!184
390 REM BUILD MAZE !043
400 READ R,C !223
410 IF R<>0 THEN 450 !138
420 IF R=0 THEN SQ=C :: READ
COLO !040
430 IF COLO=9 THEN RESTORE :
: GOTO 490 !113
440 IF COLO=7 THEN MO1=MO1+2
:: MO2=MO2+2 :: MO3=MO3+2 :
: MO4=MO4+2 :: GOTO 490 ELSE
GOTO 490 !120
450 CALL HCHAR(R,C,33):: CAL
L HCHAR(R,C+1,33):: CALL HCH
AR(R,C-1,33):: CALL HCHAR(R-
1,C,33):: CALL HCHAR(R+1,C,3
3)!254
460 CALL HCHAR(R-1,C+1,35)::
CALL HCHAR(R-1,C-1,34):: CA
LL HCHAR(R+1,C-1,125):: CALL
HCHAR(R+1,C+1,126)!108
470 CALL HCHAR(R+2,C,40):: C
ALL HCHAR(R+2,C-1,42):: CALL
HCHAR(R+2,C+1,41)!228
480 GOTO 400 !224
490 CALL COLOR(1,16,5,2,15,5
,12,16,15,8,COLO,5,14,COLO,1
5)!184
500 IF COLO=7 THEN BOR=1 ::
LEV=LEV+1 :: ME=ME+1 :: DISP
LAY AT(24,3)SIZE(6):"MEN=";M
E :: DISPLAY AT(23,3):"LEVEL
=";LEV !109
510 DISPLAY AT(24,15):"POINT
S=";POI :: DISPLAY AT(23,15)
:"BOARD=";BOR !156
520 DISPLAY AT(24,3)SIZE(6):
"MEN=";ME :: DISPLAY AT(23,3
)SIZE(10):"LEVEL=";LEV !204
530 CALL SPRITE(#2,97,2,17,2
00,0,MO1,#3,96,2,33,200,0,-M
O2,#4,97,2,49,200,0,MO2,#5,9
6,2,65,200,0,-MO3)!042
540 R=3 :: C=16 :: CALL SPRI
TE(#1,93,2,R*8-7,C*8-7,#6,97
,2,81,200,0,MO4,#7,96,2,97,2
00,0,-MO1)!042
550 CALL SPRITE(#8,97,2,113,
200,0,MO3,#9,96,2,129,200,0,
-MO4,#10,97,2,145,200,0,MO1)
!202
560 CALL DELSPRITE(#11)!176
570 CALL KEY(5,K,S):: CALL P
EEK(-31877,BV):: IF BV AND 3
2 THEN 760 ELSE IF S=0 THEN
570 !224
580 IF K=KEE(4)THEN M1=37 ::
J=35 :: M2=-20 :: R=R+4 ::
C=C-2 :: GOTO 630 !195
590 IF K=KEE(1)THEN M1=-36 :
: J=-38 :: M2=20 :: R=R-4 ::
C=C+2 :: GOTO 630 !132
600 IF K=KEE(3)THEN M1=37 ::
J=35 :: M2=20 :: R=R+4 :: C
=C+2 :: GOTO 630 !255
610 IF K=KEE(2)THEN M1=-36 :
: J=-38 :: M2=-20 :: R=R-4 :
: C=C-2 :: GOTO 630 !072620
GOTO 570 !139
630 FOR T=J TO M1 :: CALL MO
TION(#1,T,M2):: CALL PEEK(-3
1877,BV):: GOSUB 750 :: NEXT
T :: CALL MOTION(#1,0,0)!13
3
640 CALL SOUND(10,110+(R*40)
,1)!185
650 CALL LOCATE(#1,R*8-7,C*8
-7):: CALL GCHAR(R,C,CH)!210
660 IF CH=33 OR CH=92 THEN 6
70 ELSE GOTO 760 !024
670 IF CH=33 THEN CALL HCHAR
(R,C,92):: CALL HCHAR(R+1,C,
92):: CALL HCHAR(R-1,C,92)::
CALL HCHAR(R,C-1,92):: CALL
HCHAR(R,C+1,92)!196
680 IF CH=33 THEN CALL HCHAR
(R-1,C-1,94):: CALL HCHAR(R-
1,C+1,95):: CALL HCHAR(R+1,C
-1,136):: CALL HCHAR(R+1,C+1
,137)!041
690 IF CH=33 THEN PL=PL+1 ::
IF PL=SQ THEN 720 !173
700 IF CH=33 THEN POI=POI+(5
0*LEV):: DISPLAY AT(24,22):P
OI !113
710 GOTO 570 !139
720 POI=POI+1000 :: DISPLAY
AT(24,15):"POINTS=";POI !169
730 CALL SOUND(100,800,1,770
,1,600,1)!009
740 CALL CLEAR :: PL=0 :: BO
R=BOR+1 :: CALL DELSPRITE(AL
L):: GOTO 390 !180
750 IF VB AND 32 THEN 760 ::
RETURN !131
760 J=1 :: CALL MOTION(#1,0,
0):: FOR T=450 TO 400 STEP -
1 :: CALL SOUND(50,T,J):: J=
J+.50 :: NEXT T :: CALL SOUN
D(100,110,1,-5,1,110,5)!211
770 ON ERROR 790 !034
780 CALL POSITION(#1,M,N)::
CALL SPRITE(#11,99,16,M-8,N+
(See Page 26)

```

TEX+COMP
proudly presents

a great deal

AUTHORIZED
DEALER

ON A
**COMPLETE COMPUTER
SYSTEM**

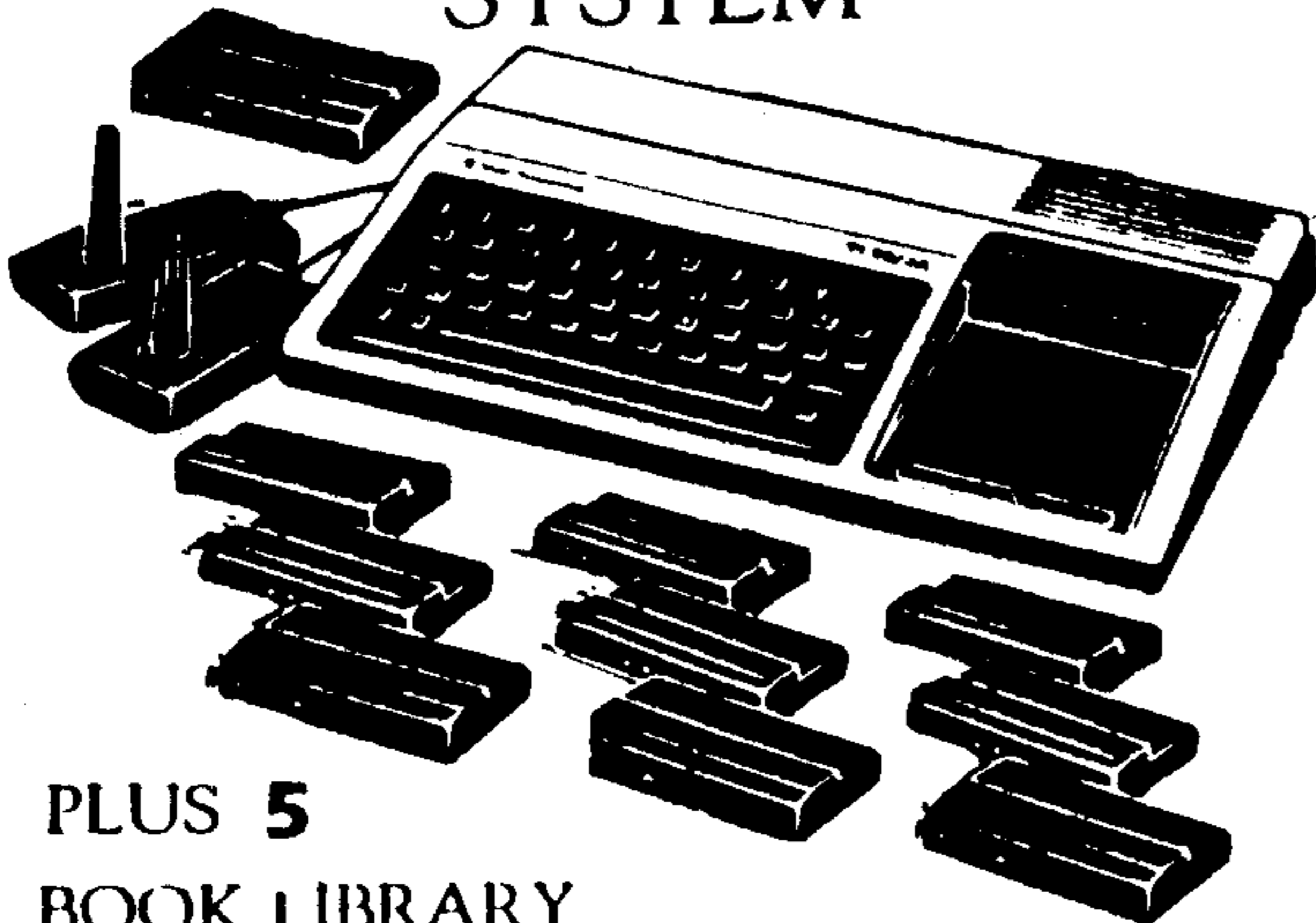

**PLUS 5
BOOK LIBRARY**

TO START CHILDREN OF ANY AGE



**THE PERFECT
FAMILY
GIFT**

TEX+COMP™

**AMERICA'S NUMBER ONE
TI COMPUTER RETAILER**



Charge-it On Your
Visa or MasterCard
**ORDER BY PHONE
24 HOURS A DAY**

7 Days a Week!

(818) 366-6631

P.O. Box 33084, Granada Hills, CA 91344

TERMS: All prices F.O.B. Los Angeles. For fastest service send cashiers check or money order. Personal checks require up to 15 days to clear. Prices reflect a 3% discount for cash or approved check. Add 3% for Credit Card orders. Prices and availability are subject to change without notice. We reserve the right to limit quantities. California orders add 6.5% sales tax.

Tex Comp, the world's largest retailer of Texas Instruments home computer products invites you and your family to join the millions of families who are already using the TI-99/4A, the most powerful and versatile home computer ever produced. There are over 1000 programs now available for the TI-99/4A including education, family financing, arcade games, word processing, data base management, and the list goes on and on. New software & accessories are being continuously introduced. Tex Comp and Texas Instruments have put together this offer to provide your family with the opportunity to get started with a **real quality computer** instead of an underpowered game playing toy.

**YOU RECEIVE
THE FOLLOWING**

1. TI-99/4A Deluxe Black & Silver Computer complete with TV adaptor, power supply, users manual, programming manual and 1 year TI warranty.
2. One pair of TI Joysticks
3. 4-Volume set of Datamost books for the TI-99/4A: Kids & TI, Computer Playground TI, Elementary TI & Games TI's Play
4. Best selling book "Programs for the TI Home Computer" by Davis
5. 10 Most Popular TI Software Modules: Early Learning Fun, Physical Fitness, Amazing, Hangman, TI Invaders, Blasto, Munchman, The Attack, Tombstone City, and Home Financial Decisions
6. Cassette recorder interface cable
7. Tex-Comp TI-99/4A Catalog & Order Kit
8. \$50 Savings Certificate on future orders Purchase up to \$100 from a large selection of TI Software, Accessories and Books at 1/2 the regular price.

ALL FOR ONLY

Your Cost

\$99.95

*Shipping, handling & insurance on this special offer is \$10.00 (Continental U.S.) to any UPS deliverable address. HI, AK, Canada and APO slightly higher.

Complete with a \$50 Savings Certificate for use on future purchases.

Whether you're a beginner or a "pro", the TI Home Computer will give you more for your money.

Everything about the TI Home Computer is designed to make it easy to use. So it's the easiest to start with, and stay with. For the whole family.

NUT-Z—

(Continued from Page 24)

```

8):: CALL SOUND(100,-1,1)::
CALL SOUND(100,-8,1)!181
790 ME=ME-1 :: IF ME<1 THEN
820 !159
800 DISPLAY AT(24,3)SIZE(6):
"ME=";ME !024
810 ON ERROR 760 :: GOTO 530
!232
820 CALL CLEAR :: CALL CHARS
ET :: CALL SCREEN(5):: FOR T
=3 TO 8 :: CALL COLOR(T,16,5
):: NEXT T :: CALL DELSPRITE
(ALL):: DISPLAY AT(10,7):"G
A M E O V E R" !018
830 DISPLAY AT(2,11):"MADE I
T TO" :: DISPLAY AT(4,4):"LE
VEL ";LE V :: DISPLAY AT( 4,
17):"BOARD ";BOR !221
840 DISPLAY AT(15,8):"SCORE="
";POI !186
850 IF POI>HS THEN HS=POI !1
84
860 DISPLAY AT(17,6):"HIGH S
CORE=";HS !178
870 DISPLAY AT(24,11):"PLAY
AGAIN" !074
880 CALL KEY(5,K,S):: IF S=0
THEN 880 !188
890 IF K=89 THEN RESTORE ::
GOTO 90 !055
900 IF K=78 THEN CALL CLEAR
:: CALL SOUND(100,600,1,610,
1,620,1):: CALL SOUND(100,70
0,1,770,1,800,1):: END !100
910 GOTO 880 !194
920 DATA 3,16,7,14,7,18,11,1
2,11,16,11,20,15,10,15,14,15
,18,15,22,19,8,19,12,19,16,1
9,20,19,24 !177
930 DATA 0,15,7 !034
940 DATA 3,16,7,18,11,20,15,
18,19,16,15,14,11,12,7,14,3,
12,3,20,19,20,19,12 !033950
DATA 15,10,19,8,7,10,3,8,7,2
2,3,24,15,22,19,24,0,20,13 !
080
960 DATA 3,16,7,14,7,18,11,1
2,11,20,15,10,15,14,15,18,15
,22,15,26,19,8,19,16,19,24 !
041
970 DATA 15,6,15,26,11,4,11,
28,7,2,7,30,0,18,14 !250
980 DATA 3,8,3,16,3,24,7,6,7
,10,7,14,7,18,7,22,7,26,11,1
2,11,16,11,20,15,10,15,22 !1
25
990 DATA 19,8,19,12,19,20,19
,24,0,18,11 !067
1000 DATA 3,16,15,14,15,18,1
9,12,19,20,19,8,19,24,15,6,1
5,26,11,8,11,24,7,10,7,22 !2
02
1010 DATA 3,12,3,20,7,14,7,1
8,11,16,19,16,0,19,4 !252
1020 DATA 3,8,3,12,3,16,3,20
,3,24,7,10,7,14,7,18,7,22,11
,8,11,12,11,20,11,24,15,6,15
,14 !004
1030 DATA 15,18,15,26,19,8,1
9,16,19,24,0,20,10 !010
1040 DATA 3,8,3,12,3,16,3,20
,3,24,7,10,7,14,7,18,7,22,11
,12,11,16,11,20,15,14,15,18,
19,16 !113
1050 DATA 0,15,3 !030
1060 DATA 3,4,3,8,3,12,3,16,
3,20,3,24,3,28,7,6,7,14,7,18
,7,26,11,4,11,8,11,12,11,20,
11,24,11,28 !204
1070 DATA 15,6,15,10,15,14,1
5,18,15,22,15,26,19,8,19,12,
19,16,19,20,19,24 !013
1080 DATA 0,28,14 !085
1090 DATA 3,16,7,14,7,18,11,
12,11,16,11,20,15,10,15,14,1
5,18,15,22,19,24,19,20,19,16
!079
1100 DATA 19,12,19,8,15,6,15
,26,11,4,11,28,7,6,7,26,3,8,
3,24 !230
1110 DATA 0,23,11 !077
1120 DATA 3,4,3,12,3,16,3,20
,3,28,7,6,7,10,7,14,7,18,7,2
2,7,26,11,4,11,8,11,24,11,28
,15,6,15,10 !213
1130 DATA 15,14,15,18,15,22,
15,26,19,4,19,12,19,20,19,28
,0,25,9 !049

```

Printing multiple columns

This is the continuation of an article begun in the January 1988 issue.—Ed.

By WILLIAM R. BROWN
 FORMATTING DATA FILES

Multicol can use files produced through the Editor SF and the Formatter print to disk file. Files outputted by the Editor Print File option, the Editor/Assembler or by a BASIC program will not work with this program. However, if these files are resaved by the Editor SF function then they will work.

All files must have as their first line of text the number of lines in the file and nothing else. The remainder of the line is left blank. The next lines can have the Formatter instruction codes if the file is to be run through the Formatter, otherwise the text can begin on the second line.

At this point the decision as to what mat-

ter of output is needed. First is how many columns are to be used. Next, which style of print is to be used. There are two choices of column mode and three choices of print mode. This makes six combinations. Each combination has to have its own line length in order to print properly. Finally, when starting to create a file you should set the Tab so that you will get automatic word wrap thus keeping the length of lines within the acceptable limits for which ever mode is to be used. The recommended Tab settings for the various mode combinations are as follows:

No.Col.	Style	Tab Set
2	Pica	34
3	Pica	22
2	Elite	42
3	Elite	27
2	Condensed	62

3 Condensed 39

The maximum number of lines to a page is 66. However, to allow for pagination and bottom of page margin it is recommended that a maximum of 58 lines be used. For the two-column mode use 116 lines and for the three-column mode use a maximum of 174 lines.

If the number of lines does not come out to an even division then add blank lines at the end of your text to accomplish this. This is very important because the program works by dividing the total number of lines by either two or three depending on which column mode is used. If the total number is not evenly divided then a line of text will be dropped.

An important point to remember in line number totals is that if there are fewer ac-

(See Page 27)

MULTICOL—

(Continued from Page 26)

tual lines than that listed on line 1 you will get an error message that the "FILE CANNOT BE FOUND." However, if there are more lines than listed in line 1, the program will work but it will only print as many lines as the number listed in line 1.

Another item that is critical is the number of characters in a line. Remember that in TI-Writer the first number in the Tab settings or in the Formatter margin settings is zero, not 1. Therefore, the Tab or margin setting must be one less than the number of characters you want to use. If there are more characters in a line than what the print/column mode can handle then the printouts will be garbaged up. There can be less characters but not more to a line. Should you want to print a file that has been set up, say, for two column condensed print, in the three column or in Elite or Pica print style, then you will have to reenter the file in the Editor and reformat it for the correct line length and number of lines.

This actually is not as complicated as it may seem. The system that I use is to put a left bracket ([]) carriage return at the end of all short lines or lines with spaces in them, all blank lines have a left bracket and only the line at the end of paragraphs have a left bracket. Thus, all I have to do to adjust from one format to another is to insert a character (FCTN 2) at the beginning of each paragraph and reformat (CNTL 2).

After all paragraphs have been reformatted to the new line widths, your file is ready to print in the new mode. You'll need to do this only rarely, if ever.

Another of the options available is the use of files saved in various ways. You can use the file which is entered in the Editor that has left bracket carriage returns. Option C is used here. If the file has been saved through the Formatter then use Option L. Also, if the file has been stripped of all control characters then use Option N.

The C Option, which contains the left bracket carriage return codes, has a disadvantage. You must delete the left bracket after the number of lines in the first line and remove the left bracket from any blank lines. Other than that, this option works well. The L Option works without any difficulty. I use this the most as it gives me

Right Margin justification. However, this option also needs to be edited. When the Formatter uses the control codes it leaves a left bracket in its place. The Formatter automatically provides for a three-line page header. Thus, the first three lines of the file end up being left brackets before the line with the number of lines in the file. These first three lines must be deleted because the program provides for its own page header.

The Formatter has a tendency to add blank lines. The default for page length is for 66 lines so that if you do not spell it out, a bottom of page margin, a new page code and three more blank lines for a new page header are added at line 63.

The last Option N, is used when a file has been saved by the Editor Print File C mode. This strips all control characters from the file. However, the program will not use this file unless it has been reentered into the Editor and saved by the Editor SF option. This method has its uses but for the most part I do not use it often.

The next option available is one that provides a larger left margin when you print on the front side and a larger right margin on the backside of the page. You can print on both sides of the sheet of paper and have a matching wide margin for binding the sheets or for hole punching use in loose leaf binders.

You also have the option of pagination, should you wish to have your pages numbered, and also which Disk Drive you may wish to have your data file in.

The final option occurs after the pro-

gram has printed out the file. This option clears out the stack so that you can begin another file through the program or reprint the first file again.

USING PRINTER CONTROL CODES

The CONTROL U printer control codes can be used with this program provided you add additional code to adjust for the spaces used by the control codes. The printer reads the control codes and then shifts the text to the left the number of spaces that were occupied by the codes. This results in the shifting the adjoining columns as well thus throwing off the column register. This is corrected by adding in an additional printer control code to adjust for this condition. Use the one time only horizontal tab setting code for the number of spaces used by your control code characters. (include the spaces used by the horizontal tab control).

With the Gemini 10X printer the tab control code is ESC b n. It is entered by using CTRL U, FCTN R, CTRL U, lowercase b, CTRL U, then the character representing the number of characters used in control codes plus 64, i.e. $7+64=71$. Seventy-one is uppercase G. So to get number 7 in CTRL U, press the letter G.

You can use downloadable characters and custom commands or a mixture with regular characters. Transliteration commands for printer controls are lost when the Formatter prints to a disk. Only those .TL commands that control right and left margins, page length, fill and adjust can be used.

DataBioTics slates 4A Talk, Disk Master for Geneve

Special versions of 4A Talk and Disk Master I which take advantage of the "bells and whistles" of the Geneve" are in progress, according to Bill Moseid of DataBioTics.

The company is shipping out its Grand RAM, he says, in versions ranging from 54K to 512K.

Prices for Grand RAM are 54K, \$146.95; 128K, \$174.95; 256K, \$217.95; and 512K, \$314.95.

The prices have increased because of a

dramatic rise in the price of chips, he notes, as well as an increase in the price of copper.

He notes that the company is attempting to keep the price of the board affordable and "that's why you don't have to buy it whole hog." Everything is socketed on the board, he notes, and there are two connectors at the top, one for a product DataBioTics hopes to come out with similar to the GRAM Kracker, and another which al-

(See Page 39)

The trials of a c99 beginner

Cryptograms are puzzling

By CHARLES E. KIRKWOOD JR.

The puzzle offers a challenge that many of us cannot resist. It could be an eyeopener in the morning or relaxation after a day's work. Charles Dodgson (Lewis Carroll) wrote a series of short stories in which clues were given leading to the solution of a puzzle. Boole devised a mathematical method (Boolean Algebra) to help solve logical puzzles. Telephone switching circuits and the computer are based on Boolean Algebra.

Perhaps the most popular of the word puzzles is the Cross Word Puzzle. Other types also appear in newspapers, books and magazines. However, not too many can be programmed. Some logical puzzles can be programmed, but there is only one solution and the program becomes useless after the solution has been obtained. A program to solve certain types of cryptograms can be programmed and used over and over with new data — a new cryptogram. Here is a cryptogram program written in c99 to help solve the cryptograms that appear in many daily newspapers, some magazines, and puzzle books. It is fast and much more fun than a similar program written in BASIC. Most of the variables are global. Several functions are used when operations are repeated.

Column numbers appear at the top of the screen so that you can avoid splitting words between lines. Use spaces to go from one line to another. One letter stands for another. Terminate the cryptogram with Enter. The cryptogram is limited to four lines (160 characters).

The five most commonly used letters appear on the screen with possible answers. Following the cryptogram will be a line of unused letters. As these letters are used they are removed from the list and reinstated if they are removed from the solution.

After the word CHANGE, type the letter you want to change and after TO, the change. To start over with the same cryptogram, press 8 after CHANGE and press any key following TO. To terminate the program, press 9 after CHANGE and press any key after TO.

```

/*CRYPTOGRAM PROGRAM*/
E /*w=input (cryptogram) array*/
/*x:solution array*/
/*y=alphabet (letters not used)*/
/*k:character count*/
/*m=most used characters*/
/*l:character count for 5 most used letters*/
int i,j,n,p,f,r,s,t,u,v;
int a,b,d,e,g;
int l[50],m[50],y[100],k[100];
char x[200];
char w[200];
main()
{
  puts("CRYPTOGRAM by Charles Kirkwood\n");
  putchar(10);
  puts("Press <RNTRR>");
  a=getchar();
  putchar(12);

```

```

  puts("TYPE CRYPTOGRAM, terminating with\n");
  puts("<RNTRR>\n");
  puts("1234567890123456789012345678901234567890\n");
  for(i=1;i<=26;++i) /*initialize y with the*/
    y[i]=i+64; /*alphabet*/
  q=32;
  i=1;
  a=100;
  while(a!=10) /*input cryptogram into array w*/
  {
    a=getchar();
    w[i]=a;
    ++i;
  }
  n=i-2;
  putchar(12);
  for(i=1;i<=26;++i) /*initialize array k to*/
    k[i]=0; /*zero (0)*/
  init_x(); /*initialize x array to underscore _*/
  /*spaces, and punctuation*/
  for(p=65;p<=90;++p) /*count of each letter of*/
  { /*alphabet*/
    for(i=1;i<=n;++i)
    {
      if(p==w[i])
        k[p-64]=k[p-64]+1;
    }
  }
  for(i=1;i<=5;++i) /*selection of the 5 most*/
  { /*used letters*/
    l[i]=0;
    for(j=1;j<=26;++j)
    {
      if(k[j]>l[i])
      {
        l[i]=k[j];
        p=j;
        m[i]=j+64;
      }
    }
    k[p]=0;
  }
  while(q!='9')
  {
    puts("SUGGESTIONS:");
    putchar(10);
    for(i=1;i<=5;++i) /*output of 5 most used*/
    { /*letters in cryptogram*/
      d=m[i];
      putchar(d);
      puts(" ");
    }
  }

```

(See Page 29)

C99—

(Continued from Page 28)

```

putchar(10);
puts("E T A O N"); /*5 most used letters in*/
putchar(10);      /*English words in order*/
putchar(10);
f=n/40;
i=1;
t=40;
u=1;
s=1;
while(i<=f)
{
    output(t); /*output of cryptogram*/
    t=t+40;   /*and solution*/
    i=i+1;
    putchar(10);
}
output(n); /*output of last line of*/
putchar(10); /*cryptogram and solution*/
putchar(10);
for(i=1; i<=26; ++i) /*output of unused*/
{
    /*letters*/
    a=y[i];
    a=putchar(a);
}
putchar(10);
puts("CHANGE "); /*letters to be changed*/
q=getchar();
puts(" to ");
r=getchar();
for(i=1; i<=n; ++i) /*storage of changes*/
{
    if(q==w[i])
    {
        v=x[i]-64; /*reinsert letter in unused*/
        y[v]=x[i]; /*letter array where it*/
        x[i]=r;   /*becomes available again*/
    }
}
for(i=1; i<=26; ++i)
{
    if(r==y[i]) /*insertion of blank when*/
        y[i]=32; /*letter is used*/
}
if(q=='o')
{
    for(i=1; i<=26; ++i) /*new alphabet to*/
        y[i]=i+64; /*start over*/
    init_x(); /*reinitialize x array*/
}
putchar(12);
}
}
init_x() /*function to initialize array x*/
{
    for(i=1; i<=n; ++i)

```

```

{
    x[i]='_';
    for(j=32; j<64; ++j)
    {
        if(w[i]==j)
            x[i]=j;
    }
}
return;
}
output(g) /*function for output*/
int g;
{
    char c;
    while(s<=g) /*output of cryptogram*/
    {
        c=w[s];
        putchar(c);
        s=s+1;
    }
    putchar(10);
    if(g==n)
        putchar(10);
    while(u<=g) /*output of solution*/
    {
        c=x[u];
        putchar(c);
        u=u+1;
    }
    return;
}

```

If your typing is as bad as mine, there can be a problem with the input of the cryptogram. Since the letters are stored directly into the array `w`, any errors in typing cannot be corrected. A better input will now be written. This method makes the program longer, but will allow you to correct your input typing mistakes. The input characters will first be read into a buffer and finally stored into the array `w`. Since the buffer can only hold 80 characters, it may be necessary to input into the buffer twice. You can make corrections while typing in the first 79 characters by pressing FCTN D and again when typing from the 81st character to the finish.

Add the following declaration:

```
char buff[81];
```

Replace the input statements:

```

a=100;
while(a!=10) /*input cryptogram into array w*/
{
    a=getchar();
    w[i]=a;
    ++i;
}
n=i-2;

```

(See Page 30)

c99—

(Continued from Page 29)

with this new input:

```

a=gets(buff); /*input cryptogram into buffer*/
n=strsto(a); /*use function strsto to find string*/
/*length and store into array w*/
if(n!=80)
{
a=gets(buff); /*input into buffer, if necessary*/
n=strsto(a)+n;
}

```

Add the function strsto at the end:

```

strsto(z) /*function to find string length*/
char *z; /*and store cryptogram into*/
{ /*array w*/

```

```

int h;
h=0;
w[i]=*z;
i=i+1;
while(*z++)
{
w[i]=*z;
++i;
++h;
}
i=i-1;
return(h);
}

```

It is hoped that you will have as much fun using this program as I have.

A survey of TI owners

The following is a condensed version of a survey of TI users and user groups completed on Nov. 30, 1987. The survey was conducted by Ali Ulgen. The survey results are listed in their entirety, though wording of some questions have been condensed. — Ed.

By ALI ULGEN

The survey was returned by 73 TI user groups and 753 TI owners, most of which are user group members.

The purpose of the survey was to find out what direction TI'ers want to go in terms of software and hardware development, and to influence some of the manufacturers to produce items that are most in demand.

Of the 220 statistically active user groups in the US, 73 returned the survey. You may not agree with me, but I don't think there are over 80 active TI user groups in the US.

Thirty-five user groups returned the survey by July 1, 1987. If I hadn't sent second and third mailings, combined with telephone calls, the figure wouldn't have reached 50. The negative and positive response, in so far as to reprinting and distributing the survey were about equal. Generally, the most cooperative user groups had the fewest members.

How did I compile the results? I did it manually for the first 100. This is where one does one survey at a time. This quickly became monotonous. Actually, the plan was to do the first 100 manually in order to check out my second system's accuracy.

The second system consists of a number of X BASIC programs. The primary program goes through the entire survey asking you one question at a time. At the end of a complete survey questionnaire you are then given a simple menu to select from. You may add another, save the results, see the results on screen, load a previously saved results to add onto, or quit. I could do any amount I wanted, then save the results and later load up to add some more. The other programs for this were to load and dump to printer or load and display on screen a bar graph for each question and answer.

So I compiled the first 100 manually and then did them again using my program, which proved it to be reliable if I hadn't made a mistake in the entry. After doing the second and third hundred I found this program version slower than expected. So, I found a third way. This was also manual, but it was fast and not too boring. In this one I concentrated on one answer for a batch of surveys at a time. You go through the batch and record the answer for each question. I started with 10 but quickly found 25 to be comfortable.

For every survey returned, there had to be an answer for each question. Additionally, each question could only have one answer.

How did I get around those questions not answered or those with multiple-answers? If a respondent failed to answer a question, it was of two types. In one, it was obvious. For example: If the respondent answered

“no” to the question — “Do you own a modem?” — it was obvious that the answer to the next question, regarding baud rate, was N/A. This was simple. The second type was omission. For these I calculated the number of omissions for any given question and the response for that question and distributed the number of omissions according to the percent weight of responses. The figures for answers for a question and answer did not vary by more than one question when adjusted for omissions.

Similar steps were taken for multiple answers. The difference was to take into account those answers which received the most multiple-answer answers and provide a percent of weight accordingly. The biggest culprit for this was “How do you use your TI?”

There are two questions which were completely misunderstood or I worded incorrectly. The first is: “Do you subscribe to; UG publications?” Since 94 percent of the respondents are user group members and over about 90 percent of user groups publish a newsletter, how could only 40 percent report subscribing to a user group publication? Something was amiss here.

The second one is: “Have you plans to purchase cards by other vendors?” I was directing this question to those who were purchasing Tritons Turbo-XT. But, since only 5.8 percent of the respondents plan to purchase the Turbo-XT and 36 percent report buying cards by other vendors. Oh

(See Page 31)

SURVEY—

(Continued from Page 30)

well.

Just to let you know, here is a list of the most common questions I was told I had missed. First, RAMdisk, especially Horizon's RAMdisk. Console 32K memory. Commodore and BMC as monitor brands. Panasonic, IDS, MPI for printer brands. Wang, and TI for computers at work. Tandy as another computer brand found in the home. Note that there were others but these were the most suggested. Many wanted more items regarding cassette-based operations. And Delphi for commercial network category.

The most useless question turned out to be: "How many extras did you buy with the Turbo-XT?"

How about two surprises? No one asked why there were no questions regarding Morning Star's CP/M or Foundation's Z80 cards. Well, I was surprised. Another surprise was that no one questioned two of the answers found somewhere in the survey which were tricks to see if they would get any response. Care to guess which they were?

Some of the responses required text and

were not checkoffs and they had to be accounted for. When you examine the survey, you are going to see lowercase text by the answers which were not on the original survey. That's to account for some of the text answers. For example, lets take the question "Your occupation?" If the answer was "housewife/homekeeper" (or similar), the answer was recorded as "Blue Collar." Please refrain from death threats and hate mail. In such cases subjective judgment as to where to classify such answers were made not because it fit the answer category well but because it failed to fill any other answer category. You'll see this type of lowercase adjustment throughout the survey results.

In a related area, some respondents checked "Other" for an answer and gave the product name. In a number of such cases, the product name belonged under a given answer category and not under the category "Other." For example: a respondent may have indicated "Other" as a printer but wrote in that it was "Microline," which actually belonged under "Okidata/C Itoh." Adjustments of this nature are reflected by the lowercase

text on the survey results.

One more thing, when a large percentage of responses to a given question were taken up by the "Other" answer category, I tried to list, in order, the others that may have been written in. An example of this is Panasonic as the most common "Other" printer used. Since not all of the responses stated which "Other" was used, there is no justification for numerical count.

Survey results are to be considered to be in the public domain. Anyone may obtain a copy from me or Amnion helpline: 116 Carl St. San Francisco, Ca. 94117 (415)753-5581. Files are also available by downloading them from The Source, CompuServe, Genie or Delphi. Feel free to reprint or upload the survey. The disk from me will cost \$5 (Ali Ulgen, 952 E. Parkhaven Dr., Seven Hills, Ohio 44131).

The TI User Group survey result files can only be accessed with Navarone's DBM. However, DBM files will not be included, what you'll receive is a DIS/VAR 80 file of the 73 user groups returned to me. Filename is SURVEYG (for Survey Groups).

TI99/4A Owners Survey (Dec. 15, 1987)

Question	Resp.	Percent				
A1 What is your sex?			A25 Which brand of computer at work?			32, Tachyon, Ucomp,
Male	650	86.321%	N/A	307	40.770%	Doryt)
Female	103	13.679%	IBM	182	24.170%	A51 What size memory?
A4 What is your age group?			Apple	24	3.187%	N/A
17 or under	23	3.054%	DEC	27	3.586%	32K
18-24	28	3.719%	Sperry (Unisys)	17	2.258%	128K (104K)
25-34	114	15.139%	NEC	4	0.531%	256K (192K)
35-44	249	33.068%	Unknown	9	1.195%	512K (640K)
45 and over	339	45.020%	Other	183	24.303%	1024K
A10 How many years of education?			(Wang, TI, ITT, HP)			A58 Which disk controller card do you own?
11 or less	39	5.179%	A34 How many TI99/4 or 4As do you own?			None
12 years (high school)	155	20.584%	1	236	31.341%	TI
13-15 years	291	38.645%	2	369	49.004%	Foundation (?)
16 years	108	14.343%	3 or more	148	19.655%	Myarc
17 and over	160	21.248%	A38 How many PEB systems do you own?			CorComp
A16 Your occupation?			0	114	15.139%	Other (Percom,ICS)
Student	32	4.250%	1	472	62.683%	A65 How many 5 1/4" disk drives do you own?
Blue collar (homemaker)	187	24.834%	2	136	18.061%	None
White collar	137	18.194%	3 or more	31	4.117%	1
Professional			A43 Which memory expansion do you have?			2
(self-employed)	246	32.669%	None	56	7.437%	3 or more
Retired	151	20.053%	TI	458	60.823%	A70 Configuration (disk drives)?
A22 Do you use a computer at work?			CorComp	80	10.624%	N/A
Yes (or school)	439	58.300%	Foundation	24	3.187%	SS/SD
No	314	41.699%	Myarc	63	8.367%	DS/SD
			Mechatronic	4	0.531%	DS/DD
			Other (Horizon, console			

(See Page 32)

SURVEY RESULTS

(Continued from Page 31)								
Question	Resp.	Percent						
DS/QD	16	2.125%	25 or more	303	40.239%	50-74	106	14.077%
A76 Do you own a hard disk system?			A132 How many software disks do you own?			75-99	67	8.898%
Yes	16	2.125%	9 or less (including 0)	118	15.671%	100-150	28	3.719%
No	737	97.875%	10-24	124	16.468%	151-199	14	1.859%
A79 What's the size?			25 or more	511	67.862%	200 or more	11	1.461%
N/A	734	97.477%	A136 How do you use your TI?			A195 Are you a member of a commercial network?		
10 meg. or less	8	1.062%	Entertainment	290	38.513%	Yes	248	32.935%
20 meg. (11-29)	10	1.328%	Business (word processing)	137	18.194%	No	505	67.065%
30 meg. or more	1	0.133%	Education	125	16.600%	A198 Which one?		
A84 Do you own a modem?			Programming	201	26.693%	N/A	507	67.331%
Yes	524	69.588%	A141 Programmers; What do you program in?			CompuServe	117	15.538%
No	229	30.412%	N/A	200	26.560%	Source	31	4.117%
A87 Indicate the highest baud rate?			BASIC	69	9.163%	Genie	56	7.437%
N/A	227	30.146%	XBASIC	364	48.340%	Other (Delphi, Frenet, Plink)	42	5.578%
300	291	38.645%	Assembly	68	9.031%	A204 How much in dollars do you use it per month?		
1200	224	29.748%	Forth	20	2.656%	N/A	501	66.534%
2400	11	1.461%	C	25	3.320%	\$29 or less	150	19.920%
A92 Which printer do you own?			Other (Logo, Pascal)	7	0.930%	\$30-\$49	76	10.093%
N/A	74	9.827%	A149 Ever write a commercial program for TI (include Freeware)?			\$50-\$74	17	2.258%
TI (includes thermal)	71	9.429%	Yes	89	11.819%	\$75-\$99	6	0.797%
Epson	149	19.788%	No	664	88.181%	\$100 or more	3	0.398%
Prowriter/NEC (Leading Edge)	39	5.179%	A152 In what language?			A211 Do you plan to purchase (or have) the Myarc 9640?		
Okidata/C. Itoh (Microline)	38	5.047%	N/A	657	87.251%	Yes	226	30.013%
Star Micronic (Gemini)	187	24.834%	BASIC	12	1.594%	No	527	69.987%
Comrex/Toshiba	3	0.398%	XBASIC	54	7.171%	A214 What software area you would like for the 9640?		
Brother/Cannon	10	1.328%	Assembly	17	2.258%	N/A	340	45.153%
Juki/Citizen	18	2.390%	Forth	6	0.797%	CAD/Graphics	69	9.163%
Other (Panasonic, IDS, MPI)	164	21.780%	C	5	0.664%	Desktop publishing	118	15.671%
A103 Do you own a monitor?			Other (Pascal)	2	0.266%	Database manager	137	18.194%
Yes	455	60.425%	A160 Do others use your TI?			Word proc/spreadsheet	70	9.296%
No	298	39.575%	Yes	516	68.526%	True BASIC	7	0.930%
A106 Are you using a TV?			No	237	31.474%	Assembly language	11	1.462%
Yes	399	52.988%	A163 How many others?			C language	1	0.133%
No	354	47.012%	N/A	235	31.209%	Other language	0	0.000%
A109 Which monitor brand?			1	184	24.436%	A224 What about hardware for the 9640?		
N/A	290	38.513%	2	217	28.818%	N/A	335	44.489%
TI	117	15.539%	3 OR MORE	117	15.538%	Apple compatibility	17	2.258%
Amdek	32	4.250%	A168 Do you own any other brand of computer?			IBM compatibility	171	22.709%
Sanyo/Taxan	28	3.7198%	Yes	209	27.756%	RGB monitor	43	5.711%
NEC	32	4.250%	No	544	72.244%	3.5" micro disk	66	8.765%
Tatung/Samsung	13	1.726%	A171 If so which brand?			CD ROM	16	2.125%
Magnavox/Sony	51	6.773%	N/A	540	71.713%	Speech recognition	9	1.195%
Epson/Prnston	7	0.930%	IBM	60	7.968%	Internal modem (intelgnt)	96	12.749%
Hitachi	5	0.664%	Apple	18	2.390%	A233 Do you plan to purchase (or have) Triton's Turbo-XT?		
Other (BMC, Commodore, Panasonic)	178	23.639%	Commodore	48	6.375%	Yes	43	5.711%
A120 Is your monitor?			Atari	19	2.523%	No	710	94.290%
N/A	305	40.505%	Other (Tandy, HP, Timex)	68	9.031%	A236 How many extras did you buy with the Turbo-XT?		
RGB	65	8.632%	A178 Approximately how many hours per week do you use your TI?			N/A	733	97.344%
RGB/Composite	291	38.645%	4 or less	230	30.545%	1	10	1.328%
Monochrome	92	12.219%	5-9	257	34.130%	2	5	0.664%
A125 Do you have the GRAM Kracker?			10-14	117	15.538%	3	4	0.531%
Yes	82	10.890%	15 or more	149	19.788%	4	1	0.133%
No	671	89.110%	A183 Are you a member of a users group?			5 or more	0	0.000%
A128 How many software cartridges (modules) do you own (include cassettes)?			Yes	717	95.219%			
9 or less (including 0)	131	17.397%	No	36	4.781%			
10-24	319	42.364%	A186 How many members?					
			N/A	36	4.781%			
			33 or less	282	37.450%			
			34-49	209	27.756%			

(See Page 34)

Geneve 9640

Programming tools available

By MIKE DODD

Mike Rotolo, of Rivervale, NJ, asks several questions about the Geneve for prospective buyers.

What support is available for programmers, especially A/L? Currently, very few programming utilities are available. Paul Charlton has written a fairware (\$15 fee requested) Linker program that loads assembly object files into MDOS and then saves them in program image format. Charlton has also written files documenting many of the programming interfaces into MDOS, but the documentation is rather sparse. Some programming information has been revealed in this column. Al Beard has written a simple public-domain debugger program, similar in operation to TI Debug. Other programmers are known to be working on or planning to work on assembler utilities and more advanced debugger programs. Myarc is working on a package known as "Programmers Development Package." The package will include a linker program, an assembler, and a screen-based debugger (probably similar to the TI Debug or Superbug programs). The package will also include a manual detailing the operation of the programs, as well as programming on the 9640. The package should be available sometime by the end of the summer.

What software is available now (e.g. databases, word processors, terminal emulators)? The only word processor program specifically written for the 9640 is MY-Word, written by J. Peter Hoddie. MY-Word loads in 80 columns, has online help screens, a 56K text buffer, and many other features. The only advertised feature not currently implemented is formatting disks—MY-Word does not have support for formatting operations. MY-Word may one day be written to load from MDOS, but with V1.1 and earlier, you must enter GPL mode to load the program.

There are several terminal emulators that will run on the 9640, but only a few support any of the Geneve's extra features, and even then, it is only the 80 column screen mode. Paul Charlton has written a version of Fast-Term that will run on the

Geneve and uses either 40 or 80 columns. There is a version of Mass-Transfer V3.9 that has been modified to run in 80 columns. Other 99/4A terminal emulators that work on the 9640 include P-Term and some versions of TE-II. Dave Ramsey, a talented programmer from the Washington D.C. area, has said that he is working on a terminal emulator to run from MDOS.

There are no Geneve-specific database programs written. Many databases for the /4A will work on the 9640, but, of course, they do not take advantage of any of the Geneve's extra features. Warren Agee has said that after he completes the 99/4A version of FirstBase, a new database program he is working on, he intends to write a version that uses the Geneve's extra features (i.e. memory, 80 columns, etc).

What software is in realistic development? The biggest two pieces of software currently under development are from Myarc: Advanced BASIC and the Pascal Interpreter that will be shipped to all registered Geneve owners upon completion. Other programmers are actively working on mouse support software and a big C Compiler.

Is the operating system complete? No. V1.01 has been released, but it is still not complete. The two main features not implemented in MDOS are screen scrolling (viewing the contents of screens that have scrolled off) and graphics screen dump.

An explanation of the usage of MDOS and GPL seems in order, for those who do not yet own a Geneve: when you first turn on the computer, the Geneve loads MDOS (filename of SYSTEM/SYS) from disk. This file is 358 sectors, and thus fills an entire SS/SD disk. From MDOS, you can run programs written in the "native" mode of the 9640 (e.g. MY-Art and Paul Charlton's fairware GIF converter) and do several disk operations (e.g. copying, formatting, etc). The command structure is similar to MS-DOS. From MDOS, you can load a program named GPL, supplied on a separate disk (although if you have disks larger than SS/SD, you can place both SYSTEM/SYS and GPL on one disk). GPL sets up the computer so as to emulate a 99/4A. From GPL, you can load

your saved cartridges and run them, just like a 99/4A. As things stand now, most users probably enter GPL mode most of the time, as very few applications currently exist that will load straight from MDOS.

Several people have asked about the usage of the hard disk controller with the Geneve and the 99/4A. The hard disk controller as released will work with either the 99/4A or the Geneve 9640. The package will include Myarc Disk Manager V, a disk manager based on the Myarc DM III program. The disk manager (known as MDM5) will work on both the 99/4A and the 9640.

Another common question has been whether or not you can use a non-Myarc mouse with the Geneve. It is true that some mice will cause damage to the Geneve if hooked up incorrectly. However, a file has been uploaded to GENIE and other public bulletin board systems containing a cabling diagram to connect a Logitech mouse (designed for the IBM PC) to the Geneve. The Logitech mouse can be obtained for around \$60-80, perhaps less if you shop around. Note that the Myarc Mouse package (which costs \$125) also includes a copy of the MY-Art drawing program, which can not be purchased separately.

Helpful tip from J. Peter Hoddie: if you plan to enter GPL from MDOS, do NOT setup a print spooler (via the SPOOL command) from your AUTOEXEC file. The reason for this is that memory becomes allocated for the print spooler, but as the current versions of GPL (V0.99 and lower) sets aside a fixed area of memory, the extra memory for the spooler becomes overwritten, causing lockup.

Another important note: there have been versions of GPL floating around labeled V1.0 or above. These versions appear to be counterfeit — no one at Myarc produced the versions. The latest official release from the programmer of GPL, Paul Charlton, was V0.97.

Now that MDOS has been released, some small programs are starting to be written for it. Paul Charlton has released a linker and XOP technical manual for pro-

(See Page 36)

SURVEY RESULTS—

(Continued from Page 32)						
Question	Resp.	Percent				
A244 Would you like an AT update for the Turbo-XT?			A253 Do you plan to purchase (or have) a mouse?			
Yes	177	23.506%	Yes	246	32.669%	No
No	576	76.494%	No	507	67.331%	A265 Do you subscribe to Genial Traveller?
A247 Have you plans to purchase cards by other vendors?			A256 Do you subscribe to MICROpendium?			Yes
Yes	272	36.122%	Yes	420	55.777%	No
No	481	63.878%	No	333	44.223%	A268 Do you subscribe to UG publications?
A250 Do you plan to purchase (or have) the Rave 99 keyboard?			A259 Do you subscribe to Smart Programmer?			Yes
Yes	107	14.210%	Yes	125	16.600%	No
No	646	85.790%	No	628	83.400%	A271 What is your opinion of this survey?
			A262 Do you subscribe to Computer Shopper?			Very poor
			Yes	249	33.068%	Poor
						Okay
						Good
						Very good

HORIZON—

(Continued from Page 33)

now, the biggest expense for a hard disk would be the controller.

MICROpendium: You sold these kits or cards at the Chicago TI Faire. What kind of reaction or success did you have there?

Mills: I took nine kits to Chicago. Of the full 3 megabyte kits, 2 of those went to Italy, and one went to Holland. Of the other 6, 1 went to Ottawa, and most of the rest of them stayed in Chicago. Right after the Chicago faire I went up to Milwaukee and met Jim Schroeder. He is very active with the Geneve. Jim was showing how the Horizon card would boot the system. I said "Jim, check and make sure this 1 meg card is compatible with the Geneve." So he dropped it in the box and he did some formatting and he said "Oops." The Geneve will only allow the card to be formatted to 1440 sectors, period. Then his software only accesses 1150 before it starts writing over and destroys your table. He said, "We ought to be able to fix that." I said, "Okay, Jim, hang on to that card and see if you can't come up with a software patch that will patch the Geneve." Which he did. The software is available on Genie right now to allow you to modify the SYS file for Geneve that will allow you to format an 80-track drive on the 1 meg card. But since that 80 track drive only uses 800K, I went ahead and made available an 800K HRD kit. There is no point in buying extra memory if you don't need it.

MICROpendium: So the bottom line at Chicago, was it was successful?

Mills: I sold all the cards I took there, plus I took orders for another 25 cards.

There are actually about 20 cards in existence in the HRD+ format. Of those there are probably 10 1 meg cards.

MICROpendium: What would be the minimum investment just to get into this?

Mills: The absolute bare bones minimum for a 96K RAMdisk is \$140 from me. But for just an extra \$25, or \$165 total, you get all the way up to 192K. That's 6 of the 32K chips. Starting out with the bare minimum configuration would not be the most economical. The extra \$25 gives you the equivalent of a double-sided single density RAM drive. The increments from there on up is like \$11 a chip for each 32K. I've still got the 6264 chips, the console memory expansion, and then the individual chips here. I have since found some 200 nanosecond chips that are even cheaper yet, but I'm not sure we want to use those. The timing is usable. You could probably go 500 nanoseconds and be usable. But we wanted the Horizon to use only first class chips, such as the 120 or 150 nanosecond ones. We're using 150s in the 8K and 120s in the 32K console memory kit. We have been going with the better chips.

MICROpendium: You have a memory addition that gives you 32K directly on the 16 bit data bus. Is that correct?

Mills: Right. Physically, we are using two 32K chips. But actually, we are only using 16K out of each chip, because one chip sets across one half of the 16 bit data bus and the other chip sets across the other half.

MICROpendium: How about speed? Would this be any faster than the normal memory expansion? It's definitely cheaper.

Mills: Normal Multiplan recalcs are twice as quick. What happens is for the standard 32K, your processor sends out 16 bits, and then the interface says 'Okay, I'll take the first 8 bits, send it to the memory, take the second 8 bits, and send it to the memory.' So you've got all that interpolation time. We eliminate that. So you do get about a 49 percent increase in speed.

MICROpendium: Do you have any other projects going besides the 32K expansion and the RAMdisks? Do have anything else on the burner? Any thing you want to talk about?

Mills: Not really, I did get a hold of some of the proto cards and was putting together a kit for 8K DSR. What I'd like to see (John) Willforth and Western Pennsylvania group do is produce a clock schematic for use with their card plus a print spooler. And, if it looks like that's a reasonable project, and looks like there's enough demand for it, I'd stock parts for it.

SF 99ers to take part in West Coast Fair

The San Francisco 99ers plan to take part in the West Coast Computer Fair April 7-10 in the Moscone Center in San Francisco, California.

This is the 13th year for the annual event, according to Neil Wood of the SF 99ers, who says approximately 70,000 persons attended last year.

Wood says Barbara Wiederhold of the Queen Anne Computer Shoppe in Seattle is scheduled to demonstrate products from Miller Communications April 9-10.

Horizon history outlined

Bud Mills discusses hardware

By GARY D. BISHOP

Cedar Valley 99'er User Group

MICROpendium: Would you describe your product, and your service to the TI community?

Mills: The Horizon RAMdisk circuit was dreamed up by Ron Gries. He put it together and made it work. Then Dave Romer and John Clulow wrote the software to control the card. Later some enhancements were made by Peter Hoddie. The card maximum size was 180K in the format that Horizon produced. Horizon made the card itself plus the software that controlled it. They really didn't want to get into the parts business, though. So I now carry all the parts for the card.

MICROpendium: How did you get into the parts business?

Mills: Well, when Clulow and Gries were putting together the initial hand-wired one, they paid like \$50 for one memory chip. Then the price went to \$37.50 per chip. So they bought a couple of those, and they kept adding to this one card. Then the price went to \$9 per chip. I said, 'if it's falling that fast, and you guys are still dealing with retail dealers, let me make a few phone calls.' My normal job does involve tracking parts. I had a vendor's license already. I was able to find a source and I bought chips for them for under \$5 each. That is when I locked in as their supplier.

MICROpendium: What were your original goals?

Mills: We looked at how many we thought could actually sell as a percentage of the number of P-boxes out there. So, how many P-boxes were built? The figure was near 300,000. If you take 10 percent of that, it would be 30,000. I figured there was about 10,000 that were in some state of active use. So, that's our market we were looking at, that 10,000. We figured we'd be real fortunate if we could get 10 percent of the active market. We did that, so far. That was our projection. Let's go back to 300,000 that were actually built. If the 10 percent rule still holds true, I'm going to sell a lot more cards. And I'm only scratching the surface. In two year's time we've sold over a thousand RAM-cards, and I sold about 800 of the kits. You can buy the parts from the local parts

Horizon purchased by Bud Mills Services

Horizon Computer Limited has been purchased by Bud Mills Services. Orders for Horizon products should be sent to Bud Mills Services, 166 Dartmouth Dr., Toledo, OH 43614. Phone is (419) 385-5946.

In the interview on this page by Gary Bishop for MICROpendium, Mills discusses Horizon products, including the new HRD+ RAMdisk.

houses. Last year I sold over 10,000 of the 8K chips. In two months, I've already sold over 1,000 of the 32K chips.

MICROpendium: So that's a pretty encouraging sign.

Mills: We're looking for it to pick up a little more. I still haven't mailed out any advertising yet. What I've done since the first of November is to put 40-45 HRD+ kits, or the 1 megabyte kits, in the field that have been built up and are viable. The beta test is complete, I'm secure with that.

MICROpendium: It seems you've done fairly well without any kind of heavy advertising at all.

Mills: I hope my reputation has been established. I've received very positive feedback from my customers.

MICROpendium: Would you describe the instructions?

Mills: The instructions are from Horizon. They made it so anybody that would buy their card would get the software and the instruction book with it. You could go out to the local Radio Shack and buy everything you needed. It would use standard parts. Well since then, Radio Shack quit handling a lot of the parts. I went into buying complete sets, 100 sets at a time, of all the parts except the memory. When I needed the memory, I'd buy that 10 or 15 kits at a time. So my investment would be relatively secure and I could package it because I didn't have a whole lot of dollars invested. Then I could sell at a savings to the TI community.

MICROpendium: Is a 3 megabyte RAM drive really necessary, or the best method to try to configure a system?

Mills: No, it's not going to provide you with the 100 percent ultimate machine.

MICROpendium: How does it operate?

Mills: The card file management is set up so you can configure up to 10 drives on a 1 Meg card. For 3 megs, you add additional layers of memory chips. This takes

up more width in the P-box. The control lines are all there, the software will allow you to divide the RAMdisk into 10 separate drives. Now, we only use two drive numbers, but every drive you configure has to have a drive name. Then, in accessing the RAM drive your system will automatically look for a drive name so it could be one of the upper drives. When you access that drive, it pulls that whole drive into the window of the second drive number.

MICROpendium: So it pages in and out of the drive number?

Mills: Right. Now the first drive number is set up to contain your menu program, disk manager, etc. You have 1440 sectors maximum on each drive name, until you run out of space on the card. So, with the 1 meg, you get two 1440 sector drives, and one 185 sector drive. Or you can have 10 90K drives.

MICROpendium: So this card you simply drop in the P-Box, can this card boot the system?

Mills: Not yet that I know of. The Geneve does a thing with the 8 bit data address and this card has a 16 bit data address that allows us to go to 1 meg. We can actually go to 16 meg as far as the addressing is concerned, but there are other drive limitations on the card.

MICROpendium: What is the maximum configuration you can have? You said the address scheme with 16 address lines you could go up to 16 megabytes, but for a kit we could purchase from you reasonably, is that the 3 megabyte kit?

Mills: I would not recommend going over the 3 meg line. You're talking \$600. That's pretty steep. Plus, at that amount of money, you can start talking hard disk. You can buy surplus hard disks, the 10 megs and the 5 megs, for \$50 or so. Right

(See Page 34)

GENEVE—

(Continued from Page 35)

gramming. These are available on CompuServe and many other networks and public bulletin board systems. Writing a program for MDOS is quite different from a 99/4A program. On the 99/4A, interrupts were frequently disabled (via the LIM1 0 instruction), and programs would often access VDP, either by self-contained VDP utilities, or by using the VDP subroutines automatically loaded into memory with the Editor/Assembler Load & Run option. Under MDOS, however, programs should not ever directly access VDP, nor should they ever disable interrupts. The reason for this is the possibility of multitasking — MDOS has all the code embedded in it to allow multitasking. Eventually, programs will be undoubtedly be written that use that feature. If your program directly accesses VDP, then MDOS does not know what has happened, and may then pass incorrect information to other tasks, or fail to restore all of the memory correctly. If programs disable interrupts, then MDOS will not be able to activate multitasking when it needs to. Since, of course, all screen display requires usage of VDP, DOS contains a powerful set of standardized routines for programs, performing many operations. MDOS programs access these routines via the XOP command, a little-used command on the 99/4A. XOPs are similar to the BLWP instruction.

The XOP calls are documented in Charlton's XOP manual — the following is intended as a general overview explaining the concept of using the XOP calls.

The XOP calls are divided into several major categories: DSR access (i.e. disk drive, printer, etc), keyscans (and joystick), memory management, math, misc. utilities, and video display routines (which also includes mouse support calls). Each section (called a "library") has a number—DSR is 8, misc. utilities is 9, and so on. You then access that library with the following instruction:

XOP @number,0

Where number can be any label containing a word with the number of the library to call, i.e:

EIGHT DATA 8

XOP @EIGHT,0

would access the DSR library.

Most libraries also have several functions that are a part of it — the Video library has functions for setting video mode, writing text, reading the mouse, and many others. These functions have numbers, i.e. "Set video mode" in the Video library is opcode number 0. You pass the opcode number in R0. Other parameters are usually passed in other registers. For instance, to set Text 2 mode (80 columns), you would use the following sequence:

```
SIX    DATA 6 No. for vid. lib.
.
.
LI     R0,0    opcode 0—set video mode
LI     R1,1    number for text 2 mode
XOP    @SIX,0  access function
.
.
```

The most confusing part of the XOP manual concerns memory mapping. MDOS has very complex and powerful memory management subroutines — figuring out how to use them is the trick.

Here is a definition of the terms:

Physical page number — a number from >00—>FF pertaining to the actual page number of a given 8K block of memory. These page numbers follow the scheme explained in the September 1987 MICROpendium.

Execution page — a number from 0—7. Execution page 0 is the memory from >0000->1FFF, page 1 is from >2000->3FFF, and so on, up to page 7, which is for >E000->FFFF.

Local page number — a number from >00—>FF. These are abstract page numbers, in the sense that they have no correspondence to either physical or execution page numbers. Local page numbers are important, however, as your program accesses addition blocks of memory via the local page number.

Execution address — from >0000—>FFFF. This is an address that points into the currently mapped memory — that is, execution address >6000 corresponds with whatever memory is currently mapped into >6000.

System address — from >000000—>1FFFFFFF. This address points to a page number and address — system address >000000 points to local page

>00, address >0000. System address >123456 points to local page >91, address >1456.

When your program is loaded, local page 0 is mapped into execution page 0 (>0000—>1FFF). You can not map another local page into execution page 0. If your program is larger than the memory available in execution page 0 (program space in that page is from >0400—>1FFF), MDOS will continue loading at >2000 and above, automatically allocating local pages and mapping them in to the execution pages. If your program was >3A20 bytes long, it would load from >0400—>3E1F. Your program would then have two pages of memory mapped in — execution page 0 would contain local page 0, execution page 1 would contain local page 1. There would be no RAM anywhere from >4000—>FFFF, with the exception of >F000—>F07F, which is Fast RAM — normally used for workspace registers. Your program should not access or change memory from >0000—>03FF, >F080—>F13F, or >FFFA—>FFFF, as those areas are reserved for MDOS.

Since your program will most likely require additional RAM, you must request pages from MDOS. Almost all programs will need to allocate a page into execution page 7 (>E000—>FFFF), as the video subroutines (i.e. displaying text on the screen) requires all parameters to be passed to it in execution page 7.

To request additional pages of memory, you must use opcode 1 - get local pages. You will need to pass the following parameters: number of pages to get, starting local page number, and speed flag. The speed flag is set to >0000 if slow memory is OK, >FFFF is you need fast RAM (keep in mind that as there are only four fast RAM pages in the Geneve, use them only if absolutely necessary). For example: suppose your program was >05B0 bytes long, and thus loaded from >0000—>09AF. MDOS has allocated local page 0 and mapped it into execution page 0. Your program needs a RAM page at >E000. Since local page 0 is taken, the next page to request would then be local

(See Page 37)

GENEVE—

(Continued from Page 36)

page 1. The following example will request one page at local page 1, slow memory:
SEVEN DATA 7

```
LI R0,1 opcode 1-get local pages
LI R1,1 get one page
LI R2,1 local page number
CLR R3 slow memory is fine
XOP @SEVEN,0 get memory
```

MDOS has now allocated a physical page number for local page 1 — but you still need to map it into execution page 7. There are two ways to do this. The easiest is by calling opcode 3 — map local page at execution page. You pass it the local page number and the execution page number, and MDOS will map it in.

```
LI R0,3 opcode 3-map local page
      @ execution page
LI R1,1 local page number
LI R2,7 execution page
```

7->E000->FFFF

XOP @SEVEN,0

The other method would be to use opcode 4 — get address map. This returns a block of data containing the physical page number for each local page number. Byte 0 (the first byte) of the data block would be the physical page number for local page 0. Byte 6 would contain the physical page number for local page 6. After getting the data block, your program can map the page numbers into the mapper directly via the MOV B instruction. This method can be accomplished like this:

```
MAP BSS 8 room for local page
      numbers 0-7
MAPPER EQU >F110 address for 9640
      memory mapper
```

```
LI R0,4 get page map
LI R1,MAP place to store map
LI R2,8 eight bytes long
XOP @SEVEN,0 call it
```

MOV B @MAP+1,@MAPPER+7

local page 1 into execution page 7

The first method for mapping memory is usually better if you are setting up memory to be used for the rest of the program, as it is easy to accomplish. The second method is preferable if your program is changing the memory map frequently, as it is much faster.

There are other memory management functions which can be called from MDOS programs, as well — this tutorial is intended to get you started. Future articles will cover some of the other memory management calls. Thank you to Paul Charlton for his help with my many questions about memory management!

Readers with questions about the Geneve or problems may write Dodd at 116 Richards Dr., Oliver Springs, TN 37840. Questions may be answered in this column. Personal replies cannot be guaranteed.

Programming in MDOS

Developing autoexec and batch files on the Geneve

By WALT HOWE

Copyright 1988 by Walt Howe

MDOS, in addition to being a set of utilities for managing disks, files, and devices, is also a programming language. A series of commands that you would use directly from the MDOS prompts can also be recorded in a text file (called a batch file) and run just like a program. With it you can configure your system, customize your screens, set up menus, and simplify and standardize frequently used routines.

To create a batch file, you can use a word processor, such as MY-Word. If you do, use the Program Edit option, not the Text Edit, to write and save your file. You should not have control codes, such as carriage returns, in your text, and you should not save the tab and margin settings as the Text Editor does when you save with the SF function. The Program Editor automatically saves in the proper format. If you use the Text Editor, save with PF function (eliminating tab and margin information) and prefix the filename with a C and a space, which eliminates the control codes.

A simpler way to create a batch file is to use the the MDOS command COPY CON FILENAME. If you type COPY CON AUTOEXEC, for example, it will open a file in the A> drive named AUTOEXEC. Each line you subsequently type will become part of that file when you finally enter a control-Z to finish the file.

SYSTEM CONFIGURATION

At powerup, MDOS looks for a file named AUTOEXEC, either in a Horizon RAMdisk or equivalent, a hard drive, or on disk drive 1. Any and all routines that you want to run automatically at power up should be in the AUTOEXEC file or a file called by it. The most common applications for it are to set up a RAMdisk, customize your prompts, and to load GPL mode automatically. When GPL is in final form, Myarc has indicated that you will be able to set up a RAMdisk, automatically load it with frequently used files from floppy or hard disk, and carry that RAMdisk with its contents over to GPL mode if you wish. That capability is not supported with GPL version .99, the most recent version

as of this writing.

Here is a sample AUTOEXEC file, with comments, that you could use now to set up your system:

```
MODE 80 (Sets 80-column display.)
RAMDISK 180 (Uses 180k of RAM as a
RAMdisk at DSK5.)
ASSIGN C=DSK5: (Equates the letter C
to the new RAMdisk.)
DIR /W (Displays a directory of DSK1 in
wide form.)
PAUSE (Pauses waiting for you to press
a key.)
PAUSE (The second pause gives you a
chance to interrupt the batch file by press-
ing control-C.)
B: (Sets the B drive as the default drive.)
GPL (Unless you have interrupted with a
CTRL-C, it proceeds to look in DSK2 for
the GPL files and loads the TI mode, if
found.)
```

CUSTOM SCREENS

With the use of the ECHO command and the PROMPT command, you can customize your MDOS screens. The ECHO command lets you control whether
(See Page 38)

MDOS—

(Continued from Page 37)

or not batch file commands are displayed on screen, and further lets you put messages of your own on the screen.

The AUTOEXEC file above could be improved somewhat by adding several ECHO commands.

ECHO OFF (Subsequent commands are not displayed.)

ECHO My message (Text following ECHO is displayed, however.)

ECHO (Inserts a blank line on screen.)

RAMDISK 180

ASSIGN C=DSK5:

DIR /W

ECHO Press CTRL-C to stop. Press any other key to load GPL.

ECHO Make sure GPL files are in DSK2.

ECHO

PAUSE

PAUSE

B:

GPL

Through the use of the ECHO command, you can place any text you want on your custom screen.

The PROMPT command lets you put another personal touch on your screens. Instead of the A> prompt, you can control the appearance of the prompt, for example, adding the date and time to each prompt, adding your own messages, or even creating multi-line prompts. Refer to page 75 of the manual for the specific codes that you can use. Here are some possibilities and the results they create.

PROMPT LOOKS LIKE

```

$N$G          A>
ST$B$N:      12:34:56 A:
ST$H$H$H$B$N$G 12:34 A>
SD$B$T$_DSK$N$G 02-20-88 12:34:56 DSKA>

```

There are many more possibilities. The examples are included just to give you some ideas.

MENUS IN MDOS

It is possible to use MDOS to set up personal menus that you can use to determine what you do next. There are several approaches that can be used. The simplest and least elegant approach is to set up a menu with ECHO commands with choices A, B, C, D, etc., and name the files that they call by the same single letters. For example:

ECHO My Menu

ECHO =====

ECHO A. MYART

ECHO B. MY PROGRAM

ECHO C. GPL

ECHO D. INITIALIZE A DISK

ECHO E. MDOS

ECHO

ECHO <Enter your choice>

To put the above menu into effect, you will need to create additional batch files named A, B, C and D. None is needed for E. Entering the letter has the effect of calling a file with the name of the letter you pressed. The files could be as follows:

The file named A: DSK2.MYART

The file named B: DSK3.MYPROGRAM

The file named C: DSK6.GPL

The file named D: ECHO FORMAT MENU

ECHO =====

ECHO D1. Initialize single density

ECHO D2. Initialize double density

ECHO D3. Initialize quad density

ECHO D4. Return to MDOS

ECHO

ECHO <Press D and a number and Enter>

Now in turn you need to create files named D1, D2, D3, and so on, each consisting of appropriate formatting commands. You cannot use A, B, C, etc. again, because they are already in use. This approach can work well for very simple applications, but it can get very complicated very fast!

A BETTER APPROACH TO MENUS

Another approach to creating your own menus, is to make use of parameter passing and the IF command. With the following approach, each menu requires one additional file, not one for each choice on the menu. If you follow a filename with additional text after a space, the added text is treated as parameters for the file. You can pick up and use the parameters by using the character % and one or more numbers. Type COPY CON MENU (or include it in your AUTOEXEC).

ECHO MENU

ECHO =====

ECHO A. GPL

ECHO B. MYART

ECHO C. MDOS

ECHO

ECHO <TYPE "N", SPACE, AND SELECTED LETTER>

Next, type COPY CON N and the file

below. Substitute any other drive numbers or file names, if you wish.

IF %1==A DSK1.GPL

IF %1==B DSK2.MYART

IF %1==C ECHO MDOS—GO AHEAD

When you type N and a letter in response to the first file, you are calling the new file titled "N" and passing it a parameter of A, B, or C, which is read by the symbol %1 in the new file. If two parameters had been passed, the second parameter would be referred to as %2. Note that a double equal sign (==) is required.

This approach requires fewer files and less disk access. You can create multi-layered menus with much less difficulty. These menus can save time if thought out and called from a RAMdisk or hard disk.

There is still much more that can be done with batch files than has been shown here. Readers with interesting or creative batch applications for the 9640 who would like to share them may drop me a note at 43 S. Chelmsford Rd., Westford, MA 01886. I'll acknowledge all applications that are used in this column.

In articles to come, I will look at more applications for MDOS. I am working with the coming Myarc Hard Disk Controller now and when it is released, we will look at how to get the most out of your hard disk under MDOS.

CORRECTION

Last month's article on MDOS contained an error. To copy all six GPL files from drive B to drive A, the simplest command from the A prompt is:

A> COPY B:GP*

The command shown (COPY GP* B:) would try to copy from A to B.

MISCELLANY

Paul Charlton has released a patch to TI LOGO to enable it to run on the Geneve. The file is available on CompuServe, and other places.

Jim Schroeder has released an unfinished, but usable terminal emulator with XMODEM transfers that loads directly from MDOS. It is fairware, and Schroeder says he will continue development on it only if he gets encouragement in the form of contributions from users. At present it lacks any text buffer, so it cannot capture or pass text files. It is on many of the information services, or write him at 2856 N. Holton St., Milwaukee, WI 53212.

Myarc to protect some software

Myarc Inc. has announced a policy designed to protect major software releases from pirates. The hardware-based protection scheme will make it virtually impossible to operate a protected program without a card that must be in place in the TI PEB.

The card will be made available free of charge to current Geneve owners.

Protected software will be sold with a credit card-sized cartridge that is plugged into the protection card in the PEB. A code will be dumped from the cartridge into the PEB card and then the cartridge can be discarded. (Provision may be made for a rebate on the cartridge because they can be reprogrammed by Myarc.) The code can be read once and written once.

When loading the protected software, the program will look for the code in the PEB card. If it finds it, it will load. If not,

it won't run.

Spokesman Jack Riley says the protection scheme has been under development for months. He notes that MY-Art has been widely copied and distributed without authorization. MY-Art is distributed by Myarc only to purchasers of the Myarc Mouse. However, because of the expense involved in this protection system, only software priced at \$100 or more is expected to be protected in this manner.

Each PEB protection card will be able to hold codes for up to 50 programs, he said. Several cards can be loaded into the PEB simultaneously. The program itself won't be protected, just access to it, so the software can be used on any 9640 as long as the protection card is plugged into the PEB.

The protection system will be offered for use by third-party developers, he said. Developers may write to Riley at Myarc (P.O. Box 140, Basking Ridge, NJ 07920) for more information.

NEW KEYBOARD DEBUTS

The Geneve now comes with a new, 101-key keyboard that includes 12 function keys. Manufactured by Fujitsu, the keyboard includes function and control keys on both sides of the space bar, isolated cursor keys to the right of the main keypad, and a numeric keypad to the right of the cursor keys.

The new keyboard uses a slightly modified version of MDOS to address the additional keys — the AT-style keyboard previously sold with the Geneve has 96 keys.

DATABIOTICS—

(Continued from Page 27)

allows the user to put in new products.

Moseid says the Grand RAM uses the TMS 9901, the same chip as in every RS232 card. With the chip on the board, it can generate external interrupts, where the board can interrupt the console.

When an interrupt is generated, the console stops and checks with each board. The Grand RAM can see if the print spooler is on and checks for Hot Keys. A file can be saved to a device named Spool. The spooler checks "about 24 times a second" to see if the printer is ready, "so the printer is kept busy regardless of what you do with the rest of the system if the power is on."

Moseid notes that if the user loads something the print spooler will stop while the program being loaded is accessed, but will start up again automatically.

Hot Keys are a "unique key combination that makes something happen," he says; e.g., Control Shift T to turn off the clock, or Control Shift L to load a file from Grand RAM. The keys are user-defined and once they are set in can be scrolled through to be changed individually.

The user is able to increase or decrease the memory in the spooler, Moseid says, and to partition memory in the disk drives.

The memory is divided between the drives and the print spooler and can be allocated "like cutting a pie — sometimes you cut a bigger piece for one than another."

The user presses S for spooler, then S again for type of spooler (RS232/1, 2, 3 or 4 of PL/1 or 2) and presses B for baud rate from 110 to 9600.

The user can set the screen color of preference and also put it in Grand RAM, he notes. The configurations for color and the CRU base can be saved to disk and accessed to load into Grand RAM.

Moseid notes that if there is more than one Grand RAM in the system, only one

can do print spooling and Hot Keys. It is possible to operate with disks 1-9 and A-Z with this system.

The software includes source code for DSR in Grand RAM which is "well commented," Moseid says, so the user can customize it and make changes.

4A Talk and Disk Master I are being shipped out with instruction manuals on disk, he says. The 4A Talk will access disk drives 1-9 and A-Z, he notes.

For further information, contact DataBiotics, P.O. Box 1194, Palos Verdes Estates, CA 90274 or call (213) 867-0481 or (213) 925-2120.

USER NOTES—

(Continued from Page 46)

```
B(74);"!";OFF$ !234
290 FOR I=1 TO 4 :: PRINT #1
:VLINES$ :: NEXT I :: PRINT #
1:ON$ !147
300 FOR I=1 TO 4 :: PRINT #1
: TAB(9);"!";TAB(35);N$(I);TA
B(74);"!"; :: NEXT I !062
310 PRINT #1:OFF$:WIDES$:VLIN
ES$:VLINES$:VLINES$: "-----"
;RPT$(" ",64);"-----" !052
320 FOR I=1 TO 10 :: PRINT #
```

```
1:VLINES$ :: NEXT I !054
330 PRINT #1:TAB(9);RPT$("-"
,66):: PRINT #1:"":CHR$(27);
"e": "" :: CLOSE #1 !160
340 DISPLAY AT(23,1):"ANOTHE
R? Y" :: ACCEPT AT(23,12)B
EKP SIZE(-1)VALIDATE("Yn")
:AN$ !044
350 IF AN$="" THEN 340 ELSE
IF AN$="Y" OR AN$="y" THEN 1
80 ELSE CALL CLEAR :: END !0
25
```

Disk Utilities Version 4.0

Much more than a sector editor

By HARRY BRASHEAR

Do sector editors scare you to death? Have you avoided them like the plague because you think that maybe God didn't intend you to look at a disk that way? Is a good sector editor placed somewhere at the bottom of your priority list because you can get along without it?

If your answer is yes to any of the above, I think you should at least take a cursory look at Disk Utilities. You may change your mind.

This program has been known to many as "the Birdwell sector editor," after its author John Birdwell. It has progressed to version 4.0, and I think it is about as sophisticated as a program can get.

I had always kept Disk Utilities in my Horizon RAMdisk for quick access. It never took up much room, and it was always available to force a new program to run from DSK5. You can imagine my surprise when I discovered that Ver. 4.0 took up 91 sectors. Quick investigation revealed that Ver. 4.0 includes a full disk manager built into an already fantastic utility. I wouldn't have believed it possible but, after using the program for a week, I dropped my trusty DM 1000. I'm getting ahead of myself, though, so lets start at the beginning.

The original purpose of the program was to be the easiest sector editor that could be had, and it still is. One of the best editing features of the Birdwell sector editor (BSE) is the File Editor. Most programs of this nature look at a disk as a whole item, starting at sector zero and ending at whatever maximum format you are using. You have to know where a certain file begins on the disk to go to it via a sector number. The BSE will ask for a file name first, if you select that option, and go find it. The first sector is displayed on the screen in either hex (CTRL H) or ASCII (CTRL A), and you have full screen cursor control to get around the bytes. As the cursor moves, the byte number it's on is displayed at the bottom of the screen in both hex and decimal. You just can't get lost. If you change something in the sector, the new characters are viewed in inverse color so there is no mistake about where you have made

Report Card

Performance.....A
Ease of Use.....A+
Documentation.....A
Value.....A
Final Grade.....A
Cost: \$15

Manufacturer: John Birdwell, 7052 Springhill Circle, Eden Prairie, MN 55344

Requirements: memory expansion, disk system, Extended BASIC or Editor/Assembler, printer optional

changes. CTRL W writes the sector back to the disk where it came from, or to a new location if you wish. CTRL N will send you to the next sector or CTRL B will back up to a preceding one. How easy can it be?

If you have any experience with such editors, you probably won't need to do much reading in this section of the documentation. I should say that the standard edit format of starting from sector zero on the disk is also available, and just as easy.

Now to the good stuff!

Lets look at the main menu:

- 1) File Utilities
- 2) Disk Manager
- 3) Disk Utilities
- 4) Sector Utilities
- 5) System Setup
- 6) Exit

1. File Utilities will take you to the following menu:

- 1) File Ops
- 2) File Recover
- 3) File Report
- 4) File Editor
- 5) Find String
- 6) File Compare
- 7) File Print

File Options looks a bit like DM 1000, only better. Let's look at some standard items, such as "C" for copy. (You enter the letters down the left side the same as DM 1000.) When you press "C," the cursor launches itself to the far right side where the file name duplicates itself. If you

want to change the file name on the copy, you do it here, not over the original name, otherwise you just Enter. You're killing two birdwells with one stone that way, so to speak.

"D" is for delete, "U" and "P" are for unprotect and protect, but you don't have to go to the right-most column to do that as in DM 1000. "R" is for renaming the current file. Remember the Copy rename just changes it on the destination disk, not the original.

Pressing "V" will allow you to scan through a D/V or D/F 80 file and, again, something has been added. Instead of going one screen of text at a time, the scroll is continuous and the space bar stops and starts it. The program also keeps track of the number of lines in the text file you are looking at.

If you press "A" for All, all of the files get copied one by one, a very handy feature. Another cute feature is the ability to override that eternal nuisance, "Destination File is Protected," CRASH! The program will give you this message and ask if you wish to continue. If so, it overrides the protection and copies the file over the old protected one. I love it! You can also Move Files.

By the way, for you Myarc fans, the program can be used to initialize in quad-density if you like. And if you have RAM-disks, it will handle up to nine drives.

You can Retrieve deleted files the same as you do in DM 1000, as long as they haven't been overwritten.

The File Report looks at the disk and reports on the screen the size of the file, whether or not it is protected, the type, and starting and ending sector numbers. Most importantly, it will also show you where fractures occur, again naming the start and end sectors of the fracture.

The File Editor was explained above as this is (or at least, was) the main purpose of the Disk Utilities program.

Find String is another of those all important functions that BSE has made so simple a beginner can handle it. Let's say you are using an assembly language program that looks for CHARA1 in disk drive

(See Page 41)

DISK UTILITIES VERSION 4.0—

(Continued from Page 40)

one, but you need it to go to your RAM-disk No. 5. Go to the Find String area, type in the file name, the drive number it's in and then the ASCII string, "DSK1.CHARA1." The program looks through the file until it finds the string, throws the sector on the screen and highlights the string you are looking for. Then you can go in and change it to read "DSK5" and write it back to the disk.

File Compare will look at two files in different drives and check them one sector at a time. If it finds a difference, it will tell you the sectors that are different on the screen or print them out for you.

File Print will dump the entire file to your printer in hex and ASCII. It should also be noted that all functions of this nature will also dump to a disk file if requested.

Next on the main menu is 2) Disk Manager. This leads you to a new menu of five functions:

- 1) Initialize Disk
- 2) Copy (Backup)
- 3) Validate Disk
- 4) Rename Disk
- 5) Set Up Myarc RAM Disk

Initializing a disk, for the most part, is pretty much the same as any disk manager, with two additional items. As noted above, it will do quad-density, and it allows you to date your disk in a 10-byte area that TI reserved for future reference.

Backing Up the disk is the only bad spot I was able to find in the whole program. Because of the size of Disk Utilities, the Read buffer is somewhat smaller than other managers, so the copying process is a little slower than I would have liked. If I want to do a whole disk copy, I usually drop out to one of the turbo copiers anyway, so this didn't bother me all that much.

Validate Disk is something we haven't had since we hung up the old Disk Manager II cartridges. It's a nondestructive verification that looks for the bad sectors, lists them and, if possible, will update the bitmap to show the shortage of sectors.

Rename Disk is the same as any other except that it can also be used to re-date the disk as well.

Myarc RAM Setup is not available to me

(and the program told me I didn't have one) so I will have to quote from the docs. "...this function allows initialization, changing the name and drive number, and the partitioning of the print buffer." Sounds interesting.

3. Disk Utilities is a whole different ballgame and consists of the following:

- 1) Disk Report
- 2) Directory/Comment
- 3) Find String
- 4) Compare Disks

In reverse order, Compare Disks and Find String are handled in the same way as they are in File Utilities, except that they do it on a full disk basis instead of just one file. Also, you are asked if you would like to Replace the string it looks for with something else of the same length.

The Directory/Comment function has always been a trademark of this editor. While you are looking at a directory of your disk on the screen you are allowed to make comments of 35 bytes in length that are stored in the last part of the file descriptor record. These comments are then printed along with a Disk Report. The report is the most comprehensive that can be had. It gives the file name, type, size in both bytes and sectors, the sector that the file descriptor is found in, and the starting and ending sectors of the file. If the file is fractured, it also shows the fractures and, of course, as mentioned above, the comments.

3. Sector Utilities only gives you two options, Edit or Print. This is where you get your full disk editing, or editing based on the sector number you wish to work on.

Printing will dump the sectors "from/to" to your printer in condensed mode in both the hex and ASCII format.

4. System Setup is where you tell the BSE just what you have and how you want it done. You can lay in the following information on a one time basis or, if you like, Birdwell has set up a directory of the sectors of his program that the information can be changed in permanently. The sector map is included in the docs, with the changes that must be made for color, printer ports, commands, etc.

Printer Setups:

A) The printer default is PIO for Epson protocols.

B) Do you want form feeds after printout.

C) The type of printout, hex and ASCII next to each other or one over the other.

D) Compressed or standard print for the dumps.

Screen Colors: (foreground/background).

Maximum Number of Drives: up to nine.

There you have it, the Birdwell Sector Editor or, properly named, Disk Utilities. I know there have been other programs over the years that have done the same things, but they have never been done better or more easily.

Birdwell distributes a demo of this program as fairware but to be a registered user and get the whole thing it will cost you \$15.

Don't waste your time with the demo, go for the real thing!

Reader to reader

Keith Bergman (653 1/2 Fair Ave. N.W., New Philadelphia, OH 44633) is interested in anything about telecommunications (suggestions for good terminal programs, good BBS numbers, etc.) Also, he would like to start his own BBS eventually and would like information on that as well.

Bill Harms, 6527 Hayes Court, Chino, CA 91710, wants to hear from anyone who knows how to dump Logo screens to a printer.

Russ Stanton, 920 Twin Bridges Rd. #112, Alexandria, LA 71303, wants a way

to transfer data in Scott Adams games from cassette to diskette without using the Tunnels of Doom module.

Michael Rittweger, Nissenstr. 12, D - 2300 Kiel 14, West Germany, offers his help in graphics and in utilities, especially routines in assembly and BASIC, to anyone who wants to write him. He says by doing so he hopes to make contacts that help him practice English.

Walter Sharritts of 1201 W. Cornell St. #116, Avon Park, FL 33825, says he
(See Page 42)

Newsbytes

Third TI Fest set by Ottawa group

The Ottawa TI99/4A Users' Group is hosting the third annual Canadian TI Fest from 9 a.m. to 5:30 p.m. March 5 at Merivale High School, 1755 Merivale Rd., Nepean, Ontario (in the greater Ottawa area).

Jane Laflamme of the users' group says that they hope Barry Traver of Genial Computerware in Philadelphia, Pennsylvania, will participate and that all user groups are invited to participate as well as vendors.

A hospitality suite for out-of-town guests will be arranged for the evening of March 4, she says, and a banquet will be held after the Fest March 5.

For more information, contact Laflamme at 6480 Canotek Rd., Unit 16, Gloucester, Ontario, Canada K1J 9H6 or (613) 837-1719 (home) or (613) 745-2225 (work).

Third TICOFF near

The third annual TICOFF, the East Coast Computer Show, will be held at Roselle Park High School, Roselle Park, New Jersey, March 26.

TICOFF '88, a nonprofit venture, is sponsored by the student council of the high school along with seven TI99/4A and IBM user groups in New Jersey, New York and Pennsylvania.

The show will feature presentations, seminars, product displays of software and hardware of TI and IBM vendors, and vendors of general computer merchandise.

All vendors can be accommodated, according to vendor coordinator Dennis Porpora, but locations and the limited electrical services are on a "first come, first served" basis.

Vendor fees are \$50 for the first table, \$35 for the second table and \$25 per table for additional tables.

Roselle Park High School is located at exit 137 of the Garden State Parkway. Proceeds from TICOFF '88 will go to the student council's scholarship fund.

For further information, contact TICOFF '88, c/o Roselle Park High School, 185 West Webster Ave., Roselle Park, NJ 07204 or call Robert Guellnitz at (201) 241-4550 or 241-8902 or Porpora at (201) 696-0816.

Disks designed for blind users

Labels for discs and packaging that enable a blind person to read the contents of the package and the description of the discs in Braille was scheduled for release in early February by Brown Disc of Colorado Springs, Colorado.

The design was developed through the assistance of Dr. Dean Tuttle of the University of Northern Colorado and Michael Piet, supervising teacher at the Colorado State School for the Deaf and Blind.

Each box containing 10 diskettes gives, in Braille, the technical description of the contents of the box. Inside the box, each diskette is labelled in Braille with a technical description of that particular floppy disc. Inside each box is a label kit designed so the user can create in Braille specific information concerning individual diskettes that contain applications software and programs.

For further information, contact Brown Disc, 1110 Chapel Hills Dr., Colorado Springs, CO 80920 or (303) 593-1015.

New England Fayuh scheduled April 9

The third annual New England TI99 Fayuh, will be held from 10 a.m. to 5 p.m. April 9 at the Diamond Junior High School in Lexington, Massachusetts, sponsored by the Boston Computer Society.

According to Walt Howe of the BCS, among the TI notables expected in attendance are Scott Darling, Tom Freeman and Terrie Masters from the west coast and Mike Dodd from Tennessee.

Newsletter for users of EZ-Keys

Asgard Software has begun publishing *Key Notes*, described as a quarterly journal devoted to owners of its EZ-Keys program.

The first two issues will be free to purchasers of EZ-Keys, according to Chris Bobbitt of Asgard Software. He says that at the end of six months the company will examine costs to determine whether to continue free or paid circulation for the

publication.

For further information, contact Asgard Software, P.O. Box 10306, Rockville, MD 20850.

Dutch users group has new address

The new address for the TI Gebruikers Groep of The Netherlands is c/o Erik van Wette, Kremersmaten 106, 7511 LC Enschede, The Netherlands. Phone is 01131 53 317118.

Van Wette says that the group has 800 members and publishes a magazine, *Tljinigen*, every two months.

Newsbytes is a column of general information about products and services related to TI and 9640 users. The publisher does not necessarily endorse products listed in this column. Vendors, manufacturers and others are encouraged to submit items for consideration. Photos will be used when space permits. Materials cannot be returned. Send materials to: MICROpendium Newsbytes, P.O. Box 1343, Round Rock, TX 78680.

Reader to reader

(Continued from Page 41)

would like to contact other TI users to share knowledge in the Avon Park-Sebring-Lake Placid-Watchula area.

The Reader to Reader column is designed to put readers in touch with each other. Anyone with a specific problem or question that may be answered by other readers is encouraged to submit an item. Be sure to address it to Reader to Reader, c/o MICROpendium, P.O. Box 1343, Round Rock, TX 78680.

Coming next month

- Review of String Master
- Review of PC Transfer
- Universal file read program
- Tips on using the HRD+ or Horizon on the 9640

User Notes

Fake out the CC 9900

This comes from Luke Lester, of Jolo, West Virginia. It is of interest to users of the CorComp 9900 mini-expansion box. He writes:

Don't you hate it when you plug in your game of Video Chess, Buck Rogers, etc. or some other cartridge and you select its number and your screen just doesn't look right? Some times the game won't even run. Well, I've found a way around right in the back of the CorComp 9900 manual. It returns you to the TI title screen. Here's how:

1. Plug the cartridge into the console with the CorComp menu on the screen.
2. Select TI BASIC and load the program listed below. Then run it.
3. Then the program will wait for you to enter.
4. Next thing you know, you're back to the TI screen. And your cartridges should run normally.
5. To return to the CorComp menu screen, turn off the computer and turn it back on.

There are some disadvantages to this, of course. You can't save or load a disk program. So you can't use any call links. But it does seem to use the 32K memory expansion and the CALL LOADS.

```
10 CALL CLEAR
20 INPUT "TO RETURN TO THE COR
COMP SCREEN TURN OFF COMP
UTER FOR FIVE SECONDS":A$
30 CALL EXEC(36)
```

Clarification on Checksum

This is from Elton Schooling, of Sacramento, California.

What Tom Freeman intended to say, and did say in fragments throughout his article about his marvelous two-part program (You can be sure with checksum, October 1987) was the way to use it. In case some of us couldn't get it all together — it took me several hours and we may not all be so patient — it goes something like this:

First, with 32K and disk drive connected, type in your program (or load from disk) using XBASIC, and SAVE it with

```
MERGE (SAVE DSK1.YRPROGRAM,
MERGE).
```

Second, put the CALL LOAD ("Check") part of the program into the disk drive and type:
CALL INIT :: CALL LOAD("CHECK")
:: CALL LINK("CURSOR")
and Enter. This loads the assembly language part. You may get an error message here: mine was "I/O ERROR 00." Evidently not a fatal error; I ignored it and everything worked just fine.

Third, load the XBASIC part of the program, "Checksum," but don't run it yet.

Fourth, put your disk, with YRPROGRAM in MERGE format on it, into the disk drive, and now type RUN.

Fifth, follow the screen instructions. For the input MERGE program write DSK1.YRPROGRAM, and for the output MERGE program write DSK1.YRPROGRAM1, or at least something different from the input name, or it crashes. The latter program will have the checksums on it, for comparison with the published version.

A warning: If in YRPROGRAM you didn't put spaces in the same places as in the published version, you may get a different checksum. The line may look okay. If the checksum difference is just 32 or a multiple of 32, as 64 or 96, look at the spaces. The ASCII number for a space is 32.

Label printer and Seikosha GP100

James W. Wiegand, of Ridgeley, West Virginia, writes:

The program in the December 1987 issue titled "Labels with impact" is very useful. In its present form, however, it is not compatible with the Axiom Seikosha GP100/TI printer. The following modifications will provide the handy labels to owners of this printer.

Change lines 10-80, 220, 250-320, 340, 350, 440 and 450-480 to read as below.

Add lines 435, 437, 455 and 457.

Delete lines 90, 100-150, 170, 180 and 400.

```
10 ! ***** !19
3
20 ! * PRINT A TAG * !16
1
```

```
30 ! * BY * !11
4
40 ! * ED MACHONIS * !17
8
50 ! * MODIFIED BY * !17
9
60 ! * JIM WIEGAND * !18
2
70 ! * FOR GP100/TI * !14
6
80 ! ***** !19
3
160 OPEN #1: "PIO.CR" :: B=1
!063
190 DISPLAY AT(1,3)ERASE ALL
:"*** PRINT A TAG ***" !
188
220 DISPLAY AT(6,1): "CHOOSE
BORDER: ":"1=CHECKED BLK", "5=
WALKER", "2=XMAS TREE", "6= $
$ $ $", "3=HEART ", "7= * * *
*", "4=MUSIC NOTE", "8=HAPPY F
ACE" !067
250 B$=RPT$(CHR$(170),2)&RPT
$(CHR$(85),2)&RPT$(CHR$(170)
,2):: GOTO 330 !106
260 B$=CHR$(48)&CHR$(28)&CHR
$(255)&CHR$(255)&CHR$(28)&CH
R$(48):: GOTO 330 !XMAS TREE
!024
270 B$=CHR$(28)&CHR$(63)&CHR
$(254)&CHR$(254)&CHR$(63)&CH
R$(28):: GOTO 330 !HEART !25
1
280 B$=CHR$(96)&CHR$(240)&CH
R$(255)&CHR$(1)&CHR$(6)&CHR$(
12):: GOTO 330 !MUSIC NOTE
!235
290 B$=CHR$(136)&CHR$(107)&C
HR$(31)&CHR$(43)&CHR$(72)&CH
R$(132):: GOTO 330 !WALKER !
110
300 B$=CHR$(36)&CHR$(74)&CHR
$(255)&CHR$(255)&CHR$(82)&CH
R$(36):: GOTO 330 !DOLLAR SI
GN !153
310 B$=CHR$(108)&CHR$(56)&CH
R$(254)&CHR$(254)&CHR$(56)&C
HR$(108):: GOTO 330 !ASTERIS
K !081
320 B$=CHR$(60)&CHR$(82)&CHR
$(169)&CHR$(169)&CHR$(82)&CH
R$(60):: GOTO 330 !HAPPY FAC
E !060
```

(See Page 44)

User Notes

(Continued from Page 43)

```

340 RR$=RPT$(" ",(11-LEN(R$)
)/2)&R$&RPT$(" ",(12-LEN(R$)
)/2)!227
350 N$=CHR$(14)&RR$&CHR$(15)
!077
435 PRINT #1:CHR$(27);"W";CH
R$(141);B$!003
437 C$=CHR$(141)&" " !105
440 PRINT #1:RPT$(C$,4);DD$;
RPT$(C$,4);CHR$(13);CHR$(10)
!109
450 PRINT #1:C$;"TO:";N$;"
";C$;CHR$(13);CHR$(10)!112
455 PRINT #1:CHR$(27);"W";CH
R$(143);!159
457 PRINT #1:CHR$(28);CHR$(6
3);CHR$(254);CHR$(254);CHR$(
63);CHR$(28)!248
460 PRINT #1:C$;" WITH "
;CHR$(143);" LOVE ";CHR$(143
);" FROM ";C$;CHR$(13)
;CHR$(10)!248
470 PRINT #1:C$;G$;C$;CHR$(
13);CHR$(10)!119
480 PRINT #1:RPT$(C$,10);RPT
$(C$,7);CHR$(13);CHR$(10)!06
2

```

And for impact

And here's advice for use of the label printer by those with a TI impact printer from John F. Cline, of Washington, Pennsylvania. He writes:

Some changes must be made for the program to work properly with the TI printer and a serial interface. First, you must be in full graphics mode by setting the DIP switch SW2-1 to the off position, 8 bit word length. The device name must then be changed in 160 to read:

```
160 OPEN #1:"RS232.BA=4800.CR.D
A=8" :: PRINT #1:CHR$(27);"E";C
HR$(27);"G"
```

Also, to print enlarged characters, line 350 must be changed to read:

```
350 N$=CHR$(14)&RR$&CHR$(20)
```

Calculator adds up

Although it doesn't output its numbers to a roll of paper, Calculator does just about everything else a hand-held

calculator does. Chuck Reinhart and Paul Dumesnil, of Bellaire, New York teamed up to write this Extended BASIC program, which requires an expansion memory.

The program uses a CALL LINK assembly language routine to speed up the keyboard. Functions are similar to a calculator. The major keys require only a single key. For example: M equals minus, P equals plus, D equals divide by, and so on.

The percent key works in three ways: Percent times a number equals result; Number plus percent equals result; Number minus percent equals result.

When entering lines that are extremely long, type until the computer will accept no more data. Press Enter. Then press FCTN REDO. The line will reappear and you will be able to add more characters.

```
100 REM CALCULATOR by CHUCK
REINHART and PAUL DUMESNIL !
208
```

```
110 CALL INIT :: CALL LOAD(1
6376,68,83,80,76,89,32,37,34
)!038
```

```
120 CALL LOAD(8194,37,122,63
,248)!148
```

```
130 CALL LOAD(9460,0,0,0,1,3
7,20,0,0,0,78,0,0,203,20,203
,53,203,78,203,231,204,71)!0
93
```

```
140 CALL LOAD(9482,204,150,2
04,228,205,29,205,75,205,96,
255,255,35,253,38,184,40,183
,41,182,42,195)!021
```

```
150 CALL LOAD(9504,43,193,2,
224,36,244,2,4,0,78,4,192,2,
1,0,1,2,2,37,20,7,32)!128
```

```
160 CALL LOAD(9526,37,20,4,3
2,32,20,4,197,192,194,209,11
5,6,197,2,6,96,0,2,2,0,12)!1
49
```

```
170 CALL LOAD(9548,96,133,19
2,4,2,8,32,32,208,72,176,70,
4,32,32,32,5,132,6,2,22,246)
!001
```

```
180 CALL LOAD(9570,192,4,208
,115,176,70,4,32,32,32,5,132
,6,5,22,248,2,224,131,224,4,
96,0,112,69,79)!041
```

```
190 CALL CLEAR :: CALL SCREE
N(13):: FOR E=1 TO 8 :: CALL
COLOR(E,2,12):: NEXT E :: C
```

```
ALL,COLOR(9,13,13):: CALL VC
HAR(1,31,96,96):: FOR E=1 TO
6 :: READ D,V$ :: CALL CHAR
(D,V$):: NEXT E !131
```

```
200 DATA 62,"000000000018180
0",136,"FFFFFFFFFFFFFFFF",12
8,"001000FE00100000",129,"00
00007E007E0000",137,"0000000
000000000",104,"080C0E0F0F0E
0C08" !219
```

```
210 DISPLAY AT(3,2):"TOTAL--
--)": : "MEMORY---)": : "FUNC
TIONS": : "PLUS---)P": "MINUS
---)M": "TIMES---)T": "DIVIDE-
-)D": "PERCENT-)%": : B,C=16
!236
```

```
220 DISPLAY AT(14,1):"CLEAR-
---)C": "CL-MEM---)/": "ADD MEM-
)+": "SUB MEM-)-": "EQUALS---)E
" :: C$=" " 0" :: C
ALL,COLOR(13,2,12,10,16,7)!1
88
```

```
230 CALL COLOR(14,15,7,3,2,1
6,4,2,16):: CALL HCHAR(1,14,
136,14):: CALL HCHAR(18,14,1
36,14):: CALL VCHAR(2,14,136
,16)!167
```

```
240 CALL VCHAR(2,27,136,16):
: FOR D=2 TO 17 :: CALL HCHA
R(D,15,137,12):: NEXT D :: D
ISPLAY AT(3,13)SIZE(12):C$
:: DISPLAY AT(5,13)SIZE(12):
C$ !211
```

```
250 DATA 16,55,18,56,20,57,2
2,128,24,67,25,77,16,52,18,5
3,20,54,22,88,24,82,25,77,16
,49,18,50,20,51 !238
```

```
260 DATA 22,45,24,77,25,45,1
6,48,18,62,20,129,22,43,24,7
7,25,43,24,67,25,69,22,67,20
,37,23,47,23,47 !237
```

```
270 FOR D=8 TO 16 STEP 2 ::
FOR E=1 TO 6 :: READ R,Q ::
CALL HCHAR(D,R,Q):: NEXT E :
: NEXT D :: C$="ENTER AMOUNT
)" :: G$=" MULTIPLY BY )"
!159
```

```
280 DISPLAY AT(20,1):C$ :: D
ISPLAY AT(3,13)SIZE(12):C$
!064
```

```
290 CALL KY(M,K,N):: IF K=47
OR K<46 OR K>57 THEN 320 !1
81
```

```
300 DISPLAY AT(20,1):"ENTER
```

(See Page 45)

User Notes

(Continued from Page 44)

```

FUNCTION )" :: CALL HCHAR(B,
C, 138)!194
310 CALL KEY(O,K,R):: IF R=0
THEN 310 !207
320 F=3 :: CALL HCHAR(B,C,13
8):: B=12 :: C=21 :: IF K=80
THEN B=14 :: V$=O$ :: GOSUB
420 :: D=1 :: GOTO 290 !166
330 IF K=77 THEN V$="SUBTRAC
T BY )" :: GOSUB 420 :: D=2
:: GOTO 290 ELSE IF K=84 TH
EN B=10 :: V$=Q$ :: GOSUB 42
0 :: D=3 :: GOTO 290 !049
340 IF K=68 THEN B=8 :: V$="
DIVIDE BY )" :: GOSUB 420
:: D=4 :: GOTO 290 !010
350 IF K=67 THEN B=16 :: GOS
UB 410 :: DISPLAY AT(3,13)SI
ZE(12):CA$ :: CALL HCHAR(B,C
,138):: IF M>0 THEN N=0 :: G
OTO 280 ELSE D,H,M,N=0 :: GO
TO 280 !112
360 B=14 :: IF K=69 THEN C=1
9 :: E=1 :: GOSUB 410 :: GOS
UB 430 :: M=0 :: GOTO 300 EL
SE C=23 :: F=5 !130
370 IF K=43 THEN GOSUB 410 :
: K,I=I+N :: GOSUB 400 :: GO
TO 300 ELSE IF K=45 THEN B=1
2 :: GOSUB 410 :: K,I=I-N ::
GOSUB 400 :: GOTO 300 !101
380 F=3 :: IF K=47 THEN B=8
:: GOSUB 410 :: I=0 :: DISPL
AY AT(5,13)SIZE(12):CA$ :: C
ALL HCHAR(B,C,138):: GOTO 29
0 !043
390 IF K=37 THEN B=16 :: C=1
9 :: GOSUB 410 :: N=H :: M=N
*M/100 :: IF D=3 THEN K,N=M
:: GOSUB 400 :: GOTO 300 EL
SE GOSUB 430 :: GOTO 300 ELSE
310 !018
400 V$=STR$(K):: Q=LEN(V$)::
R=25-Q :: DISPLAY AT(F,13)S
IZE(12):CA$ :: DISPLAY AT(F,
R)SIZE(Q):V$ :: RETURN !038
410 CALL HCHAR(B,C,104):: RE
TURN !146
420 GOSUB 410 :: DISPLAY AT(
20,1):V$ :: IF D=0 THEN H=M
:: K=N :: GOTO 400 !179
430 IF M=0 AND E<>1 THEN RET
URN ELSE K=N :: IF D=1 THEN
H=H+M ELSE IF D=2 THEN H=H-M

```

```

ELSE IF D=3 THEN H=H*M ELSE
IF D=4 THEN H=H/M ELSE IF D
=9 THEN 400 ELSE H=M :: GOTO
400 !155
440 K,N=H :: IF E=1 THEN E=0
:: D=9 :: GOTO 400 ELSE 400
!196
450 SUB KY(M,K,N):: EA$="" :
: M=0 :: FOR J=1 TO 11 !236
460 CALL KEY(O,K,O):: IF O<>
0 THEN 460 !202
470 CALL KEY(O,K,O):: IF O=0
THEN 470 :: IF K=47 OR K<46
OR K>57 THEN 490 ELSE EA$=E
A$&CHR$(K):: IF K=46 AND M=0
THEN N=0.0 ELSE M=VAL(EA$):
: N=M !246
480 CALL LINK("DSPLY",EA$)::
NEXT J !027
490 SUBEND !168

```

Cable extends Widget from console

Arthur Hazboun, of Harbor City, California, has improved on the Navarone Widget by disconnecting it from the GROM port, so to speak. Instead of plugging the Widget directly into the port (which can be a nuisance when typing), he has fabricated a cable that plugs into the port and is then attached to the Widget. Readers are advised that hardware modifications are done at their own risk and the author or MICROpendium cannot be held responsible for the results. He writes:

This idea was inspired and invented by Ken Hamai of the Brea Users Group in California.

First, you will need a TI cartridge with
(See Page 46)

Installing XBII+ in the console

The December 1987 issue carried a User Note by Chuck Reinhart detailing a method of installing TI Extended BASIC chip into the console. John Barto, of Glendale, Arizona, offers this suggestion to install Mechatronic Extended BASIC II+ into the console instead. Remember, neither MICROpendium nor the authors can take any responsibility for the success or failure of this or any hardware project.

You'll need to follow the instructions from Reinhart's guidelines, except that instead of using a DPDT mini switch you'll need a TPDT switch. This will disable the GROM chip select in the cartridge. Otherwise, the Mechatronic cartridge will not allow any other cartridge to function in the console.

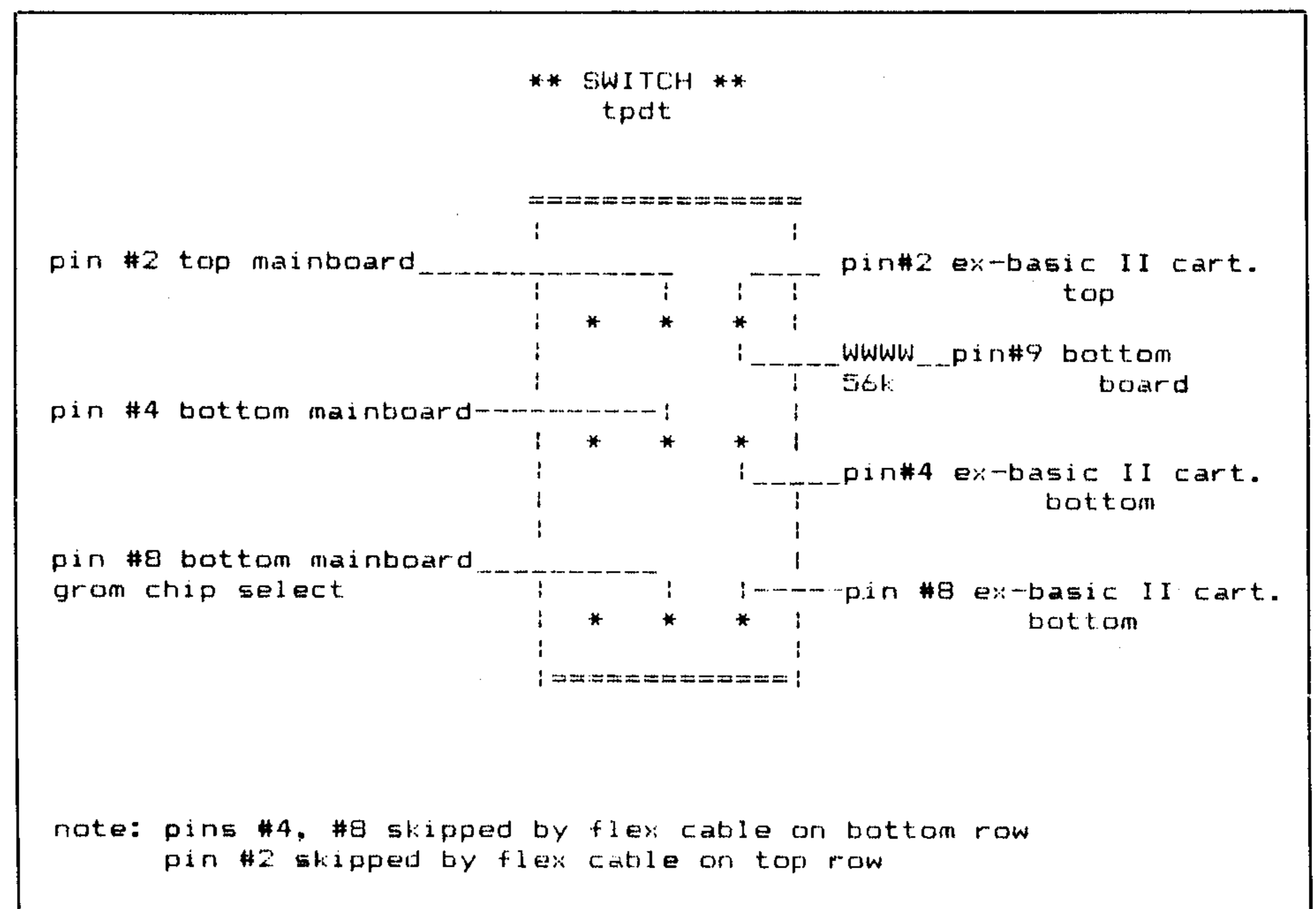

User Notes

(Continued from Page 45)

dual contacts on it (such as Munchman, Microsurgeon, etc.). Make sure this is an extra cartridge that you do not need because you will not be able to use it again for its original purpose.

Second, obtain a 36-pin female card edge connector and enough 36-pin ribbon cable for your needs (3-6 feet should be sufficient). If you can't find 36-pin cable, use 40-pin but eliminate pins 37-40.

Third, open the cartridge and cut all traces to the main circuit board on both sides of the cartridge. A small grinder works well. Removal of the chips is not essential, unless you feel it will give you more working room inside the cartridge.

Next, take your new edge connector and attach it to the ribbon cable making sure the No. 1 pin is oriented properly.

The chips in the cartridge are on the top side, and this is the even-numbered side for the soldering of the ribbon cable. The bottom side is the odd-numbered side. As you are looking at the way the cartridge is normally inserted into the GROM port, the bottom right edge pin location is No. 1, then 3, 5, 7, etc. The top of the cartridge has numbers 2, 4, 6, etc.

Strip the ribbon cable end for about two inches into single wire and remove about 1/4 inch of insulation from each wire. Take cable pin 1 and solder it to cartridge pin 1. Then solder 3 to 3, etc. Use a low-wattage soldering iron and check your work with a continuity tester. When you are finished with the odd-numbered side, flip it over and solder the even-numbered wires.

After the soldering, insert the cartridge-cable into the GROM port and plug the other end into the Widget.

Letter envelope design program

This is from Richard Bailey, of Gonic, New Hampshire.

I've seen an envelope addressing program that would put the addressee and return addresses on a regular envelope, but why stop there? The accompanying program will produce letter-size (3 3/4 x 6 1/2 inch) envelope blanks that you can cut, fold and paste to make your own envelopes.

You are allowed up to four lines for the

addressee and your return address is automatically printed in the upper lefthand corner of the envelope. A reminder to place a 22-cent stamp in the upper righthand corner is also included. The addresses on the envelope are printed double-strike and emphasized to make a good impression. All printer codes are for Epson, but they may be modified for use with other printers.

PROGRAM NOTES

Line 170 defines the vertical fold lines, 72/216-inch line spacing, emphasize and double-strike on/off.

Line 180 is screen information plus a reminder to set top-of-form.

Lines 190-210 are used to enter and edit addressee information as needed. Previous entries are accepted by pressing Enter or erased using FCTN 3.

Line 220 is the printer name.

Lines 230-330 print the envelope blank with the addresses and stamp reminder.

Lines 340-350 are used to print another envelope or exit the program.

If you set the top-of-form for the first envelope, subsequent envelopes will be correctly positioned. I use 20 lb. white or 24 lb. colored paper for envelopes.

After printing, remove the tractor strips and make the 2 1-inch horizontal cuts on each side. Fold these side tabs in along the vertical fold lines and cut along the two diagonal flap lines and the three lines for the back. Fold the back and flap along the horizontal fold lines and use a glue stick to glue the back to the side tabs.

Customizing can be done for printer names (line 220), and return address (lines 250-280). Remember to leave two spaces before each return address entry so they will be printed in the correct position, and don't change any tab settings, etc. on the end of these lines.

```

100 ! *****
!021
110 ! * LETTER ENVELOPE *
!197
120 ! * BY *
!178
130 ! * RICHARD J. BAILEY *
!162
140 ! * 68A CHURCH STREET *
!186
150 ! * GONIC, N. H. 03867 *
!013

```

```

160 ! *****
!021
170 VLINE$=" "; RPT$(
" ",64)&"!" :: WIDE$=CHR$(27
)&"3"&CHR$(72):: ONE$=CHR$(27
)&"E"&CHR$(27)&"G" :: OFF$=C
HR$(27)&"F"&CHR$(27)&"H" !00
3
180 DISPLAY AT(2,7)ERASE ALL
:"LETTER ENVELOPE":TAB(13);
BY";TAB(6);"RICHARD J. BAILE
Y": "" :TAB(6);"(SET TOP OF FO
RM)" !086
190 FOR I=1 TO 4 :: DISPLAY
AT(6+I*3,2):"ADDRESS "&STR$(
I):" "&N$(I):: ACCEPT AT(7+I
*3,2)BEEP SIZE(-27):N$(I)::
NEXT I !021
200 DISPLAY AT(23,2):"ADDRES
S O.K.? Y" :: ACCEPT AT(23
,18)BEEP SIZE(-1)VALIDATE("Y
Nyn"):AN$ !067
210 IF AN$="" THEN 200 ELSE
IF AN$="N" OR AN$="n" THEN 1
90 !033
220 OPEN #1:"PIO" ! PRINTER
NAME !005
230 FOR I=1 TO 16 :: PRINT #
1:TAB(42-2*I);"/";TAB(41+2*I
);"\" :: NEXT I !147
240 PRINT #1:" _____";RPT
$("- ",64);" _____":VLINE$;O
N$ !052
250 PRINT #1:TAB(9);"! Rich
ard J. Bailey";TAB(74);"! " !
019
260 PRINT #1:TAB(9);"! 68A
Church Street";TAB(66);"22c"
;CHR$(8);"!";TAB(76);"! " !14
9
270 PRINT #1:TAB(9);"! Goni
c, N. H. 03867";TAB(65);"STAM
P";TAB(74);"! " !245
280 PRINT #1:TAB(9);"! " ;TA
(See Page 39)

```

User Notes is a column of tips and ideas designed to help readers put their computers to better use. The information provided here comes from many sources, including TI user group newsletters. MICROpendium pays \$10 for any item sent in by readers that appears in this column. Mail User Notes to MICROpendium User Notes, P.O. Box 1343, Round Rock, TX 78680.

Classified

Software

ATTENTION TI-ARTIST USERS!

New from NAMELOC SOFTWARE: GRAPHIC LISTER! Use TI-ARTIST fonts and pics to print your *mailing list* (!), creatively and graphically on labels (1" and 1.5") or cards (3x5 or 4x6). Three separate programs written in c99 give you all the flexibility and speed you'll need. Includes LISTMAKER to build and maintain your mailing list. Also allows keyboard input for printing individual labels or cards. GRAPHIC LISTER fills a "hole" in the TI-99/4A printing world! Requires TI-ARTIST plus appropriate hardware. All this for only \$10.00 plus \$1.50 S/H! (Fully commented c99 source code, \$5 extra.) Send to:

NAMELOC SOFTWARE
3971 S.E. LINCOLN
PORTLAND, OR 97214 v5n1

Introducing ROLL CREDITS

Now a special price and a free program with your order. Video "movie" makers, give that special touch to your productions. Create professional titles with the Roll Credits title generator. Only \$8 for cassette or \$10.95 for diskette. Send SASE for details or check with your order to: Newcastle Enterprises, P.O. Box 31881-MPO288, Phoenix, AZ. 85046. v5n2

TI-99/4a SOFTWARE

We're your direct source for TI Artist, Artist's Companion, CSGD, plus more!!! All new TI Artist enhancement software now available. Free catalog. Texaments, 53 Center Street, Patchogue, NY 11772. Call (516) 475-3480 or BBS (516) 475-6464. v5n3

Magazine binders

Keep your MICROpendium collection in order and good condition with a set of plastic magazine holders. The holders fit most three-hole binders and are suitable for use with other publications.

The cost of these holders is \$3.00 for a set of 12. Shipping and handling costs are included. Please allow 3-5 weeks for delivery.

Texas residents add 7.5% sales tax. MICROpendium Holders, P.O. Box 1343, Round Rock, TX 78680.

Policy

The cost of classified advertising is 25 cents per word. Classified display (i.e., special formatting or graphics) is \$9 per column inch. Classified advertisements must be paid in advance. Classified advertisers may request a category under which they would like their advertisement to appear, but the final placement decision is the responsibility of the publisher.

Classified deadlines will be kept open for as long as practical. For the purpose of classified advertising deadlines, any classified ad received later than the first day of any month cannot be assured of placement in the next edition. We will do our best to include every advertisement that is submitted in the earliest possible edition.

The publisher offers no guarantee that any advertisement will be published in any particular issue. Any damages that result either from errors in copy or for failure to be included in any particular edition will be limited to the amount of the cost of the advertisement itself. The publisher reserves the right to reject any advertisement.

The advertiser may elect to publish the advertisement in subsequent editions at the same charge, payable prior to publication. The deadline for carryover classifieds is the same as for new advertising.

In submitting an ad, please indicate whether you would like a refund if it is not published in the requested edition or whether you would like us to hold it for the next edition. Cancellations and refunds cannot be made after the second day of the month.

Send classified advertising to: MICROpendium, P.O. Box 1343, Round Rock, TX 78680.

Software

CHECKBOOK RECONCILE \$29.95

Balance to the penny every month. Rocketman Checkbook Program. See our program review in August 1987 MICROpendium. California Programs, 4426 Appian Way, El Sobrante, Ca. 94803. 415-222-1626. v5n3

Systems

FOR SALE

- 1) TI99/4A, P-Box, TI disk controller, one SSSD drive, RS232, 32k, modem, TI Writer, Extended BASIC, software + more. \$350
- 2) TI99/4A, P-Box, CorComp disk controller, two DSDD drives, RS232, modem, printer, Myarc 512K card, Extended BASIC II, P-Code card, Forti music Synthesizer card, Gram Kracker, Trackball, Joysticks, software + more.

Systems

\$900

3) TI disk controller. \$40. Either call (317) 743-2998 or write MICHAEL LOVE; 340 S. GRANT. ST., APT. 6; W. LAFAYETTE, IN 47906. v5n1

Wanted

WANTED TO BUY

Hard disk controller, drive case and cables for Myarc WDS/100 card. Wanted M.B.X., Triple Tech, TI99/2. Need used Ext-BASIC, Archiver 2, Funnelweb, TI Count. Call (216) 793-3684 11 AM-8 PM or write L. Renda 1762 Mahoning, Youngstown, Ohio 44509. v5n1

Miscellaneous

99/4A P-CODE CARD WITH ALL DISKS AND MANUALS	\$149
PE-BOX/RS232/32K/DRIVE/CONTR	\$349
TI-WRITER NEW	\$ 29
TI ORIGINAL RS232 CARD	\$125
PARALLEL PRINTER CABLE	\$ 15
TI MULTIPLAN (NEW)	\$ 19
STAND-ALONE DISK DRIVE (NEW)	\$ 99
TI ORIGINAL 32K MEMORY CARD	\$ 99
TI ORIGINAL COLOR MONITOR	\$199
HAYES COMPATIBLE MODEM CABLE	\$ 12
FREE SHIPPING	
CALL OR WRITE	
JIM LESHER	
722 HUNTLEY	
DALLAS, TX. 75214	
214 821 9274	

v5.n1



The LEADING monthly devoted to the T199/4A



Subscription Fees
 \$20 for 12 issues via domestic second class mail
 \$25.25 (U.S. funds) Canadian or Mexican delivery
 \$23.50 (U.S. funds) for 12 issues foreign delivery via surface mail
 \$37.00 (U.S. funds) for 12 issues foreign delivery via air mail
Outside U.S., pay via postal or international money order; personal checks from non-U.S. banks will be returned

Tell us about it
 Please let us what columns or features you like the most about MICROpendium. Rank your selections in order of preference using this form. Return it to us when you renew your subscription.

1. _____
2. _____
3. _____
4. _____

Other suggestions: _____

Address Changes
 Subscribers who move may have the delivery of their most recent issue(s) delayed unless MICROpendium is notified six weeks in advance of address changes. Please include your old address as it appears on your mailing label when making an address change.

Send me the next 12 issues of MICROpendium. I am enclosing \$ _____ in a check or money order in U.S. funds. Mail to: MICROpendium, P.O. Box 1343, Round Rock, TX 78680

Name _____
Address _____
City _____
State _____ **ZIP** _____

The set of numbers on the left of your mailing label indicates the cover date of your last issue.

v5,n1

Back Issue Policy
 Back issues of MICROpendium are available to subscribers only. Those wishing back issues may notify us of the issue(s) desired and include \$2.00 per issue desired in a check or money order. No shipping charge in U.S., Canada and Mexico; Texas residents add 7.5% sales tax. For foreign delivery, add 50 cents per issue surface mail, \$2 per issue surface mail. No discounts on orders of sets. All prices U.S. funds. **OUT OF STOCK: Vol 1, nos. 1-2**

A 4/89 01 15-88 6 T
 STEPHEN A. JUSTHAM
 70 SWEETCORN DRIVE
 KILZTOWN PA 19530-9456