

---

**Covering the T199/4A EXCLUSIVELY!**

---

# MICROpendium

---

Volume 3, Number 9

October 1986

\$1.50 per copy

---



**(Keeping secrets—Page 34)**

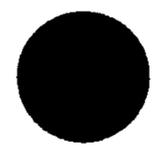

**Automatic control  
of sprites  
Page 22**

**Part II of computer  
graphics design  
Page 12**

.....Texas Instruments TI-99/4A — COMPUTERS, COMPONENTS AND SOFTWARE.....

# TEX+COMP<sup>™</sup>

America's Number One TI computer retailer  
TI-99/4 PRODUCTS AT PROFESSIONAL PRICES

The largest selection  
of software  
for the  
TI-99/4A



Tex Comp continues to stock the world's largest selection of TI Software. The TI Software library on module, disk and cassette was developed from 1979-1983 at a cost of millions and is considered the best in the home computer software field. TI utilized the talents of such industry leaders as Scott Forsman, Milton Bradley, Microsoft Corp., Scott Adams, Addison Wesley Publishing, DLM, Milliken Publishing, Scholastic Inc., Imagic, Spinnaker and the list goes on and on.

## SPECIAL OFFER

Brand New Original Black & Silver TI-99/4A console only \$79.95. Runs all third party modules and comes with 1 year TI factory warranty.  
\*Shipping, handling & insurance on this special offer is \$10.00 (Continental U.S.) to any UPS deliverable address. HA, AL, Canada and APO slightly higher.

## MANAGEMENT

<b>INFORMATION MANAGEMENT MODULES</b>	
PHM 3006	Home Financial Decisions..... 4.95
PHM 3007	Household Budget Mgt..... 4.95
PHM 3012	Securities Analysis..... 19.95
PHM 3013	Personal Record Keeping..... 15.95
PHM 3016	Tax/Inves Rec Keep (Disk Req.)..... 4.95
PHM 3022	Personal Real Estate..... 4.95
PHM 3044	Personal Report Generator..... 10.95
PHM 3035	Terminal Emulator II..... 9.95
PHM 3111	TI Writer (word processing)..... 38.75
PHM 3113	Multiplan (spreadsheet)..... 38.95

<b>DISKETTE PROGRAMS</b>	
PHD 5001	Mailing List (PIO Upgrade)..... 12.95
PHD 5003	Personal Financial Aids..... 9.95
PHD 5021	Checkbook Manager..... 9.95
PHD 5022	Finance Manager..... 19.95
PHD 5024	Inventory Management..... 19.95
PHD 5027	Invoice Management..... 19.95
PHD 5029	Cash Management..... 19.95
PHD 5038	Lease/Purchase Decisions..... 9.95
PHD 5075	TI Writer/Multiplan Upgrade..... 9.95

<b>CASSETTE PROGRAMS</b>	
PHT 6003	Personal Financial Aids..... 9.95
PHT 6038	Lease/Purchase Decisions..... 9.95

## EDUCATION

<b>MODULES</b>	
PHM 3002	Early Learning Fun..... 4.95
PHM 3003	Beginning Grammar..... 4.95
PHM 3004	Number Magic..... 4.95
PHM 3008	Video Chess..... 14.95
PHM 3010	Physical Fitness..... 9.95
PHM 3020	Music Maker..... 9.95
PHM 3021	Weight Control & Nutrition..... 10.95
PHM 3084	Touch Typing Tutor..... 10.95

PHM 3109	TI Logo II (32K req.)..... 19.95
PHM 3015	Early Reading (Speech)..... 9.95
PHM 3043	Reading Fun..... 9.95
PHM 3046	Reading On..... 9.95
PHM 3047	Reading Roundup..... 9.95
PHM 3048	Reading Rally..... 9.95
PHM 3082	Reading Flight..... 9.95
PHM 3027	Addition & Subtraction I..... 9.95
PHM 3028	Addition & Subtraction II..... 9.95
PHM 3029	Multiplication I..... 9.95
PHM 3049	Division I..... 9.95
PHM 3050	Numeration I..... 9.95
PHM 3051	Numeration II..... 9.95
PHM 3059	Scholastic Spelling 3..... 9.95
PHM 3080	Scholastic Spelling 4..... 9.95
PHM 3081	Scholastic Spelling 5..... 9.95
PHM 3082	Scholastic Spelling 6..... 9.95
PHM 3088	Computer Math Games VI..... 9.95
PHM 3090	Milliken Addition..... 9.95
PHM 3091	Milliken Subtraction..... 9.95
PHM 3092	Milliken Multiplication..... 9.95
PHM 3093	Milliken Division..... 9.95
PHM 3094	Milliken Integers..... 9.95
PHM 3098	Milliken Number Readiness..... 4.95
PHM 3099	Milliken Laws of Arithmetic..... 4.95
PHM 3100	Milliken Equations..... 4.95
PHM 3101	Milliken Meas of Formulas..... 4.95
PHM 3114	Alligator Mix..... 6.95
PHM 3115	Alien Addition..... 6.95
PHM 3117	Dragon Mix..... 8.95
PHM 3118	Minus Mission..... 6.95
PHM 3119	Meteor Multiplication..... 6.95
PHM 3177	Face Maker..... 9.95
PHM 3178	Story Machine..... 9.95

## DISKETTE PROGRAMS

PHD 5009	Music Skills Trainer..... 9.95
PHD 5018	Market Simulation..... 9.95
PHD 5030	Speak & Spell (Speech Ed Req.)..... 9.95
PHD 5031	Speak & Math (TE II Req.)..... 9.95
PHD 5042	Spell Writer (TE II Req.)..... 9.95
PHD 5026	Bridge Bidding I..... 9.95
PHD 5039	Bridge Bidding II..... 9.95
PHD 5041	Bridge Bidding III..... 9.95
PHD 5020	Music Maker Demo (Module Req.)..... 9.95

## CASSETTE PROGRAMS

See disk versions for requirements i.e. TEII	
PHT 6009	Music Skills Trainer..... 8.95
PHT 6011	Computer Music Box..... 8.95
PHT 6018	Market Simulation..... 8.95
PHT 6031	Speak & Math..... 9.95
PHT 6042	Spell Writer..... 9.95
PHT 6026	Bridge Bidding I..... 9.95
PHT 6039	Bridge Bidding II..... 9.95
PHT 6041	Bridge Bidding III..... 9.95

## BRIGHT BEGINNINGS SERIES

PHM 3154	Terry Turtle's Adventure (MBX Expansion System Required)..... 9.95
PHM 3155	I'm Hiding (MBX Expansion System Required)..... 9.95

## ARCADE PLUS SERIES

PHM 3148	Championship Baseball (MBX Expansion System Required)..... 9.95
PHM 3149	Space Bandit (MBX Expansion System Recommended)..... 9.95
PHM 3150	Sewermania (MBX Expansion System Recommended)..... 9.95
PHM 3151	Bigfoot (MBX Expansion System Recommended)..... 9.95
PHM 3152	Meteor Belt (MBX Expansion System Recommended)..... 9.95

## HOME ENTERTAINMENT

<b>MODULES</b>	
PHM 3009	Football..... 9.95
PHM 3018	Video Games I..... 4.95
PHM 3023	Hunt the Wumpus..... 4.95
PHM 3024	Indoor Soccer..... 8.95
PHM 3025	Mind Challengers..... 10.95
PHM 3030	Amazing..... 4.95
PHM 3052	Tombstone City..... 4.95
PHM 3053	TI Invaders..... 4.95
PHM 3054	Car Wars..... 4.95
PHM 3057	Munch Man..... 4.95
PHM 3042T	Tunnels of Doom (with cass.)..... 6.95
PHM 3042D	Tunnels of Doom (Disk)..... 6.95
PHM 3058	Alpiner..... 4.95
PHM 3110	Chisholm Trail..... 5.95
PHM 3112	Parsec..... 4.95
PHM 3031	The Attack..... 4.95
PHM 3032	Blasto..... 4.95
PHM 3033	Blackjack & Poker..... 15.95
PHM 3034	Hustle..... 6.95
PHM 3036	Zero Zap..... 8.95
PHM 3037	Hangman..... 8.95
PHM 3038	Connect Four..... 8.95
PHM 3087	Othello..... 9.95

# Texas Instruments TI-99/4A Home Computer

Tex-Comp purchased TI's inventory of these outstanding titles in order to continue its support of the TI-99/4A user, and also continually acquires inventory from leading retailers and distributors who have discontinued home computer sales.

With its five warehouses and financial resources, Tex-Comp has been able to assure you, the TI-99/4A user continued support.



PHM 3041T	Adventure & Pirate Adv. (Cass.)	6.95
PHM 3041D	Adventure & Pirate Adv. (Disk)	6.95
<b>ADVENTURE SERIES ON CASS OR DISK (SPECIFY)</b>		
	Adventureland	9.95
	Mission Impossible	9.95
	Voodoo Castle	9.95
	The Count	9.95
	Strange Odyssey	9.95
	Mystery Fun House	9.95
	Pyramid of Doom	9.95
	Ghost Town	9.95
	Savage Island I & II	9.95
	Golden Voyage	9.95
	Ironheart Adventure (Not Scott Adams)	9.95
	<b>SPECIAL ALL ABOVE ADVENTURES ON DISK OR CASSETTE INCLUDING IRONHEART</b>	<b>49.95</b>
	Buckaroo Bonzai	19.95
	Soccer of Claymorgue Castle	19.95
	Spiderman	19.95
	Hulk	19.95

<b>DISKETTE PROGRAMS</b>		
PHD 5002	TI-Trek (with new TEII Ver.)	9.95
PHD 5010	Mystery Melody	9.95
PHD 5015	Oldies But Goodies I	9.95
PHD 5017	Oldies But Goodies II	9.95
PHD 5025	Sat. Night Bingo (Speech) Ex-Basic	9.95
PHD 5037	Draw Poker (Ex-Basic Req.)	9.95

<b>CASSETTE PROGRAMS</b>		
PHT 8002	TI-Trek TE-II & Speech	9.95
PHT 8010	Mystery Melody	7.95
PHT 8015	Oldies But Goodies I	7.95
PHT 8017	Oldies But Goodies II	7.95
PHT 8026	Sat. Night Bingo (Speech) Ex-Basic	7.95
PHT 8037	Draw Poker (Ex-Basic Req.)	7.95

<b>TI ARCADE STYLE MODULES AND RECENT RELEASES</b>		
PHM 3149	Space Bandit (MBX Expansion System Recommended)	9.95
PHM 3150	Sewermania (MBX Expansion System Recommended)	9.95
PHM 3151	Bigfoot (MBX Expansion System Recommended)	9.95
PHM 3152	Meteor Belt (MBX Expansion System Recommended)	9.95
PHM 3220	Microsurgeon	9.95
PHM 3219	Super Demon Attack	9.95
PHM 3224	Moonsweeper	9.95
PHM 3145	Sneggt	5.95
PHM 3229	Hopper	4.95
PHM 3233	Burgertime	9.95
PHM 3194	Jawbreaker II	5.95
PHM 3227	Congo Bongo	15.95
PHM 3168	Treasure Island	11.95
PHM 3189	Return to Pirates Island	11.95
PHM 3228	Buck Rodgers	15.95
PHM 3225	StarTrek	15.95
PHM 3222	Fathom	9.95
PHM 3148	Munchmobile	11.95
PHM 3197	Slymoids	15.95

## COMPUTER PROGRAMMING AIDS

<b>MODULES</b>		
PHM 3028	Extended Basic & Manual	49.95
PHM 3055	Editor Assembler	19.95
PHM 3058	Mini Memory (With Writer)	38.95
<b>DISKETTE PROGRAMS</b>		
PHD 5007	Teach Yourself 99/4A Basic	9.95
PHD 5019	Teach Yourself Ex-Basic	9.95
PHD 5004	Programming Aids I	9.95
PHD 5005	Programming Aids II	9.95
PHD 5012	Programming Aids III	9.95
PHD 5077	Programming Aids I, II, & III	24.95
PHD 5087	Beginning Basic Tutor	9.95
PHD 5076	Text to Speech (English)	9.95
PHD 5098	TI Forth (Ed Assem Req.)	19.95
PHD 5078	TI Forth Demo Disk (Ed Assem)	9.95
PHD 5079	Forth Source Code (2 Disks)	11.95

<b>CASSETTE PROGRAMS</b>		
PHT 8006	Programming Aids I	6.95
PHT 8007	Teach Yourself 99/4A Basic	6.95
PHT 8019	Teach Yourself Ex-Basic	6.95
PHT 8067	Beginning Basic Tutor	6.95

## MATH AND ENGINEERING

<b>DISKETTE PROGRAMS</b>		
PHD 5006	Math Routine Library	9.95
PHD 5008	Electrical Engineering Lib.	9.95
PHD 5013	Graphing Package	9.95
PHD 5016	Structural Engineering Lib.	9.95
PHD 5044	AC Circuit Analysis	9.95

<b>CASSETTE PROGRAMS</b>		
PHT 8006	Math Routine Library	8.95
PHT 8008	Electrical Engineering Lib.	8.95
PHT 8013	Graphing Package	8.95
PHT 8016	Structural Engineering Lib.	8.95
PHT 8044	AC Circuit Analysis	8.95

## TI-COUNT SMALL BUSINESS SOFTWARE

General Ledger	69.95
Accounts Receivable	69.95
Accounts Payable	69.95
Inventory	69.95
Payroll	69.95
Mail System	39.95

**ALL 6 FOR \$349.95**

Send for New 1986 Tex-Comp catalog & buyer's guide only \$2.00 (comes with \$5 savings certificate)

### Drastic Reductions



VISA and MASTERCARD  
HOLDERS CALL DIRECT  
(818) 366-6631

add 3% for credit card orders

**TERMS:** All prices F.O.B. Los Angeles. For fastest service use cashiers check or money order. Add 3% shipping and handling (\$3.00 minimum). East of Mississippi 4 1/2%. (Free shipping on all software orders over \$100.00). Prices and availability subject to change without notice. We reserve the right to limit quantities.

SEND ORDER AND MAKE CHECKS PAYABLE TO

**TEX-COMP™**  
P.O. BOX 33084 - GRANADA HILLS, CA 91344

Texas Instruments



AUTHORIZED DEALER

**NOTE:** Payment in full must accompany all orders. Credit-Card, Company Check or Money Order for immediate shipment. Personal checks require up to 4 weeks to clear. California orders add 8 1/2% sales tax.

# Contents

## MICROpendium

MICROpendium is published 12 times annually in Round Rock, Texas. No material published in the pages of MICROpendium may be used without permission of the publisher. Computer user groups that have signed exchange agreements with MICROpendium may excerpt articles appearing in MICROpendium without prior approval.

While all efforts are directed at providing factual and true information in published articles, the publisher cannot accept responsibility for errors that appear in advertising or text appearing in MICROpendium. The inclusion of brand names in text does not constitute an endorsement of any product by the publisher. Statements published in MICROpendium which reflect erroneously on individuals, products or companies will be corrected upon contacting the publisher.

Unless the author specifies, letters will be treated as unconditionally assigned for publication, copyright purposes and use in any other publication or brochure and are subject to MICROpendium's unrestricted right to edit and comment.

Display advertising deadlines and rates are available upon request.

All correspondence should be mailed to MICROpendium at P.O. Box 1343, Round Rock, TX 78680. We cannot take responsibility for unsolicited manuscripts but will give consideration to anything sent to the above address. Manuscripts will be returned only if a self-enclosed, stamped envelope is included.

All editions of MICROpendium are mailed from the Round Rock (Texas) or Smithville (Texas) Post Office.

Mailing address: P.O. Box 1343, Round Rock, TX 78680

Telephone: (512) 255-1512

Source: TI4596

John Koloen..... Publisher

Laura Burns..... Editor

Mack McCormick.... Technical Editor

### Coming next month

—Part 3 of computer graphics design

—Mack McCormick's tutorial continues: this time he's talking about disk controllers

—John Clulow on Paolo Bagneresi's Universal GPL Loader.

## Table of Contents

### You don't have to be a physicist

The CAD series continues with a new installment on two-dimensional transformations.....Page 12

### 'Attach' a sprite to a joystick

For automatic sprite control.....Page 22

### Cryptography for the 99/4A

Your very own secret messages.....Page 34

### A freeware survey and conclusions

What a freeware author found out about other freeware authors, and what he thinks it all means.....Page 30

### Fair time

Chicago and elsewhere.....Page 36

### Reviews

TI-Forth Utilities.....Page 37

CorComp Memory Plus.....Page 39

### Newsbytes

A speech processor that converses in pig Latin, a rapid copier and a "run time" GPL Linker.....Page 40

### User Notes

Program listing length variations, even more on Wordcount, and a way to slow down DM1000.....Page 43

Classified.....Page 46



# Comments

## Regena to write BASIC column

We are more than pleased with the number of readers who indicated a desire to write a BASIC column for MICROpendium. Ironically, our new columnist didn't even apply. C. Regena, who has written TI BASIC columns for the defunct 99er Magazine and more recently Compute!, will begin publishing her columns in MICROpendium. Compute! recently abandoned coverage of the TI99/4A, which is the reason Regena was available. She will make her debut in January.

We are very flattered that she agreed to write a column for MICROpendium. Most readers should be familiar with her work in the other venues and I'm sure you'll agree with us that she will make a fine addition to our stable of writers. (We can hardly wait for January to come.)

### FREWARE SURVEY IN THIS ISSUE

This issue of MICROpendium includes a survey of Freeware authors by Jim Swedlow. The article provides some hard facts on the Freeware phenomenon, and the conclusion is that most Freeware authors, if they'd known what they were getting into at the outset, would do it again. One thing not mentioned is that MICROpendium continues to publish Freeware listings. The list is now up to 10 pages and is available for \$1, or fifty cents to those who send stamped, self-addressed return envelopes.

### WHAT'S COMING IN 1987?

My crystal ball, being cloudy, isn't of much help but I'm predicting that 1987 may be the Year of the PC as far as the TI99/4A market is concerned. Several companies are known or rumored to be involved in the production of PEB cards or other devices designed to make TI emulate a PC using a PC DOS-type operating system. Who are they? Millers Graphics is one (Millers is expected to announce a merger in January that will be accompanied by announcements or introductions of new PC-type products for TI users.) There are also rumors about similar developments in the European market, and other domestic companies may be working in

the same direction.

What does this mean for the TI user? Other than the fact that users will spend more money for PC software than TI software the question is wide open. This is new ground, folks. No one has yet taken one well-established computer system and successfully converted it into another, totally different system. While I can't think of any answers—the products haven't even been announced yet—I've got a drawer full of questions. And I'll open the drawer the day these new, mostly rumored products actually come out.

### AN OPEN LETTER TO READERS

It has become harder for readers who like to flip through pages to read about the 99/4A to do so. As you know Home Computer Journal (aka 99er Magazine, Home Computer Magazine) and Compute! no longer provide such pages for the TI99/4A, but we want to let you know that we plan to print this magazine in its support for as long as you want us to. While we are appreciative of your continuing support of MICROpendium, both in terms of kind words and contributions of articles and ideas, there's one more thing you can do for us that could result in a bigger magazine. Namely, help us expand our readership. If we could add another 2,000 readers or so we could increase the amount of space we have for articles by as many as eight pages per month. (Unlike many other magazines, we do not rely on advertising as our main source of revenue. Subscription sales are our main source, because, for one thing, we keep our advertising rates low as one incentive toward the continued production of commercial products for the TI.) If you know of a TI user who previously subscribed only to Compute! or Home Computer Journal for support, let him or her know about MICROpendium. Tell them we'll send them a sample issue free of charge if they'll just send us their name or give us a call.

As far as we're concerned, the more the merrier.

—JK

## Reviewed in MICROpendium

### 1984

**February:** B-1 Nuclear Bomber, Tandon TM-100 Disk Drive, Void, Beanstalk Adventure, Microsurgeon, On Gaming, Database 500  
**March:** Star Trek, Escape From Balthazar, Garkon's Getaway, Sky Diver, Mail-Call, Prowriter 8510 Printer  
**April:** Monthly Budget\$ Master, Budget Master, Home Budget, Thief, Donkey Kong, Khe Sanh  
**May:** Companion Word Processor, Q\*Bert, Mad-Dog I & II, Programs for the TI Home Computer  
**June:** Creative Expressions Accounts Receivable/Accounts Payable, CDC 9409 Disk Drive, Starship Concord, Lost Treasure of the Aztec, ASW Tactics II  
**July:** Theon Raiders, Introduction to Assembly Language for the TI Home Computer, Game of Wit, Pole Position  
**August:** TE-1200, Tower, Galactic Battle, Galaxy  
**September:** Wycove Forth, 99/4 Auto Spell-Check, QUICK-COPYer, Wizard's Dominion, Anchor Automation Mk XII Modem  
**October:** Killer Caterpillar, ZORK I, Defender

**November:** 9900 Disk Controller Card/Manager, Super Bugger, Transtar 120S printer, Floppy-Copy, Data Base-X  
**December:** Gravity Master, Data Base Manager System, Learning 99/4A Assembly Language Programming

### 1985

**January:** Super Sketch, Foundation Computing 128K Card, PTERM-99, TI-Runner  
**February:** Super Extended BASIC, Beginning Assembly Language for the TI, ZORK II  
**March:** Morning Star Software CP/M Card, WDS/100 Winchester Disk Drive, Sketch Mate, BMC Color Monitor  
**April:** 9900 Micro Expansion System, Disk + Aid, Gemini 10X-15X  
**May:** Character Sets and Graphics Design, Draw 'N Plot  
**June:** GRAPHX, DATA BASE I  
**July:** Acorn 99, Advanced Diagnostics  
**August:** Model Dow-4 Gazelle, TI-Artist, PC-KEYS, Not-Polyoptics' Bankroll  
**September:** Midnite Mason, Myarc 32K/128K Card, GRAPHX Companion

**October:** 4A/TALK, Extended BASIC II Plus, XB Detective, Console Writer 2.1

**November:** Foundation Z80A/80-column cards, 9900BASIC, Adventure Editor

**December:** Display Enhancement Package, Triple Tech

### 1986

**January:** BITMAC, Starcross  
**February:** Night Mission, Peripheral Diagnostic Module, BA-Writer  
**March:** Super Duper, Tunnels of Doom Editor, Business Graphs 99  
**April:** U.S. Open Tennis, PRBASE  
**May:** 4A Flyer, GRAM Kracker, Artist's Companion  
**June:** Myarc Disk Controller Card, Maximem  
**July:** Horizon RAMdisk, Old Dark Caves, Funlwriter, TI99/4A Macro Assembler  
**August:** JOYPAINT 99, GPL Assembler, TI99/4A INTERN, GPL Linker  
**September:** Mechatronic 128K card

It all began on August 17, 1985 with a unique new graphics package that startled the 99/4A world with it's fresh approach, and was hailed by MICROpendium as the best value... ever. Thus was born GRAPHX Companion.

On June 1, 1986 we again introduced a package that all the "experts" said would never make it. GRAPHX Pictures is still turning heads and showing everyone that graphics can be useful as well as beautiful.

Now introducing something so fresh and new, that you would call it simply Asgard Software's logical next step...

## GRAPHX Companion III

This package is much more than just more of the same old thing. Don't even consider the fact that it contains the largest collection of clipart to date, or that it contains a vast library of all new fonts (most of which include complete upper and lower case with numbers and symbols). All you have to remember is that it is from Asgard Software, which means (as always) that it's software with a difference.

With this package you can now make pictures that border on the magnificent with our set of imaginative borders, or you and your computer can make beautiful music together with our music symbol library, and you can even play with moving pictures with our new animation sequence. The possibilities are endless as GRAPHX Companion III will help you explore the limits of TI-99/4A graphics, and GRAPHX.

If you have GRAPHX, you will not want to be without this latest addition to our growing collection of graphics oriented software. At only \$9.00 a copy, how can you afford to be without it?

*Asgard Software*

*Box 10306*

*Rockville, MD 20850*



©1986 by Asgard Software

For information or to order call (301)345-2492 (8AM - 8PM E.S.T.)

# Feedback

## Required vertical space with TI-Writer

Reader Jim Rieger wished for a required vertical space for the TI-Writer (Feedback, July 1986).

Since TI-Writer doesn't show a formatted page, once he gets a rough draft print-out of his document, he can reload the document into the text editor and use either the "NEW PAGE" command, Control 9 or Control P, to put in a required start for a new page. Or the ".BP" format command can be used to force the beginning of a new page anywhere he wants.

If he wishes to use the moving window and 80-character line in the text editor mode, he can count his lines and put in NEW PAGE or .BP without doing a rough draft of his document.

As to having this done automatically by the program, don't I wish!

**Robert C. Clark**  
Upland, California

## Make a P.E. box!

I would like to make an observation. There are hundreds of items for the TI that anyone can buy. But, if you don't have a P.E. box, you can't take the full advantage of these products. So, why doesn't someone produce a P.E. Box? The people without one could upgrade their system and buy products like the Geneve!

**Bryan D. Turner**  
Great Bend, Kansas

## TI-Writer formatting

In response to Mr. Rieger, you may include a printer pause instruction in your files, provided you print them with the FORMATTER. The mail list option will not only stop and wait for your "go ahead" but can even prompt you for the correct print wheel, colored ribbon, hardware switch, etc.

Somewhere in your document before the point where the pause is to be made, enter a "DEFINE PROMPT" command to tell yourself what to do. You should use a mail list number (less

than 100) that isn't found anywhere else in your program. For example:

.DP 99: Insert Italic Wheel

Then, at the point where the pause is to be made, type \*99\*. When the FORMATTER sees this, it will look for a value for variable no. 99. Finding none, it will prompt you for a value using your defined prompt (if you desire) or the canned prompt contained in the FORMATTER. Change your wheel, ribbon, whatever and press ENTER to continue. Please note that if you type \*99\* with spaces on each side, your finished product will also contain two spaces, even if you chose the FILL option. You can correct this by typing \*99\* next to (or even in!) a word or phrase. For example, you could type something like:

Mary glanced at Robert and said, "*\*99\**Are you busy this weekend?*\*98\**"

In this example I am assuming \*99\* to be an italics wheel and \*98\* to be the standard wheel. Note: Each "pause" \*number\* will work only the first time it is seen in a file! After you have pressed "ENTER" for \*99\*, the FORMATTER will use this value (a null string) for every other \*99\* in your file.

Concerning the ability to send codes 127-255: most printers must be toggled into that mode. Most RS232 units default to 7 data bits and codes 127-255 would require 8 bits. Whatever the escape sequence is to toggle the printer may be sent either in FORMATTER or the EDITOR by typing the control codes in your file. First press CONTROL U, then the appropriate key(s) as outlined on page 146 of the TI-Writer manual. To exit this "command mode," press CONTROL U again. For example, to send ESC CR you would type:  
CONTROL U FUNCTION R SHIFT M CONTROL U.

**Curtis Alan Provance**  
President, New Hampshire 99er User  
Group  
Manchester, New Hampshire

## Where credit is due...

In the July issue you published a contribution by Rick Cosmano of the SCCG entitled "Changing defaults in TI-Writer describing the procedure for substituting characters other than the @ and & for overstrike and underline.

Now in the September issue you present the same information—under the title "Fix for & and @ using TI-Writer—but credited to other sources. This is a good example of a pervasive problem in the TI user community: Group newsletters and bulletin boards derive the bulk of their information from other newsletters and/or individuals but often fail to give proper credit to their source.

In this particular case, Mr. Degner does give credit to Terry Atkinson. Since Rick Cosmano furnished his article two months earlier, I believe he should be credited with this worthwhile enhancement of TI-Writer.

A note to TI-Forth enthusiasts: The @ had long been a problem during screen-to-file and file-to-screen conversions. Fortunately, the "tick" (FUNCT-C) used by Rick is not the same "tick" (FUNCT-O) as the one in Forth. However, if you have included the backslash in your word set (to denote a comment as shown in *Forth Tools* by Anita Anderson and Martin Tracy) then I would suggest that you substitute another little-used character when incorporating these changes in TI-Writer.

**Lutz Winkler**  
San Diego, California

## Unique feature of Computer War Game

Does anyone realize that the Computer War Game has a totally unique feature? This game will go back to its title screen when the CorComp load interrupt switch is pressed.

This will work for as long as the game is in the expansion box memory. Therefore, one can play the

(Please turn to Page 10)

# HOLIDAY SALE



AUTHORIZED DEALER

ON A COMPLETE COMPUTER SYSTEM

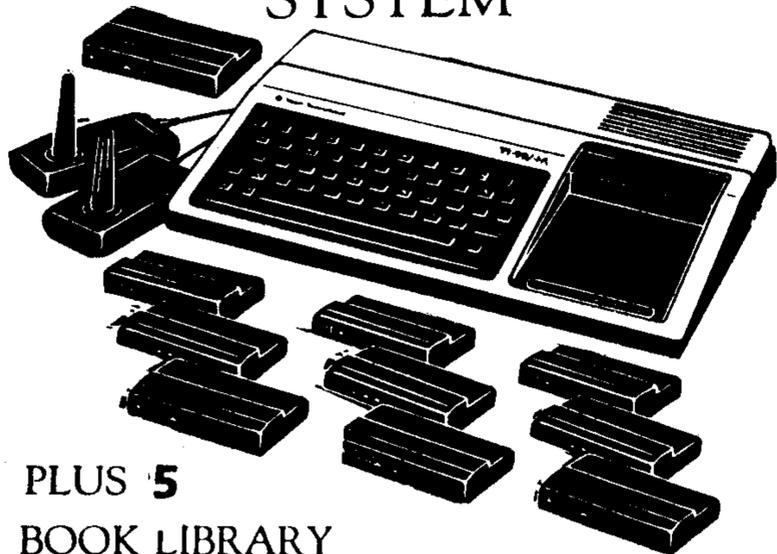

PLUS 5 BOOK LIBRARY TO START CHILDREN OF ANY AGE



THE PERFECT FAMILY GIFT

## TEX+COMP™

AMERICA'S NUMBER ONE TI COMPUTER RETAILER



Charge-it On Your Visa or MasterCard  
ORDER BY PHONE  
24 HOURS A DAY  
7 Days a Week!



### (818) 366-6631

P.O. Box 33084, Granada Hills, CA 91344

TERMS: All prices F.O.B. Los Angeles. For fastest service send cashiers check or money order. Personal checks require up to 15 days to clear. Prices reflect a 3% discount for cash or approved check. Add 3% for Credit Card orders. Prices and availability are subject to change without notice. We reserve the right to limit quantities. California orders add 6.5% sales tax.

Tex Comp, the world's largest retailer of Texas Instruments home computer products invites you and your family to join the millions of families who are already using the TI-99/4A, the most powerful and versatile home computer ever produced. There are over 1000 programs now available for the TI-99/4A including education, family financing, arcade games, word processing, data base management, and the list goes on and on. New software & accessories are being continuously introduced. Tex-Comp and Texas Instruments have put together this offer to provide your family with the opportunity to get started with a **real quality computer** instead of an underpowered game playing toy.

### YOU RECEIVE THE FOLLOWING

1. TI-99/4A Deluxe Black & Silver Computer complete with TV adaptor, power supply, users manual, programming manual and 1 year TI warranty.
2. One pair of TI Joysticks
3. 4-Volume set of Datamost books for the TI-99/4A: Kids & TI, Computer Playground TI, Elementary TI & Games TIs Play
4. Best selling book "Programs for the TI Home Computer" by Davis
5. 10 Most Popular TI Software Modules: Early Learning Fun, Physical Fitness, Amazing, Hangman, TI Invaders, Blasto, Munchman, The Attack, Tombstone City, and Home Financial Decisions
6. Cassette recorder interface cable
7. Tex-Comp TI-99/4A Catalog & Order Kit
8. \$50 Savings Certificate on future orders Purchase up to \$100 from a large selection of TI Software, Accessories and Books at 1/2 the regular price.

### ALL FOR ONLY

Your Cost

## \$99.95

\*Shipping, handling & insurance on this special offer is \$10.00 (Continental U.S.) to any UPS deliverable address. HI, AK, Canada and APO slightly higher.

Complete with a \$50 Savings Certificate for use on future purchases.



# Feedback

(Continued from Page 8)

game—then hit Function Quit—play another module-based game and then go back to Computer War instantly by pressing the load interrupt switch. This also works for Submarine Commander and River Rescue.

Wouldn't it be great to have a disk-based Disk Manager capable of being restarted so easily without reloading?

As for Mr. [John] Dow's flight simulator, sure, I would be interested in purchasing it. But I very seriously doubt that I'll ever see it released unless someone beats him and he's forced to release it as Freeware. Just sounds to me like he wants to have only one release, which is perfect, instead of doing what other authors do—release Release 1, then Release 2, 3 etc. Perhaps he should consider doing as others have and are doing, allowing you to exchange your old release for the new release.

Of course he could do this if he ever thought he would put any more time into the product. However, I believe that we will never see this one and that we will instead end up with 10 top quality flight simulators just like we ended up with 10+ graphics creation packages.

Does anyone know if Myarc ever made the 512K card compatible with the CorComp RS232 card for spooling purposes?

I just got the Myarc disk controller card and it is absolutely great. Their disk based Disk Manager is indeed supreme. I've tried a lot of disk based disk managers before and always ended up back using the Disk Manager II cartridge simply because of its ease of use. Now I do use the supreme Disk Manager.

The Call Directory command also is a godsend for those of us who just haven't totally catalogued all of our disks with a master list and labeled them properly.

Isn't it time that we skip an issue to catch up to the month that your maga-

zine should come out? Why continue to be sloppy with the issue date?

Your magazine is professionally done and to allow the issue date to indicate outdated prior information is a mistake which detracts from people's perception of your publication.

Do a double issue—even if you have to publish a lot of letters—give advertisers a one-time discount—staple the issue together because of printing constraints.

Joe Constance

Pittsburgh, Pennsylvania

Lou Phillips of Myarc says the Myarc 512K card will not work with the parallel port of the CorComp RS232 because of "architectural differences."

The changes in procedure and techniques required for a double issue would probably throw us off even further.—Ed.

## Memory expansion card query

There has recently been quite a lot of fanfare over memory expansion cards, even a number of reviews. I find that in all such reviews, however, little is ever said of the usable CPU memory; rather, all discussion turns toward RAMdisk and spooling functions. Is this all these cards can do?

Are Extended BASIC and Multiplan and TI-Writer able to take advantage of these cards, or are they limited to 32K of CPU memory?

With the advent of several "cartridge to disk" hardware/software systems, is it reasonable to assume that one could with very little programming modify a program which has been dumped to disk so that it could utilize a full 512K of CPU memory?

I would very much appreciate a discussion on these memory expansion cards from the standpoint of CPU memory expansion. In this discussion it would seem reasonable to include Geneve. Is it truly a 640K machine expandable to 1MEG, or is its capability based only on totally new software

without hopes of using existing TI software to take advantage of this memory?

Gerald L. Katrana  
Aurora, Colorado

RAMdisk memory has nothing to do with the Central Processing Unit (CPU). A RAMdisk is analogous to a floppy disk in that it is a repository for data (programs and files). As such, a user may write a file created by a program such as Multiplan to the RAMdisk. The principal advantage of a RAMdisk over a floppy is its much faster access time on input/output operations. Also, a battery backed RAMdisk is capable of retaining programs and files even when the computer is turned off.

Since the CPU of the TI is not expandable per se, the modifications you suggest for TI-Writer, etc. would not be possible, though if a larger CPU were available I am sure a number of talented programmers would be able to take advantage of it.—Ed.

## Easiest BBS?

In the August issue letters column there was a man who wanted to know of an easy BBS to hook up. Well, my BBS System is the easiest BBS to hook up. It uses standard TI modem cable with a one pin modification. Pin 8, the carrier detect lead, must be connected to pin 19 on the RS232. This tells the software that the person has hung up.

Nick Iacovelli Jr.  
Melrose Park, Illinois

*The Feedback column is for readers. It is a forum to communicate with other readers. The editor will condense excessively lengthy submissions where necessary. We ask that writers restrict themselves to one subject for the sake of simplicity. Our only requirement is that items be of interest to persons who use the TI99/4A home computer. Mail Feedback items to: MICROpendium, P.O. Box 1343, Round Rock, TX 78680.*

# TEX+COMP™

America's Number One TI computer retailer

## puts the big names in software on line.



### PAC-MAN CENTIPEDE DONKEY KONG\*



PAC-MAN, CENTIPEDE & DONKEY KONG ARE THE ALL TIME FAVORITE ARCADE GAMES. NOW YOU CAN ENJOY THE EXCITEMENT AND ACTION OF THESE BEST SELLERS RIGHT AT HOME WITH YOUR TI-99/4A. TEX-COMP HAS JUST PURCHASED THE REMAINING INVENTORY OF THESE THREE ARCADE GAME MODULES BY ATARISOFT AT A SPECIAL PRICE AND IS PASSING THE SAVINGS ON TO YOU. DON'T CONFUSE THESE TOP RATED VIDEO ARCADE GAMES WITH THE OTHER ATARISOFT GAMES FOR THE TI-99/4A. THESE ARE THE ABSOLUTE BEST AND THE HARDEST TO GET AS THEY WERE ONLY MADE IN LIMITED QUANTITIES.

It's the best software at the best prices **\$9<sup>95</sup>** each +s&h  
**BUY 2—GET 1 FREE!** **\$19<sup>95</sup>** all three +s&h

Send order and make checks payable to:

**TEX+COMP**

P.O. BOX 33084—GRANADA HILLS, CA 91344



AUTHORIZED DEALER



VISA and MASTERCARD  
 HOLDERS CALL DIRECT  
**(818) 366-6631**  
 24 Hour Order Line

**TERMS:** All prices F.O.B. Los Angeles. For fastest service use cashiers check or money order. Add 3% shipping and handling (\$3.00 Minimum). East of Mississippi 4 1/2%. Add 3% for Credit Card orders. Prices and availability subject to change without notice. We reserve the right to limit quantities.

**NOTE:** Payment in full must accompany all orders. Credit card, Company check or Money order for immediate shipment. Personal Checks require up to 4 weeks to clear. California orders add 6 1/2% sales tax.

Send \$2.00 for our new 99/4A 30-page catalog and buyer's guide.

© 1986 TEX-COMP

## Part II in a series on computer graphics

## Two-dimensional transformations

## You don't have to be a physicist

By DARREN LEONARD

First, two errors in my first article (June 1986) have been brought to my attention.

The corrections are:

Subprogram circle on page 20 should include the line

```
155 CALL PUTDOT(X,Y)
```

Subprogram putdot's line 507 should have read

```
507 IF A<>32 THEN C=C+1 ELSE
A=C:: IF C<34 THEN 531
```

Now that we have taken care of the past it is time to move on. As promised, I will begin two-dimensional transformations in this article, but I would like to cover another useful application of the PUTDOT subroutine.

If you have had any physics or post-algebra mathematics, you are probably aware that there is an equation to describe just about anything. An equation describes the motion of the earth around the sun. An equation (albeit a long one) was used to plot the motion of the astronauts on their way to the moon. An equation can be used to determine the path (trajectory) of a bullet (projectile).

You don't have to be a theoretical physicist to appreciate the usefulness of such equations, nor need you be more than five years old to realize that the digital computer is the ideal tool to utilize these equations.

Don't let what I am about to do intimidate you. You needn't know any physics to learn something here. All you need is the will to learn.

Let's take a closer look at the bullet being fired out of a gun. Assume there is no air resistance and that no other forces influence the projectile except gravity. The weight and shape of the projectile are immaterial.

Let's say we know three things about

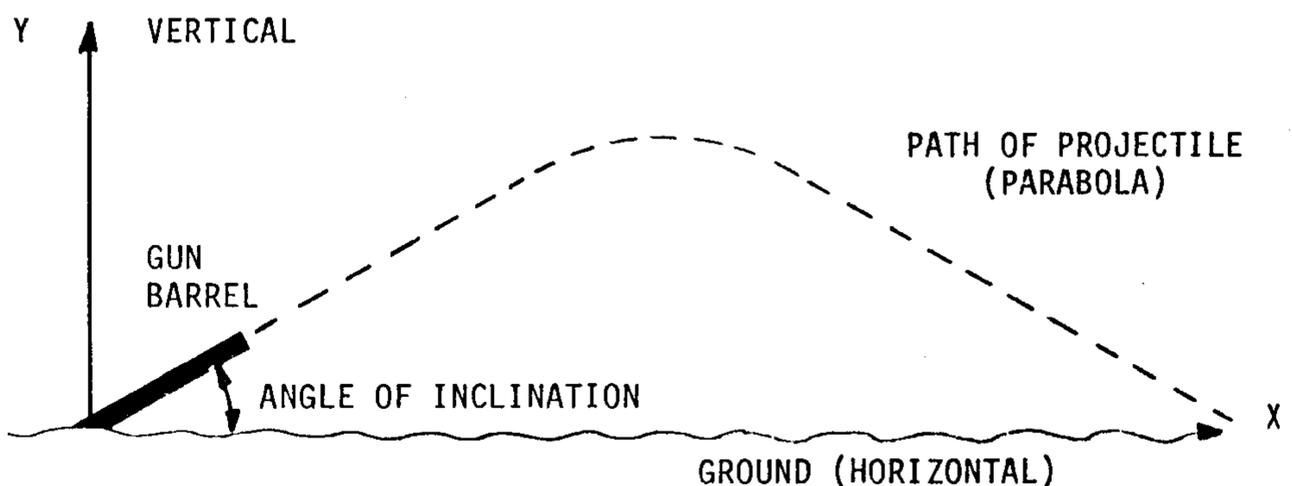

Fig. 1 SKETCH OF BALLISTIC PROBLEM

the situation of the muzzle of the gun:

1) The velocity of the bullet as it exits the barrel. Since there is no air resistance (i.e. hypothetical situation), the velocity will remain constant for the entire time. Units bear no direct consequence in this example so you may use miles per hour, meters per second, or, if you wish, furlongs per fortnight.

However, if you are interested in comparisons of the flight path of two projectiles that differ only in angle of inclination from the horizontal or in velocity, you should be consistent. We will use the variable  $V$  to indicate velocity.

2) The angle of inclination from the  
(Please turn to Page 14)

```
100 REM PATH OF PROJECTILE
110 REM DARREN LEONARD 11/83
120 REM PUTDOT SUBROUTINE MUST BE APPENDED
130 REM IN ORDER FOR THIS TO WORK
140 REM
150 PRINT "ENTER THE VELOCITY OF BULLET"
160 INPUT V
170 PRINT "ENTER ANGLE OF INCLINATION OF THE"
180 PRINT "MUZZLE FROM THE HORIZONTAL IN"
190 PRINT "DEGREES"
200 INPUT Z
210 Z=Z*(PI/180)!CONVERT DEGREES TO RADIANS
220 PRINT "ENTER TIME INCREMENT IN SECONDS"
230 INPUT DT :: CALL CLEAR
240 T=0
250 X=INT(V*COS(Z)*T-100)!DETERMINE HORIZONTAL DISTANCE
260 Y=INT(V*SIN(Z)*T-(1/2)*32.2*T*T)-45 !DETERMINE VERTICAL DISTANCE
270 IF Y=0 AND T=0 THEN 150 !STOP WHEN BULLET HITS GROUND
280 CALL PUTDOT(X,Y)!PLOT POSITION AT THIS INSTANT
290 T=T+DT :: GOTO 250
300 END
```

**CHARAMAT** is a graphics development tool for Extended Basic programmers. It consists of an editor and 16 support routines all written in assembly language. The editor performs the following four functions at the same time:

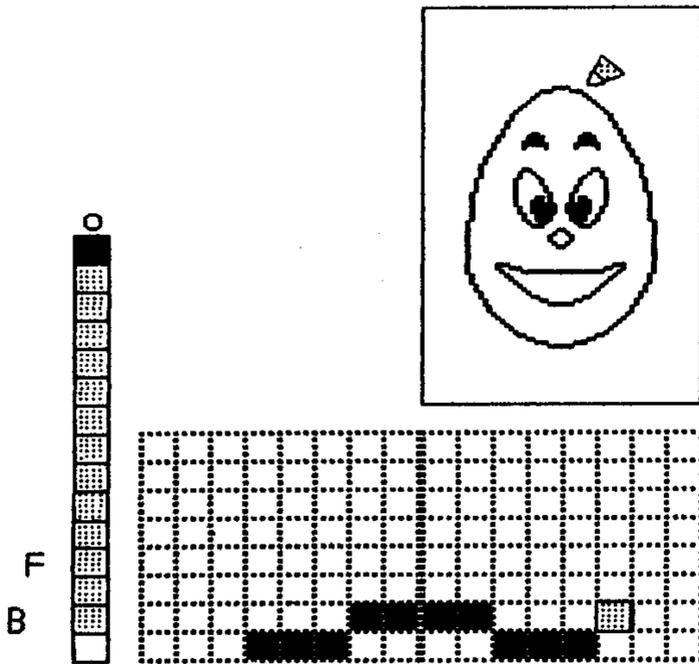

- \* Allows you to draw smoothly within a rectangular window, in which 8 times 14 characters of Extended Basic are shown without spaces in between. In other words, you draw an instance of size 64 times 112 pixels.
- \* Displays the current character being drawn, magnified by a factor of 8. The left adjacent character is also displayed.
- \* Shows the ASCII code of the current character.
- \* Shows the colors of the current character. Colors can also be changed with the editor.

The editor has many additional features. It can, for instance, be used in debugging an Extended Basic program. - The 16 support routines allow use of the computer's memory for the storage of graphics data and perform data transfer to disk with assembly language speed. They open a new dimension to programmers interested in print graphics or screen animation. - The editor is easy to use and makes short work out of creating Extended Basic graphics.

**\$39.90** Requires 99/4A, TI Extended Basic, 32K, disk.

**PRINT DESIGNER** allows full use of the graphics capabilities of the Micronics S6-10 and NX-10 printers. It prints in three modes (compare the flower designs):

- (1) single density
- (2) double density horizontally and vertically
- (3) quadruple density horizontally and double density vertically

Pictures are first drawn for print modes (1) and (2). Next a special routine can be used to double every pixel horizontally and make the picture ready for print in mode (3). The design can then be refined anywhere you want. A picture may have up to 1920 pixels horizontally and is limited vertically only by what fits on a disk. Use with GRAPHX, TI-Artist or our own graphics design program, BIGCHAR, which is included. Produce fancy letterheads and labels, fill the Christmas and New Year days creating a full page picture, or just print your GRAPHX or TI-Artist screens in double density format.

**\$29.90** Requires 99/4A, TI Extended Basic, 32K, disk, S6-10 or NX-10.  
Two disk drives are required for use with GRAPHX or TI-Artist.

This ad was all made with PRINT DESIGNER and an NX-10 (using Basic for the text).

**Desaca  
Soft**

BOX 828, MENDOCINO, CA 95460

California orders add 6% sales tax.

All trademarks are assigned to respective owners.

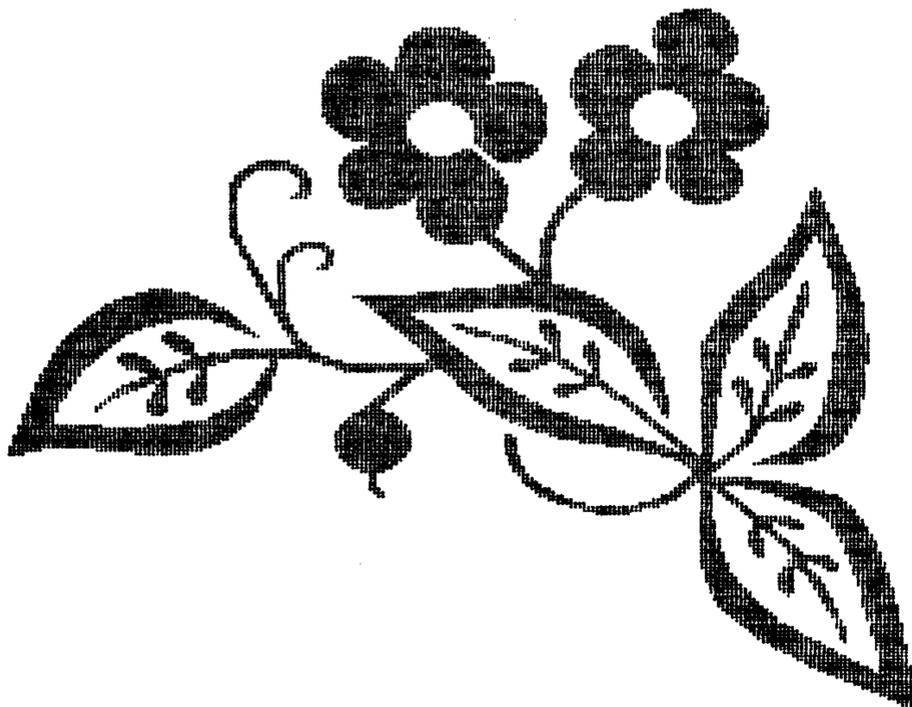

## TWO-DIMENSIONAL TRANSFORMATIONS—

(Continued from Page 12)

horizontal of the muzzle. We will refer to this angle as Z. (See Fig. 1.)

3) That the path of a projectile as a function of time, velocity and initial angle can be determined by the equations:

$X = V \cdot \cos(Z) \cdot T$  where T is time and X is horizontal distance.

$X = V \cdot \sin(Z) \cdot T - (1/2) \cdot 32.2 \cdot T^2$  where Y is vertical distance, T is time and 32.2 is the gravitational constant. (Before you engineers and physicists out there begin forming a lynch mob, I realize that I have made a lot of assumptions and have idealized the situation quite a bit, but I feel that it will illustrate the usefulness of computer graphics for other than video games.)

We are now prepared to write our program. (If you are clueless, just enter the program, run it and forget Newton.)

I would like to point out a few things that may help here.

The greater the velocity, the straighter the path. The smaller the time increments, the smoother the path. Because of the limited resolution of the 99/4A, you will have to test different values of time increments to come up with the smoothest curve possible.

If you get an error, try different values at the input. The angle should be between 0 and 90 degrees. Try different values and prove to yourself that a bullet will travel the greatest distance if it is shot at 45 degrees from horizontal.

I will leave it as a thought exercise for you to determine the initial conditions. Stop and think for a few minutes and impress yourself with what you know about the world around you. Incidentally, don't hesitate to use time increments of .1 or .01 seconds; any positive time increment is legal. Don't use negative increments unless you have discovered a method of reversing time. (If you have, you are wasting your time reading this.) Enough said.

(Try these starting values: Velocity = 75; Angle in degrees = 45; Time increment = .10—Ed.)

### 2-DIMENSIONAL TRANSFORMATIONS

One of the great misfortunes of mathematics is that in order to do something on the top of the pyramid, you must learn what is on the bottom first, and CAD is no different.

Now I will introduce you to some simple matrix (array) transformations. It is the matrix that allows us to rotate a square (or cube) and I will show the method of doing this once the array is covered.

After this introduction to the array, you should have a good understanding of what an array is and what you can do with it. Though it may seem a drag right now, it may benefit you in future programming. It is not absolutely necessary that you fully comprehend all this in detail to utilize the program, but if you have some idea of what is going on, you are apt to get more out of this article.

From experience, I have found that mathematicians use the term "matrix" and computer enthusiasts use "array." Since they are pretty much the same, I will use the terms interchangeably.

A variable is a character that is used to represent a value.

For example,  $A = 69$  means that A has the same value as 69 so if you have a line in your program that looks like this:

```
130 LET A = 69
```

you may use either A or 69 in your program to work with the value of 69. This being the case:

```
A + 1 = 70 and 69 + 1 = 70
```

The ability to use this type of variable this type of variable is useful to a point, but if you are working with lots of numbers, you will soon realize that it is severely limited. Therefore, we bring into play the subscripted variable.

If you have been working with TI BASIC, you are aware that you can use numbers in your variable names. Thus, A1, A2, A3, B9 and C8I are all legal variables. This is fine for simple ap-

plications, but suppose you wanted to be able to access the values of A1, A2 etc. in quick succession so you could sort them. If we introduce subscripting, we have efficiently solved our problem.

Let's say that

A(1) = A1

A(2) = A2

A(3) = A3...

If you look in your manual, you will notice that it is allowable to use a variable within the parentheses to indicate which element of the subscripted variable we want. Therefore A(J), if J=2, will have the same value as A(2) or A2. Since J is a variable, it can be incremented, looped, decremented and manipulated to suit your need.

With J (or any other variable used for this purpose) being operated on by the program, the computer is easily able to process sizable amounts of data. A() is called many different things, but the terms you are most likely to hear include one-dimensional array, vector array and possibly linear array.

Now suppose that we have the numbers in the array A() written on page one of a book. Also suppose that we have several numbers written on page two of that same book. Let's say we want to sort the numbers on each page but we wish to keep the two pages separate.

One way of doing this would be to have two vector arrays and operate on each one individually.

A( ) contains the information on page one of the book.

B( ) contains the information on page two of the book.

This would work for this situation, but would be cumbersome in more cumbersome applications. If we remember that A() is 1 and B() is 2 we can set up a two-dimensional array to include both pages of data. Say there are 20 numbers on each page to be sorted. If we set up an array of size C(2,20) and use the variables K and J to subscript the array such that it is ac-

(Please turn to Page 16)



# RAPID COPY

If your tired of waiting for your disk manager to copy or format your disks, Rapid Copy is here to help you. Rapid Copy is the only turbo copier specifically designed to take full advantage of the Myarc, CorComp, and Texas Instruments disk controller cards.

How fast is Rapid Copy? Copying a double-sided, double-density disk takes only 1 minute and 17 seconds, which includes formatting the target disk! On average Rapid Copy is six times faster than the disk copy functions of the Myarc, CorComp, and DM1000 disk managers.

Rapid Copy is simple to use, fully menu driven, and allows a multitude of copy and format options. Not only is Rapid Copy endorsed by Myarc Inc. for use with its disk controller card, a new modified version of the Myarc disk manager (included) allows you to load it from within its utility option for your convenience!

Rapid Copy is available for only \$14.95. Requires 82K memory expansion, disk drive system consisting of at least one floppy disk drive, and either the Extended Basic, Editor/Assembler, or TI-Writer command module.

**CALL US FOR THE BEST DEAL ON ALL MYARC PERIPHERAL PRODUCTS!  
WE GUARANTEE TO BEAT ALL COMPETITOR PRICING (proof required).  
MYARC 128K, 256K, 512K MEMORY CARD UPGRADES PERFORMED ON SITE!**







#1 Graphics Program

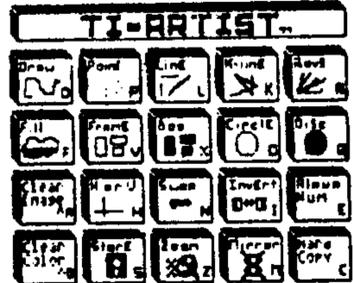

All New Version 2.0

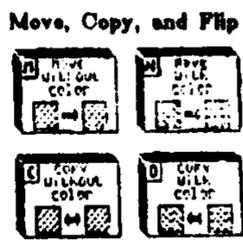

Move, Copy, and Flip







Powerful font, slide, and instance entry features.

Only \$19.95

The extremely user friendly menu system (illustrated above) allows many powerful integrated functions. Provides excellent user adjusted screen dumps using Epson (compatible), Okidata 92 and 93, Axiom GP-100 and Prowriter printers. Disk drive, memory expansion, and either XB, E/A, or MM required.

**Artist's Companion #1**

A huge set of five disks that contain a complete set of graphics designs to be used with TI Artist. The package includes 25 character fonts, 160 small original pictures and 30 large original pictures. A must for TI Artist!

Complete Five Disk Set \$17.95

**Display Master**

An all new program which allows users to create TI Artist screen/slide presentations! 100% user defined and directed presentations can be made easy using Display Master's command language and any text editor (TI Writer, E/A etc)

Display Master Package \$14.95

**Artist's Companion #2**

An all new set of graphic designs to be used with TI Artist. This package includes 13 character fonts and 60 small original pictures. Also included is Artist's Connection which allows you to use TI Artist instances in BASIC!

Complete Two Disk Set \$9.95

## Texaments

53 Center Street, Patchogue, New York 11772

Please add shipping charges as follows: \$2.00 for software, \$4.00 for hardware. Call our office (516-475-8480) or bulletin board service (516-475-6468) for additional information. All C.O.D. orders must be called in. Sorry no credit card orders accepted. Prices and availability subject to change without notice. Dealer inquiries are invited.

## TWO-DIMENSIONAL TRANSFORMATIONS—

(Continued from Page 14)

cessed as C(K,J) when L and K have values, K indicates which page and J indicates which element.

This being the case

$$C(1,3) = A(3) = A_3$$

$$C(2,5) = B(5) = B_5$$

$C(I,J) = A(J)$  regardless of the value of J

$C(2,J) = B(J)$  regardless of the value of J

Just for the sake of it, let us say that we have a second book with two pages of information on it. In book 2 the information could be stored for the first page in array D() and the second page in array E(), or both could be stored in a similar method as above in the 2-D array F( , ). This would give us two separate 2-D arrays to handle to work with our data.

Array C( , ) has the information in book one.

Array F( , ) has the information in book two.

This is workable, but it is not very convenient if you are switching books a lot. Here comes the three-dimensional array. (We are not going beyond 3-D.) We will use the matrix G(2,2,20) to store our data. We will use the subscripted notation of G(L,K,J) to identify which book, page and element we want to read. Thus, L is book number, K is page number and J is still element number. With this in mind, let's examine a few samples:

$$G(1,1,1) = A(1) = A_1 = C(1,1)$$

$$G(1,2,4) = B(4) = C(2,4)$$

$$G(2,2,8) = E(8) = F(2,8)$$

$$G(2,1,7) = D(7) = F(1,7)$$

Simple, right?

Here is where the real fun starts. Suppose we have to multiply one matrix with another matrix. There is a specific order in which this occurs. Listed below is the subprogram that will multiply a matrix A(N,N) and B(N,N) and produces matrix C(N,N).

Comments about this subroutine:

The arrays A, B and C must be dimensioned in the main program.

The numerical values of the elements of A and B must be entered in the main program. Thus, when you gosub to the subroutine you will have two full arrays and one empty one. the resulting

Fig. 2 Matrix A

3	5	1	9
1	7	2	8
4	1	3	9
4	0	7	7

Matrix B

2	1	7	3
1	5	1	0
6	5	5	1
8	0	6	3

matrix will be in C.

I strongly recommend that you get a piece of paper and follow, step by step, what the subroutine is doing.

In order to preserve your sanity, we have provided examples. See Figs. 2 and 3.

Now, you must multiply the first row of A by the first column of B to determine the first element of C

$$A(1,1)*B(1,1) + A(1,2)*B(2,1) + A(1,3)*B(3,1) + A(1,4)*B(4,1) = C(1,1)$$

thus

$$3*2 + 5*1 + 1*6 + 9*8 = C(1,1)$$

$6 + 5 + 6 + 72 = 89$  and this means that  $C(1,1) = 89$

$C(1,2)$  is obtained by multiplying the first row of A by the second column of B.

$C(3,4)$  is determined by multiplying the third row of A by the fourth column of B, and so on.

The first subscript is the row of A and the second subscript is the column of B. Got it? If not, look at the chapter on matrices in any algebra or calculus book.

If A is multiplied by B, then the matrix C should look like this. (Check it with your results to see whether you are following this.)

Fig. 3 Matrix C

89	33	85	37
85	46	72	29
99	24	98	42
106	39	105	40

Now that we have a feel for matrices and multiplication of them, we are ready to proceed into the applications to graphics.

In order to do complicated graphic transformations, we must enter our datapoints (screen coordinates of what is to be plotted) into a matrix form.

(Please turn to Page 18)

```

100 REM MULTIMATRIX (TO BE USED AS A SUBROUTINE)
110 REM DARREN LEONARD 9/86
120 REM ARRAY C(N,N) MUST BE DIMENSIONED IN MAIN PROGRAM
130 FOR I=1 TO 4
140 FOR J=1 TO 4
150 SUM=0 !TEMPORARY VARIABLE
160 FOR K=1 TO 4
170 SUM=SUM+A(I,K)*B(K,J)! MULTIPLY EACH ROW OF A BY EACH
180 NEXT K !COLUMN OF B TO DETERMINE C
190 C(I,J)=SUM
200 NEXT J
210 NEXT I
220 RETURN !MUST BE CALLED FROM A GOSUB COMMAND

```

THE CHICAGO TI USERS GROUP PROUDLY PRESENTS

# TI FAIRE

# 1986

## FOURTH ANNUAL TI FAIRE

**When:** Saturday, November 1, 1986—from 9:00 AM to 6:00 PM  
**Where:** The Ironwood Room of the Student Center Building at Triton College, 2200 N. Fifth Ave., River Grove IL. (1/4 mile north of North Ave., near the Maywood Park race track).

**Who:**

Clint Pulley	<b>Demonstrations by:</b>
Chris Bobbitt	“C”
Lou Phillips	Asgard Software
	Myarc Hardware
	<b>Presentations by:</b>
Al Stump	Care and maintenance of your TI99/4A computer.
Pete Hoddie	Making music on the TI.

**Over 20 VENDORS including:**

Asgard Software	BBS Computer Sales
Boston Computer Society	Bud Mills Services
C and G Drives	Competition Computer
CompuServe	Databionics
DataBioTics	Databiotics
Great Lakes Software	Genial TRAVeLER
Horizon Computer Ltd.	Hunter Electronics
JD Limited	LL Conner Ent.
Megatronics	Micro Format
Myarc	Ottawa Users Group
PC Pursuit	Tenex
TIgercub Software	Trio Software
Ryte Data	Softmail

**ADMISSION \$2.00**

**For further information:** Call Grant Schmalgemeir at 312-477-0690 between 10:00 PM and 11:30 PM Central Time

*Make it a TI weekend. The Milwaukee Area TI Users Group is sponsoring their first TI Faire on Sunday, November 2, 1986. The Faire will be held at the Milwaukee Area Technical College (MATC), South Campus at 6665 S. Howell (Hwy. 38) Oak Creek, WI. (just south of General Mitchell Field).*

## TWO-DIMENSIONAL TRANSFORMATIONS—

(Continued from Page 16)

Once we have our data in a matrix, we will multiply it by another matrix to determine the new screen coordinates for the altered shape. The matrix that we multiply our data array by will depend on whether we want to rotate, scale or transform it.

Very simply, rotating is changing the orientation of the shape about a certain point, scaling is changing the size of the shape and translating is moving the shape to a different screen location.

Let's use a simple array A(2) such that A(1)=X and A(2)=Y, i.e., the original coordinates are in matrix A and will be altered. The altered coordinates will be designated with a prime. In other words, X' is the new X coordinate and Y' is the new Y coordinate.

With this in mind, let's proceed to scaling.

### SCALING

The size of an image can be increased or decreased by means of a scaling

transformation,  
 $X' = S * X$  and  $Y' = S * Y$

Graphically, scaling is shown in Fig. 4.

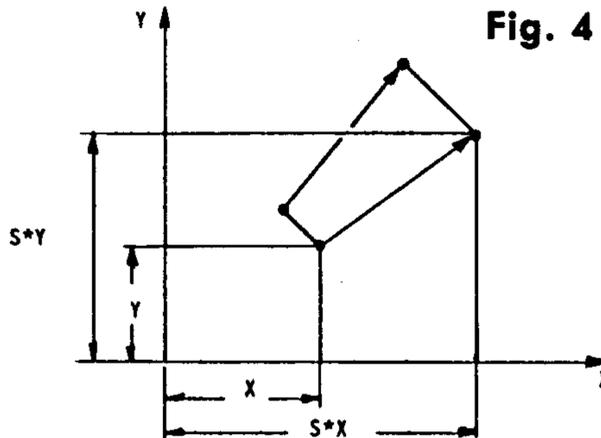

This transformation is represented in matrix form as

$$\begin{pmatrix} X' \\ Y' \end{pmatrix} = \begin{bmatrix} S & 0 \\ 0 & S \end{bmatrix} \times \begin{pmatrix} X \\ Y \end{pmatrix}$$

If this transformation is applied to each point defining an image, the en-

tire image will be scaled (up or down). The effect of this scaling transformation is dependent on the numerical value of S. If S is unity (one) then there will be no change in the size. If S is less than one, the size will decrease and if S is larger than one, the size will increase.

The further S is from 1, the more profound the change in size will be. For example, a scale factor S of .3 will produce a smaller shape than a scale factor of .6

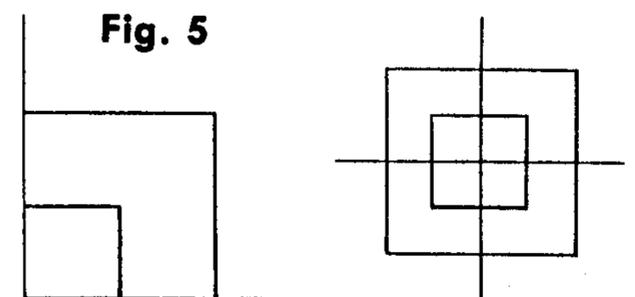

The effects of scaling depend on the location of the image with respect to the coordinate system. (See Fig. 5.) In  
 (Please turn to Page 20)

## The Printer's Apprentice

Omaha -- McCann Software introduced The Printer's Apprentice for the TI-99/4A and dot matrix printers. The software assists users with all aspects of custom page creation: font design, text formatting, artwork editing and page layout. Unique text handling features include microjustification of proportionally spaced custom fonts and hyphenation.

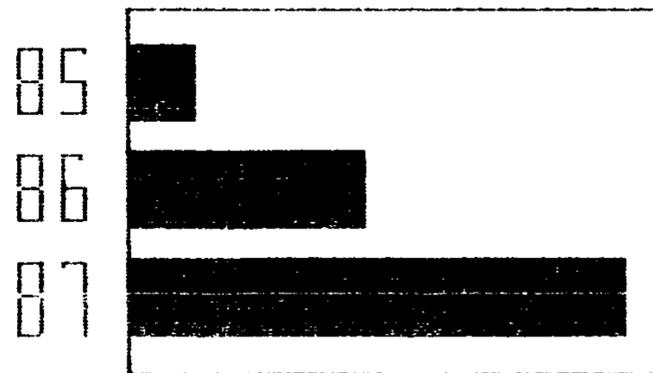

Rise of Desktop Publishing

The text formatter accepts TI-Writer files and the artwork editor accepts ".P" files from artist programs. The Printer's Apprentice requires 32K memory, disk system and takes full advantage of the high density of 99/4--Epson and Gemini type graphics printers.

The Printer's Apprentice is priced at \$22.50. In addition, the company's Business Graphs 99 is now \$15.95. To order send check or money order to:

**McCann Software, P.O. Box 34160, Omaha, Nebraska 68134**

This ad produced using The Printer's Apprentice, Copyright 1986 Mike McCann. All rights reserved.

# UNBELIEVABLE PRICES ON 2 IMPORTANT PERIPHERALS

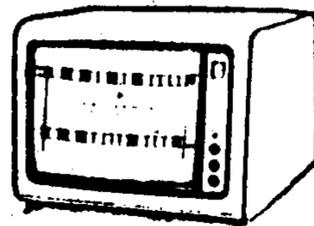
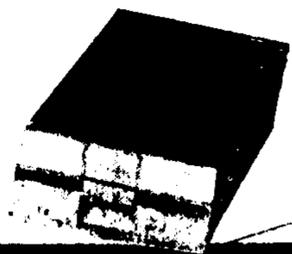

**ADD A 2ND DISK DRIVE TO YOUR TI/99/4A SYSTEM FOR ONLY**

Comes complete with drive, case, power supply & cable. Ready to connect.

By adding a second drive to your system you can free yourself from swapping program and data disks on many programs. You can also make backups without any disk swapping.

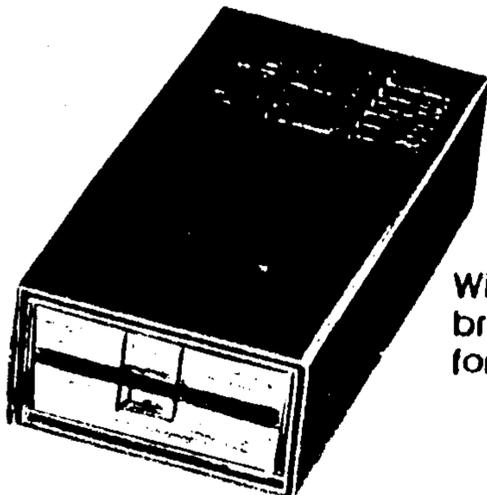

**\$129<sup>95</sup>** Plus S&H

**ADD \$20.00 for DS/DD Drive.**

**EXTRA VALUE BONUS**

With each disk drive ordered we are including a HEAD brand disk drive head cleaning kit which regularly sells for \$15.95.

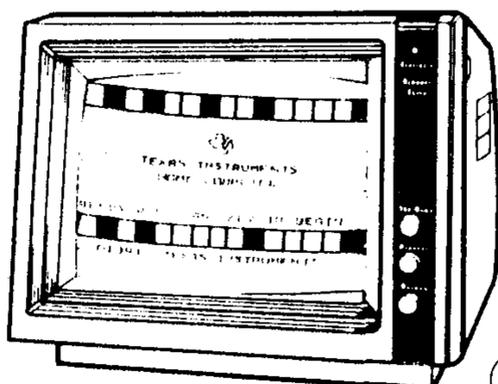
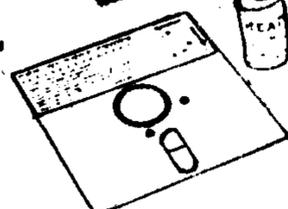

MONITOR CABLE INCLUDED !!

**color monitor**

Composite Video for use with computers, tuners, VCRs and video discs.

**\$129<sup>95</sup>**

TEX-COMP has purchased a truck load of 13" COLOR MONITORS at a special price. These monitors are built by two of the leading names in consumer electronics, Samsung and Goldstar and come with a 90 day factory warranty on parts and labor. A TI-99/4A monitor cable is included at no extra charge. There is no comparison between a monitor and a TV set when it comes to computing. The monitor picture is sharper, clearer and more vivid. Works great with your VCR too. 330 X 330 Resolution Add \$10.00 for shipping and insurance

**Special**  
FACTORY  
**Purchase**

Send order and make checks payable to:

**TEX+COMP**

P.O. BOX 33064 - GRANADA HILLS, CA 91344



AUTHORIZED DEALER



VISA and MASTERCARD  
HOLDERS CALL DIRECT  
**(818) 366-6631**  
24 Hour Order Line

**TERMS:** All prices F.O.B. Los Angeles. For fastest service use cashiers check or money order. Add 3% shipping and handling (\$3.00 Minimum). East of Mississippi 4 1/2%. Add 3% for Credit Card orders. Prices and availability subject to change without notice. We reserve the right to limit quantities.

**NOTE:** Payment in full must accompany all orders. Credit card, Company check or Money order for immediate shipment. Personal Checks require up to 4 weeks to clear. California orders add 6 1/2% sales tax.

Send \$2.00 for our new 99/4A 30-page catalog and buyer's guide.

©1986 TEX-COMP

**SST Expanded Basic Compiler**  
\$25.00

**With Graphics and Text Mode**  
\$35.00

**NEW VERSION**

The new compiler system now compiles and loads programs almost 3 times faster (some have been compiled up to 5 times faster).

**REVIEW** - The Compiler received an excellent rating for performance and documentation in a review in the HOME COMPUTER MAGAZINE, Sept., 1984.

The Compiler translates Basic programs into TMS 9900 machine language. It contains most of the features of Extended Basic plus many others. Requires memory expansion, disk, E/A or MM module.

**PRE/SST PROGRAM - \$30.00**

Facilitates preparing existing programs for processing by the SST Compiler. Makes developing new programs easier. Requires extended Basic and memory expansion.

Send check or money order or write for information to:  
SST Software, Inc., Box 26,  
Cedarburg, WI 53012

**—A SPECTRUM OF SOFTWARE—  
NEW SOFTWARE FOR THE  
TI-99/4A—ON COLORED DISKS**

**\*\*\* ASSEMBLY LANGUAGE GAMES \*\*\***

**BUBBLE PLANE** \$15.00  
You pilot the Bubble Plane. Your mission is to shoot down enemy planes and destroy their base without getting yourself destroyed.

**BLUE BERT** \$15.00  
You control a magical blueberry, named Blue Bert, while you try to save your fruity friends, but beware of the evil Yuk, Spoiler, and Jailer.

**THE GREAT WHITE NORTH ADVENTURE** \$12.00  
The most exciting adventure ever! Find some priceless items i.e. The Golden Beerbottle and save the world from evil beer brewers. An expert adventure.  
\*Requires Adventure Command Module\*

**TI-NET BBS** \$30.00  
The TI-NET BBS. The fastest and best BBS available for the 4A. Up to 1000 users, up to 99 message bases, and excellent sysop functions. 2400 bps. optional.  
**FANTASY BOARD.** Similar to, but FASTER than, the Apple Proving Grounds BBS. Fight monsters or other users.  
TI-NET BBS required **ONLY \$15**  
**REQUIRES HAYES COMPATIBLE MODEM**

The action games require X-Basic, and Memory Expansion. All programs on Disk Only. When ordering BBS, please specify drive configuration

Send Check or Money Order  
or for more information  
write to:

**GADEGO SOFTWARE**  
3402 93rd  
Lubbock, TX 79423

Call the TI-NET Headquarters for more info—201-972-9322!!

## TWO-DIMENSIONAL TRANSFORMATIONS—

(Continued from Page 18)  
the form on the left the coordinate system origin is at the lower left corner and the scaling enlarges the image and also translates its center.

In the figure on the right, the coordinate system origin is also the geometric center of the image. The image is simply expanded because the positive coordinates and negative coordinates become more negative. Thus, rescaling of images after they have been displayed should be done with reference to their geometric centers to avoid unwanted translations.

If you are the type who likes to figure things out himself, you should now be able to scale an object. If you are not sure, read on about translation and we will give you some examples to help clarify things.

### TRANSLATION

One of the simpler transformations available in computer graphics is translation, or movement of the image to another location on the screen. During translation, no rotation or change in size occurs. Any point (X,Y) at the end of a line segment can be moved to another location (X',Y') by translating it through a distance XT in the X-direction and YT in the Y-direction. That is  $X' = X + XT$  and  $Y' = Y + YT$

If the same translation is applied to the point at the other end of the line segment, then the entire segment will be translated the same distance without a change in size or orientation as in Fig. 6.

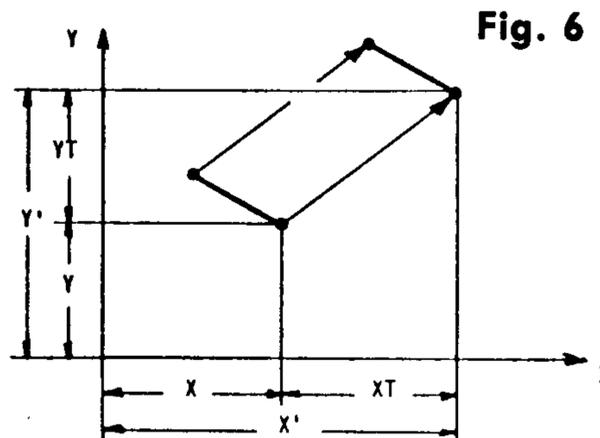

Fig. 6

The translation equations above can be represented in matrix form if we consider that the original coordinates

(X,Y) as a 2x1 matrix (column vector) operated on by a 2x3 transformation matrix to give the transformed coordinates (X', Y') as a column vector.

This just means:

$$\begin{pmatrix} X' \\ Y' \end{pmatrix} = \begin{bmatrix} 1 & 0 & XT \\ 0 & 1 & YT \end{bmatrix} \times \begin{pmatrix} X \\ Y \\ 1 \end{pmatrix}$$

Remember what we learned about multiplying matrices and see that  $X' = 1*X + 0*Y + 1*XT$  which is equal to  $X + XT$

$Y' = 0*X + 1*Y + 1*YT$  which is equal to  $Y + T$

If you are wondering why it is necessary to use matrices to do this when all you need to do is add XT or YT to each point just before you plot it, consider what happens when you have several hundred points to plot. You would have to write pages of a program to accomplish what a matrix with loops can do.

At this point you know now all you need to know to plot an image and translate and scale it. However, all these bits and pieces of knowledge are nearly useless unless they can be integrated into one coherent program.

If you have time, I urge you to try to piece together all the material from these two articles and plot a square and scale it and move it about the screen.

The best way to learn something is to figure it out yourself once you have been provided with the preliminaries. I will provide you with a program that will incorporate everything to date in the next article. I will also go into rotating shapes in 2D in the same article.

A few closing words that might help.

The TI99/4A has very limited resolution. Keep this in mind when your image looks distorted. This is an intrinsic limitation of the machine and little can be done about it.

If errors or problems are occurring, make sure you are not trying to plot outside the screen. In general, it is best to work with a shape that is about 1/3

(Please turn to Page 22)

**9900 + FOR THE TI99/4A  
THE ULTIMATE  
99/4A EXPANSION SYSTEM  
AT A SPECIAL  
INTRODUCTORY PRICE  
FROM TEX-COMP™**

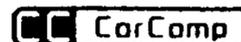
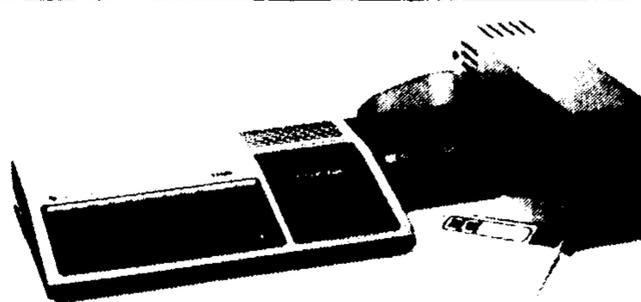

TEX-COMP, the undisputed leader in supplying the 99/4A User, has now put together the finest and most complete expansion system ever offered for the TI99/4A.

**COMPLETE  
EXPANSION SYSTEM  
NOTHING ELSE TO BUY!**

- **9900 Expansion Box & Regulated Power Supply (UL Approved)**
- **32K Memory Upgrade** Adds 32K bytes of Random Access Memory to your system.
- **Double Sided/Double Density Disk Controller** (operates up to 4 drives)
- **RS232 Interface** Lets you add a wide range of other accessories, such as printers or telephone modems, one parallel and 2 serial outputs.
- **1 SS/SD Disk Drive** Allows you to store and retrieve data on 5 1/4-inch single-or double-sided floppy diskettes.
- **1 Disk Drive Case & Regulated Power Supply**  
Handles two 1/2-height drives easily (UL or LAC Approved)
- **New Disk Manager with Improved Disk Utilities**
- **All Cables & Instructions** Including a free TI RS232 Y-Cable.

**ALL FOR  
\$379.95**  
Plus S&H

**For above system with full size DS/DD Disk Drive** \$399.95  
**For above system with a pair of 1/2-height Drives** 539.95

Other leading CorComp Hardware Values:

CorComp RS232 Card (for TI P-Box)		79.95
CorComp 32K Card (for TI P-Box)		99.95
CorComp DS/DD Controller (for TI P-Box)	<b>NEW LOW PRICE</b>	<b>149.95</b>
CorComp 9900 System with Free RS232 Y-Cable	<b>NEW LOW PRICE</b>	<b>299.95</b>
CorComp Stand Alone RS232 with Free Y-Cable		109.95
<b>NEW</b> CorComp Stand Alone 32K	<b>NEW LOW PRICE</b>	<b>89.95</b>
<b>NEW</b> Triple Tech P-Box Card (Clock/Buffer)		109.95
<b>NEW</b> 9900 Clock Stand Alone		69.95
"Grom Buster" (for 1983 Consoles)		24.95
Load Interrupt Switch (with <b>FREE</b> Screen Dump Program)		19.95
<b>NEW</b> PDI Diagnostic Module		24.95

**Also available from TEX-COMP at NEW LOWER PRICES:**

TI-99/4A Console w/1-year warranty (Black & Silver model)	79.95
<b>NEW</b> Star NX-10 (Fully TI Compatible). Replaces SG-10 solid state dipswitch selection—Free Cleaning Kit	259.95
1/2-Height DS/DD Disk Drive (2 will fit in P-Box)	99.95
Full Size SS/SD Disk Drive (exact replacement for TI 1250)	79.95
Full Size DS/DD Disk Drive	99.95
Drive Enclosure with Regulated Power Supply for 2 1/2-height or 1 full Drive	59.95
Cable Kit for 2 1/2-height Drives (for installation in P-Box)	29.95
Cable Kit for Stand-Alone Drives (specify TI or CorComp system)	29.95
RS2323 Y-Cable	10.95

**SEND \$2.00 FOR NEW 1986 CATALOG WHICH INCLUDES A \$5.00 SAVINGS CERTIFICATE.**



VISA and MASTERCARD  
HOLDERS CALL DIRECT  
(818) 366-6631

SEND ORDER AND MAKE CHECKS PAYABLE TO

**TEX-COMP™**

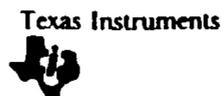

P O BOX 33084 — GRANADA HILLS CA 91344 AUTHORIZED DEALER

add 3% for credit card orders

**TERMS:** All prices F.O.B. Los Angeles. For fastest service use cashiers check or money order. Add 3% shipping and handling (\$3.00 minimum) East of Mississippi 4 1/2%. (Free shipping on all software orders over \$100.00). Prices and availability subject to change without notice. We reserve the right to limit quantities.

**NOTE:** Payment in full must accompany all orders. Credit Card, Company Check or Money Order for immediate shipment. Personal checks require up to 4 weeks to clear. California orders add 8 1/2% sales tax.

"The Leader of the Pack"

# Automatic Sprite Control

## 'Attach' a sprite to a joystick

By J. PETER HODDIE

One of the most powerful capabilities of the 4A is the ability to set a sprite in motion and have it continue its motion while the program continues to execute other code. This relieves the program of the time-consuming task of moving the sprite itself. This is one of the many "set it and forget it" features that TI built into the 4A.

The routines presented in this article carry that idea one step further by allowing a sprite to be more or less "attached" to a joystick so that the sprite is under joystick control while the program is executing other code. This means that the program doesn't need to have any code to control the motion of the user's sprite. You assign control of sprite No. 1 to joystick No. 1, and sprite No. 2 to joystick No. 2. You control the speed of the sprite, and how often the joystick is checked (up to 60 times a second!). There are also routines that tell whether the fire button has been pressed.

All of this is accomplished through the use of the user-defined interrupt routine pointed to by address 83C4. Fast scanning of the joystick is handled by checking the CRU bits directly, as documented in Miller Graphics' excellent Explorer manual. Handling the joystick scanning this way means that these routines won't work on a 99/4 or Geneve. It also means that the Q and Y keys will not be interpreted as fire but-

(Please turn to Page 24)

### TRANSFORM—

(Continued from Page 20)

the number of pixels available in a direction, i.e., an ideal square would measure about 70x70 pixels across.

Pay attention to what you are using for the coordinate origin!

If you are hopelessly lost, stay tuned for the next article, which should put you in the driver's seat.

```

DEF JOYSET
DEF FIRED1,FIRED2

NUMASG EQU >2008      ASSIGN FLOATING POINT NUMBER TO VARIABLE
NUMREF EQU >200C      GET FLOATING POINT NUMBER FROM VARIABLE
XMLLNK EQU >2018      LINK TO ROM ROUTINE
CFI EQU >12B8         CONVERT FLOATER TO INTEGER DATA FOR XMLLNK
FAC EQU >834A         ADDRESS OF THE FLOATING POINT ACCUMULATOR
GPLWS EQU >83E0       GPL WORKSPACE ADDRESS

VDPWA EQU >8C02       SET VDP WRITE ADDRESS
VDPWD EQU >8C00       VDP WRITE DATA ADDRESS

RADIX1 DATA >4001,0,0,0  A FLOATING POINT 1
RADIX0 DATA >0000,0,0,0  A FLOATING POINT 0

H01 DATA 1           A "1"
H02 DATA 2           A "2"

WS BSS 32             MY WORKSPACE REGISTERS

OFTEN BSS 2           HOLD FOR HOW "OFTEN" INTERRUPT ROUTINE IS EXECUTED
COUNT BSS 2         COUNT DOWN TIMER FOR INTERRUPT

HOR BSS 2             HORIZONTAL ACCUMULATOR
VER BSS 2             VERTICAL ACCUMULATOR
FIRE1 BSS 2           FIRE BUTTON #1 STATUS
FIRE2 BSS 2           FIRE BUTTON #2 STATUS

SPD BSS 2             SPEED
SPDN BSS 2            NEGATIVE OF SPEED, EH?

MODE BSS 2           CURRENT MODE SELECTED

*****

JOYSET
LIMI 0               TURN INTERRUPTS OFF, JUST IN CASE
LWPI WS              LOAD IN MY WORKSPACE

LI R0,INTER          ADDRESS OF _MY_ INTERRUPT ROUTINE
MOV R0,>83C4          GIVE IT TO THE "USER DEFINED" INTERRUPT

CLR @FIRE1           CLEAR THE FIRE BUTTON #1 COUNTER
CLR @FIRE2           CLEAR THE FIRE BUTTON #2 COUNTER

CLR R0               ARRAY ELEMENT ZERO
LI R1,1              FIRST ELEMENT IN LINK LIST
BLWP @NUMREF         GET THE FLOATING POINT NUMBER
BLWP @XMLLNK         LINK TO ROM ROUTINE TO . . .
DATA CFI             CONVERT FLOATING POINT TO INTEGER
MOV @FAC,@MODE       GET THE INTEGER AND COMPARE TO ZERO
JNE JOYSE1           IF NOT ZERO GO ON AHEAD
CLR @>83C4           IT WAS ZERO. TURN "USER DEFINED" INTERRUPT OFF.
JMP JOYSE2           AND RETURN TO BASIC

JOYSE1 CLR R0         ARRAY ELEMENT ZERO
LI R1,2              SECOND ELEMENT IN THE LINK LIST
BLWP @NUMREF         GET THE FLOATING POINT NUMBER
BLWP @XMLLNK         LINK TO ROM ROUTINE TO . . .
DATA CFI             CONVERT FLOATER TO INTEGER
MOV @FAC,R1          MOVE SPEED INTO R1
MOV R1,@SPD          MOVE SPEED INTO "SPD"
NEG R1               GET NEGATIVE OF SPEED
MOV R1,@SPDN         MOVE NEGATIVE OF SPEED INTO "SPDN"

CLR R0               ARRAY ELEMENT ZERO
LI R1,3              THIRD ELEMENT IN THE LINK LIST
BLWP @NUMREF         GET THE FLOATING POINT NUMBER
BLWP @XMLLNK         LINK TO ROM ROUTINE TO . . .
(Please turn to Page 24)

```

**Sensational Prices!!!**

... On Our Most Popular Hardware and Software!!



**COMPUTER WAR**  
from  
**MicroPal®**

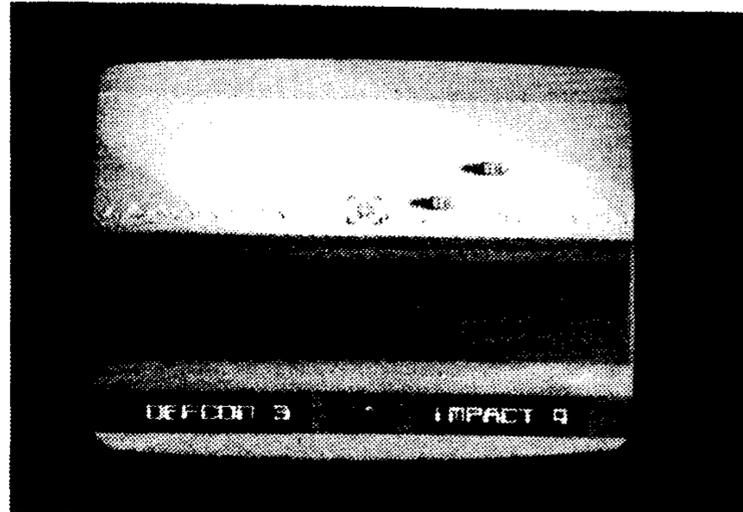
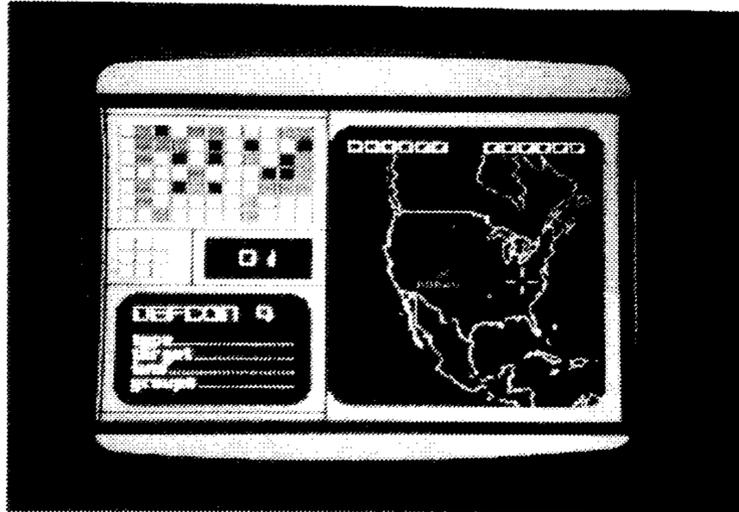

Based on the hit movie "War Games"... this exciting simulation has been a best-seller on diskette — and now it's available from MicroPal® on cartridge! Even if you own just the TI 99/4A console, you can enjoy this new hit. Be prepared for a challenge — as John Koloen at Micropendium observed, "Computer War makes use of multiple screens and is as fast-moving as I can handle."

**COMPUTER WAR.** The alarm bells are ringing at NORAD! Can you crack the code and destroy the simulated enemy missiles before the world is engulfed in a thermonuclear holocaust?

42480 ..... Sug. Retail \$29.95 **\$24.95**

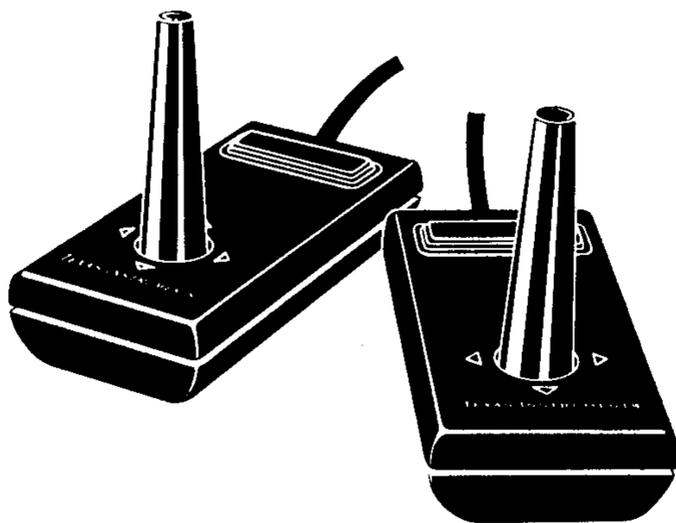

**ORIGINAL TI  
DUAL JOYSTICKS**  
Only **\$8.95**

At this price you should pick up a spare pair!

15499 ..... **\$8.95**

AVAILABLE FROM  
YOUR FRIENDS AT

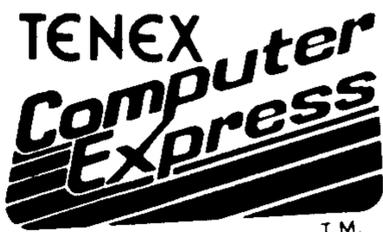

*We gladly accept  
mail orders!*

P.O. Box 6578  
South Bend, IN 46660

**Questions? Call  
219/259-7051**

SHIPPING CHARGES	
ORDER AMOUNT	CHARGE
less than \$20.00	\$3.75
\$20.00-\$39.99	4.75
\$40.00-\$74.99	5.75
\$75.00-\$149.99	6.75
\$150.00-\$299.99	7.75
\$300 & up	8.75

Foreign Orders add \$4.00.  
Heavy items ship at actual cost.

Ad  
M4Z

**NO EXTRA FEE FOR CHARGES**



*We verify charge card addresses*

**ORDER TOLL FREE  
1-800-348-2778**  
INDIANA 1-800-225-6838

## SPRITE—

(Continued from Page 22)

ton presses. The ALPHA lock must still be up to enable upward motion.

To use these routines type in the assembly source code listing, assemble it using only the "R" option, and then load it into Extended BASIC by typing:

```
CALL INIT
CALL LOAD("DSKn.filename")
```

Because these routines use the interrupts they may not work correctly with other assembly routines that also use interrupts.

The main routine is JOYSET. It is called as follows:

```
CALL LINK("JOYSET",MODE,SPEED,OFTEN)
```

The mode is a value from 0 to 3 and is as follows:

- 0 turn off the interrupt routine
- 1 control sprite No. 1 with joystick No. 1
- 2 control sprite No. 2 with joystick No. 2
- 3 numbers 1 and 2 above combined

The speed is a number between 1 and 127 indicating how fast the sprite will move. This value is the same as used in Extended BASIC's CALL SPRITE statement.

OFTEN indicates how often the interrupt routine that moves the sprite should be executed. It must be greater than zero. A value of 1 indicates that the joystick will be checked every 60th of a second. A value of 2 will check every second 60th of a second, 3 every third 60th, and so on. The lower the number, the greater the degree of control the user will have over the sprite. However, greater control also means that the Extended BASIC program will run somewhat slower.

There are two routines that tell whether the fire button has been pressed since the last time either JOYSET or the FIRE routine was called. This means that a press of the fire button will not be missed because the FIRE

(Please turn to Page 26)

## JOYSET

(Continued from Page 22)

```
DATA CFI          CONVERT FLOATER TO INTEGER
MOV  2FAC,2OFTEN  MOVE THAT NUMBER TO THE HOW "OFTEN" VARIABLE
MOV  2FAC,2COUNT AND ALSO INITIALIZE THE COUNT DOWN "COUNT"

JOYSE2
LWPI GPLWS        LOAD BACK THE GPL REGISTERS
B    2)006A       AND RETURN TO XBASIC

*****

FIRE1
LWPI WS           LOAD MY WORKSPACE
LI   R5,FIRE1    MAKE R5 POINT TO FIRE BUTTON #1 COUNT
JMP  FIRE        JUMP TO MAIN FIRE ROUTINE

FIRE2
LWPI WS           LOAD MY WORKSPACE
LI   R5,FIRE2    MAKE R5 POINT TO FIRE BUTTON #2 COUNT

FIRE
MOV  *R5,R6       GET THE FIRE BUTTON COUNT
CLR  *R5          AND CLEAR THE FIRE BUTTON COUNT

LI   R3,RADIX1    MAKE R3 POINT TO A FLOATING POINT "1"
MOV  R6,R6        IS FIRE BUTTON COUNT ZERO?
JNE  FIREA        NOPE. SO SENDING BACK A "1" IS CORRECT. SO SKIP AHEAD
LI   R3,RADIX0    MAKE R3 POINT TO A FLOATING POINT "0"

FIREA
LI   R7,FAC       R7 POINTS TO THE "FLOATING POINT ACCUMULATOR"
LI   R8,4         WE HAVE 4 "WORDS" TO MOVE

FIREB
MOV  *R3+,*R7+    MOVE A WORD AND INCREMENT BY TWO BOTH POINTERS
DEC  R8           DECREMENT WORD COUNTER
JNE  FIREB        IF NOT DONE . . KEEP ON MOVING

CLR  R0           ARRAY ELEMENT ZERO
LI   R1,1         FIRST ELEMENT IN LINK LIST
BLWP 2NUMASG      ASSIGN THE NUMBER

JMP  JOYSE2       RETURN TO BASIC

*****
* THIS IS THE INTERRUPT ROUTINE

INTER LIM1 0      TURN OFF THE INTERRUPTS OR EVERYTHING WILL BLOW UP!

DEC  2COUNT     DECREMENT THE COUNTER
JNE  INTBYE      IF NOT ZERO THEN RETURN
MOV  2OFTEN,2COUNT OTHERWISE RE-INITIALIZE THE COUNTER

LWPI WS          LOAD IN MY WORKSPACE

MOVB 2-31878,R0  GET NUMBER OF SPRITES IN MOTION
SRL  R0,8        MAKE IT A WORD
CI   R0,2        COMPARE IT TO "2"
JGT  INTER0      IF MORE THAN TWO SPRITES IN MOTION . . SKIP AHEAD
LI   R0,>0200    GET A TWO TO . . .
MOVB R0,2-31878 FORCE TWO SPRITES TO BE IN MOTION

INTER0 C 2MODE,2H02 COMPARE THE MODE TO 2
JEQ  INT1        IF MODE IS TWO . . DON'T DEAL WITH JOYSTICK #1

CLR  R10         OFFSET INTO SPRITE MOTION TABLE
LI   R1,>0600    JOYSTICK #1 CRU ADDRESS
BL  2INTSUB      SCAN JOYSTICK

INT1 C 2MODE,2H01 COMPARE THE MODE TO 1
JEQ  INT2        IF MODE IS ONE THEN DON'T DEAL WITH JOYSTICK #2

LI   R10,4       OFFSET INTO SPRITE MOTION TABLE
LI   R1,>0700    JOYSTICK #2 CRU ADDRESS
BL  2INTSUB      SCAN JOYSTICK
```

(Please turn to Page 26)



## ANNOUNCING MYARC'S 640K RAM

# GENEVE t.m.

## MODEL 9640 FAMILY COMPUTER

This unit is without a doubt the most sophisticated machine ever offered in the family and small business area to date. With over a year of design and development, including input from more than one hundred users, this machine has surpassed even our own expectations. Take a moment to review some of the many features that place this computer in a class of its own.

\* **99/4(A) COMPATIBLE  
RUNS OVER 100 EXISTING  
TI CARTRIDGE PROGRAMS**

\* **99/4(A) COMPATIBLE  
RUNS OVER 95% OF ALL  
ASSEMBLY LANGUAGE  
PROGRAMS & UTILITIES**

\* **TI-WRITER NOW A FULL  
80 COLUMNS**

\* **MULTIPLAN ALSO 80 COLUMNS**

### LARGER

Standard 640K RAM  
2 MEGAGYTES Addressable RAM  
MYARC Memory Card Compatible  
With MYARC 512K Card,  
Supplies 1.1 MEGABYTES RAM

**IBM TYPE KEYBOARD** Included

### FASTER

At Least 2 - 3 Times

### PHONE TYPE CABLE

Replaces Old Hex Bus Cable

### MOUSE SUPPORT

\*\*\*\*\*

- Separated Function Keys
- Incredible Graphics Capabilities
- Basic 3.0
- Composite Video Output
- RGB Output
- 128K VDP RAM Memory
- 40 Column Display
- 80 Column Display
- Mouse Output Port
- Joystick Port
- Sound Compatible & Expandable
- Speech Included
- Compatible with Existing Peripheral Cards\*
  - Disk Controllers\* (MYARC, TI, Corcomp)
  - RS232 Cards\* (MYARC, TI, Corcomp)
  - MYARC Memory Expansion Cards Add Directly to RAM (modification required)
- True Hardware Utilities
  - Sprites, Fills, Lines, Data Moves
- TI 9995 Processor Chip - 12 MHz
  - 256 Bytes ULTRA High Speed on Chip RAM
  - Pre-fetch on Instructions
  - Post-store on Instructions
- More RAM Memory than any machine in its price class

*For further information, contact your nearest dealer.*

If unknown, contact MYARC (201) 766-1700 for dealer information.

## SPRITE—

(Continued from Page 24)

routine was not called exactly when the button is down. The routines are called FIRE1 and FIRE2 for joystick 1 and 2, respectively. They are called by:

```
CALL LINK("FIRE1",F)
CALL LINK("FIRE2",F)
```

F will equal 0 if that fire button has not been pressed and 1 if it has.

The first program listing is a very primitive drawing program. Use the fire button to clear the screen. The second program is a simple game. The object is to collect the numbers from 1 to 4 in order while avoiding the drifting ships. Collect a number by moving the ship (starts at the top) over the number and press the fire button. These programs illustrate various simple uses of these routines. I am very interested in seeing what others can accomplish with these routines.

In a future article I will provide a set of routines for doing automatic coincidence checking as these routines do automatic sprite/joystick control.

The source code, object code, and demonstration program may be downloaded from BCS TI99 BBS No. 2 at (617)335-8475 operating 24 hours a day at 300/1200 baud with TE2 and Xmodem transfers. To obtain the files on disk send \$3 to: Boston Computer Society; TI99 User Group; ATTN: J. Peter Hoddie; One Center Plaza; Boston, MA 02108.

**CHECKBOOK DATABASE**

For ALL Checking Accounts. Control Spending. Keep Accurate Tax Records. Balance Checkbook.

★ MINIMUM KEYSTROKE Data Input.

★ LIST and TOTAL CHECKS:

- For a specified PAYEE NAME
- For a DATE Range (from/to)
- For a CHECK NUMBER Range (from/to)
- If TAX DEDUCTIBLE
- Any Combination of the above

★ LIST and TOTAL Deposits, Interest, and Bank Charges for a DATE Range.

TAPE version requires Mini Memory. Allows 400 Checks and 53 Deposits per year.

DISK version requires X Basic and 32K. Printer optional. 700 Checks and 84 Deposits per year.

Send \$12.95 for TAPE, or \$14.95 for DISK to:

**FINE LINE SOFTWARE**

3 Wendy Lane, Marlboro, N. J. 07746

## JOYSET

(Continued from Page 24)

```
INT2      LWPI GPLWS      LOAD BACK THE GPL REGISTERS
INTBYE RT      RETURN FROM INTERRUPT ROUTINE

*****

INTSUB

MOV R1,R5      MAKE A COPY OF R1 FOR LATER USE
LI R12,>0024    CRU COLUMN SCAN ADDRESS
LOCR R1,3      TELL CRU THIS

LI R12,>0006    CRU ROW SCAN
STCR R3,8      GET THE BITS
INV R3         INVERT THEM (THEY COME BACK INVERTED)
JEQ SUBEX      IF THE ARE ALL RESET . . GET OUT . . NOTHING HAPPENED

CLR 2HOR      CLEAR HORIZONTAL ACCUMULATOR
CLR 2VER      CLEAR VERTICAL ACCUMULATOR

TB 0          TEST BIT FOR FILE BUTTON
JEQ NEXT1     NOT PRESSED . . GO ON
CI R5,>0600    IS THIS JOYSTICK #1?
JNE NEXT0     NOPE. SET FOR FIRE #2
SET0 2FIRE1   SET FIRE #1
JMP NEXT1     SCAN JOYSTICK FIRE LINES
NEXT0 SET0 2FIRE2 SET FIRE #2

NEXT1 TB 1      TEST BIT FOR DOWN
JNE NEXT2     NOPE . .
A 2SPD,2VER   YUP . . ADD IN DOWN

NEXT2 TB 2      TEST BIT FOR UP
JNE NEXT3     NOPE . .
A 2SPDN,2VER  YUP . . ADD IN UP

NEXT3 TB 3      TEST BIT FOR LEFT
JNE NEXT4     NOPE . .
A 2SPDN,2HOR  YUP . . ADD IN LEFT

NEXT4 TB 4      TEST BIT FOR RIGHT
JNE NEXT5     NOPE . .
A 2SPD,2HOR   YUP . . ADD IN RIGHT

NEXT5
LI R0,>0780    ADDRESS OF SPRITE MOTION TABLE IN VDP MEMORY
A R10,R0      ADD IN OFFSET
ORI R0,>4000   TELL THAT WE WANT TO SET WRITE ADDRESS
SWPB R0       GET LOW BYTE
MOVB R0,2VDPWA FEED IT TO VDP
SWPB R0       GET HIGH BYTE
MOVB R0,2VDPWA FEED IT TO VDP
NOP          WAIT FOR LAST STATEMENT TO BE "FINISHED"
MOVB 2HOR+1,2VDPWD PASS THE HORIZONTAL VELOCITY
NOP          WAIT FOR THAT TO FINISH
MOVB 2VER+1,2VDPWD PASS THE VERTICAL VELOCITY

SUBEX RT      AND RETURN

END
```

**Demonstration 1**

```
100 CALL CLEAR :: CALL LINK("JOYSET",1,14,2):: CALL SPRITE(#1,42,16,81,81)
110 CALL POSITION(#1,X,Y):: IF X<10 OR X>182 THEN CALL LOCATE(#1,100,Y):: GOTO 110
120 IF Y<10 OR Y>248 THEN CALL LOCATE(#1,X,100):: GOTO 110
130 CALL LINK("FIRED1",F):: IF F THEN CALL CLEAR
140 CALL HCHAR(INT((X+3)/8)+1,INT((Y+3)/8)+1,42):: GOTO 110
```

Please turn to Page 28 for Demonstration 2 program

# AT LAST—A COMPLETE PRINT SHOP PACKAGE FOR THE TI-99/4A

## THE PRINTSHOPPE 99™ Desktop Publishing System

Now create your own newsletters, advertisements,  
signs and greeting cards with this new package.

**INCREDIBLE NEW FONTS**  
**TINY LARGE WEIRD SLANTED**

**FOR ALL OCCASIONS**

CLIPART AND PICTURES TOO!!

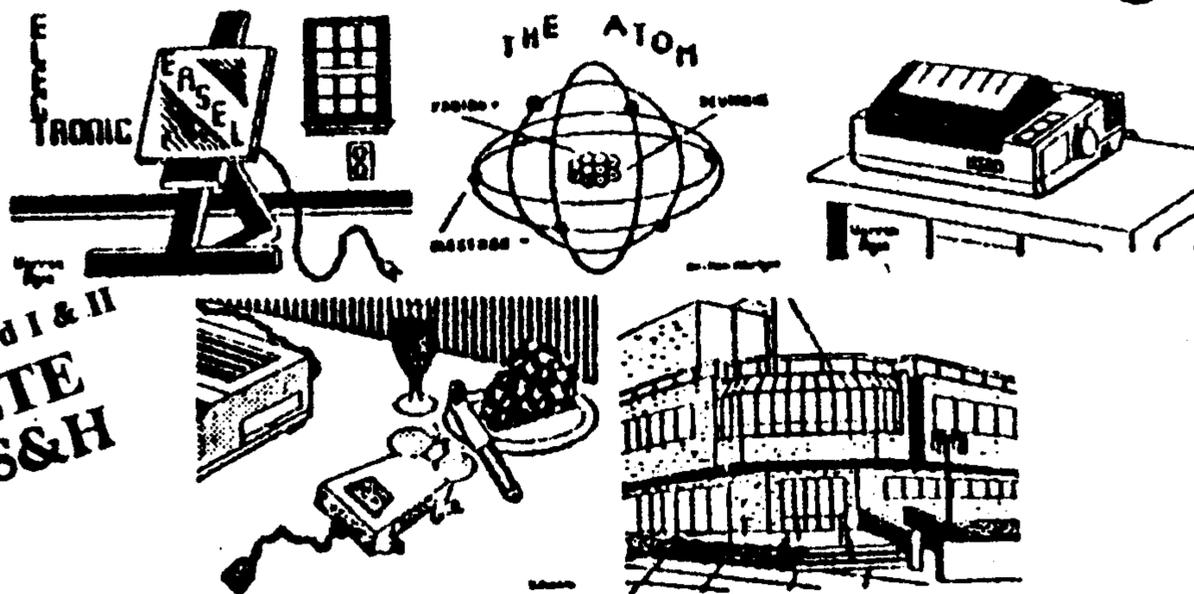

GRAPHX & Asgard I & II  
**COMPLETE**  
**\$47.95 + S&H**

### PACKAGE INCLUDES GRAPHX + 4 COMPANION DISKS

Tex-Comp has gone all the way to Australia to directly import the latest extended basic version of GraphX and has combined it in a user-friendly package with 4 outstanding companion disks from Asgard, which are filled with 24 sets of fancy typestyles (fonts) and a huge collection of clip art pictures which can be printed out to make labels, illustrations, letterheads, etc. The companion disks contain a total of 14 clip art files with each file containing an assortment of different pictures.

By using GraphX together with these 4 companion disks, you'll have the ability, not only to create your own graphics, but also an outstanding collection of ready-to-use illustrations & typestyles. Requires 32K, disk drive, joystick and Epson or Star compatible printer.

**ADD \$7.95 for the newly released Companion Disks III by Asgard**  
**MANY MORE TYPE FONTS, CLIP ART AND SPECIAL FEATURES!!!**

Send order and make checks payable to:

**TEX+COMP**

P.O. BOX 33064—GRANADA HILLS, CA 91344



AUTHORIZED DEALER



VISA and MASTERCARD  
HOLDERS CALL DIRECT  
**(818) 366-6631**  
24 Hour Order Line

**TERMS:** All prices F.O.B. Los Angeles. For fastest service use cashiers check or money order. Add 3% shipping and handling (\$3.00 Minimum). East of Mississippi 4 1/2%. Add 3% for Credit Card orders. Prices and availability subject to change without notice. We reserve the right to limit quantities.

**NOTE:** Payment in full must accompany all orders. Credit card, Company check or Money order for immediate shipment. Personal Checks require up to 4 weeks to clear. California orders add 6 1/2% sales tax.

©1986 TEX-COMP

SEND \$2.00 FOR NEW 1986 CATALOG WHICH INCLUDES A \$5.00 SAVINGS CERTIFICATE.





from

Texas Instruments TMS-400 COMP. PERIPHERALS AND SOFTWARE  
**TEX+COMP™**  
America's Number One Ti computer retailer



**TEX-COMP** brings you special pricing on 3 of the **hottest** children's games ever produced for any computer at a **special holiday savings!**



# "THE MAGNIFICENT THREE"

Three spectacular software cartridges just in time for holiday giving

**ALL 3 for ONLY \$17<sup>95</sup>** (Regularly 9<sup>95</sup> each)



### Story Machine

Helps children write sentences, paragraphs, even simple stories while learning the parts of speech



### Burger Time

One of the hottest arcade games in its original razzle-dazzle format. Your chef, Peter Pepper, is surrounded by pickles and hot dogs. Dodge 'em, pepper 'em, lead 'em down ladders and onto a bun before they make you the main course



### Facemaker

Creative fun for children ages 5 to 7. Provides very simple introduction to programming and familiarity with keyboard



**Order the Complete "Magnificent Three"**

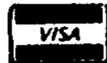

VISA and MASTERCARD HOLDERS CALL DIRECT (818) 366-6631

SEND ORDER AND MAKE CHECKS PAYABLE TO

**TEX+COMP™**

P.O. BOX 33084 GRANADA HILLS, CA 91344

Texas Instruments



AUTHORIZED DEALER

**TERMS:** All prices FOB Los Angeles. For fastest service use cashiers check or money order. Add 3% shipping and handling (\$3.00 minimum). East of Mississippi 4 1/2% (Free shipping on all software orders over \$100.00). Prices and availability subject to change without notice. We reserve the right to limit quantities.

**NOTE:** Payment in full must accompany all orders. Credit Card, Company Check or Money Order for immediate shipment. Personal checks require up to 4 weeks to clear. California orders add 6 1/4% sales tax.

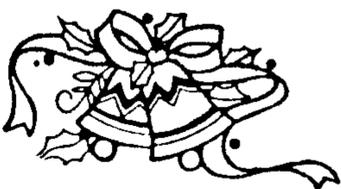

# Survey details Freeware attitudes

By JIM SWEDLOW

As a Freeware author, I have been curious to know about the experiences of others in this category. Recently I sent out a survey to the 42 Freeware authors listed in the then-current MICROpendium; 32 (75 percent) responded, representing a cross section of Freeware offerings.

In the survey form I asked for responses on a scale of 1 to 5. Thus, if 1 represents "very dissatisfied" then 2 is "dissatisfied" and if 5 is "very satisfied" then 4 is "satisfied." Hence, a response of 4 or 5 would be satisfied and 1 or 2 would be dissatisfied.

In the discussion of product distribution, the number of products is higher than the number of responses as some authors had more than one item.

The average item has been out 10.2 months or a median of eight months. It has been shipped to an average of 99.6 persons or a median of 56. Eight programs (20 percent) had 100-199 copies sent and seven (17 percent) had 200 or more. The remainder (63 percent) were requested fewer than 100 times.

Authors averaged 2.5 hours per week sending out their product.

and "no amount specified" (28 percent). Authors reported getting some response 82 percent of the time. The average number of responses was 31.4 (the median was 10).

They strongly opposed the name "Freeware" with 86 percent finding it misleading. "Fairware was the favorite:

Fairware	48 percent
Tryware	13 percent
Shareware	14 percent
Freeware	10 percent
Other	14 percent

The "Other" suggestions were Userware, Econoware, PaymentOptionalWare and Trustware. The name Tryware included Try&BuyWare.

Opinions regarding the role of users groups were:

Approach	Support	Oppose
Users group collects fee only for users group costs	69%	27%
Users group collects fee for author and sends to author	26%	52%
Users group financially supports authors some other (unspecified) way	52%	44%

User sends cash OR disk and postage-paid mailer 32%

User sends cash OR disk, postage-paid return mailer and cash 61%

Generally, they felt that when the author provides the disk and mailer the fee should be in the \$5-\$10 range and when the user provides the disk and mailer the fee should be \$2 to \$7 (if any).

Fairware authors were evenly divided on the question of the workability of "get now—pay later." By a 56 percent to 44 percent margin, they said it can work. Regarding the various systems, they said:

No later fee requested 7%

Payment requested if user likes the program 52%

User becomes registered owner if payment is sent and then gets documentation and/or notices of updates and/or support 30%

Payment must be "up front" or before shipment 11%

This is what they thought was important about Freeware:

Item	Important	Unimportant
Sharing their program with others	90%	7%
Supporting the 4A	87%	0%
Communicating with other owners	65%	16%
Money	23%	48%
Recognition	27%	57%
Receiving programs with orders	30%	43%

They rated their satisfaction with their participation as follows:

Item	Happy	Unhappy
Response to their offer	48%	19%
Communication with other owners	61%	13%
Net profit	27%	37%

(Please turn to Page 32)

## ADVERTISING FREEWARE

Method	Effective	Ineffective	Number Using
MICROpendium	83%	8%	36
Bulletin boards	0%	86%	14
Letters to users groups	0%	89%	9
Users group announcements	25%	60%	20
Compuserve	25%	50%	8
The Source	0%	100%	1 (!)

The only effective method of advertising Freeware was MICROpendium, according to results shown in the accompanying chart.

Most authors (84 percent) asked for payment if the user was satisfied with the product. The amounts requested were: \$5 (31 percent), \$10 (41 percent)

Positions regarding what the user must pay for receiving a copy of the offering were:

User sends disk and postage-paid return mailer (not provided by author) 4%

User sends only cash—author always provides disk and mailer 4%

## Freeware Update

Described below are recent additions to the MICROpendium Freeware listing. Freeware is user-supported software, and MICROpendium takes no responsibility for the effectiveness or usefulness of any Freeware item. MICROpendium encourages contributions to Freeware authors as an incentive to provide additional software support for the TI community.

Unless otherwise noted, always send a self-addressed, stamped return mailer and required media when ordering Freeware. Allow 4-6 weeks for delivery. Anyone with a problem regarding a Freeware transaction is encouraged to contact MICROpendium.

### PROGRAMS FOR TESTING

Charles E. Kurzhal, of 7361 MUNSS Box 1013, APO NY 09145, is offering a three-program package for creating, managing, printing and taking user-written tests. Included is a TI-Writer file of instructions and a short sample test. Send 1 SSSD diskette, etc. For \$9.50 the author will supply the diskette and return mailer.

### ACCOUNTING, FORTUNE TELLING

Leo W. Du Bry, of 325 S. Center, Longview, TX 75601, is offering two programs: Accounting and George Tells a Fortune. Both require Extended BASIC and a printer.

The accounting program features a 16-column worksheet and allows for use with up to four bank accounts. User inputs column titles, enters check numbers, business names and amounts. Printout provides details on transactions. Data is saved to disk for future use. George Tells a Fortune displays a series of playing cards on the screen and prints explanations of their meaning on a printer.

### SONGS, VCR MOVIE GUIDE

Bill Knecht, of 815 Yorkshire, Pasadena, TX 77503, is offering his Best Songs 2 and VCR Movie Guide as Freeware.

Best Songs 2 requires XBASIC and a memory expansion. Included are 12 songs with graphics and sing-a-long words. Titles include I'll Never Fall in Love Again, Bridge Over Troubled Waters and How Firm a Foundation.

VCR Movie Guide is used to catalog a movie collection. Inputs include title, rating, playing time, tape number, tape counter number. The program can handle up to 175 movie entries per file with area for nine files. Searches are conducted on basis of a keyword in the title or by rating. Display modes include fast scan of all entries, slow scan or scan and abort. Catalog lists may also be printed.

To order, send \$5 for each program or \$8 for both.

### THE DOORS TO EDEN

L. Steven Cheairs, P.O. Box 27547, Albuquerque, NM 87125, is offering two adventure games: The Doors to Eden and First Days in Eden. The TI Adventure module is required. Both games function like a Scott Adams adventure.

The Doors To Eden involves a player who wanders about

(Please turn to Page 32)

# JOY PAINT

(C) Copyright 1986

Sophisticated. Easy to use.

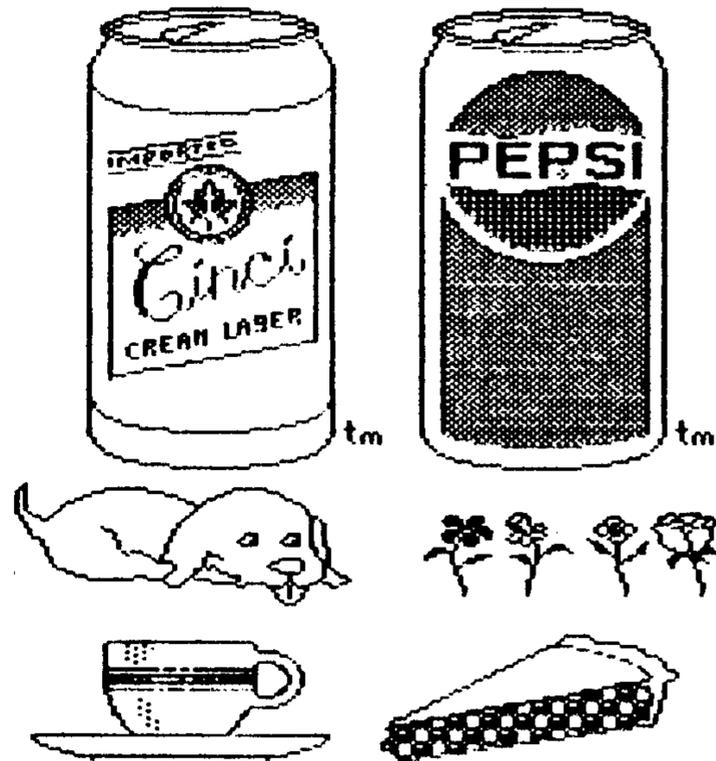

These graphics and hundreds more are included!

Paint and fill using 26 patterns or make your own! Print graphics to TI or Epson Compatible, Gemini 10x, S610, SD10, Spirit 80 or Axiom GP-100 TI! Requires: TI 99/4a, 32k, Disk Drive, Joystick, and one of the following: Ed/Assm, Ex-Basic, Mini-Memory, or TI-Writer.

\$ 39<sup>95</sup> Postpaid

Write for information on our other programs!

- Extended Business Graphs
- Joy Paint Pal
- The Directory
- Quadruple Dump

Personal check or money order accepted. Orders shipped via 1st class U.S. mail.

## GREAT LAKES SOFTWARE

804 E. Grand River Ave.

Howell, MI. 48843

THIS ADVERTISEMENT WAS CREATED USING JOY PAINT 99!

# Most authors would do it again

By JIM SWEDLOW

With some freeware authors withdrawing their product in disgust and others expressing happiness, it was difficult to tell what was happening with freeware.

I decided to do a survey. I contacted

42 authors—everyone listed in the then current issue of MICROpendium and a few others. More than 75 percent responded. What they had to say bears directly on the future of the 99/4A!

While 47 percent of the authors were happy with their overall participation

in freeware, a resounding 81 percent would still have released their program even if they knew what would happen. MICROpendium was the only effective method of publicizing freeware.

Some 84 percent of freeware authors  
(Please turn to Page 33)

## UPDATE—

(Continued from Page 31)

looking for clues to solve the adventure. The setting is a large desert. Upon completing the game an access code is given that is used to play the second game, First Days in Eden. This second game allows no movement and is set in a garden in which the player holds a "conversation" with a man. The man questions the player about the first game and, when he is convinced that the player fully explored and solved The Doors to Eden, the player receives another access code that is used to start a third game called The Garden of Eden Reclaimed. The third game has yet to be released.

The author asks for a \$2 donation at the time the games

are ordered. Send either two disks or two cassettes with stamped return mailer.

### SPRINT UTILITY

Ken Houle, of 27721 W. Wakefield Rd., Saugus, CA 91350, is offering SPRINT as Freeware. The program is a utility for assembly language programmers. It reads the variable 80 source file created by the Editor/Assembler editor and will dump it to a printer or disk. Payment of some sort would be appreciated, Houle notes.

### FUNPLUS!

Jack Sughrue, Box 459, E. Douglas, MA 01516, is offering a disk of templates, utilities, tutorials, reviews and programs that allow users to access some of the power within the Funwriter- DM1000 structure. Called FUNPLUS!, the disk includes an active cataloguer that allows printing, deletion, loading, etc.; a banner program, desk calendar, labelmaker, presentation program, templates for borders, boxes, letterheads, etc., transliteration codes for use with TI-Writer and quick reference charts. Also included is version 2.3 of DM1000. Memory expansion is required.

Sughrue asks for \$8. He will provide postage, mailer and media.

### BACKYARD POND

Dave Dalton, of 920 Hillview Dr., Marion, IA 52302, is offering a game for children called Backyard Pond. The object is to adopt the identity of a fish and survive against other fish. Send disk and stamped return mailer.

### PRINTOUT

Steven D. Mehr, of 633 Hollyburne Lane, Thousand Oaks, CA 91360, is offering an XBASIC utility that provides a variety of options for printing display variable 80 files to Epson or Gemini compatible printers.

The program features normal, emphasized, double-strike or condensed printing, the ability to alter line spacing, the ability to print text or graphics files, printing of multiple copies or files, printing of D/V 80 or D/F 80 files, optional form feeds between files and a disk catalog option.

Mehr is asking for a \$5 donation for his program. Include a disk and return mailer and postage.



*The*  
**HORIZON  
RAMDISK**

**192K RAM  
BATTERY-BACKED**

**\$53\* PC Board, Manuals & Software**  
**\$45\* Five or more boards with one manual and set of disks.**

\* PARTS AVAILABLE ELSEWHERE FOR ABOUT \$100/720 Sector  
OHIO RESIDENTS ADD 5.5% SALES TAX

**CONSTRUCTED - 90 DAY WARRANTY**

192K - 720 Sector .....	\$210
104K - 360 Sector .....	\$165

**EASY TO USE...**

- > Functions just like a TI floppy drive, only FASTER! Load the operating system with a single key press, then access the RAMDISK as you would a floppy disk.
- > Compatible with software using standard DSRLNK including sector copy, Disk Manager II, MG Explorer, TI Writer, TI Multiplan, and Editor/Assembler. Compatible with TI BASIC, TI Extended BASIC, TI and Wycove FORTH, TI LOGO, and Assembly Language.
- > Comes with the DM-1000 Disk Manager. Loads from BASIC of Ext BASIC in 1 second with CALL DM.
- > Compatible with existing hardware including MAXIMEM, GramKracker, and the RAM/GRAM Card.
- > Accepts drive names from DSK1 to DSK6.
- > DIP switch sets CRU Base from >1000 to >1700.
- > Adds CALL Subprograms to BASIC to 1) set the drive number, 2) set write protect, 3) set maximum sectors, 4) enable DSR for direct access, 5) execute M/L code from BASIC. DELETE "XBCALL" downloads CALLs to low BK for execution from running Ext BASIC programs.
- > Comes with complete DSR SOURCE CODE. Explains how to write A/L CALL routines to enhance TI BASIC.

**HORIZON COMPUTER LIMITED**  
P.O. Box 554  
Walbridge, Ohio 43465

NOT JUST ANOTHER RAMDISK...

THE ONLY BATTERY-BACKED RAMDISK for the TI-99/4A. The on-card batteries recharge when you operate your computer. The batteries will last for years and the entire 192K RAM memory is battery-backed including the DSR RAMDISK Operating System.

THE ONLY FULLY OPEN PE-BOX CARD. The Horizon RAMDISK contains no EPROM or ROM. The DSR Operating System is in RAM and is loaded from a floppy disk. DOCUMENTED SOURCE CODE is provided for those who wish to understand AND MODIFY the Operating System.

THE ONLY PERIPHERAL WITH DSR RAM which allows the assembler language programmer to write Device Service Routines. The Horizon RAMDISK memory is decoded entirely within address space >4000 to >5FFF. A special loader (provided with SOURCE CODE) enables AORG Editor/Assembler object files to be placed in the RAM on the card. You can write all new CALL subprograms for TI BASIC, power-up and interrupt service, and DSR routines making use of the 192K battery-backed RAM. >4000 to >57FF is always enabled, and the remaining 186K is paged in 2K at a time in >5800 to >5FFF with the LDCR instruction.

THE ONLY RAM CARD YOU CAN BUILD your self at substantial savings over fully constructed models. You can buy the printed circuit board, user's manual, Operating System software, and an ILLUSTRATED step-by-step construction manual with schematic and parts list and get the parts wherever you can find the best deals. Hundreds of TI Enthusiasts have built the Horizon RAMDISK. If you've had any experience building electronic kits you can too -- at SIGNIFICANT SAVINGS! (If you want a fully constructed, tested and warranted unit, we sell those too.)

## FREWARE—

(Continued from Page 32)

asked for a contribution if the user liked the program. In this sense, freeware is unique to the computer world. It allows the user to get software and to evaluate it before purchasing it. It also allows, in fact encourages, users to make free copies for other potential customers. The risk is borne completely by the person marketing the software.

The responses pointed to some changes that could improve freeware.

First is the name Freeware. There is strong support among authors for a change. Not only can it be misleading, but it is trademarked by Andrew Fluegelman, author of PC TALK (for the IBM). While many alternate names were suggested, the clear favorite of authors is Fairware.

If there was one area that generated more discussion than any other, it was the role played by users groups. Many authors believe that users groups can play a much stronger role in supporting fairware and our computer.

TI discontinued the 4A three years ago. We can take pride that not only are we still a viable member of the computer fraternity but that we have better products today than were available in 1983. Any set of comparisons would have glaring omissions but the difference between Disk Managers II, 1000 and IV tells the tale.

Our success is the result of the dedication and support of publications, vendors, commercial soft/hardware producers, fairware authors, user groups and, last but certainly not least, owners.

## SURVEY—

(Continued from Page 30)

Overall reaction to participation 47% 20%

Given all this, a resounding 82 percent would still have released their program now even knowing what was going to happen.

If we are to continue to be this strong on the fifth anniversary of Black Friday, user groups must reconsider their priorities. Although the following points deal with fairware, they apply to all the elements of the 4A's survival network.

It simply is not enough for user groups to distribute fairware and public domain programs through their libraries. It is worrisome that fairware authors report that programs and announcements sent to user groups resulted in absolutely no response.

There are many things that user group can do to help ensure that fairware is supported. Some suggestions are: member education, fairware reviews in newsletters, publicizing new offerings and direct support of fairware authors.

Some user groups are doing innovative things to support the 4A. Others are considering new ideas. If we share our ideas, our successes and our problems, we can help encourage others to act. This can be accomplished by articles in newsletters and letters to MICROpendium and other 4A publications.

It is not fairware that is at stake here, it is our 99/4As. We have done quite well in the last three years without any concerted effort. If we want this to continue, we must start planning and acting, starting now!

**NOVA**  
COMPUTERWARE  
52 AIRPORT ROAD EDMONTON  
ALBERTA T5G 0W7  
(403) 452-0372

**TI 99/4A**  
CHRISTMAS  
SPECIALS

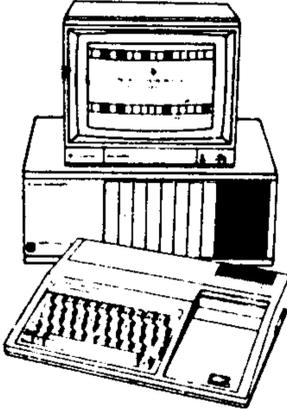

CANADA MAIL ORDER  
VISA, MONEY ORDER, COD OR CHEQUE

**COMPLETE BBS SYSTEM**  
**\$110.00**

The most complete bulletin board  
system written for your TI home  
computer.

**INCLUDES 3  
TRANSFER PROTOCOLS**

1. TELL  
2. XMODEM  
3. XON/XOFF

**TOTAL SYSOP CONTROL**  
Sysop see the board run as if he was  
the user. He can override any user  
input and guide him on the use of  
the board.

**CALL THE BBS AT**  
**(312) 766-2797**  
or write  
**BBS SYSTEM**  
**1411 N. 36TH**  
**MELROSE PARK IL.**  
**60160**

## EXPAND TO RGB

The TI-99/4a is the only Home Computer capable of being upgraded to professional quality RGB display. DIJIT Systems is offering you that capability.

- Experience bright sharp graphics in TI's palette of 16 computer generated colors.
- Reduce eyestrain with text so sharp you can even read the 64 column Forth editor clearly and distinctly.
- Eliminate "rainbow" color bleed distortion and annoying screen interferences from outside sources.

The easy RGB conversion requires:

- |   |           |
|---|-----------|
| 1. MODEL 4A DECODER INTERFACE           | From \$65 |
| Varies according to monitor.            |           |
| 2. CONSOLE CONVERSION KIT               | \$35      |
| Not required for overseas PAL consoles. |           |

An ANALOG RGB monitor is needed to display the full color range, preferably 80 column rated.

SANYO DMC 6500/7500; SEARS 4084 \$15  
ANALOG RGB CONVERSION KIT

We have super deals on monitors. Send for our list of recommended models and prices.

### OTHER DIJIT Systems PRODUCTS

- |   |      |
|---|------|
| MONITOR ALIGNMENT SOFTWARE                          | \$20 |
| Creates test patterns for monitor and TV alignment. |      |
| CACHE CARD  | \$35 |
| Our own version of "supercart".                     |      |
| MINI MEMORY LITHIUM CELL                            | \$5  |
| Exact replacement battery.                          |      |

For RGB CONVERSION KIT include \$4.00 S/H. CA. Residents include 6% sales tax. Send check or money order only.

To order or for information

Write to:

**DIJIT Systems**  
**4345 HORTENSIA STREET**  
**SAN DIEGO, CA 92103**  
**(619) 295-3301**

# Cryptography and the TI

First Serial Rights (C) 1986 Sean Sands

By SEAN SANDS

Codes, or ciphers as they are sometimes called, have been in use since early biblical times. Even as kids, each of us had at least a little experience with codes. Naturally, as soon as the first military computers came upon the scene they were immediately used to help in the encoding/decoding process.

The first of these early machines, the Hagelin cryptograph, used rotors inside that turned as the plaintext (message to be encoded) was entered. When the first rotor completed one revolution, the next would click one position, clicking the next rotor forward one after it made one revolution, changing the code each time. These rotors work about the same way as an odometer; after the one's position makes a full revolution it adds one to the ten's, and so on.

The Hagelin machine turned out a polyalphabetic mixed alphabet cipher that would repeat its pattern of coding every 100 million characters! Although the length of the pattern made it difficult to crack, it wasn't impossible. Portions of the key system would overlap at times, giving the cryptographer a clue of the machine's rotor settings.

Soon, though, rotors gave way to electric motors, then to things called stepping switches. Although many of the code computers used today are specially designed for codes, the TI, with its powerful string manipulation commands, can produce some pretty interesting ciphers.

Some of the functions we will be using are described below:

FUNCTION	DESCRIPTION
ASC(char.)	Returns the ASCII code of the character given.
CHR\$(number)	Returns the character corresponding to the ASCII code given.
LEN(string)	Returns the length of the string given.
SEG\$(string, position, length)	Extracts one string from a larger one. You specify the larger string, where to start extracting, and how many characters to extract from the starting point.

We'll start with the basics, with one of the first "codes" you may have used as a child—printing the message backwards. Type in subroutine No. 1 and we can go through the simple algorithm (a procedure that a program uses to solve a problem) that controls this subroutine. (The subroutines may be found at the end of this article—Ed.)

**Variables:** A\$ = Plaintext (contains code upon return).

## LINE NO. EXPLANATION

10000 Initiates a loop that will count backward from the LENgth of A\$ (the plaintext) to one. :: Takes the next letter out of A\$ (counting backwards, remember) and adds it to B\$, processing forwards. :: NEXT I :: Replaces A\$ with reversed plaintext. :: Nulls B\$. :: Returns

The subroutine is very simple, as is the code. Now key in subroutine No. 2 and we'll take it a step further. Pretend that each letter is assigned to a number (in BASIC that is relatively easy, because they are). The next code you may have tried as a kid (we're at about fifth or sixth grade now) would be adding or subtracting a number from the plaintext. The number you add or subtract is known as the deviation.

So, in designing the routine, I had to take some things into consideration. First, if the code drops below "A" I would want it to "wrap around" and finish subtracting from "Z." The same goes for anything above "Z," it has to continue adding at "A."

Two simple formulas can accomplish this:  $C = 64 + ((C + D) - 90)$  and  $C = 91 - (65 - (C + D))$ ; where C equals the ASCII code for the letter being processed and D equals the amount of deviation specified.

In addition to that, I want the subroutine to ignore spaces in the plaintext, to keep the groupings intact. Now let's take a look at the routine:

**Variables:** A\$ = Plaintext (contains code upon return),  
D = Deviation (A negative value subtracts, a positive adds)

## LINE NO. EXPLANATION

10500 Open loop. From one to the LENgth of the plaintext. :: C = the ASCII value of the character being processed.

10510 Checks if C + D exceeds "Z." If it does, it will wrap around and add to "A." If there is a space, then it keeps the space intact. Checks for a value lower than "A," and will wrap around if necessary. If none of the above conditions apply, it will simply add the deviation.

10520 Adds CHR\$(C) to B\$. :: NEXT I :: A\$ = B\$ :: B\$ = "" :: RETURN

Of course, with a simple deviation code such as the one above, all someone would have to do to break the code is raise or lower the plaintext until he finds the right number. In the game of espionage, that's not very good. To ensure the secrecy of our messages, therefore, we must implement a

(Please turn to Page 35)

## CRYPTOGRAPHY—

(Continued from Page 34)

new code. This is where ADC comes in. Alternating Deviation Code has the unique quality of a deviation that alternates between addition and subtraction on every character. In other words, if the deviation is five, the first character would have a five added to it and the next would have a five subtracted from it.

The first problem that comes to mind when designing a subroutine to do this is how to switch from a positive deviation to a negative one repeatedly without having to write a lengthy switching routine. Type in subroutine No. 3 and let's examine the answer.

Actually, the solution is very simple. All one needs to do is insert a small formula just before the "NEXT I," like this:  $D = D * -1$ . For those who don't remember much of algebra (or math in general), a negative times a negative is a positive, and a positive times a negative is a negative. Because of this mysterious mathematical relation, every time the loop passes over this calculation the deviation will be turned into its inverse.

However, after some use, another problem becomes evident. If the subroutine encounters a space, it will alternate (or invert) the deviation as if there was a character there. So here is what would happen:

**Normal encoding:**

Plaintext: TI COMPUTER  
ADC(1): UH DNNOVSFQ

**Encoding with error in subroutine:**

Plaintext: TI COMPUTER  
ADC(1): UH BPLQTUDS

But the solution to this is again, simple. After "IF C = 32 THEN C = 32" we just add " $D = D * -1$ ". This will result in the deviation being inverted twice, returning to the original (no alternation). Here's what it looks like:

**Variables:** A\$ = Plaintext (contains code upon return), D = Deviation (A negative value starts the loop subtracting, a positive adding.)

LINE NO.	EXPLANATION
11000	No change.
11010	IF C = 32 THEN C = 32::D = D * -1 ELSE (...)
11020	Adds CHR\$(C) to B\$. :: Multiplies D to -1, resulting in the inverse of the deviation :: NEXT I :: A\$ = B\$ :: B\$ = "" :: RETURN

As you can see, not much change is required to the regular deviation subroutine to produce ADC. That little change, however, produces a much safer code. But not that safe. To throw anyone who may intercept our messages even farther off track, we will implement ATDC; Alternating Triplicating Deviation Code. When coding ATDC, you must code in groups of three, in this format.

Character 1: Deviation

Character 2: No deviation

Character 3: Deviation \* -1

To do this, we must make some bigger changes to the routine. First, the loop must be changed to increment in twos, allowing us to take one character, deviate it, and leave the second alone. Then we take the second group of two, deviate the first character with the inverse deviation, and leave the next alone. Here is what the subroutine will do:

**Plaintext: COMPUTER**

Two at a time: CO MP UT ER

Take the first two: CO

Add deviation(+ 1): DO (second character is left alone)

Take next two: MP

Add deviation(now -1): LP (Leave second character alone)

After it's all over: DOLPVTDR

But what if the length of the plaintext is an odd number? The loop wouldn't function properly. To fix this the first line will check if it is an odd or even length. If it is odd it will add a space to it to make it even. Type in subroutine No. 4 and we'll see how it works:

**Variables:** A\$ = Plaintext(coded on return),  
D = Deviation

LINE NO.	EXPLANATION
11500	Checks to see if A\$ is of an even length [IF LEN(A\$)/2 = INT(LEN(A\$))/2 THEN]. If it is, it continues; otherwise it adds a space.
11510	C2 = the character after the one specified by the loop.
11520	No change.
11530	Compiles B\$, adding CHR\$(C) to it leaving that "middle" character alone. :: The rest is unchanged.

I hope this article has been informative. Cryptography is a growing science, since one of the key parts of a nation's defense is knowing what the other side is up to. So, I will leave you with a message, a place to send away for more information on codes. This is a tough code, and when you reply, you must send the decoded word at the start of the message. Numbers were not encoded and should not be included in the decoding process.

TCE VMB DOK TGX

NSI VNI VZH  
94 ZKD MYZ OVV ZIJ IN  
XMI LJO NVI DFC OMD I  
02852  
30

(Please turn to Page 36)

# Chicago, Milwaukee host fairs

Chicago's fourth annual TI Faire—the one which sparked many similar festivals all over the country—will be held Nov. 1 at Triton College in River Grove, Illinois.

The Faire will be held from 9 a.m. to 6 p.m. in the Ironwood Room of Triton's Student Center. Triton is at 2200 N. 5th Ave. in River Grove, ¼ mile north of Maywood Park race track.

Demonstrations by Clint Pulley, author of "C"; by Chris Bobbitt of Asgard Software; and by Lou Phillips of Myarc Hardware are scheduled.

Also scheduled are presentations by Al Stump on care and maintenance of the TI, and by J. Peter Hoddie on making music on the TI.

More than 20 vendors have signed

up for the Faire, organizers say.

Admission is \$2 and includes admission to seminars.

For more information Call Grant Schmalgemeir (312) 477-0690 between 10 and 11:30 p.m. Central Time.

## Wisconsin Fair set

A Wisconsin TI Fair in the greater Milwaukee area is scheduled to be held Nov. 2, back-to-back with the Chicago TI-Faire set for Nov. 1.

The Wisconsin Fair will be from 8 a.m. to 4 p.m. at Milwaukee Area Technical College's South Campus, 6885 So. Howell Ave., Oak Creek, Wisconsin and is sponsored by the Wisconsin TI99/4A and the Milwau-

kee Area TI99/4A users groups.

Fair organizers say vendors, seminars and guest speakers are scheduled.

Admission is \$2, \$1 to users group members.

For further information call (414) 535-0133.

## PC PURSUIT to give special offer at Faire

PC PURSUIT will have a booth at the TI Faire in Chicago Nov. 1 with a special offer to Faire-goers waiving the \$25 sign-up fee, according to Rory Binkerd, of the Siouxland 99ers of Sioux Falls, South Dakota.

Binkerd and Bob Daggitt of the Siouxland 99ers will represent the service at the Faire.

PC PURSUIT is a service by GTE Teenet Communications Corp. which lets home computer users pay a signup fee and a set \$25 monthly fee for any number of calls to databases and electronic bulletin boards in specified metropolitan fees during non-prime-time hours, 6 p.m. to 7 a.m. on weekdays and all day on weekends and most holidays. If the service is used during prime time it can cost between \$10.50 and \$14 an hour extra. PC PURSUIT charges are billed to MasterCard or VISA.

The service makes use of the excess capacity of GTE Telenet's data network which provides daytime commercial database access for business.

For further information, call 1-800-368-4215 8 a.m.-5 p.m. Eastern Standard Time Monday through Friday. Binkerd asks that callers mention him.

## Fox UG address

The Fox City Users Group, of Appleton, Wisconsin, changed its mailing address two years ago but confusion remains.

Those who correspond should send their materials to P.O. Box 2553, Appleton, WI 54913-2553.

## CRYPTOGRAPHY—

(Continued from Page 35)

### Subroutine No. 1: String Reversal

```
10000 FOR I=LEN(A$) TO 1 STEP-1
  :: B$=B$&SEG$(A$,I,1):: NEXT I
  :: A$=B$ :: B$="" :: RETURN
```

### Subroutine No. 2: String Deviation

```
10500 FOR I=1 TO LEN(A$):: C=ASC(SEG$(A$,I,1))
10510 IF C+D>90 THEN C=64+((C+D)-90)ELSE IF C=32 THEN C=32
```

```
ELSE IF C+D<65 THEN =91-(65-(C+D))ELSE C=C+D
10520 B$=B$&CHR$(C):: NEXT I
  :: A$=B$ :: B$="" :: RETURN
```

### Subroutine No. 3: Alternating Deviation Code

```
11000 FOR I=1 TO LEN(A$):: C=ASC(SEG$(A$,I,1))
11010 IF C+D>90 THEN C=64+((C+D)-90)ELSE IF C=32 THEN C=32
  :: D=D*-1 ELSE IF C+D<65 THEN C=91-(65-(C+D))ELSE C=C+D
11020 B$=B$&CHR$(C):: D=D*-1
  :: NEXT I :: A$=B$ :: B$="" :: RETURN
```

### Subroutine No. 4: Alternating Tripling Deviation Code

```
11500 IF LEN(A$)/2<>INT(LEN(A$)/2) THEN A$=A$&" "
11510 FOR I=1 TO LEN(A$)STEP+2
  :: C=ASC(SEG$(A$,I,1)):: C2=ASC(SEG$(A$,I+1,1))
11520 IF C+D>90 THEN C=64+((C+D)-90)ELSE IF C=32 THEN C=32
  :: D=D*-1 ELSE IF C+D<65 THEN C=91-(65-(C+D))ELSE C=C+D
11530 B$=B$&CHR$(C)&CHR$(C2)
  :: D=D*-1 :: NEXT I :: A$=B$
  :: B$="" :: RETURN
```



## QUALITY 99 SOFTWARE

- Easy to use
- Fast
- Reliable
- Fully supported

Why take a chance with anything less?

Christmas Sale — on NOW!

For a FREE catalog, call or write:

**QUALITY 99 SOFTWARE**  
**1884 Columbia RD #1021**  
**Washington DC 20009**  
**(202) 667-3574**

## TI-Forth Utilities

# Helpful, useful and well done

By HOWARD H. ARNOLD

A large segment of the TI community indeed has tried TI-Forth. Many of us have become addicted and believe there is probably *no other* language—surely none better.

But many others have loaded the system disk, acquired from their user's group or from MICROpendium, and found learning so difficult that they have shortly abandoned the venture.

Here's help.

Mike DeFrank offers a package called TI Forth Utilities. At \$19.95 it is priced just above the range of free-ware. It comes with a nicely organized 15-page manual and two SS/SD disks. You can access the programs either through Editor/Assembler or through SUPERCART (described in June-July 1985 MICROpendium). I don't have a SUPERCART cartridge, so was able to test only the E/A version. Disk 1 contains the enhanced Forth system, loaded through Option 3 of the Editor/Assembler with the file name DSK1.FORTH. Disk 2, in addition to the SUPERCART version of the Forth system, contains speech, sound and floating point utilities.

The first thing you'll notice after loading the system is a neat TI Forth logo and a menu of load options, much shorter than the menu offered by the TI-Forth disk. This is because most of the options listed on the TI-Forth screen have already been loaded at startup! No more will you get that silly "?" when you type "n EDIT" only to find the editor hasn't been loaded. DeFrank has opted to load CODE, SYNONYMS, COPY, DUMP, TEXT, GRAPH1, GRAPH 2, GRAPH, FILE and BSAVE from a binary file immediately after booting the system. He has also provided a slightly modified version of PRINT and a much improved EDITOR, along with a number of "Misc. Words" (more later on these). In addition to the convenience of having these files already available, this method of loading them is much faster

## Review

### Report Card

Performance .....	A+
Ease of Use.....	A+
Documentation .....	B
Value.....	A
Final Grade.....	A

Cost: \$19.95

Manufacturer: Mike DeFrank, 4374 NW 9th Ave., Pompano Beach FL 33064

Requirements: Editor/Assembler, 32K, disk drive

than loading from the screens. One example: it takes just three seconds to load the editor this way!

The default editor, loaded at power-up, is the 64-column version. This, like its TI ancestor, uses tiny characters so that a full Forth screen fits on the monitor. My color monitor isn't clean enough to prevent color smearing of

these little characters, so it's almost impossible to read them. On page 2 of the manual, however, DeFrank gives us clear and explicit instructions on how to change this and other defaults. You may also need to change the expected number of drives in the system at this time. The manual indicates this default is "1" but the disk I received had a value of "2"—which happened to be right, in my case. (This is the only error of any kind I found in the manual. I did find the printing—photo-reduced dot matrix print, I believe—to be quite illegible in a few places. K, for example, often came out looking like a slightly smeared I. I actually had to list Screen 43 to find out what the word KILL was.)

You can also change the screen color at this juncture if that kind of option turns you on. I'm personally quite well satisfied with the white on blue default provided.

The editor, whether you choose the 64-column or 40-column version, has

(Please turn to Page 37)

T I F O R T H

F O R T H U T I L I T I E S I

Version 2.1 (C) 1986 by Mike De Frank

[64 Column Editor Loaded] 5102 Bytes

-DECOMPILER	-EDITOR64	-FLOAT2
-SCR/DUMP	-EDITOR40	-CRU
-DISASSEMBLER	-SOUND	-TRACE
-DECOMPILER2	-SPEECH	-ASSEMBLER

TI FORTH  
-SCR/DUMP

Insure UTIL1 Disk is in Drive 1  
then Press any Key to Continue.

Screen Dump Loaded. ok  
2 SDUMP

## TI FORTH UTILITIES—

(Continued from Page 37)

been much improved over its TI parent. Several of the editing keys have been reassigned to make more sense. For example, CLEAR now is used to escape from the editor instead of BACK, previously used. BACK now, with indisputable logic, moves you back one screen while in editing mode. PROC'd moves forward one screen. You may now even be able to remember most of the key assignments; but there's no real need, since CTRL 9 (always listed on the editing screen) provides a two-page HELP manual whenever you need to be reminded.

Some other helpful additions are a word tab feature, which moves the cursor to the next (or previous) Forth word on the screen and a reminder when leaving editor mode of which screens have been updated so you can be sure to FLUSH them if you wish. By the way, DeFrank has renamed FLUSH to SAVE—much more descriptive, and he says he "couldn't bear FLUSH." Other word changes include BYE for MON, GO for GOTOXY and KILL for EMPTY-BUFFERS. The old words still work too, however, so if you have them permanently emblazoned on your memory, no problem. There are a couple dozen more of these "Misc. Words" ranging from trivial renaming of existing functions to downright useful additions.

Powerful sound and speech capability is also provided by the TI-Forth Utilities package. And demonstrations of these, along with the source code used to generate the demos, are included. There are also some graphics and color demos with their source code. And a modest "windowing" capability is provided in bitmap mode.

One very useful feature is provided via SDUMP. This utility permits the monitor screen to be copied to an Epson compatible printer, either in single or double size. It came as quite a surprise to me when the copies came out with the top of the screen on my right rather than at the top of the paper.

This way, a full 8½-by-11-inch page is neatly filled by a double-size screen image. This works in either text or graphics mode, opening up a whole range of possibilities, either within programs or as a means of storing information in the program generation process.

For the beginner, if nothing else were included in the package, these enhanced capabilities and user-friendliness would be a real bargain. But for somewhat more advanced programmers, some features are provided that are truly outstanding. Two decompilers are included. One of these permits entry of any Forth word in the form:

' WORD TR

and a complete listing of the word's definition is displayed on the screen, together with pertinent addresses. A companion capability, using the word TR2, permits decompilation AND disassembly of words containing machine code. And, finally, a disassembler is provided for disassembling machine code, given only the starting and stopping addresses. None of these utilities offers the option of dumping the disassembly to disk or printer, so they will necessarily be limited to use on rather short definitions or programs during manual debugging sessions, or to an examination of some foreign Forth program for which you don't have the source code.

Another feature, most likely to be of value to the more advanced user, is the inclusion of an enhanced floating point package. Many of the floating point routines have been rewritten in assembly code, so a considerable improvement in speed can be obtained. I made no attempt to benchmark these routines against the standard package, but I did try a 1000-calculation loop, entering and multiplying two floating point numbers. I found that the DeFrank package accomplished the loop in 14 seconds as compared to 19 seconds for the old version. In case you're about to abandon integer arithmetic for floating point, though,

be advised that a similar loop for integers comes in at well under one second!

Still another enhancement provided will be of help to all categories of user. This is an improved and enlarged character set. Besides the lowercase characters already commonly available in other packages, several line graphics symbols have been added, to permit the professional-looking screens seen in some of the menus in this package and in the 40-column editor.

Perhaps I've had too much to say *about* TI Forth Utilities; if so, this is because it's almost impossible to say too much *for* this package. It provides a long-needed assist to both the beginner and the experienced user of Forth.

I find one aspect of the package of some concern, however. The enhancements are so useful that they should be included in the programs generated by every Forth program developer. The copyright notices would seem to imply that copying this material is forbidden, however. It would seem quite ridiculous to develop programs using the DeFrank floating point arithmetic, for example, and then have to revise them with the old-fashioned version before distributing to others. It appears I won't be able to make use of most of the material myself, therefore, since I intend to distribute my product to others as freeware or otherwise. This is a matter not peculiar to this package, but a real dilemma in the software community.

In any case, I highly recommend TI Forth Utilities for beginners and experienced users alike if their programming activities are confined to their own personal use.

### Users seek input

L.I. Stevens of New Zealand writes that he and several TI99/4A users have a "loose" association and would welcome receiving mail from suppliers of TI products with "any updates etc."

For further information, contact Stevens at 92, Station Rd., Papatoetoe, Auckland, New Zealand.

## CorComp Memory Plus

# Manager is only shortcoming

By SCOTT DARLING

The CorComp Memory Plus card comes in four variations: 256K and 512K cards for the Peripheral Expansion Box, and 256K and 512K standalone units (SAU). (I used the 512K card for this review.) Two SAUs or one SAU and one P-Box card may be configured together. Two PEB cards won't work. The following cards were in use in my PEB while reviewing Memory Plus: Triple Tech, RS232, CorComp disk controller and Horizon 192K RAMdisk. Also, I used Miller Graphics' GRAM Kracker without any problems.

The Memory Plus card requires that the original 32K card be removed. The SAU operates with or without the 32K card. A 9-volt power supply is included for backing up the card or SAU memory. It should not be the sole source of a copy of the Memory Plus.

All units will operate at address >1000 or >1400. These are the only choices for addresses. At >1000 the unit may be named drive No. 1 through 5, or R. At >1400 the only choice is No. 6.

**Performance:** The card does everything the documentation says it is supposed to do. The power supply backup never crashed. I wrote 120 plus files on the card and used them every day. I was able to move and manipulate them successfully every time. Apparently, there were some glitches in the earlier cards. This problem seems to have been taken care of. The version of the PROM in this card is 2.42.

Under certain circumstances, the only disk manager that can be used is resident on the card. The command to access it from BASIC or Extended BASIC is CALL RMGR. This manager is the only sore point I have with the card. It has several drawbacks.

This manager is required for any memory configuration above 400 kilobytes. (This shouldn't be a problem

## Review

**Report Card**

**Performance**.....B  
**Ease of Use**.....A  
**Documentation**.....A  
**Value**.....B  
**Final Grade**.....B

**Cost:** \$190-\$280 depending on version

**Manufacturer:** CorComp Inc., 2211-G East Winston Rd., Anaheim, Ca. 92807 (714) 630-2903

**Requirements:** Console, disk system (available as standalone or PEB card)

for anyone using a Memory Plus with 512K of memory initialized as the equivalent of a DS/DD (1440-sector) diskette.

The reason this manager has to be used is that the card uses three sectors for information about the disk. Sector 0 is used for the disk name, sector 1 is reserved for the file directory, and sector 2 is reserved for the disk bit map. (Sector 0 is not large enough by itself to handle the card's expansion potential of 2048 sectors.)

While you may read a RAMdisk directory with any other manager, don't attempt to write to it using another disk manager if the card is expanded beyond 512K. However, the resident manager can access floppy disk drives as well as the RAMdisk and works well with the existing disk controller.

The resident manager is only 8K long, and I feel it doesn't measure up to recent developments in disk manager software. Although it functions flawlessly, it isn't as well designed as others. For example, with single files the user has to provide the name of a file on which to perform such activities as renaming, deleting, changing file protection or copying.

However, there are provisions for

disk image and multiple file copying. Using multiple file copy, you are asked if you want to copy all files. If you answer "no," it reads the directory and prompts "Copy Y/N." It does this for each file heading, then goes back and does the actual copying. On screen is a reminder about which drive the card is accessing. You may also change the drive number using the manager or use a DELETE "SD.x", where x is the drive number.

The manager also has a RAMdisk test built into it, though it doesn't seem to work properly at address 1400. However, it functions properly at address >1000. Also, the R command doesn't work at >1400 because, if there were two cards available, the system wouldn't know which one to go after.

There is another resident function on the card—DELETE "LOWER". This provides a lowercase character set with descenders for use with a running BASIC or Extended BASIC program. You return to the original character set when in command mode.

Aside from my reservations regarding the disk manager, I also found that the CALL CAT("DSK3.") from GRAM Kracker doesn't function. CorComp plans to rectify this. Obviously, this would be of concern only to someone with GRAM Kracker.

Positive points include a resident manager that can access any drive, floppy or Ramdisk; and 480 kilobytes of RAMdisk memory. This is 80K more memory than is provided by the Myarc RAMdisk, the ballpark equivalent of a single-sided, single-density floppy.

Another noteworthy item is a switch with built-in remote pins that sort of write-protects the card before powering down. This is supposed to eliminate any power feedback glitches. To quote CorComp, its purpose is analogous to "opening the disk drive doors." I

(Please turn to Page 40)

# Newsbytes

## Trinity Systems sells speech processor

Trinity Systems of Pittsburgh, Pennsylvania, has released Yak-Man, a menu-driven speech processor.

According to David Butalla of Trinity Systems, Yak-Man says "anything you want, forwards, backwards, even in Pig Latin."

Yak-Man also spells, he says. The software is programmed to recite some Shakespeare and the entire Lord's Prayer as well as a "Yak Rap" and a computer jargon alphabet.

Users have a choice of 64 different voices for Yak-Man, according to the manufacturer.

The manufacturer says Yak-Man has

four sound F-X functions and a speech database that allows the user to create and edit about 500 words of speech text. Yak-Man comes with documentation that can be read into the speech file and accessed online, Butalla says.

Yak-Man is available on tape for \$14.95. The program requires a Speech Synthesizer and Terminal Emulator II. The manufacturer offers a Yak-Man demo tape for \$5.95, \$5 of which is refundable upon the purchase of Yak-Man.

For further information, contact Trinity Systems, 1022 Grandview Ave., Pittsburgh, PA 15237 or (412) 373-8782.

## DOS reduces risk for buyers

Disk Only Software president Jeff Guide has announced an innovative marketing agreement with Horizon Computer Ltd. on the distribution of the Horizon RAM Disk Card (reviewed in July 1986 MICROpendium). A RAM disk is a device that emulates a floppy disk.

According to Guide, "No longer will you have to pay the full cost of a RAM disk kit in order to see if you really are able to build one." A number of programs are also included in the package, Guide said.

Guide says that users may purchase a step-by-step construction guide by Ron Gries for \$4. "After you have studied the guide, you can order the rest," he said. Users may then purchase a users manual by D.R. Romer for \$6 and a collection of user hints and ideas for \$2. The board costs \$53 (parts are extra. Cost of the parts have yet to be determined). Assembled versions are available for \$165, single-sided, and \$210, double-sided.

Guide says, "up until the time you actually start building the card, you may obtain a full merchandise credit by returning to us the documentation in sellable condition."

DOS has also announced the publishing of its fall-winter TI99/4A product catalog. To obtain a copy, call 1-800-446-4462 + 897335 at the tone or 301-369-1339 or write Disk Only Software, P.O. Box 244, Lorton, Virginia 22079. To order products, use the same telephone numbers and have credit card information ready, or order direct from DOS at P.O. Box 4170, Rockville, MD 20850.

## Texaments releases Rapid Copy utility

Rapid Copy, described as "the only turbo copier specifically designed to take full advantage of the Myarc, CorComp and Texas Instruments disk con-

(Please turn to Page 41)

## MEMORY PLUS—

(Continued from Page 39)

found that if I did this I did not lose any data. But when I didn't I would sometimes lose a byte or two in the files. And they would act very strangely. So I got into a habit of using this switch.

A big advantage of this card is its ability to work with the other RAM-disk cards, though I found that the Horizon RAMdisk seemed to have the most trouble. I placed it at address >1000 and the CorComp Memory Plus at >1400. Everything powered-up and ran fine. When I reversed the cards' addresses the system refused to power up. I finally set the Horizon at >1700. The system powered up, but I could not access the Horizon. I plan to explore this more.

Also, CorComp has promised several programs—including a word processor, spreadsheet and database—designed specifically for use with the Memory Plus. They are not ready for release, though the word processor is supposed to be available soon. CorComp notes that an improved resident manager is going to be available.

**Ease of Use:** The card is very simple to install and operate. There are only

two major decisions to be made before operating the card: Which address to use and which drive number to assign it. After the card or SAU is installed it is treated exactly like a disk drive.

**Documentation:** The documentation is actually overdone. Besides describing the installation procedure, it includes a detailed section on how to read and write files. This is one subject that most users will not need any advice on. The manual also fully explains the manager functions.

**Value:** It is hard to place a value on a RAMdisk, as each brand has its own strengths and weaknesses. CorComp's Memory Plus is well-suited for programs that do a lot of disk-accessing—databases, bulletin boards, spreadsheets, GRAM Kracker files, Editor/Assembler and TI-Writer. Rapid assembling of assembly language programs, as well as downloading from bulletin boards and electronic information services are some of many applications for this card. And there is a roundabout way of print spooling by writing the file to the RAMdisk and then printing it from the RAMdisk later.

# Newsbytes

(Continued from Page 40)

troller cards," has been released by Texaments.

According to Steve Lamberti of Texaments, the program is fully menu driven and allows a multitude of copy and format options. Depending on system configuration, copy times range from 35 seconds for a single-sided single-density disk to one minute, 17 seconds for a double-sided double-density disk, he says. He says that on average Rapid Copy is six times faster than the disk copy functions of the Myarc, CorComp and DM1000 disk managers.

Rapid Copy is endorsed by Myarc Inc., Lamberti says, and a new modified version of their disk management software is included with the program which allows the user from within its utility option. Lamberti also says that with Rapid Copy, CorComp and TI disk controller owners have the option to format disks using different interlaces.

Rapid copy is available for \$14.95 plus \$1.50 shipping. System requirements are 32K memory expansion, disk drive system consisting of at least one floppy disk drive and either the Extended BASIC, Editor/Assembler or TI-Writer command module.

For further information, contact Texaments, 53 Center St., Patchogue, NY 11772 or (516)475-3480.

## Ryte Data offers 'run time' GPL Linker

Ryte Data announces the release of a "run-time" version of GPL Linker by Monty Schmidt.

GPL Linker is designed to make graphics programming language programs available with 32K and a disk drive by creating program image files from GPL object codes. These files can then be using Option 5 Run Program File of the Editor/Assembler module.

The Linker sets up the upper 24K of expansion memory as blocks of GRAM (Graphics Ram) for use in GPL programs. These blocks can be

specified when writing GPL routines for assembly. Linker then sets up a simulator within the 8K low memory to execute compressed or uncompressed object code generated by the GPL Assembler.

According to Bruce Ryan of Ryte Data, the Run Time Linker package is designed to allow TI owners to run new GPL programs currently available and demonstrate "the ease of programming allowed using the GPL Assembler."

The package includes an Extended BASIC loader, four demonstration files and the new "Convert" program by Heiner Martin. This program, Ryan says, converts TI BASIC to Microsoft BASIC or Mechatronic XBIIplus. He says Convert will also work to convert Microsoft BASIC to TI BASIC syntax automatically under program control.

Ryan says that Martin has placed Convert in the public domain and that Ryte Data is sending it free with RT Linker. Source files and documentation are on disk.

RT Linker is available for \$10 plus \$2 shipping from Ryte Data, 210 Mountain St. Haliburton, Ontario, Canada K0M 1S0.

Ryan notes that additional documentation for the GPL Assembler is now included with each package sold. The documentation includes more information on the FMT command and updates on information contained in the book *Intern*.

He says that Ryte Data is also taking orders for Mechatronics' 80-Column Display Unit.

For further information, contact Ryte Data at (705) 457-2774.

## Thomson Software products available

Support is still available for programs which were published and marketed by Thomson Software (M & T Utilityware)

C. Case of Huntsville, Alabama, has purchased the rights to DISK + AID,

MEMORY MANIPULATOR and CREDIT CARD DATABASE and says he will provide support for all holders of singular-purchase original programs, including update support for the new version of DISK + AID.

He says the new version of DISK + AID includes support for RAMdisk and five drives (six available on request). Price is \$20 new or \$5 upgrade from earlier versions of DISK + AID. All three are available for the package of \$30 (\$15 for an upgrade of DISK + AID and a new MEMORY MANIPULATOR AND CREDIT CARD DATABASE).

For further information or to order, contact Case at P.O. Box 14130, Huntsville, AL 35815 or (205) 883-8348.

## Hardware available from California firm

Hardware designed for use with the TI99/4A is available from All Electronics Corp. of Los Angeles, California.

Products available include a combination power supply and transformer, 48 key unencoded keyboard assembly, connectors, a sound and video modulator, a serial RS-232 Y cable, a dual cassette/computer cable, miniature toggle switches, ribbon cables, potentiometers and cooling fans.

For further information, contact All Electronics Corp., P.O. Box 20406, Los Angeles, CA 90006 or (213) 380-8000.

## Asgard issues c99 programs

Asgard Software is scheduling the release of two programs written using c99. c99 is a language that was developed by Clint Pulley for the TI. The programs are High Gravity and Total Filer. High Gravity is priced at \$14.95 and Total Filer is \$24.95. The release date is Oct. 27.

High Gravity, by Tom Wible (a professional programmer with TRW),  
(Please turn to Page 42)

# User Notes

(Continued from Page 41)

puts you in command of a relief spacecraft sent to aid a space station trapped in a strange solar system. The planets in the system are thick as flies, and prevent anyone from leaving or entering the solar system to rescue the unfortunates in the space station. Your mission is to shoot a capsule of supplies to the stranded astronauts, and you only have ten capsules of supplies on hand. Worse yet, you can't guide the capsules through since they have no engines.

Asgard says the programs strengths are in its graphics and playability and in the accuracy of its simulation of the laws of gravity and motion of projectiles. It requires the Editor/Assembler module, 32K and a disk system.

Asgard describes Total Filer, by Warren Agee, as "the first and only database designed for text." The program is designed to keep track of files created with TI-Writer.

With Total Filer users can create a file-by-file index of all text files. The index can include multiple keyword references for quick searches, as well as several layers of description for each. Total Filer allows full wildcard capability, which means users may search for any string of characters or any combination of letters within user-specified limits. Total Filer includes utilities for creating a master listing of the index and for compressing the index to save space on index disks.

Total Filer requires Editor/Assembler, 32K and a disk system.

For more information or to order, contact Asgard Software at P.O. Box 10306, Rockville, MD 20850, (301) 345-2492.

## MG to offer GK enhancements

Millers Graphics, 1475 W. Cypress Ave., San Dimas, CA 91773 (714-599-1431), is in the process of releasing an enhancement disk for use with its GRAM Kracker and a replace-

ment PROM for use with CorComp's disk controller.

The enhancement disk will support a number of operations in Extended BASIC. Among them are the ability to list programs with user-defined line length, resequencing of all or part of a program and the output of the TRACE command to a designated device. Also supported will be the ability to copy, move or delete blocks of program lines.

New CALLs will include EA (to move directly to the Editor/Assembler; CALL PEEKG to peek GRAM and GROM addresses; CALL PEEKV to peek VDP memory; CALL POKEG to poke GRAM address; and CALL POKEV to poke VDP memory.

Other enhancements include additional support for Editor/Assembler, including repeating keys, erase key and formatting of a Myarc RAMdisk.

The price of \$10 includes documentation and shipping.

The Millers Graphics PROM for the CorComp disk controller will support a wildcard disk drive designation using an asterisk as the operator. After a drive has been designated, the asterisk will continue to access it as a default drive number. The wildcard feature will operate out of TI-Writer, BASIC, Extended BASIC, Editor/Assembler, Multiplan and other software.

The PROM also will allow users to access the CorComp disk manager from BASIC. Several new CALLs are also supported. These include CALL LLR to link, load and run; CALL ILR to initialize, load and run; CALL LR to load and run; CALL RUN to run a program.

Price and availability of the PROM have yet to be determined. Contact Millers Graphics for more information.

## After Hours BBS for sale at discount

The After Hours Bulletin Board System, written in 100 percent assembly language and described by the manufacturer as the fastest bulletin board

operating on any home computer, is available commercially.

Ed Schaum, of the Bronx, New York, says he is selling the final version for \$100. Advance copies are available for \$50 (customized), including free "lifetime updates," Schaum says.

Schaum says he sent information to MICROpendium in response to the letter by Herman Mosakowski in the August issue, and is offering a discounted price of \$25 to MICROpendium readers, which includes the lifetime updates.

Schaum says the BBS requires the user to load one file, and the program is in operation. He says, "It does not require the use of multiple diskettes or drives and requires no preliminary set-up whatsoever."

He says the system uses the standard cable to connect the RS232 to the modem, with no special cables needed.

The board features including a user voting section, 14 independent message bases (expandable to as many as the user's disk controller can handle), recent caller list, chat mode, 300/1200 baud, multiple newsletters, automatic word wrap, split screen for sysop-important information on the current user on screen at all times while text rolls by, 40 column screen and instant sysop override of any user function, according to Schaum.

He says that Xmodem file transfer routines are included in the code but are currently inoperational "until the final bugs are worked out."

Requirements are a Hayes compatible modem, memory expansion, any brand of RS232 card, standard modem cable, the Editor/Assembler cartridge (or any other control program—e.g., Myarc's Disk Manager—providing a "Load and Run" option) and a telephone line.

He says, "To see the system in operation, call (212) 547-4210. If you would like more information about the system, feel free to yell for me when you call."

The system may be ordered from Ed Schaum, 1060 Arnov Ave., Bronx, NY 10469.

# User Notes

## Vary the length of program listings

Eugene VandenBoss, of Adrian, Michigan, provided the following program, which allows the user to determine the line length of program listings. The program is called LISTINGVAR.

To use LISTINGVAR, it is necessary to save the program you wish to list via LIST "DSKn.FILENAME". This creates a D/V 80 file that is read by LISTINGVAR. When LISTINGVAR is run, the user is prompted for a printer name (the default is PIO) and the disk drive number and filename of the LISTed program to be listed. The user then enters the line length (between 10 and 136) and the program does the rest.

The program listing below was done using LISTINGVAR.

Users may need to modify line 170, depending on the type of printer in use. As published, the program is designed

for a Delta Star. For a Gemini printer, replace CHR\$(15) in line 170 with CHR\$(27);CHR\$(66);CHR\$(3). Also, replace CHR\$(18) with CHR\$(27);CHR\$(66);CHR\$(1) or (2), depending on whether you wish to use 10- or 12-characters per inch. (The printer name default may also be modified in line 120. Changes will also be required in lines 170 and 280.)

VandenBoss writes that he developed LISTINGVAR to solve a problem that occurred when using XLATE, which was published in a previous edition of MICROpendium.

The problem "is that of having the program decide when it is a new line or an extension of an old line. I tried several years ago to write such and gave up. The mistake I was making then was that I was looking at it as a prefix problem, which had only a few hundred cases. (Then) I came up with the thought that it might be a postfix problem. I still have not solved the problem, but this is much closer. LISTINGVAR will still fail if an extended line ends in the form: *number !*

*stuff*. But this type of form is not that common and could be replaced by: *number :: ! stuff*. I will not say that I have found all the postfixes, but LISTINGVAR works on all that I have tried it on."

```

100 !LISTINGVAR
110 DISPLAY AT(1,6)ERASE ALL
: "OUTPUTS LISTINGS WITH LENG
TH": : " BETWEEN 10 AND 1
36"
120 DISPLAY AT(11,1): "PRINTE
R PIO"
130 ACCEPT AT(11,9)SIZE(-28)
: P$ :: DISPLAY AT(13,1): "DIS
K FILENAME DSK1.LIST" :: ACC
EPT AT(13,15)SIZE(-14): D$
140 DISPLAY AT(15,1): "WIDTH
10 TO 136 028" :: ACCEPT AT(
15,17)SIZE(-3): L
150 IF L>9 AND L<137 THEN 16
0 ELSE 140
160 OPEN #1:P$, VARIABLE L ::
OPEN #2:D$, INPUT , DISPLAY ,
VARIABLE 80
170 IF P$="PIO" THEN IF L>80
THEN PRINT #1:CHR$(15)ELSE
PRINT #1:CHR$(18)
180 LINPUT #2:B$ :: A$=B$ ::
IF EOF(2)THEN 280
190 LINPUT #2:B$ :: P1=POS(B
$, " ", 1):: IF P1<2 THEN 270
200 ON ERROR 300 :: V1=VAL(S
EG$(B$, 1, P1))
210 IF SEG$(B$, P1+1, 1)=" " T
HEN P1=P1+1 :: GOTO 210 ELSE
P1=P1+1
220 IF P1>=LEN(B$)THEN 270
230 V1$=SEG$(B$, P1, 4):: IF V
1$="THEN" OR V1$="ELSE" THEN
270 ELSE V1$=SEG$(B$, P1, 3):
: IF V1$="AND" THEN 270
240 V1$=SEG$(B$, P1, 2):: IF V
1$=":" OR V1$="OR" OR V1$="
**" THEN 270
250 V1$=SEG$(B$, P1, 1):: IF V
1$="+" OR V1$="*" OR V1$="^"
OR V1$="-" OR V1$="/" OR V1
$=")" OR V1$="<" OR V1$=">"
OR V1$="=" THEN 270
260 PRINT #1:A$ :: A$=B$ ::
IF EOF(2)THEN 280 ELSE 190
270 A$=A$&B$ :: IF EOF(2)THE
N 280 ELSE 190

```

(Please turn to Page 44)

## Night Mission score feature

The following comes from Kazco International, P.O. Box 44023, Sylmar, CA 91342:

Those of us smart enough to be owners of Miller Graphics' Night Mission already know it is educational, as well as entertaining. Its documentation alone is well worth the price. With this in mind, Kazco International in no way presumes our change is an improvement, but rather an addition. Even so, once you've keyed in this high score feature, we think you'll agree that it looks, sounds and acts as if it belongs there.

You must first change three existing lines in the game programs called NMJOY and NMKEY but make no changes to LOAD. Here are the lines, including changes:

```

10 CALL MAGNIFY(3):: CALL SCREEN(2):: GOTO 30 :: CALL KEY :: CALL JOYST :: CALL
SOUND :: CALL PEEK :: CALL HCHAR :: CALL VCHAR :: HS :: MAX
220 CALL COLOR(10,1,1):: DISPLAY AT(7,16): "" :: CALL CHAR(108, E$&"55000061E1FFFF
FF0000003"&E$&"5540E0F8E4E2E1F1FF7C45FE")
260 IF Z THEN B=B+Z*10000 :: GOTO 740 ELSE CALL CHAR(108, "FFB1BFA0AFB981FFFFB1E7
1818E781FFE78585BDBDADADE7E7A5A5BDA5A5A5E7")

```

Next, you must add three entirely new lines to NMJOY and NMKEY:

```

272 DISPLAY AT(7,7): "o m l o" :: HS=MAX(HS, SC):: IF SC<HS THEN 278 ELSE CALL COL
OR(10,6,1):: DISPLAY AT(7,16): HS
274 FOR X=0 TO 27 STEP 3 :: CALL SOUND(-155,550,X,557,X):: DISPLAY AT(7,7): "" ::
DISPLAY AT(7,7): "o m l o " &STR$(HS):: CALL SOUND(-1,4E4,30):: NEXT X
278 CALL COLOR(10,6,1):: DISPLAY AT(7,16): HS

```

That's all there is to it. Remember to SAVE your altered program to a new disk (include LOAD) rather than to your original game disk. Kazco welcomes any comments on this change. Mail comments to the above address.

# User Notes

(Continued from Page 43)

```
280 PRINT #1:A$ :: IF P$="PI
Q" THEN PRINT #1:CHR$(18)
290 CLOSE #1 :: CLOSE #2 ::
STOP
300 RETURN 270
310 END
```

## Faking-out the formatter

Ralph J. Mineo, of Lakeside, Ohio, writes: "Want to fake out your TI-Writer formatter so that you don't have to reload it—and you won't have to write a separate file with .IF (Include File) commands? You can do it with only one line (and this comes in handy when you're dealing with a full disk and don't want to use two sectors for an .IF file.) Make the last line of

your program: ".IF FAKEOUT!" Even if you have a file with that name, the formatter will "crash" and you can enter a new file without having to reload the formatter (since you "forgot" to put in "DSKn." before the file name. Maybe use the New Page command with it to get your second file on a clean page."

## I/O buffer works for you

There's more than one way to send data to a printer, and some are faster than others. Jim Swedlow, of the Users Group of Orange County, Fountain Valley, California, published the following in the groups newsletter, ROM.

When you send data to your printer

or to disk, your TI stores information in the input-output buffer. Generally, it will keep data until it sees the end of a record.

To illustrate, consider this program. It demonstrates the graphics abilities of Epson and compatible printers.

```
10 OPEN #1:"PIO.CR"
20 PRINT #1:CHR$(27);"L";CHR
$(127);CHR$(0)
30 FOR I=1 TO 127
40 PRINT #1:CHR$(I)
50 NEXT I
60 PRINT #1:CHR$(13)
70 CLOSE #1
```

Line 10 opens your printer and tells you 4A not to send a carriage return and a linefeed every 80 characters. Line 20 puts your printer in graphics mode and tells it it expect 127 graphics characters. The loop in lines 30 through 50 send the entire range of graphics characters. Line 60 sends a carriage return to clear the printer's buffer.

Since there is no print separator after the CHR\$(I) in line 40, each character is taken as a record and sent to the printer. If you added a semicolon after the CHR\$(I), all 127 graphics codes would be held in the input-output buffer until line 60 is executed.

The difference is speed. Without the semicolon, it took about 10.2 seconds for this program to run. When the print separator is added, run-time dropped to 7.5 seconds.

## DM1000 too fast?

Version 3.1 of Disk Manager 1000 is a nifty program, but Louis Guion of the NET 99ers says it can be made even better by making a small modification. A problem he encountered is that when he holds a key down for a brief time it repeats several times. His suggestion is to slow down the repeat action.

First, copy the MGR1 file to a newly initialized disk. Then load a sector access program and go to sector 36 or have the program search for the following hex string:

(Please turn to Page 45)

## Wordcount revised

Bob Mack, of Waynesboro, Georgia, submitted the following revision of the Wordcount program written by B. Davies. Wordcount was published in the April 1986 issue of MICROpendium. The program counts words in TI-Writer files.

This revision condenses the code and offers a fast and slow speed. The slow mode displays the line number, line text and a running word count at the bottom of the screen. The fast mode operates like the original, with the total appearing after the entire file has been processed.

```
100 ! WORDCOUNT BY B. DAVIES      (REVISED BY BOB MACK      7/22/86)
110 DIM B$(20)
120 E$=".IN.LM.BP.SP.TL.FI.FO.HE.IF.CE.AD.LS.ML.NA.NF.PA.PL.RM.CO.DP" :: FOR I=1
TO 60 STEP 3 :: B$((I+2)/3)=SEG$(E$,I,3):: NEXT I :: E$=RPT$(" ",104)
130 W=0 :: DISPLAY AT(1,10)ERASE ALL:"WORDCOUNT" :: DISPLAY AT(5,2):"SELECT: 1
FAST MODE": " 2 SLOW MODE" :: ACCEPT AT(5,27)BEEP VALIDATE("12"):A$ :: I
F A$="1" THEN F=1 ELSE F=0
140 DISPLAY AT(5,1):E$ :: DISPLAY AT(5,2):"Enter Text File Name" :: DISPLAY AT(7
,7):"DSK" :: ACCEPT AT(7,10)SIZE(12):D$
150 ON ERROR 290
160 L=0 :: DISPLAY AT(12,1):"FILE INPUT IN PROGRESS..." :: IF F=0 THEN DISPLAY A
T(14,1):" Line Number:"
170 OPEN #1:"DSK"&D$,INPUT
180 LINUT #1:A$ :: L=L+1 :: DISPLAY AT(14,19):E$ :: IF F=1 THEN 190 ELSE DISPLA
Y AT(14,18):L :: DISPLAY AT(15,1):E$ :: DISPLAY AT(15,1):A$
190 IF EOF(1)=1 THEN 270
200 IF A$="" THEN 180 :: Q=ASC(SEG$(A$,1,1)):: IF Q=27 OR Q=46 THEN 180 :: IF Q<
32 OR Q>126 THEN A$=SEG$(A$,2,LEN(A$)-1):: GOTO 190
210 FOR I=1 TO 20 :: IF POS(A$,B$(I),1)=1 THEN 180
220 NEXT I
230 FOR I=1 TO LEN(A$):: C=ASC(SEG$(A$,I,1)):: A=((C>64)*(C<91))+((C>96)*(C<123)
)+(C>47)*(C<58))+C<39):: IF A=0 THEN 240 ELSE D=1 :: GOTO 250
240 IF D=0 THEN 250 ELSE W=W+1 :: D=0 :: IF F=1 THEN 250 ELSE GOSUB 300
250 NEXT I :: D=0 :: IF A=1 THEN 260 ELSE GOTO 180
260 W=W+1 :: IF F=1 THEN 180 ELSE GOSUB 300 :: GOTO 180
270 CLOSE #1 :: DISPLAY AT(19,1)BEEP:"There are about" :: DISPLAY AT(19,17):W ::
DISPLAY AT(19,23):"words" :: DISPLAY AT(20,1):"in the Text File entered."
280 DISPLAY AT(22,1):"Another Text File? (Y/N)" :: ACCEPT AT(22,26)SIZE(1)VALIDA
TE("YN"):A$ :: IF A$="Y" THEN 130 ELSE STOP
290 CALL SCREEN(7):: DISPLAY AT(23,1)BEEP ERASE ALL:"DRIVE/FILE NAME ERROR" :: F
OR I=1 TO 500 :: NEXT I :: CALL SCREEN(8):: RETURN 140
300 DISPLAY AT(23,12):W :: RETURN
```

# User Notes

(Continued from Page 44)

```
06 03 16 F9 03 80 00 A0 FF 00 C0 1D
```

The important bytes are 42 and 43, the 00A0 in the above string. Changing these bytes will modify the speed of the repeat action. The range of acceptable values falls between 00A0 and 07D0.

After making the change, save it and then copy the modified MGR1 file to your working copy of DM1000.

## Keeping track of disk contents

This isn't a very elegant way of producing a master catalog of the programs on your diskettes, but it's cheap and easy and a good place to start, particularly if you have TI-Writer. The program runs in BASIC or Extended BASIC. There are features one can add with little trouble that could result in a very nice and cost-free way of maintaining your library of files and programs.

The whole idea of this program is to produce a disk catalog that is written to disk and that can be loaded into TI-Writer. With TI-Writer, the user should be able to load numerous disk

catalogs into memory, save them and perhaps sort them using one of the various sort routines that are available. Outputting the finished product to a printer would provide an up-to-date catalog of one's program library. One may also find a way to use the outputted catalog files to be read by database program. TI-Writer can even be used for this purpose. The user simply enters the name of the program he is seeking using the Find String function.

We started with the disk catalog program from the manual that came with the TI disk controller. With slight modifications to a couple of lines (230, 240, 280, 310 and 340) and the addition of three new lines (212, 215 and 345) we set it up so that it would print the catalog to a disk drive and disk file named by the user. At this point, it can be used only by a user with at least two drives (a RAMdisk could possibly be used, also). The problem with a one drive setup is that it the program cannot write a catalog of a disk that is concurrently being read from and written to.

Here is what the program line additions do:

```
1 CALL CLEAR
40 REM FROM PAGE 43 OF DISC MEMORY MANUAL
110 DIM TYPES$(5)
120 TYPE$(1)="DIS/FIX"
130 TYPE$(2)="DIS/VAR"
140 TYPE$(3)="INT/FIX"
150 TYPE$(4)="INT/VAR"
160 TYPE$(5)="PROGRAM"
170 INPUT "MASTER DISK(1-3)? ":A
180 A=INT(A)
190 IF A<1 THEN 170
200 IF A>3 THEN 170
210 OPEN #1:"DSK"&STR$(A)&".",INPUT,RELATIVE,INTERNAL
212 INPUT "Enter Drive No.and Filename for catalog: ":DN$
215 OPEN #2:DN$,OUTPUT,RELATIVE
220 INPUT #1:A$,J,J,K
230 PRINT #2:"DISK FILE CATALOG";"DSK.;" - DISKNAME=" ;A$;"AVAILABLE=" ;K;" USED
=" ;J-K
240 PRINT #2:"FILENAME SIZE TYPE P";"-----"
250 FOR LOOP=1 TO 127
260 INPUT #1:A$,A,J,K
270 IF LEN(A$)=0 THEN 350
280 PRINT #2:TAB(1);A$;TAB(12);J;TAB(17);TYPE$(ABS(A));
290 IF ABS(A)=5 THEN 320
300 B$=" "&STR$(K)
310 PRINT #2:SEG$(B$,LEN(B$)-2,3);
320 IF A>0 THEN 340
330 PRINT #2:TAB(28);"Y";
340 PRINT #2:CHR$(13);: NEXT LOOP
345 CLOSE #2
350 CLOSE #1
360 END
```

212 asks for a drive number and filename for the output catalog file. The following format is expected:  
DSKx.FILENAME

215 opens the output file.

345 closes the output file.

The addition in line 340—CHR\$(13)—is to print a carriage return after each catalog line. We did this because we expect most users will load a number of catalog files into memory using TI-Writer, and perhaps reformat them. This will prevent the lines from running together on reformatting. Also, the carriage returns may be of use if you resort the catalog files.

Most of the other changes are minor and were done to make the catalog file conform to the appearance of the catalog that the program normally outputs to the screen.

We can think of a number of improvements that can be done. Among them are a modification that would print the disk name next to each program or file. Readers who make improvements may wish to submit them as user notes for future publication.

## CC Manager loads from program

CorComp's disk manager program is designed to load only from the power-up screen, which can be an inconvenience. However, it is possible to access it directly from a program, according to Randy Ainsworth, author of RANdY's RumOR RaG on the Source.

According to the Rag, the following three-line program is all that it takes:

```
100 CALL INIT
110 DELETE "LD-CMDS"
120 CALL LINK("MGR")
```

Ainsworth credits Lee Bendick for the program.

## Repairs to TI products

We occasionally get requests for the address for repairs for TI99/4A products manufactured by Texas Instruments.

(Please turn to Page 46)

# Classified

## Software

### TIGERCUB SOFTWARE

Over 130 original entertainment, education and programming utility programs in BASIC and X BASIC on cassette or disk, only \$3 each! 18 different full-disk collections just \$12 each! Descriptive catalog \$1 refundable. TIPS FROM TIGERCUB full-disk collections of 50+ programs and files from Tigercub Tips newsletters, Vol. I, II and III \$15 each, any two \$27, all three \$35, postpaid. NUTS & BOLTS (#1) and #2, full disks of 100+ utility subroutines in X BASIC Merge format, ready to merge into your own programs, \$19.95 each, both for \$37, with documentation, postpaid. 156 Collingwood Ave., Whitehall, OH 43213 v3n10

### MOVE OVER MAX

Here comes YAKMAN, a speech facility that's all mouth. YAKMAN speaks, he spells, he also contains preprogrammed speeches and sound effects. YAKMAN talks forwards, backwards, or in Pig Latin. With YAKMAN you can easily create, edit, and store up to 5 minutes of speech in memory or on tape. Say it now or say it later, say it in 64 different voices. AMAZING! On

tape for \$14.95. A YAKMAN DEMO tape is available for \$5.95 (\$5.00 refundable). Requires Speech Synthesizer and Terminal Emulator II. TRINITY SYSTEMS, 1022 Grandview, Pittsburgh, PA 15237. v3n10

### SPECIAL PRICES

(1.) USA STATES AND CAPITALS GAME, with the excellent map, state nicknames and abbreviations tutor; (2.) BIBLE BOOKS GAME, with 66 books and hundreds of clues; and (3.) YAKMAN (Requires Speech and TE II), an amazing speech facility; are now \$14.95 each (on tape). Any 2 for \$19.95! TRINITY SYSTEMS, 1022 Grandview, Pittsburgh, PA 15237. v3n10

### SUPERBUG II VERSION 2.0

SUPERBUG II Version 2.0 includes several new features and improvements. SUPERBUG II now allows Changing the List Device, Changing Screen Colors, Loading and Saving Program Files, String Searches, and GROM Base Change. The SUPER SPACE version is improved and the manual is increased to 52 pages. Send \$10.00 to Edgar Dohmann, Route 5 Box 84, Alvin, Texas 77511. v3n10

### NAMELOC SOFTWARE

LABELMAKER—make labels the way you want!  
CATALOPE—create custom, cataloged disk jackets.  
TIMETRAVEL—calendars and quizzes. (See June MICROpendium, page 41) Each program \$5 ppd, two for \$8, all three for \$10. XB, disk, 48K, Epson compatible printer required (Prowriter version available also). NAMELOC SOFTWARE, 3971 SE Lincoln, Portland, OR 97214. v3,n9

### TI FORTH UTILITIES

Complete TI Forth Utility System, includes: 9900 Code Disassembler, Forth Decompiler, Fast Screen Dump (Normal/Double size), Unique Sound Utility, Vastly Improved Versions of the 64 and 40 Column Screen Editors. Also Routines for Speech, Windows, True Lowercase Char Set, Plus more. This Software comes Complete with Source Code, Documentation File and a Special Forth Loader for the 8K Super-Cart Module. Requires: E/A, 32K, Disk Drive. \$19.95 (Postage included). Send Check or Money Order to: Mike De Frank, 4374 NW 9th Ave, Pompano Beach, Florida 33064 v3n9

## User Notes

(Continued from Page 45)

Write Daymon Fikes, Texas Instruments, Attn.: Repair, 2305 N. University, Lubbock, TX 79415.

For repair information, call (806) 741-2321.

### Users group changes meeting schedule

The San Fernando Valley 99 User Group has changed its meeting date to 7:30 p.m. the second Wednesday of each month.

The group meets in the Doctor's Conference Room, Sherman Oaks Community Hospital, 4929 Van Nuys Blvd., Sherman Oaks, California.

For further information, write SFV99ers, P.O. Box 1844, Canyon Country, CA 91351 or call (818) 507-6219 or (805) 255-7583.

User Notes is a column of tips and ideas designed to help readers put their home computers to better use. The information provided here comes from many sources, including TI home computer user group newsletters. MICROpendium will pay \$10 for any item sent in by readers that appears in this column. Mail tips to: MICROpendium, P.O. Box 1343, Round Rock, TX 78680.

**Support  
our  
advertisers**

## Systems

### COMPLETE TI99/4A SYSTEM

Must Sell. TI99/4A, CorComp 9900 Expansion System with DS/DD Disk Controller, RS232, 32K 2 DS/DD Disk Drives in power supply, TI-Writer, Extended BASIC, Many other Modules, Hundreds of Disk programs, All instructions and cables, Joysticks, Widget, Speech Synthesizer all in Excellent Condition. \$800. Phone 412-244-8984. Andy Sonon, 2 Hauck Drive, Pittsburgh, PA 15235 v3, n8

### FOR SALE

TI99/4A system. Includes the following hardware: Silver console, P-box with TI disk controller, RS232, TI SS/SD disk drive, Smith Corona TPI letter quality daisy wheel printer with parallel cable, Speech Synthesizer and TI

# Classified

## Systems

joysticks. Software: TI-Writer, TI Extended BASIC cartridge, 99er Magazine programs on tape; and many games on cartridge and disk. Plus many books and magazines. \$500<sup>00</sup> for everything. If you buy it, I'll pay the freight to ship it. Call Dorinda Hardcastle at (303) 858-0326 after 5 p.m. mountain time or write P.O. Box 1557, Grand Junction, Colorado, 81502. v3,n9

### FOR SALE TI99/4A SYSTEM

Includes the following hardware and software: Console, PEB with CorComp DSDD disk controller card, 32K memory, RS232. 1 SSSD disk drive, 1 DSDD disk drive w/external power, color T.V. SOFTWARE: Multiplan, E/A, TI-Artist, 12 command modules, over 50 disks full of software. 1 year of HCM and documentation for appropriate software. Asking \$600 complete. Call Art (W) 602-748-3034 (H) 602-748-8930. v3,n9

## Magnetic Media

### DS/DD CERTIFIED BULK DISKS

100% certified and tested DS/DD disks with reinforced hub ring. Includes tyvek sleeves, labels, and write protect tabs. Only 45 cents each! Minimum order: 50 pieces. Add \$2.00 for shipping. Textaments, 53 Center Street, Patchogue, NY 11772, (516) 475-3480. v3,n9

## Hardware

### FOR SALE

TI Disk Controller Card \$55, TI SSSD Drive (PHP1250) \$55, DSDD Drive (full height) \$70, Digital LA50 Graphics Printer (like new) \$395, C64 Computer (new) \$95, C64 Cassette Drive \$25, Wooden Printer Stands (4.5 in. high—specify 14x23w \$30, 14x21w \$25, or 14x18w \$20). First check, others returned. UPS paid. Dwight Lindley, 414 Long Leaf Acres Dr., Wilmington, NC 28405, 919-395-4039. v3,n9

## Policy

Classified advertising is a unique feature of MICROpendium. The cost is 25 cents per word. Classified display (i.e., special formatting or graphics) is \$9 per column inch. Classified advertisements must be paid in advance. Classified advertisers may request a category under which they would like their advertisement to appear, but the final placement decision is the responsibility of the publisher.

Classified deadlines will be kept open for as long as practical. For the purpose of classified advertising deadlines, any classified ad received later than the first day of any month cannot be assured of placement in the next edition. We will do our best to include every advertisement that is submitted in the earliest possible edition.

The publisher offers no guarantee that any advertisement will be published in any particular issue. Any damages that result either from errors in copy or for failure to be included in any particular edition will be limited to the amount of the cost of the advertisement itself. The publisher reserves the right to reject any advertisement.

The advertiser may elect to publish the advertisement in subsequent editions at the same charge, payable prior to publication. The deadline for carryover classifieds is the same as for new advertising.

In submitting an ad, please indicate whether you would like a refund if it is not published in the requested edition or whether you would like us to hold it for the next edition. Cancellations and refunds cannot be made after the second day of the month.

Send classified advertising to: MICROpendium, P.O. Box 1343, Round Rock, TX 78680.

### COMMERCIAL HARD DISK SYSTEM

Dual full height drive enclosure. Controller can handle four ST-506 compatible drives. Heavy duty power supply and fan. Equipped with 1.5 megabyte drive. New \$499. Requires Myarc WDS/100 personality card for use with TI99/4A.

Greg Chase 309-347-3950 after 5 p.m. CST.

2411 Holly Dr., Pekin, Illinois 61554  
v3,n9

### CORCOMP DISK CONTROLLER

CorComp double density controller card \$99. Rick Matlak (301) 255-1344. v3,n9

### 32K MEMORY SALE

Brand new standalone memory module, smaller than speech synthesizer. Six month warranty. Limited quantity. \$50.00 ppd. Check, MO, MC, Visa. Tachyon Systems, 5125 S. Westwind Way, Salt Lake City, UT 84118. 801-488-3527 v3,n9

## Miscellaneous

### PRODUCTS FOR TI

32K Card \$69.95, GE Data Recorder \$19.95, GRAM Kracker \$140.00, Navarone Cartridge Expander \$21.95, Asgard Lite Pen \$19.95, RF Modulator

\$6.95, TI Keyboard \$5.50, Oldies but Goodies \$3.50, Cassette Interface Cable \$2.95. Add \$2.00 per order shipping and handling. MC/Visa. Call 216-399-5463 Youngtree P.O. Box 197 Leavittsburg, OH 44430. Catalog sent with order or send \$2.00 (refunded with 1st order) v3,n9

### TI 99/4A GENERAL SUPPLIES

**Hardware ★ Software ★ Accessories  
Retail Store ★ Full Mail Order Service**  
We carry a full line of TI computer supplies. Call or write us for information and to join our Mailing List—Free

**\* VISA & Master Card Welcome \***

**No Extra Charge**

**No Handling Fees!**

**For Mail Order Services**

**Factory Authorized**

**Star Printer Service**

**Pilgrims' Pride Hatboro, PA 19040**

**5 Williams La (215) 441-4262**

**Knowledgeable Service**

**Willing Support v3n9**

### HELPCARE

For TI-ARTIST PRINT OPTIONS.

A six page package of instructions and illustrations.

A time saving tool which permits accurate location of screen text to printed page. Very useful when using TI-ARTIST to enhance Banner Messages. For printed copies send \$1.50 and S.A.S.E. (4 1/8 x 9 1/2 inches) to E.M. Smith, 3506 Garden Drive, Knoxville, TN 37918. v3

---

---

# The LEADING monthly devoted to the T199/4A

---

---

### Subscription Fees

\$17 for 12 issues via domestic third class mail  
\$20.50 for 12 issues via domestic first-class mail  
\$20.50 (U.S. funds) for 12 issues Canadian or Mexican delivery  
\$23.50 (U.S. funds) for 12 issues foreign delivery via surface mail  
\$37.00 (U.S. funds) for 12 issues foreign delivery via air mail  
(Texas residents add 87 cents sales tax)

### Address Changes

Subscribers who move may have the delivery of their most recent issue(s) delayed unless MICROpendium is notified six weeks in advance of address changes. Please include your old address as it appears on your mailing label when making an address change.

### Back Issue Policy

Back issues of MICROpendium are available to subscribers only. Those wishing back issues may notify us of the issue(s) desired and include \$1.50 per issue desired in a check or money order. (U.S. and Canada; Texas residents add 5.125% sales tax.) For foreign air-mail delivery, add \$2 per issue, 50 cents per issue surface mail. All prices listed are U.S. funds.  
**OUT OF STOCK: Vol. 1, No. 2 (March 1984)**

Send me the next 12 issues of MICROpendium. I am enclosing \$ \_\_\_\_\_ in a check or money order in U.S. funds (Texas residents add 87 cents sales tax.) Mail to: MICROpendium, P.O. Box 1343, Round Rock, TX 78680

Name \_\_\_\_\_  
Address \_\_\_\_\_  
City \_\_\_\_\_  
State \_\_\_\_\_ ZIP \_\_\_\_\_

v3,n9

The set of numbers on the right of your mailing label indicates the cover date of your last issue.

P.O. Box 1343, Round Rock, TX 78680

Postmaster: Forwarding and return postage guaranteed

BULK RATE  
U.S. POSTAGE PAID  
ROUND ROCK, TX

Permit No. 533

