

P.O. Box 1343, Round Rock, TX 78680

Postmaster: Forwarding and return postage guaranteed

# MICROpendium

Covering The TI99/4A Home Computer And Compatibles

Volume 3 Number 1

February 1986

\$1.50

*Kwa kini kuku alipitia mtaa?  
Kufika sehumu ingine.*

*¿ Por qué atravesó la calle la gallina?  
Para ir al otro lado.*

## LANGUAGES

*Porquoi est-se-que le coque a traversé la choussée?  
Pour arriver à l'autre coté.*

**Warum ist der Hahn über die Straße gegangen?  
Um die andere Seite zu erreichen.**

.....Texas Instruments TI-99/4A — COMPUTERS, COMPONENTS AND SOFTWARE.....

# TEX+COMP<sup>TM</sup>

America's Number One TI computer retailer  
TI-99/4 PRODUCTS AT PROFESSIONAL PRICES

The largest selection  
of software  
for the  
TI-99/4A



Tex Comp continues to stock the world's largest selection of TI Software. The TI Software library on module, disk and cassette was developed from 1979-1983 at a cost of millions and is considered the best in the home computer software field. TI utilized the talents of such industry leaders as Scott Forsman, Milton Bradley, Microsoft Corp., Scott Adams, Addison Wesley Publishing, DLM, Milliken Publishing, Scholastic Inc., Imagic, Spinnaker and the list goes on and on.

## MANAGEMENT

### INFORMATION MANAGEMENT MODULES

PHM 3006	Home Financial Decisions	4.95
PHM 3007	Household Budget Mgt.	4.95
PHM 3012	Securities Analysis	19.95
PHM 3013	Personal Record Keeping	15.95
PHM 3016	Tax/Inves Rec Keep (Disk Req.)	4.95
PHM 3022	Personal Real Estate	4.95
PHM 3044	Personal Report Generator	10.95
PHM 3036	Terminal Emulator II	9.95
PHM 3111	TI Writer (word processing)	38.75
PHM 3113	Multiplan (spreadsheet)	38.95

### DISKETTE PROGRAMS

PHD 5001	Mailing List (PIO Upgrade)	12.95
PHD 5003	Personal Financial Aids	9.95
PHD 5021	Checkbook Manager	9.95
PHD 5022	Finance Manager	19.95
PHD 5024	Inventory Management	19.95
PHD 5027	Invoice Management	19.95
PHD 5029	Cash Management	19.95
PHD 5038	Lease/Purchase Decisions	9.95
PHD 5075	TI Writer/Multiplan Upgrade	9.95

### CASSETTE PROGRAMS

PHT 6003	Personal Financial Aids	9.95
PHT 6038	Lease/Purchase Decisions	9.95

## EDUCATION

### MODULES

PHM 3002	Early Learning Fun	4.95
PHM 3003	Beginning Grammar	4.95
PHM 3004	Number Magic	4.95
PHM 3008	Video Chess	14.95
PHM 3010	Physical Fitness	9.95
PHM 3020	Music Maker	9.95
PHM 3021	Weight Control & Nutrition	10.95
PHM 3084	Touch Typing Tutor	10.95
PHM 3144	Early Logo Fun	11.95
PHM 3109	TI Logo II (32K req.)	19.95
PHM 3016	Early Reading (Speech)	9.95
PHM 3043	Reading Fun	9.95
PHM 3046	Reading On	9.95
PHM 3047	Reading Roundup	9.95
PHM 3048	Reading Rally	9.95
PHM 3082	Reading Flight	9.95
PHM 3027	Addition & Subtraction I	9.95
PHM 3028	Addition & Subtraction II	9.95
PHM 3028	Multiplication I	9.95
PHM 3049	Division I	9.95
PHM 3050	Numeration I	9.95
PHM 3051	Numeration II	9.95
PHM 3059	Scholastic Spelling 3	9.95
PHM 3080	Scholastic Spelling 4	9.95
PHM 3081	Scholastic Spelling 5	9.95
PHM 3082	Scholastic Spelling 6	9.95
PHM 3088	Computer Math Games VI	9.95
PHM 3090	Milliken Addition	9.95
PHM 3091	Milliken Subtraction	9.95
PHM 3092	Milliken Multiplication	9.95
PHM 3093	Milliken Division	9.95
PHM 3094	Milliken Integers	9.95
PHM 3095	Milliken Fractions	4.95
PHM 3098	Milliken Number Readiness	4.95
PHM 3099	Milliken Laws of Arithmetic	4.95
PHM 3100	Milliken Equations	4.95
PHM 3101	Milliken Mass of Formulas	4.95
PHM 3114	Alligator Mix	6.95
PHM 3116	Alien Addition	6.95
PHM 3117	Dragon Mix	8.95
PHM 3118	Minus Mission	6.95
PHM 3119	Meteor Multiplication	6.95
PHM 3177	Face Maker	9.95
PHM 3178	Story Machine	9.95

### DISKETTE PROGRAMS

PHD 5009	Music Skills Trainer	9.95
PHD 5018	Market Simulation	9.95
PHD 5030	Speak & Spell (Speech Ed Req.)	9.95
PHD 5031	Speak & Math (TE II Req.)	9.95
PHD 5042	Spell Writer (TE II Req.)	9.95
PHD 5028	Bridge Bidding I	9.95
PHD 5039	Bridge Bidding II	9.95
PHD 5041	Bridge Bidding III	9.95
PHD 5020	Music Maker Demo (Module Req.)	9.95

### CASSETTE PROGRAMS

See disk versions for requirements i.e. TEII		
PHT 6009	Music Skills Trainer	8.95
PHT 6011	Computer Music Box	8.95
PHT 6018	Market Simulation	8.95
PHT 6031	Speak & Math	9.95
PHT 6042	Spell Writer	9.95
PHT 6028	Bridge Bidding I	9.95
PHT 6039	Bridge Bidding II	9.95
PHT 6041	Bridge Bidding III	9.95

## MBX UNIT \$64.95

### BRIGHT BEGINNINGS SERIES

PHM 3154	Terry Turtle's Adventure (MBX Expansion System Required)	9.95
PHM 3155	I'm Hiding (MBX Expansion System Required)	9.95
PHM 3156	Honey Hunt (MBX Expansion System Required)	9.95
PHM 3157	Sound Track Trolley (MBX Expansion System Required)	9.95

### ARCADE PLUS SERIES

PHM 3148	Championship Baseball (MBX Expansion System Required)	9.95
PHM 3149	Space Bandit (MBX Expansion System Recommended)	9.95
PHM 3150	Sewermania (MBX Expansion System Recommended)	9.95
PHM 3151	Bigfoot (MBX Expansion System Recommended)	9.95
PHM 3152	Meteor Belt (MBX Expansion System Recommended)	9.95
PHM 3153	Super Fly (MBX Expansion System Recommended)	9.95

## HOME ENTERTAINMENT

### MODULES

PHM 3008	Football	9.95
PHM 3018	Video Games I	4.95
PHM 3023	Hunt the Wumpus	4.95
PHM 3024	Indoor Soccer	8.95
PHM 3025	Mind Challengers	10.95
PHM 3030	Amazing	4.95
PHM 3052	Tombstone City	4.95
PHM 3053	TI Invaders	4.95
PHM 3054	Car Wars	4.95
PHM 3057	Munch Man	4.95
PHM 3042T	Tunnels of Doom (with cass.)	8.95
PHM 30420	Tunnels of Doom (Disk)	8.95
PHM 3056	Alpiner	4.95
PHM 3110	Chisholm Trail	8.95
PHM 3112	Parasc	4.95
PHM 3031	The Attack	4.95
PHM 3032	Blasto	4.95
PHM 3033	Blackjack & Poker	15.95
PHM 3034	Hustle	6.95
PHM 3036	Zero Zap	8.95
PHM 3037	Hangman	6.95
PHM 3038	Connect Four	8.95
PHM 3087	Othello	9.95

## SPECIAL OFFER

Brand New Original Black & Silver TI-99/4A console only \$79.95. Runs all third party modules and comes with 1 year TI factory warranty.

\*Shipping, handling & insurance on this special offer is \$10.00 (Continental U.S.) to any UPS deliverable address. HA, AL, Canada and APO slightly higher.

# Texas Instruments TI-99/4A Home Computer

Tex-Comp purchased TI's inventory of these outstanding titles in order to continue its support of the TI-99/4A user, and also continually acquires inventory from leading retailers and distributors who have discontinued home computer sales.

With its five warehouses and financial resources, Tex-Comp has been able to assure you, the TI-99/4A user continued support.



PHM 3041T	Adventure & Pirate Adv. (Cass.)	6.95
PHM 3041D	Adventure & Pirate Adv. (Disk)	6.95
<b>ADVENTURE SERIES ON CASS OR DISK (SPECIFY)</b>		
	Adventureland	9.95
	Mission Impossible	9.95
	Voodoo Castle	9.95
	The Count	9.95
	Strange Odyssey	9.95
	Mystery Fun House	9.95
	Pyramid of Doom	9.95
	Ghost Town	9.95
	Savage Island I & II	9.95
	Golden Voyage	9.95
	Ironheart Adventure (Not Scott Adams)	9.95
	<b>SPECIAL ALL ABOVE ADVENTURES ON DISK OR CASSETTE INCLUDING IRONHEART</b>	<b>49.95</b>
	Buckaroo Bonzai	19.95
	Soccerer of Claymorgue Castle	19.95
	Spiderman	19.95
	Hulk	19.95

<b>DISKETTE PROGRAMS</b>		
PHD 5002	TI-Trak (with new TEII Ver.)	9.95
PHD 5010	Mystery Melody	9.95
PHD 5015	Oldies But Goodies I	9.95
PHD 5017	Oldies But Goodies II	9.95
PHD 5025	Sat. Night Bingo (Speech) Ex-Basic	9.95
PHD 5037	Draw Poker (Ex-Basic Req.)	9.95

<b>CASSETTE PROGRAMS</b>		
PHT 8002	TI-Trak TE-II & Speech	9.95
PHT 8010	Mystery Melody	7.95
PHT 8015	Oldies But Goodies I	7.95
PHT 8017	Oldies But Goodies II	7.95
PHT 8028	Sat. Night Bingo (Speech) Ex-Basic	7.95
PHT 8037	Draw Poker (Ex-Basic Req.)	7.95

<b>TI ARCADE STYLE MODULES AND RECENT RELEASES</b>		
PHM 3149	Space Bandit (MBX Expansion System Recommended)	9.95
PHM 3150	Sewermania (MBX Expansion System Recommended)	9.95
PHM 3151	Bigfoot (MBX Expansion System Recommended)	9.95
PHM 3152	Meteor Belt (MBX Expansion System Recommended)	9.95
PHM 3153	Super Fly (MBX Expansion System Recommended)	9.95
PHM 3220	Microsurgeon	9.95
PHM 3219	Super Demon Attack	9.95
PHM 3224	Moonsweeper	9.95
PHM 3145	Snaggl	5.95
PHM 3229	Hopper	4.95
PHM 3233	Burgertime	9.95
PHM 3194	Jawbreaker II	5.95
PHM 3227	Congo Bongo	15.95
PHM 3188	Treasure Island	11.95
PHM 3189	Return to Pirates Island	11.95
PHM 3228	Buck Rodgers	15.95
PHM 3225	StarTrek	15.95
PHM 3222	Fathom	9.95
PHM 3148	Munchmobile	11.95
PHM 3197	Stymoids	15.95

## COMPUTER PROGRAMMING AIDS

<b>MODULES</b>		
PHM 3026	Extended Basic & Manual	49.95
PHM 3055	Editor Assembler	19.95
PHM 3058	Mini Memory (With Writer)	38.95
<b>DISKETTE PROGRAMS</b>		
PHD 5007	Teach Yourself 99/4A Basic	9.95
PHD 5019	Teach Yourself Ex-Basic	9.95
PHD 5004	Programming Aids I	9.95
PHD 5006	Programming Aids II	9.95
PHD 5012	Programming Aids III	9.95
PHD 5077	Programming Aids I, II, & III	24.95
PHD 5067	Beginning Basic Tutor	9.95
PHD 5078	Text to Speech (English)	9.95
PHD 5098	TI Forth (Ed Assam Req.)	19.95
PHD 5079	TI Forth Demo Disk (Ed Assam)	9.95
PHD 5079	Forth Source Code (2 Disks)	11.95
<b>CASSETTE PROGRAMS</b>		
PHT 8006	Programming Aids I	8.95
PHT 8007	Teach Yourself 99/4A Basic	8.95
PHT 8019	Teach Yourself Ex-Basic	8.95
PHT 8067	Beginning Basic Tutor	8.95

## MATH AND ENGINEERING

<b>DISKETTE PROGRAMS</b>		
PHD 5008	Math Routine Library	9.95
PHD 5008	Electrical Engineering Lib.	9.95
PHD 5013	Graphing Package	9.95
PHD 5016	Structural Engineering Lib.	9.95
PHD 5044	AC Circuit Analysis	9.95
<b>CASSETTE PROGRAMS</b>		
PHT 8006	Math Routine Library	8.95
PHT 8008	Electrical Engineering Lib.	8.95
PHT 8013	Graphing Package	8.95
PHT 8016	Structural Engineering Lib.	8.95
PHT 8044	AC Circuit Analysis	8.95

## TI-COUNT SMALL BUSINESS SOFTWARE



General Ledger	89.95
Accounts Receivable	89.95
Accounts Payable	89.95
Inventory	89.95
Payroll	89.95
Mail System	39.95

**ALL 6 FOR \$349.95**

Send for New 1986 Tex-Comp catalog & buyer's guide only \$2.00 (comes with \$5 savings certificate)

### Drastic Reductions



 	<b>VISA and MASTERCARD HOLDERS CALL DIRECT (818) 366-8631</b>	<small>SEND ORDER AND MAKE CHECKS PAYABLE TO</small> <b>TEX-COMP™</b> <small>P O BOX 22861 - GRANADA HILLS, CA 91344</small>	 <b>Texas Instruments</b> <small>AUTHORIZED DEALER</small>
<small>add 3% for credit card orders</small>		<small>TERMS: All prices F.O.B. Los Angeles. For fastest service use cashiers check or money order. Add 3% shipping and handling (\$3.00 minimum). East of Mississippi 4 1/2%. (Free shipping on all software orders over \$100.00). Prices and availability subject to change without notice. We reserve the right to limit quantities.</small>	
<small>NOTE: Payment in full must accompany all orders. Credit Card, Company Check or Money Order for immediate shipment. Personal checks require up to 4 weeks to clear. California orders add 8 1/2% sales tax.</small>		<small>1986</small>	



# Contents

## MICROpendium

MICROpendium is published 12 times annually in Round Rock, Texas. No material published in the pages of MICROpendium may be used without permission of the publisher. Computer user groups that have signed exchange agreements with MICROpendium may excerpt articles appearing in MICROpendium without prior approval.

While all efforts are directed at providing factual and true information in published articles, the publisher cannot accept responsibility for errors that appear in advertising or text appearing in MICROpendium. The inclusion of brand names in text does not constitute an endorsement of any product by the publisher. Statements published in MICROpendium which reflect erroneously on individuals, products or companies will be corrected upon contacting the publisher.

Unless the author specifies, letters will be treated as unconditionally assigned for publication, copyright purposes and use in any other publication or brochure and are subject to MICROpendium's unrestricted right to edit and comment.

Display advertising deadlines and rates are available upon request.

All correspondence should be mailed to MICROpendium at P.O. Box 1343, Round Rock, TX 78680. We cannot take responsibility for unsolicited manuscripts but will give consideration to anything sent to the above address. Manuscripts will be returned only if a self-enclosed, stamped envelope is included.

All editions of MICROpendium are mailed from the Round Rock (Texas) or Smithville (Texas) Post Office. Subscriptions are \$15 for 12 issues, delivered via third class mail. In Canada, add \$3.50. Subscribers in the United States who wish first class delivery may also add \$3.50 to the basic subscription price.

Mailing address: P.O. Box 1343, Round Rock, TX 78680  
Telephone: (512) 255-1512  
Source: TI4596

John Koloen.....Publisher  
Laura Burns.....Editor  
Mack McCormick....Technical Editor

### Coming next month

- Reports from the fairs
- How-to on relocating Triple-Tech reset switches
- Word counter for TI-Writer

# Table of Contents

## Habla usted Assembly?

A survey of the wealth of languages available for users of the TI.....Page 12

## A quiet cooling fan for the P-box

The step-by-step method by which you can replace that noisemaker yourself.....Page 22

## RAMdisk sells as kit or assembled

From Horizon Computer Limited, a 104K card which can be inserted into the P-box.....Page 25

## Proofreader detects errors

A help for the BASIC programmer.....Page 28

## Festivals, festivals!

From coast to coast, and in Australia, too.....Page 34

## Let there be sound

Another in our series of assembly language tutorials by Mack McCormick.....Page 35

## Reviews

Night Mission.....Page 36

Peripheral Diagnostic Module.....Page 37

BA-Writer.....Page 38

## Newsbytes

A vocabulary builder, a network for users groups and Asgard on The Electronic Mall.....Page 40

## User Notes

Converting BASIC to XBASIC, reading DV/80 files without TI-Writer; and finding strings in XBASIC..Page 42

Classified.....Page 46

# Sensational Prices!!!

... On Our Most Popular Hardware and Software!!

## MYARC™ 128K Card!!

Step up to big-time personal computing with this powerful new card from Myarc for your expansion box! Now you can have access to bank-switched 32K blocks of memory. This exciting card also includes RAM disk and print spooler routines. Store programs or files in memory and load them instantly! A fantastic productivity aid for users of TI-Writer or similar programs where files are changed frequently. The print spooler lets you "print" at high speed directly to memory — great for downloading files or text.

- 34324 Myarc 128K Card **\$199.00**
- Extended BASIC Level IV. Requires Myarc 128K card. **\$69.95**
- SPECIAL! Myarc 128K card and Ext'd. BASIC Level IV. **\$249.00**



from CorComp...  
**Now Your Computer Can Keep Perfect Time!**

### TRIPLE TECH

An exciting new multifunction board from CorComp that plugs into your expansion box!

**Clock/Calendar:** "Real-time" clock lets you access Year, Month, Date, Day, Hours, Minutes and Seconds easily from BASIC or Extended BASIC.

**Printer Buffer:** Holds up to 64K of output copy and features a duplication function.

**Speech Synthesizer Connection:** Let's you hide your speech synthesizer inside your expansion box.

All three functions in one economical package!

- 34843 Triple Tech **\$129.00**

### CLOCK/CALENDAR

Stand-alone unit plugs into the side of the computer and keeps track of Year, Month, Date, Day, Hours, Minutes and Seconds. Battery backup keeps time for over six months, even when power to the computer is turned off.

- 34639 Clock/Calendar Stand Alone **\$79.00**

## THE 69¢ micro DISKETTE!



Are you paying too much for diskettes? Try our first quality, prime, 5 1/4" diskettes (no rejects, no seconds) at these fantastic sale prices and save, save, SAVE! Disks are packaged in boxes of 50; each box contains 5 shrink-wrapped 10-packs that include diskettes in sleeves, labels, and write-protect tabs.

Each diskette is certified to be 100% error free and comes with a lifetime warranty (if you have a problem, we'll replace the diskette). All diskettes include hub reinforcement rings and write-protect notch.

- 32391 SS, DD Diskettes **\$34.50**  
(69¢ each!)

- 32403 DS, DD Diskettes **\$44.50**  
(89¢ each!)



**FREE!**

**"EVERYTHING BOOK"**

For the  
**TI Home Computer**  
Order Item #25982



AVAILABLE FROM  
YOUR FRIENDS AT



We gladly accept  
mail orders!

P.O. Box 6578  
South Bend, IN 46660

Questions? Call  
**219/259-7051**



## micro Extended BASIC

MicroPal's Extended BASIC package now includes two free software programs! Bestsellers **Typewriter** and **Name-It** from Extended Software are included in disk and cassette versions with complete manual — absolutely free!! You can immediately begin using the power of Extended BASIC for word processing and data base functions.



MicroPal Extended BASIC is unconditionally guaranteed to be 100% compatible with all programs written in TI Extended BASIC. With this powerful, high-level language, programmers

can have automatic access to the 32K memory expansion, utilize sprite graphics for smooth motion and animation, auto-load disk based programs, and add speech with a 400 word built-in vocabulary! Package includes Extended BASIC on a convenient plug-in cartridge with 240 page manual. Sug. Retail \$89.95

- 32967 **ONLY \$69.95!!**

Special Price just for  
Micropendium readers...



## HALF-HEIGHT DISK DRIVE

This double-sided, double-density half-height disk drive provides up to 360K of storage when used with CorComp or Myarc disk controller cards (operates as single-sided, single-density drive with TI controller for 180K of storage). The drives are shipped "bare" and can be installed in TI Peripheral Expansion Box; or may be used externally by installing in Box with Power Supply. Hook-up cables are required; please contact our Customer Service Department to determine correct cables for your system.

- 31031 Disk Drive **\$99.95**
- 20164 External Box with Power Supply **\$59.95**

## BEST-SELLING HARDWARE!

### STAR MICRONICS SG-10 PRINTER

- 33251 **\$229.00**

Latest model! Draft quality at 120 cps, near letter quality at 30 cps. 2K print buffer.



- 30235 AXIOM PARALLEL PRINTER INTERFACE... **\$ 69.95**
- 29784 CORCOMP RS-232 INTERFACE... **\$127.00**
- 29802 CORCOMP 9900 MICRO-EXPANSION SYSTEM... **\$329.00**
- MYARC or CORCOMP RS-232 CARD... **\$ 79.95**
- 32972 MYARC DISK CONTROLLER CARD... **\$169.95**
- 29770 CORCOMP DISK CONTROLLER CARD... **SALE! \$159.95**
- 13315 CORCOMP 32K MEMORY CARD... **\$ 99.95**
- 20164 BOX WITH POWER SUPPLY for external disk drive... **\$ 59.95**
- 31173 WICO 3-WAY GATELOCK JOYSTICK... **\$ 24.95**
- 10285 WICO TI ADAPTER... **\$ 4.95**
- 31007 PROSTICK II. Comes with TI adapter... **\$ 24.95**
- 37321 SUPER STICK. Requires TI adapter... **\$ 7.95**
- 13329 NAVARONE CARTRIDGE EXPANDER... **\$ 29.95**



SHIPPING CHARGES	
ORDER AMOUNT	CHARGE
less than \$20.00	\$3.75
\$20.00-\$39.99	4.75
\$40.00-\$74.99	5.75
\$75.00-\$149.99	6.75
\$150.00-\$299.99	7.75
\$300 & up	8.75

NO EXTRA FEE FOR CHARGES



We verify charge card addresses.

**ORDER TOLL FREE**  
**1-800-348-2778**

Ad  
M4K



# Comments

## BASIC/XBASIC column coming

Here it is, the start of MICROpendium's third year of publication. The credit for this belongs to the support of our loyal readership, without whom we would never have lasted this long. We hope that we've provided a service that keeps you in touch with the TI99/4A community and helps you get more out of your computer.

We also appreciate your encouragement, which continues to make opening the mail a welcome endeavor.

Unfortunately, over the past two years we have failed to get a handle on getting the magazine out in a timely fashion. Most of this has to do with what happens after we deliver the magazines to the post office. Our local postal officials have been very helpful in trying to track down the reasons some subscribers receive their copies late. So far, we've found no quick fix.

As an illustration, a subscriber recently notified us that a friend who lived within a block of him received his MICROpendium a week before he had. By the time he received his copy, he'd already read his friend's copy. There's no explanation for this, since his copy and his friend's copy left our local post office in the same mail sack. Probably both copies were in the same bundle, and yet somehow one was delivered a week or more later than the other. Fortunately, if such can be said of it, this seems to be a random event since the same readers seldom contact us about late delivery more than once. Every month we are contacted by a handful of subscribers who have not received their magazines by the end of the cover month. This shouldn't happen, we're told, but it does.

### BASIC/XBASIC COLUMN TO START

Something we can have an effect on, however, is the quality of the magazine, and next month we'll be introducing a new column and columnist, Lee Wilkerson. Lee will be covering BASIC and Extended BASIC programming, offering advice and tips on how to get more out of your programs.

### ASSEMBLY TUTORIAL CONTINUES

Mack McCormick's assembly language tutorial continues this month with a brief look at using sound. While we have yet to receive all materials having to do with file management techniques in assembly, we are working on it (Mack's in Germany and getting through is a problem). Regardless, next month we hope to see another installment.

### BACK ISSUES AND FREWARE

Our complete listing of Freeware, for which many of you have sent, has not been printed as of this writing. We hope to get it off to the printers while this issue is being printed. Over-optimism about the time it takes to do things seems to be a characteristic shared by many of those involved in developing products for the TI.

We keep getting inquiries about our back issues. They are still all available, though we are beginning to get low on supplies of our very first issue. There is no additional shipping charge for back issues sent to addresses in the United States, Canada or Mexico, but the price is the same whether you order one issue or two dozen—\$1.35 per copy.

—JK

## Reviewed in MICROpendium

### 1984

**February:** B-1 Nuclear Bomber, Tandon TM-100 Disk Drive, Void, Beanstalk Adventure, Microsurgeon, On Gaming, Database 500

**March:** Star Trek, Escape From Balhazar, Garkon's Getaway, Sky Diver, Mail-Call, Pro-writer 8510 Printer

**April:** Monthly Budget\$ Master, Budget Master, Home Budget, Thief, Donkey Kong, Khe Sanh

**May:** Companion Word Processor, Q\*Bert, Mad-Dog I & II, Programs for the TI Home Computer

**June:** Creative Expressions Accounts Receivable/Accounts Payable, CDC 9409 Disk Drive, Starship Concord, Lost Treasure of the Aztec, ASW Tactics II

**July:** Theon Raiders, Introduction to Assembly Language for the TI Home Computer, Game of Wit, Pole Position

**August:** TE-1200, Tower, Galactic Battle, Galaxy

**September:** Wycove Forth, 99/4 Auto Spell-Check, QUICK-COPYer, Wizard's Dominion, Anchor Automation Mk XII Modem

**October:** Killer Caterpillar, ZORK I, Defender

**November:** 9900 Disk Controller Card/Manager, Super Bugger, Transtar 120S printer, Floppy-Copy, Data Base-X

**December:** Gravity Master, Data Base Manager System, Learning 99/4A Assembly Language Programming

### 1985

**January:** Super Sketch, Foundation Computing 128K Card, PTERM-99, TI-Runner

**February:** Super Extended BASIC, Beginning Assembly Language for the TI, ZORK II

**March:** Morning Star Software CP/M Card, WDS/100 Winchester Disk Drive, Sketch Mate,

BMC Color Monitor

**April:** 9900 Micro Expansion System, Disk + Aid, Gemini 10X-15X

**May:** Character Sets and Graphics Design, Draw 'N Plot

**June:** GRAPHX, DATA BASE I

**July:** Acorn 99, Advanced Diagnostics

**August:** Model Dow-4 Gazelle, TI-Artist, PC-KEYS, Not-Polyoptics' Bankroll

**September:** Midnite Mason, Myarc 32K/128K Card, GRAPHX Companion

**October:** 4A/TALK, Extended BASIC II Plus, XB Detective, Console Writer 2.1

**November:** Foundation Z80A/80-column cards, 9900BASIC, Adventure Editor

**December:** Display Enhancement Package, Triple Tech

### 1986

**January:** BITMAC, Starcross

## **SST Expanded Basic Compiler System**

**"The most powerful high level language available for the T.I./4A"**

**NOW ONLY ~~\$49.00~~ \$25.00**

The **SST EXPANDED BASIC COMPILER** contains all of the features of the **SST BASIC COMPILER**, plus most of the features of **EXTENDED BASIC**. It also includes many commands that are not available in **TI BASIC** or **TI EXTENDED BASIC**. A major feature of the **SST EXPANDED BASIC COMPILER** is the ability to add your own commands. If you have need of a command not commonly found in Basic, you can easily add it to our compiler (*Editor/Assembler* module only).

The **SST EXPANDED BASIC COMPILER** package translates a Basic program into TMS9900 machine language, resulting in a great gain in program execution speed. The compiled commands are up to 160 times faster than the corresponding commands in **TI BASIC** or **EXTENDED BASIC**. For a comparison we used our Compiler to run the benchmark program for making change in the April 1984 MICROpendium. This program takes over 30 minutes in **TI BASIC**. When the program was compiled using the **SST EXPANDED BASIC COMPILER**, the program ran in 37 seconds. In fact, you can compile the program, save it on a disk, recall it, run it and still be considerably faster than **TI BASIC**.

A second benchmark program appeared in the November 1984 issue of the MICROpendium (page 22). This program took:

209.4 seconds in <b>TI BASIC</b>	7.2 seconds in <b>TI FORTH</b>
219.6 seconds in <b>TI EXTENDED BASIC</b>	4.9 seconds in <b>WYCOVE FORTH</b>
2.5 seconds in <b>SST BASIC</b> or <b>EXPANDED BASIC</b>	

The **SST EXPANDED COMPILER** is also many times faster than **TI PASCAL**.

The **SST EXPANDED BASIC COMPILER** contains most of the standard features of **EXTENDED BASIC** and is especially useful for number crunching, text manipulation and for producing arcade type games. However, some translation of a Basic program may be required.

**SST Software** has invested about two and one half man-years in the development of this package. With the requirements of **Memory Expansion**, **Disk Drive** and either **Editor/Assembler** or **Mini-Memory** the **SST EXPANDED BASIC COMPILER** gives you the following features:

- The ability to use sprites, sound, joyst, graphics, and string functions.
- The ability to write and compile up to 470 lines of Basic code.
- The ability to link compiled programs together as one large system.
- The ability to call up to seven compiled programs from a TI Basic program.
- The ability to dimension up to 1800 element floating point arrays.
- The use of many of the floating point function statements available in TI Basic.
- The ability to do integer arithmetic for extremely fast execution speed.
- The ability to dimension up to a 12000 element integer array using Memory Expansion.
- The use of strings for input, output, character definition and text manipulation.
- The ability to write and debug a Basic program using the TI console and interpreter, and then compile it without the need for retyping.
- The ability to use Bit Map mode for high resolution graphics.
- The ability to add up to five of your own commands.
- The ability to access a disk drive and the RS232 interface.
- The ability to store the compiled program permanently on disk so that it never needs to be compiled again.
- The ability to use the TI Loader for faster loading speeds of compiled programs.
- A manual of more than 60 pages.

## **SST Expanded Basic Compiler System with a High Resolution Graphics Package and Text Mode**

**NOW ONLY ~~\$59.00~~ \$35.00**

This version gives you all the features of the **EXPANDED COMPILER** plus 40 column mode and 12 new commands for high resolution graphics.

**NEW!!**

**PRE/SST Program**

**\$30.00**

A program translator aid which facilitates preparing existing Basic and Extended Basic Programs for processing by the **SST EXPANDED BASIC COMPILER SYSTEM**. Makes developing new programs easier. It converts multiple line statements to single lines. It allows you to convert floating point variables to integer variables for increased speed. It also allows you to use such things as numeric constants and takes care of defining variables and constants. The **PRE/SST PROGRAM** helps you tap the full power of the **SST COMPILER SYSTEM**. (Requires Extended Basic)

**SST SOFTWARE, INC.**

BOX 26 • CEDARBURG, WI 53012 • (414) 771-8415



# Feedback

## Lithium cell lifespan

We have noted...requests for information on TI Mini-Memory replacement cells. Although the shelf life of lithium cells may be upwards of 10 years, the steady drain of even a few microamps standby current and component leakage can cut the life by one-third to one-half. And so we are starting to see Mini-Memory failures more frequently. It has been suggested that the answer is to purchase a cell at the local Radio Shack and solder leads to it. A hot soldering iron applied to the cell may be hazardous and is not recommended.

We can supply exact replacement lithium cells with welded-on leads for \$5 postpaid to Mini-Memory owners anywhere in the continental USA.

**Thomas F. Spillane**  
DIJIT Systems  
4345 Hortensia St.  
San Diego, CA 92103

## Fans and CTRL U

I would like to comment on the STATCO cooling fans described in the December issue....I have built up more stress over the noise from the PE fan than *any* air traffic controller! Consequently, I remained skeptical that anything could make that noise tolerable. Well, take my word, it is short of miraculous. I can hardly hear it at all. My hat goes off to MICROpendium for making the info available and to Paul Johnson of STATCO for saving my health.

As for the control characters in TI-Writer, there are times when you do not want to use Text Formatter, but rather "PF" in the Text Editor. You can access nearly all the control codes without the use of the Transliterations (.TL). The simplest cases are decimal codes less than 31 such as "14" to turn on Double width (Epson printer). From page 146 of the TI-Writer manual, you see that you access these codes by typing CTRL U and then capital N.

The next group of commands need

to be preceded by the "ESCAPE" code. This is character "27". For instance, to get italics on the Epson, the code is 52, preceded by ESC, which is capital "R" from page 146. Type CTRL U, FCTN R, CTRL U and then "4" (the ASCII code for 52).

The most difficult one to "crack" was where the Control code was followed by another number such as required for subscript. Here the sequence is ECS, Decimal code 83, and any number other than "0" (I use "1"). The trick is that the number must be ASCII codes 0-31. In the case of 1, that is CTRL U "A" (see page 146). The sequence is CTRL U, FCTN R, "S", CTRL U, "A". If you want to skip over perforations to 20 lines, the sequence is CTRL U, FCTN R, "N", CTRL U, "T" (CTRL T = ASCII CODE 20).

All of these sequences will also work in Text Formatter, but William Bullock's system is so much simpler and easy to remember. With this one, you definitely have to have a conversion table.

**Clinton A. Chamberlin**  
Mountaintop, Pennsylvania

## ACCEPTable solutions

In the June 1985 issue...a request of mine appeared...for information on how to write an ACCEPT command in Extended BASIC that works just like the existing ACCEPT command but allows entry of full length strings. I was happy to see several replies in following issues, but each solution had problems.

John N. Marx submitted a routine published in the August 1985 issue, but as he indicated, there are problems with editing the strings. Joseph L. Nuvolini Jr. submitted a solution (September 1985) using a string in the ACCEPT command of the form L\$(0+0). [This was misprinted in the magazine as L\$(0^0).] This is an interesting solution. (Why does it work?) But it has some problems, notably, the edge characters are ignored so that characters are displayed on the entire line rather than on columns 1 to 28. Also, *more*

than 255 characters are accepted and this causes problems in future displays of the string entered. A third suggestion from the Atlanta 99 Computer User Group (November 1985) suggested that ACCEPT will accept 255 characters if the SIZE and AT options are not used. This is true, but the program I am writing needs the AT option.

The conclusion is that I've gotten some nice, interesting and instructive suggestions, but none are completely satisfactory. Is there some assembly language programmer out there who could write a good assembly language program for an ACCEPT routine that can accept full length strings and still retain all editing capabilities and options of the existing ACCEPT command? (Also, an explanation of how to link such a routine to an Extended BASIC program would be desirable.)

**George Zinsmeister**  
Sunderland, Massachusetts

## Works like a champ

Your articles like the one in the December issue written by J. Shaw, R. Shaw and D. Collette not only put a bit of excitement on what is for many of us a very practical hobby but they saved us many dollars in the process. I just finished attaching a second disk drive to my computer system and it works like a champ.

**Manuel Fernandez**  
Covina, California

## Memory and drives

Two comments on your December issue. On page 6, under "Good Things for Christmas," the statement that GRAM Kracker does not require a memory expansion is in error. In a conversation with Craig Miller today he confirmed that the memory in the GK is an entirely new memory area and not akin to the 32K on the expansion card.

Item two concerns the article on page 38, "Using an External Drive Internally." The instructions for hooking up the data lines to the external

(Please turn to Page 10)



**9900 + FOR THE TI99/4A  
THE ULTIMATE  
99/4A EXPANSION SYSTEM  
AT A SPECIAL  
INTRODUCTORY PRICE  
FROM TEX-COMP™**

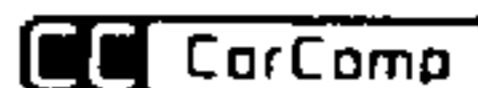
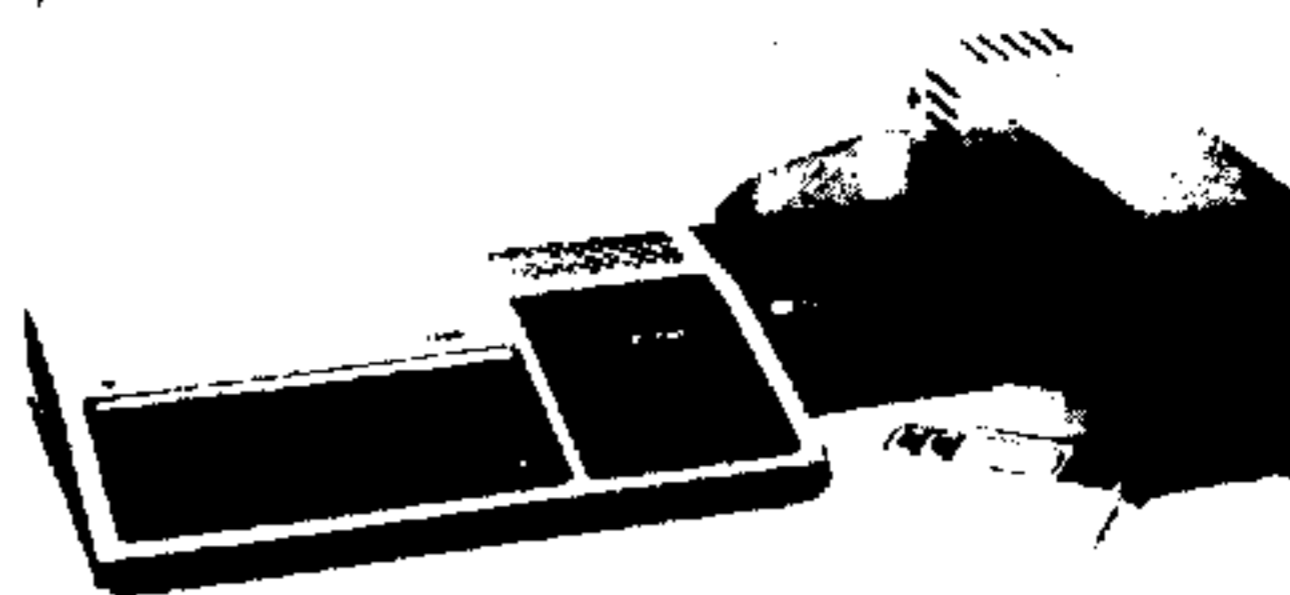

TEX-COMP, the undisputed leader in supplying the 99/4A User, has now put together the finest and most complete expansion system ever offered for the TI99/4A.

**COMPLETE  
EXPANSION SYSTEM  
NOTHING ELSE TO BUY!**

- **9900 Expansion Box & Regulated Power Supply (UL Approved)**
- **32K Memory Upgrade** Adds 32K bytes of Random Access Memory to your system.
- **Double Sided/Double Density Disk Controller** (operates up to 4 drives)
- **RS232 Interface** Lets you add a wide range of other accessories, such as printers or telephone modems, one parallel and 2 serial outputs.
- **1 SS/SD Disk Drive** Allows you to store and retrieve data on 5 1/4-inch single-or double-sided floppy diskettes.
- **1 Disk Drive Case & Regulated Power Supply**  
Handles two 1/2-height drives easily (UL or LAC Approved)
- **New Disk Manager with Improved Disk Utilities**
- **All Cables & Instructions** Including a free TI RS232 Y-Cable.

**ALL FOR  
\$379.95**  
Plus S&H

**For above system with full size DS/DD Disk Drive** \$399.95  
**For above system with a pair of 1/2-height Drives** 539.95

Other leading CorComp Hardware Values:

CorComp RS232 Card (for TI P-Box)		79.95
CorComp 32K Card (for TI P-Box)		99.95
CorComp DS/DD Controller (for TI P-Box)	<b>NEW LOW PRICE</b>	<b>149.95</b>
CorComp 9900 System with Free RS232 Y-Cable	<b>NEW LOW PRICE</b>	<b>299.95</b>
CorComp Stand Alone RS232 with Free Y-Cable	<b>NEW LOW PRICE</b>	<b>99.95</b>
<b>NEW</b> CorComp Stand Alone 32K	<b>NEW LOW PRICE</b>	<b>89.95</b>
<b>NEW</b> Triple Tech P-Box Card (Clock/Buffer)		109.95
<b>NEW</b> 9900 Clock Stand Alone		69.95
"Grom Buster" (for 1983 Consoles)		24.95
Load Interrupt Switch (with <b>FREE</b> Screen Dump Program)		19.95
<b>NEW</b> PDI Diagnostic Module		24.95

**Also available from TEX-COMP at NEW LOWER PRICES:**

TI-99/4A Console w/1-year warranty (Black & Silver model)	79.95
New Star SG-10 Printer w/TI Instructions (replaces Gemini 10X same specs but improved letter quality) with Free Cleaner Kit	239.95
1/2-Height DS/DD Disk Drive (2 will fit in P-Box)	99.95
Full Size DS/SD Disk Drive (exact replacement for TI 1250)	79.95
Full Size DS/DD Disk Drive	99.95
Drive Enclosure with Regulated Power Supply for 2 1/2-height or 1 full Drive	59.95
Cable Kit for 2 1/2-height Drives (for installation in P-Box)	29.95
Cable Kit for Stand-Alone Drives	29.95
RS2323 Y-Cable (Specify if for TI or CorComp system)	10.95

**SEND \$2.00 FOR NEW 1986 CATALOG WHICH INCLUDES A \$5.00 SAVINGS CERTIFICATE.**



VISA and MASTERCARD  
HOLDERS CALL DIRECT  
(818) 366-6631

SEND ORDER AND MAKE CHECKS PAYABLE TO

**TEX-COMP™**

Texas Instruments



P O BOX 33084 — GRANADA HILLS CA 91344 AUTHORIZED DEALER

add 3% for credit card orders

**TERMS:** All prices F.O.B. Los Angeles. For fastest service use cashiers check or money order. Add 3% shipping and handling (\$3.00 minimum) East of Mississippi 4 1/2% (Free shipping on all software orders over \$100.00). Prices and availability subject to change without notice. We reserve the right to limit quantities.

**NOTE:** Payment in full must accompany all orders. Credit Card, Company Check or Money Order for immediate shipment. Personal checks require up to 4 weeks to clear. California orders add 6 1/2% sales tax.

"The Leader of the Pack"

# Feedback

(Continued from Page 8)

drive are correct; however, it is in error with regard to what the edge card connector supplied by TI does. The only thing it does is allow a second drive to be added and accessed as drive number two without changing the disk select jumper. If you ohm out the card you will find that lines 10 and 11 from the disk controller card are dead ended and lines 12 and 14 from the controller go to lines 10 and 12 on the drive, so when the controller asks for drive number two, the external drive is accessed even though the disk select jumper on the external drive is set for drive number one.

I would not recommend connecting two full power drives to the internal power supply of the P-box. I examined a setup like this, although the owner did have an external power supply, and found that both drive motors ran when either drive was accessed although the light only came on for the one that was accessed. I don't deny that there may be some P-boxes out there that will support two full power drives but the reason is more than likely that the particular P-box was built with a power transformer that was larger than usual. I'm sure that TI bought power transformers from a number of vendors and accepted any that met or exceeded the minimum required.

Several years ago I tried to run two half-height Queme drives with the internal power supply and it would not support them. I had to beef up the P-box power supply. I know others that have run two drives successfully but most P-boxes require a separate power supply for an external drive. I would be very careful running two full power drives on the P-box power supply. You might damage a drive by loading down the power supply, or worse, take out the power supply.

**Joe Nuvolini**  
Colorado Springs, Colorado

## Didn't dump TI

Had it not been for MICROpendium, I would have seriously considered

"dumping" my TI and buying another computer. Between your periodical and membership in a TI user's group I have been able to stay "literate" on the TI.

I sincerely hope that you will be able to continue publishing your newsletter and not go under as many others have done. In fact I would very much like to see MICROpendium expand into a periodical that would be comparable to the magazines on the newsstand which are devoted to other makes of computers. I, for one, would be more than happy to pay whatever it takes to subscribe to a dedicated TI magazine. While your product includes a great deal of usable information, I find that the state of the art and the rapid change in the status of software is such that I'm still behind the power curve when it comes to the TI.

Incidentally, I have been trying to modify one of my TI consoles to output RGB signals to my Sears RGB monitor without much success. I have the TI chip, TMS 9918, but the supposedly minor changes in the wiring of the console and the fabrication of an RGB cable have me stumped. If you can provide me with any guidance or advice on this project I would be most appreciative.

**Chris C. Agrafiotis**  
Concord, New Hampshire

(Do any of our readers have suggestions?—Ed.)

## XLATE suggestions

I have run into a few mysterious errors when using XLATE in the past, but over all it is a very useful program.

There are several suggestions I would like to make:

(1) Your article states that the file to be converted should be saved "in the normal way." Rather than use TI-Writer's SF command, one should use PF with the device name DSKX.FILE-NAME. This will print the file to disk in DV80 format without saving the bothersome tab settings.

(2) One may precede the device name with C to automatically strip out carriage returns.

(3) One should also remove all blank lines before saving the file. Blank lines occur frequently in text files downloaded from a database.

**Wayne Stith**  
Richmond, Virginia

## XLATE listing

"XLATE" is an interesting program but the listing you printed (apparently produced by XLATE) illustrated an error in the program. Lines 520 and 530, and 180 and 190, were erroneously concatenated by XLATE. Further, if you MERGE and LIST the product of XLATE, you find the literal "GOTO 260530" is reproduced as "GOTO 63922"!!!!

It's not surprising that the program contains this error, it is surprising that you printed it (apparently) untested.

**Richard G. Minutillo**  
Roslindale, Massachusetts

The error is in the documentation that was published with XLATE, not the program. The program is designed to read a space in column 80 as an end of program line indicator. Thus, program lines of more than 80 characters that contain a space in the 80th position will be concatenated. However, program lines with more than 80 characters that contain something other than a space in the 80th position will not be concatenated. We found that even very long programs—those of 10 kilobytes or more—had only a few lines that had a problem in regards to concatenation. We found two easy methods to deal with this: one is to restructure the program line so that a space does not occur in the 80th position; the other is to break the offending program line into two separate lines.—Ed.

The Feedback column is for readers. It is a forum to communicate with other readers. The editor will condense excessively lengthy submissions where necessary. We ask that writers restrict themselves to one subject for the sake of simplicity. Our only requirement is that items be of interest to persons who use the TI99/4A home computer. Mail Feedback items to: MICROpendium, P.O. Box 1343, Round Rock, TX 78680.



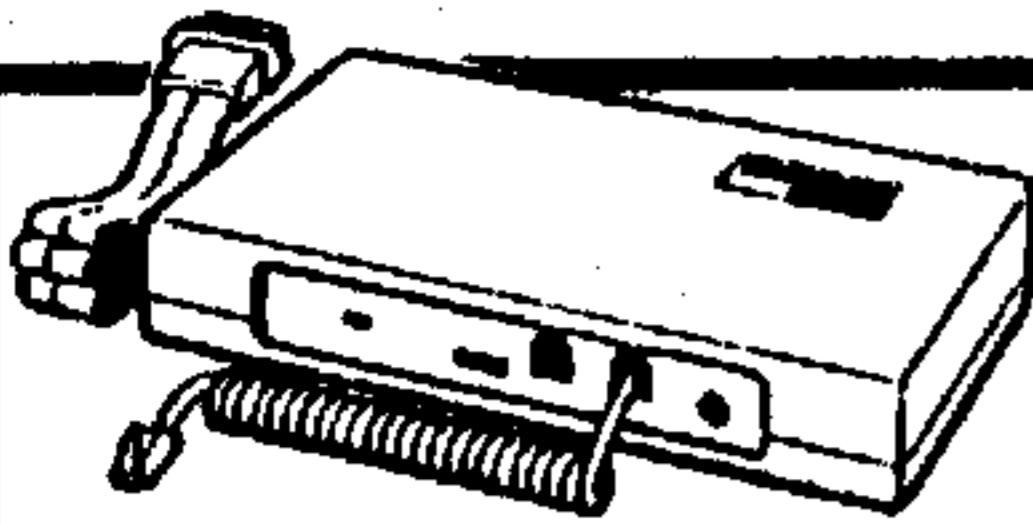

**The SIGNALMAN MARK IIII  
TI-99/4A COMPATIBLE  
300 BAUD MODEM**

**\$74.95**  
including shipping & insurance

**ACCESSORIES**  
9V-DC  
Optional  
Power Supply  
**\$10.95 p.p.**  
For Mark IIII only

Finally, a low cost, direct connect, high quality and super reliable TI-99/4 and 99/4A compatible modem that comes complete and ready to use—just plug it into a RS232 interface or expansion card. **TEII and TEIV + communications software included FREE**

**SPECIAL: CompuServe Starter Kit with 5 free hours of connect time. Reg. \$19.95, ONLY \$10 with any modem on this page when you mention this ad.**

**VOLKSMODEM**

The Complete Low-Cost Plug-In Modem. **\$39.95**

It puts computer-to-computer communications within easy reach of every personal computer owner.

Just plug Volksmodem between any wall phone jack and telephone and put your computer into instant communication with thousands of others. It's that easy. No extra parts or tools are necessary—just one adapter cable and software is all that's needed.

**MONEY SAVING SPECIAL.** Get the Volksmodem (reg. \$59.95), 99/4A modem cable (reg. \$12.95), and Terminal Emulator II (reg. \$9.95) an \$80+ value for **ONLY \$39.95.**

**SPECIAL OFFER**  
Free CompuServe  
Executive Level  
Starter Kit  
(Sign on + 2 free  
premium hours with  
Volks 12)



**VOLKSMODEM 12**  
300/1200 Intelligent Modem **\$199.95**

Hayes Smartmodem Command Structure

- 300/1200 Baud • Bell 103 & 212 A Compatible
- Auto Answer/Auto Dial
- Automatic Speed Mode Selection • Cable Included (18")
- 2-Year Warranty • RS232C Compatible **COMPLETE WITH TI-99/4A CABLE, TEII AND TEIV +**
- Enhanced Noise Immunity

**NEW!**

**A GREAT COMBINATION FOR THE TI-99/4A**

The new CorComp Load/Interrupt Switch  
and "SUPER DUMP" Screen Printout Software   
(by Danny Michael)

By special arrangement with Danny Michael, a talented 99/4A programmer, Tex-Comp is offering a copy of his "Screen Dump" **FREE** with each purchase of the new CorComp Load/Interrupt Switch.





**Complete**  
**\$19.95**  
postpaid

**Comes Complete with Switch and Software**

Print the screen of a BASIC or Extended BASIC program at the press of a function key. Also print the screen of many modules, including Music Maker, Tax Investment Record Keeping, Personal Real Estate, etc.

No need to worry about not having a serial printer for the older TI modules. This new plug-in Load/Interrupt Switch easily inserts between the console and the speech synthesizer or P-Box. Requires 32K, Disk Drive, Extended BASIC. Works only with Epson, Gemini 10X, Star SG10, TI855, and other dot matrix fully Epson compatible printers. Software dumps at regular size, double size, sideways and can reverse screen.

**NOTE:** A ProWriter version of Super Dump is also available (must specify with order).

		VISA and MASTERCARD HOLDERS CALL DIRECT <b>(818) 366-6631</b>	SEND ORDER AND MAKE CHECKS PAYABLE TO	<b>TEX-COMP™</b>	Texas Instruments 
add 3% for credit card orders			<b>24 Hour Order Line</b>	P.O. BOX 23864 - GRANADA HILLS, CA 91304	AUTHORIZED DEALER
TERMS: All prices F.O.B. Los Angeles. For fastest service use cashiers check or money order. Add 3% shipping and handling (\$3.00 minimum). East of Mississippi 4% % (Free shipping on all software orders over \$100.00). Prices and availability subject to change without notice. We reserve the right to limit quantities.			NOTE: Payment in full must accompany all orders. Credit Card, Company Check or Money Order for immediate shipment. Personal checks require up to 4 weeks to clear. California orders add 8% sales tax.		
<b>"The Leader of the Pack!"</b>					

**SEND \$2.00 FOR NEW 1986 CATALOG WHICH INCLUDES A \$5.00 SAVINGS CERTIFICATE.**

# ¿Habla usted Assembly? Sprechen Sie Logo? Parlez-vous XBASIC?

By **RON ALBRIGHT**

At the second annual TI Faire sponsored by the Chicago User Group, the keynote speaker, Don Bynum (former head of the TI Home Computer Division), praised the talents of the 99/4A community. He declared that "there are at least four or five programmers in every large user group today that know more about the innards of the 99/4A than anyone we had at Lubbock in 1983."

This statement was true when made (Nov. 2, 1984) and is even more accurate one year later. Two years after the withdrawal of Texas Instruments from the home computer market, the TI user is in a better position to use his 99/4A computer productively than ever before. Telecommunication, database, graphics and utility software surpass the quality anyone ever thought possible when they first purchased the machine. Further, the outstanding programmers in the 99/4A community have developed new languages for programmers to learn and use.

Since the industry abandonment of the TI computer, three programming languages have been added to the original group (which included BASIC/Extended BASIC, Assembly, Pascal, and Logo). TI released a fifth language, Forth, while pulling out of the home computer market. More recently, Thomas Weithofer released Pilot 99 and Clint Pulley released c99 (an implementation of "small c" for the 99/4A).

A brief overview of this wealth of languages may be of value, with par-

ticular attention to the newest releases: Pilot 99 and c99.

**BASIC/Extended BASIC**—As with virtually all home computers, the resident language available when you turn the 99/4A on is BASIC, which stands for "Beginner's All-purpose Symbolic Instruction Code." Although it is not particularly efficient (and certainly not a breeding ground for good programming habits), it is burned into the chips of most home computers because it was designed (by Dartmouth professors John G. Kemeny and Thomas E. Kurtz) to allow students to learn quickly how to program computers.

It is an "all-purpose" language because it was intended for use by students of the humanities, as well as scientists and engineers. BASIC has that single advantage: it is easy to use.

Like most other home computer manufacturers, TI added an enhanced version of BASIC, called Extended BASIC, which allows multiple statement lines, sprites and improved text display commands.

While most users began programming with BASIC, many rapidly discovered its disadvantages. First (and probably in the long-term, foremost), BASIC tends to breed poor logic habits. A case in point revolves around the ability of the programmer to use "GOTO" and "GOSUB," which allow transfer of control from any line in a program to another line. If a series of lines were drawn to show the sequence that commands were executed in the typically complex BASIC program, the lines would overlap and weave across each other like so many

strands of pasta, leading to the famous, derogatory term, "spaghetti code." While it is possible to write logical, sequenced BASIC code, it is uncommon and requires extraordinary discipline.

The second disadvantage of BASIC is that it is the slowest of the programming languages for the computer to execute. Because each BASIC command actually entails many steps for the computer, the commands must be "interpreted" by the firmware (the ROM, or "read only memory"). The process of interpretation is what produces the slow run time of BASIC programs. Programmers using most other computers can avoid this flaw by writing their code in BASIC and then running the program through a "compiler" to produce a second program. The compiled BASIC is, basically, already interpreted for the computer and, thus, executes much faster. One of the most glaring software deficiencies for the 99/4A is its lack of a BASIC compiler. [SST Software Inc. markets a compiler called Expanded BASIC Compiler System—Ed.] So, while BASIC is most programmers' first language, it is certainly not the best.

**Assembly**—While BASIC/Extended BASIC are considered to be "high-level" languages (which generally means they are easy to use but slow for the computer to execute) assembly language is a "low-level" language (difficult to program but extremely fast in execution.)

Assembly language uses mnemonics  
(Please turn to Page 14)



# UNISOURCE ELECTRONICS, INC.

7006 UNIVERSITY  
P.O. BOX 64240  
LUBBOCK, TX 79464

## ?? MYSTERY SURPRISE GRAB BAG ??

**Guaranteed \$20 software value!!!**

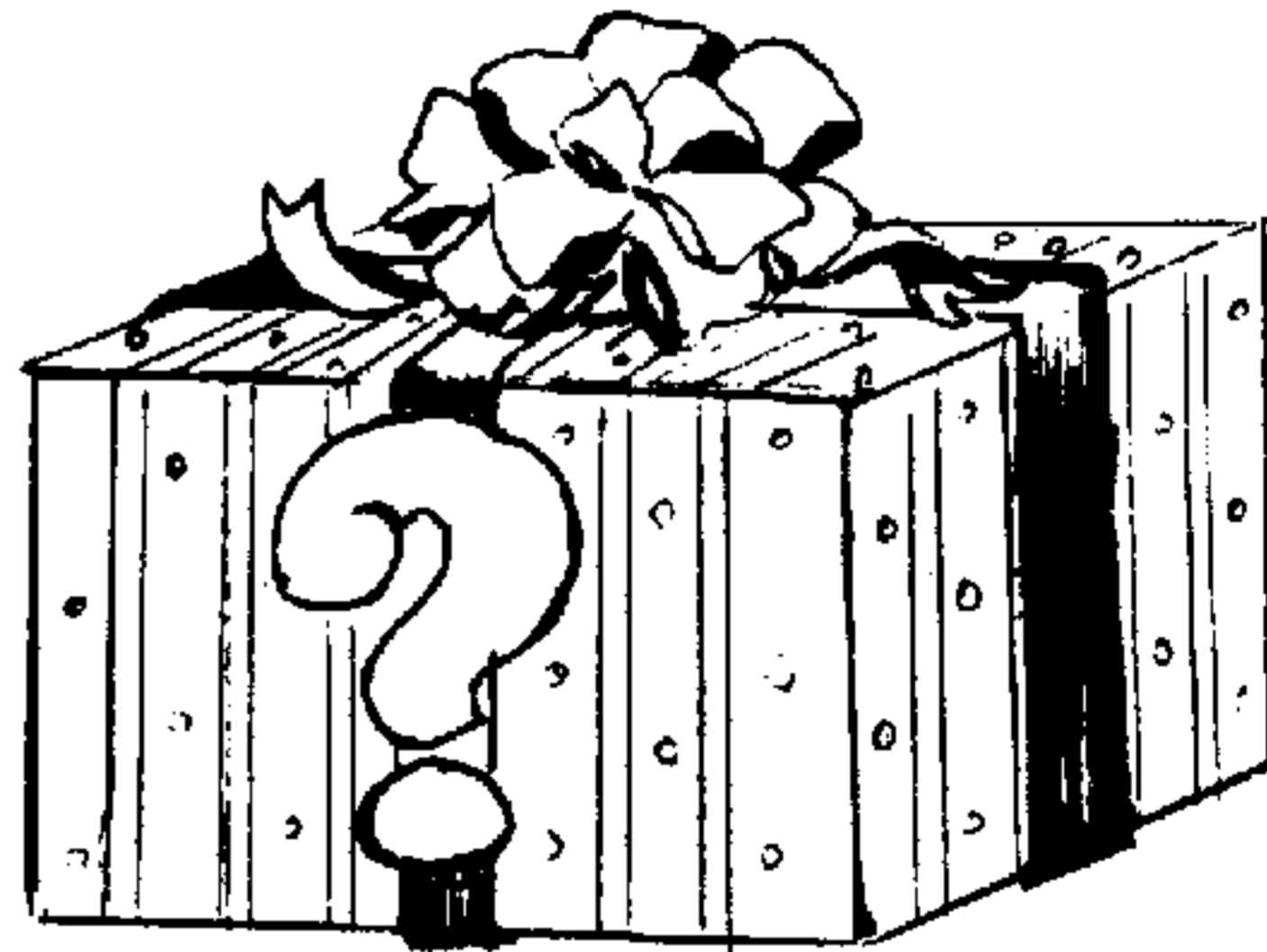

No, we won't tell you what's in it, but we **GUARANTEE** it to be a \$20 value!!

This mystery grab bag assortment of third party software represents a very broad spectrum of software and so is available in any of the four bags below. Please note that we recommend on disk-based software you have 32K additional memory and also Extended BASIC module.

With such an incredible value, we cannot accept returns or exchanges (hey! whaddya want for \$6.95?!) We will replace defective software only with like or similar software.

This is a limited time offer, so **ACT NOW!!!**

### **ENTERTAINMENT BAG**

Cassette SW (Item # **GRAB 1C**)  
or  
Disk SW (Item # **GRAB 1D**)

### **UTILITY & BUSINESS BAG**

Cassette SW (Item # **GRAB 2C**)  
or  
Disk SW (Item # **GRAB 2D**)

### **TI MODULE BAG**

3 Educational (Item # **GRAB 3**)  
or  
3 Entertainment (Item # **GRAB 4**)

Sorry, our \$20 minimum applies to this offer. Please call TOLL FREE and we'll rush you out a catalog containing hundreds of items for your TI 99/4A.

**TOLL FREE: 1-800-858-4580 (in Texas 1-806-745-8834)**

## **UNISOURCE ELECTRONICS, INC.**

7006 UNIVERSITY  
P.O. BOX 64240  
LUBBOCK, TX 79464

# ASSEMBLY AND PASCAL—

(Continued from Page 12)

that, while sometimes hinting at what the command means, are difficult to learn and keep track of. Further, the language requires an extensive understanding of the computer's registers ("closets" where specific bits of information can be stored and moved to and from) and memory locations. Once the assembly code is written, it is run through an assembler, which then produces the lowest level language of all—machine code, a series of zeroes and ones that serve as "on" and "off" switches for the millions of electronic switches in the computer chips. The resultant machine code requires very little memory space, allows total control of the machine by the programmer, and executes at the fastest speed available to any language. For the TI, the language is a bargain at about \$30 for the Editor/Assembler package (assemblers cost upwards of \$150 for the IBM, for example). If you are will-

ing to give it the required amount of midnight oil, assembly language is quite probably the ultimate for machine control and speed.

**Pascal**—Quite early in its history TI provided us with a UCSD Pascal system. Unfortunately, it was much too expensive for the average user. The system included a card for the expansion box and three software packages: a compiler, an assembler/linker and a utilities disk. The system sold for nearly \$600 at introduction in 1982.

Pascal for the TI never really caught on, and that is unfortunate as it is the only "transportable" language. A transportable program is one that can be written on one machine, such as the 99/4A, and run on another, such as the IBM-PC. This is accomplished through the use of a pseudo-code, or "p-code," compiler.

Transportability, which implies hardware-independence, also means it is difficult for the language to access

special features of the host machine (with TI, that is a major weakness; it can be gotten around by combining Pascal with assembly language routines). Despite this weakness, the language is considered by many experts to be the most important one to learn. It embodies the opposite of BASIC (which its originator, Niklaus Wirth, despised).

The essence of Pascal is structure—any Pascal program, large or small, is made up of smaller sub-programs, each of which is itself a structured program. The variables are all specified according to type at the beginning of each program, or sub-program. There are no GOTO statements. Pascal was recently designated by the College Entrance Examination Board as the language to display proficiency in for advanced computer science placement. With falling prices for Pascal systems (going  
(See program, Page 16)



## NO MORE, UNCLE !!!

Tired of being ripped off by your Uncle every year? Then make an exception this year with DA-TAX AUDITOR income tax preparation software package. It includes both the short and the long forms with all widely used schedules, it can recalculate the whole form for different values, has the option of printing the form, contains a calculator window (yes it has windowing) that can be opened any time, etc.

We have versions of this package on disk or cassette for systems with or without Extended BASIC and with or without memory expansion, so please specify your system's configuration when ordering.

DA-TAX AUDITOR can be yours for the amazingly low price of \$9.95 plus \$1.00 Shipping and Handling.

And don't forget that the price of this package is tax deductible.

We could definitely help you with your taxes; too bad we can't do the same for your Uncle.

The DA-TAX AUDITOR can be ordered by check, money order or C.O.D., for C.O.D. please add \$4.00 extra.

Send order to:

DATAx co., 1923 Linden Street,  
Ridgewood, NY 11385  
Tel: (718) 417-0165

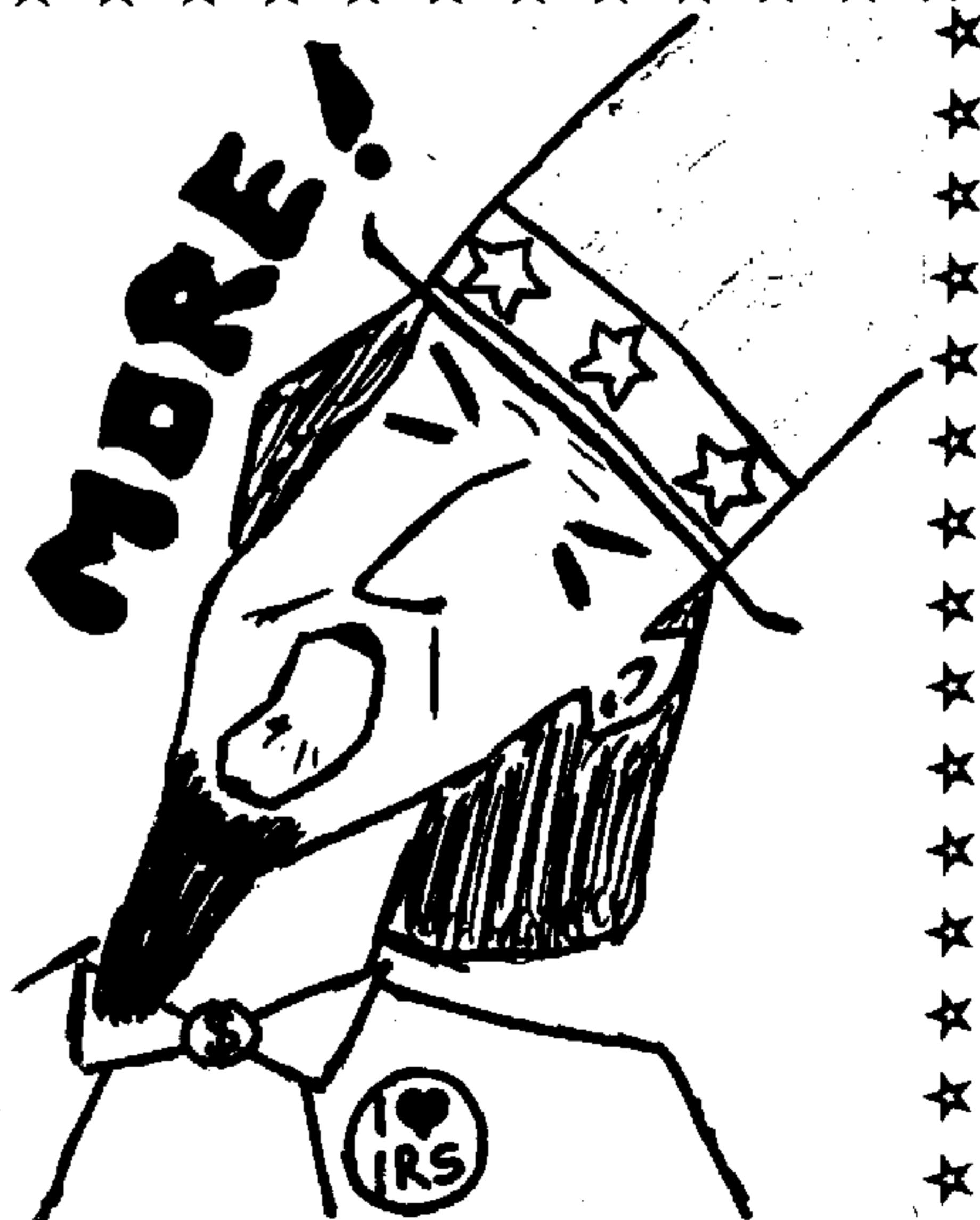



**Sensational Prices!!!**

... On Our Most Popular Hardware and Software!!

**From QUALITY 99 SOFTWARE**



**FANTASTIC SCREEN DUMP**

- ★ Now Dumps Many Cartridge Screens
- ★ Optional Full Page Printout

**SDUMP II.** A fast, resident screen dump program. Print the screen on a printer in only 27 seconds with only one instruction! No programming knowledge required. You load this 100% Assembly Language program once, then it is always ready for instant use from your TI BASIC or Extended BASIC program, or from command module! Now prints in both normal size and big full page (80 column) size. With a load interrupt (sold separately), you can even print the screens from many cartridge-based programs including Tax/Investment, Household Budget, Video Chess, Home Financial Decisions, Securities Analysis, Disk Manager, Personal Real Estate, and many more. (To dump cartridge screens, you must have a load interrupt switch — see below). Supports TI, Epson, Star Micronics, Panasonic, Prowriter, and compatible printers. Requires 32K, and Extended BASIC, or Editor/Assembler, or Mini Memory.

36169 Disk

Sug. Retail \$29.95

**\$25.95**

**TROUBLESHOOT YOUR TI 99/4A SYSTEM! Peripheral Diagnostic Module**

*Save lots of time and money by troubleshooting your TI 99/4A system at home!*

The module plugs into the cartridge slot of the 99/4A and tests the operations of TI and CorComp expansion cards and stand-alone units. The module checks the following peripherals and functions:

**Disk Controller and Drive System**

- Test SS, SD; SS, DD; DS, SD; DS, DD.
- Select each drive for format and test.
- Display head step settings with CorComp card.

**32K Memory**

- Perform bit check and data retention test on 32K memory

**RS-232 Interface**

- Check Port 1 loop to Port 2 without a printer (Requires Loop-Back Plug — included with module).
- Check PIO out to parallel printer.

If you're serious about maintaining your TI 99/4A system in top-notch working condition, you'd be wise to invest in this module. 120 day manufacturer's warranty.

**38412 Peripheral Diagnostic Module** **ONLY \$24.95**

**PLEASE NOTE** — If you have a 1983 version 2.2 TI 99/4A console, you'll need the CorComp '83 Module Adapter to be able to use this module.

**38150 CorComp '83 Module Adapter** **\$27.95**

from



**The Perfect Companion for SDUMP II...**

from



**SCREEN DUMP AID**

**CORCOMP**

**LOAD INTERRUPT SWITCH.**

Designed for use in conjunction with screen dump software like Screen Dump II from Quality Software, this handy device lets you dump many cartridge screens at the touch of a button.

All you have to do is plug the interrupt switch into the side of the computer, load the screen dump program, and run the cartridge program. When you get to the screen you want, just push the button to print the full screen.

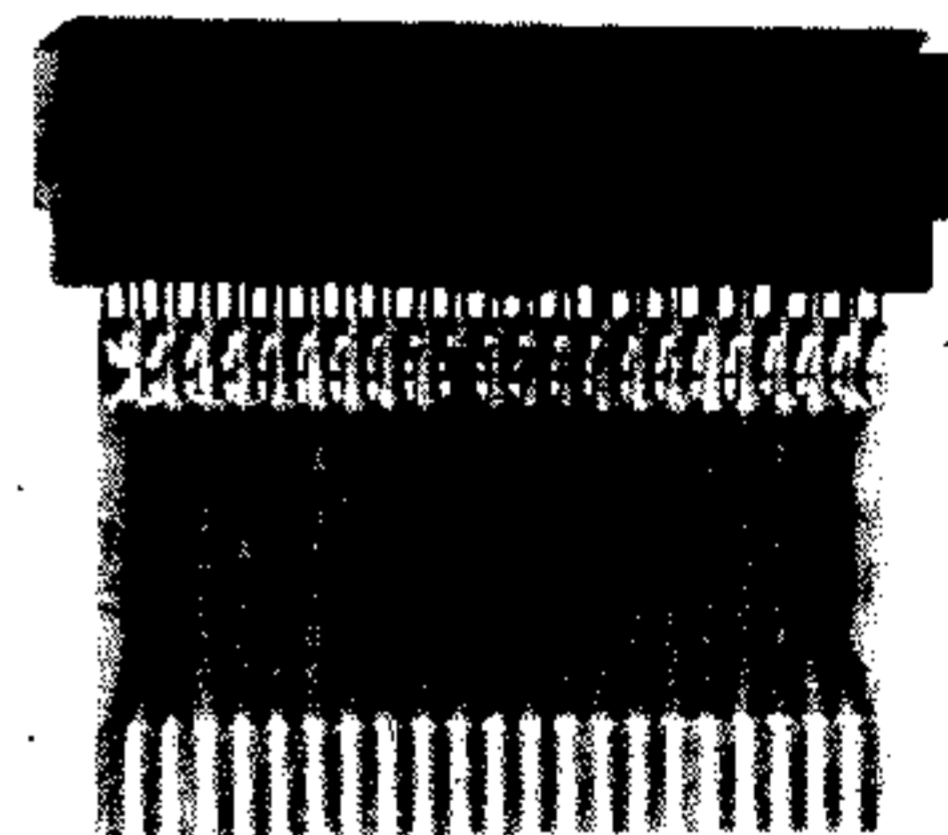

**38164 Load Interrupt Switch**

**\$11.95**

AVAILABLE FROM YOUR FRIENDS AT



*We gladly accept mail orders!*

P.O. Box 6578  
South Bend, IN 46660

**Questions? Call 219/259-7051**

SHIPPING CHARGES	
ORDER AMOUNT	CHARGE
less than \$20.00	\$3.75
\$20.00-\$39.99	4.75
\$40.00-\$74.99	5.75
\$75.00-\$149.99	6.75
\$150.00-\$299.99	7.75
\$300 & up	8.75



**NO EXTRA FEE FOR CHARGES**



*We verify charge card addresses.*

**ORDER TOLL FREE 1-800-348-2778**

## LOGO AND FORTH—

(Continued from Page 14)

price is \$200-\$250 for a used card and software), it may still assert itself in the TI community.

**Logo**— Few may be aware of the fact that Texas Instruments developed and marketed the first licensed release of true Logo for any home computer. Developed by Seymour Papert at Massachusetts Institute of Technology in the 1960s, Logo was to be an education-oriented language specifically for elementary-age children. By using simple English-like commands, the child is able to learn programming concepts through "turtle graphics" (so-called because the original implementation of the language was to control the movement of a mechanical object on wheels that looked like a turtle). With the TI version of Logo, the turtle is a triangular object on the screen that is manipulated to draw graphics using commands such as "RIGHT," "FORWARD" and "BACK."

The language, as executed on the 99/4A, certainly encompasses more than just graphics. By combining the resident "primitive" commands with recursion, skilled Logo programmers can write programs to reverse or alphabetize a list, "write" poetry, play games or solve complex mathematical problems, particularly geometry. Logo II, an enhanced version of the original TI-Logo, also allows the use of sprites and sound. But, just as Papert envisioned, Logo is designed for children so that they may learn to manipulate the computer and its graphics through simple commands, gaining confidence with the machine as they go along. You'll never write a database with Logo, but your 8-year-old may learn a great deal.

**Forth**—As a parting gift to the 99/4A community, Texas Instruments entered its version of Forth into the public domain in 1984. It was a

welcome and valuable gift. Just as in other computer communities, TI Forth has gained many converts, adamant in their belief that it is the ultimate language, combining the power and control of assembly language, with the simplicity of BASIC and the structure of Pascal. In reality, it falls short in all three claims, but Forth does combine some of the best of the other languages.

Developed by Charles Moore in the early 1970s to control the telescopes at Kitt Peak National Observatory in Arizona, the language was envisioned by its author as vaulting computer science from its "third generation" (the IBM 1130 he worked on) to a new, fourth generation. As the almost apocryphal tale recalls, the IBM mainframe computer would only accept five-letter identifiers, so "fourth" became "forth." Once developed, Moore did the unthinkable. He gave

(Please turn to Page 18)

## TI-994A



## IBM-PC?

## PEP!

### The problem

You have a 99/4A. You've had it for some time, and there is a lot of very valuable data stored on its diskettes.

You've also just acquired an IBM PC.

You want to transfer your data to the PC. As soon as possible, and as painlessly as possible.

### The solution

You need **PEP**.

**PEP** is a simple, inexpensive, universal technique for reliably and easily transferring data from your 99/4A (or almost any computer) to an IBM-PC. While virtually any application is running on the transmitting computer.

**PEP** stands for "Printer Emulation Package." Briefly, **PEP** is an advanced software product which will make your IBM-PC look like a printer to whatever computer is attached to it.

So, if you can print it, you can move it to your PC. It's that easy!

### Available now!

Good news — **PEP** is available right now. And it's deceptively inexpensive: \$59.95 in U.S. funds (\$79.95 Canadian), plus \$5.00 S&H. WRITE or PHONE for our free brochure!

**PEP** is a product of **INTELPRO** (514) 656-8798  
5825 Baillargeon St.      Brossard, Quebec, Canada      J4Z 1T1



# NEW FROM TEX-COMP

## AT LAST—A COMPLETE PRINT SHOP PACKAGE FOR THE TI-99/4A

Now create your own newsletters, advertisements, signs and greeting cards with this new package.

**INCREDIBLE NEW FONTS**  
 TINY LARGE WEIRD *SLANTED*

**FOR ALL OCCASIONS**

CLIPART AND PICTURES TOO!!!

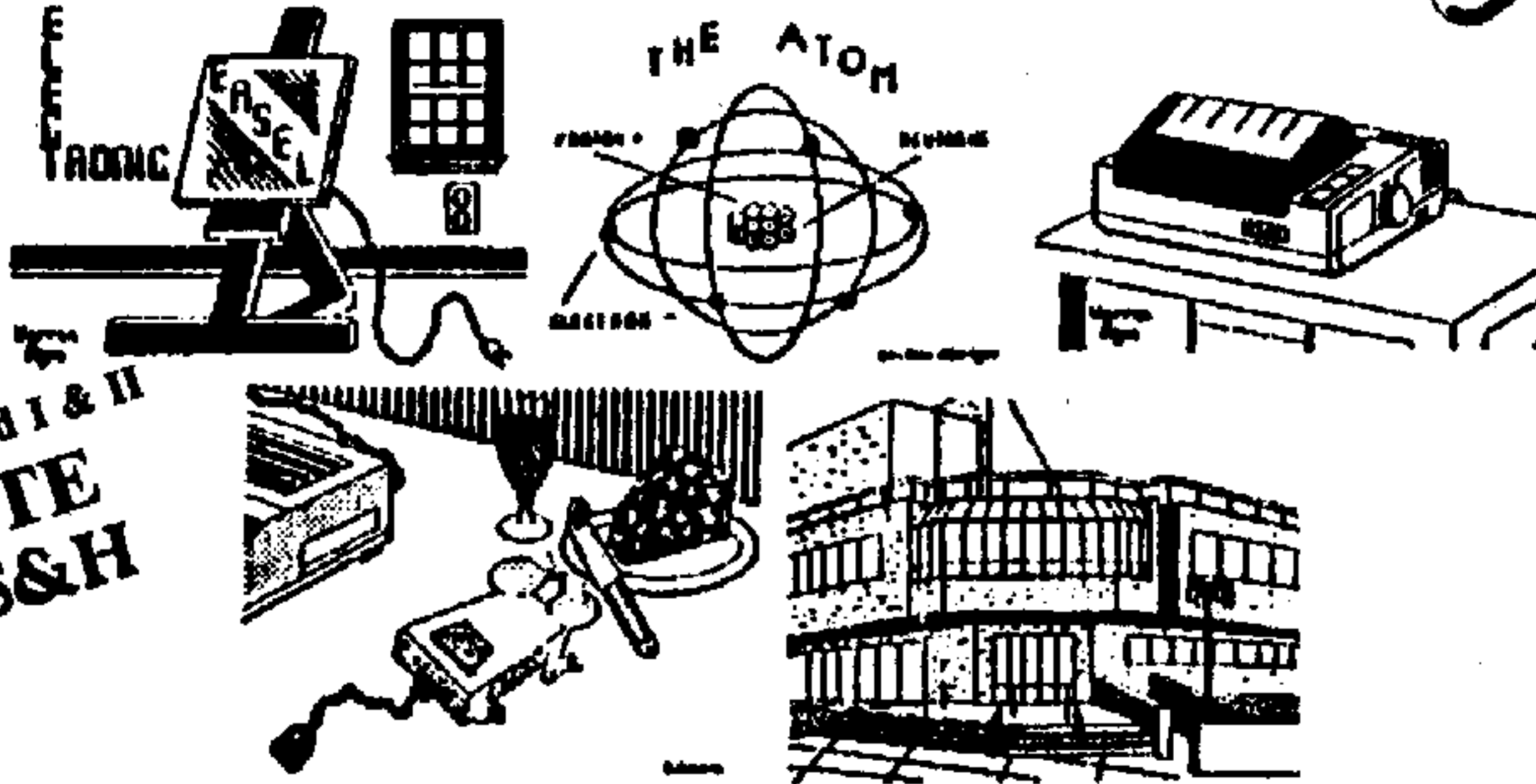

GRAPHX & Asgard I & II  
**COMPLETE**  
 \$47.95 + S&H

### PACKAGE INCLUDES GRAPHX + 2 COMPANION DISKS

Tex-Comp has gone all the way to Australia to directly import the latest extended basic version of GraphX and has combined it in a user-friendly package with 2 outstanding companion disks from Asgard, which are filled with 24 sets of fancy typestyles (fonts) and a huge collection of clip art pictures which can be printed out to make labels, illustrations, letterheads, etc. The companion disks contain a total of 14 clip art files with each file containing an assortment of different pictures.

By using GraphX together with these 2 companion disks, you'll have the ability, not only to create your own graphics, but also an outstanding collection of ready-to-use illustrations & typestyles. Requires 32K, disk drive, joystick and Epson or Star compatible printer.



VISA and MASTERCARD  
 HOLDERS CALL DIRECT.  
 (818) 366-6631

SEND ORDER AND MAKE CHECKS PAYABLE TO

**TEXCOMP™**

P.O. BOX 32064 - GRANADA HILLS, CA 91344

Texas Instruments



AUTHORIZED DEALER

add 3% for credit card orders

**24 Hour Order Line**

TERMS: All prices F.O.B. Los Angeles. For fastest service use cashiers check or money order. Add 3% shipping and handling (\$3.00 minimum). East of Mississippi 4 1/2%. (Free shipping on all software orders over \$100.00). Prices and availability subject to change without notice. We reserve the right to limit quantities.

NOTE: Payment in full must accompany all orders. Credit-Card, Company Check or Money Order for immediate shipment. Personal checks require up to 4 weeks to clear. California orders add 6 1/2% sales tax.

"The Leader of the Pack!"

SEND \$2.00 FOR NEW 1986 CATALOG WHICH INCLUDES A \$5.00 SAVINGS CERTIFICATE.

## The sysops of CompuServe's TI Forum

Barry Traver of Philadelphia says he is self-taught with no computer background.

"I don't know how things are supposed to be done, so I think up new ways," he says, comparing himself in this regard to Jim Peterson of Tigercub Software.

Though he rates himself as "stronger in the creative aspects but weaker in the technical ones" in regard to computing, he nonetheless operates a TI-related company, Genial Computerware (835 Green Valley Dr., Philadelphia, PA 19128, 215/483-1379). Current product of this cottage industry is the TRAVeLER, a TI "magazine-on-disk" (subscriptions \$30 per year). His TI articles have also appeared in other publications.

Traver was named chair of the Forum's Expert Member Board before he became a sysop. He was also founder and first president of the Philadelphia Users Group.

On the Forum, he says he works especially with the data libraries and Extended BASIC programming. The Forum's data libraries make new programming techniques, special programs and new ideas available to users, and Traver has worked to make them accessible even to the novice.

He holds a BA in math and an MA in English from the State University of New York at Albany, and theological degrees from Westminster Theological Seminary.

He has taught introductory computer courses at Jewish, Roman Catholic and Protestant educational institutions and is involved in home schooling his son.

In addition to himself, his wife (also a teacher) and son, the Traver household includes three cats, one a plain alley cat and two half Burmese, half Korat (a rare Thai breed).

**Access CompuServe  
At the prompt type  
GO TINEWS**

## PILOT—

(Continued from Page 16)

the language away. While Klidall was making millions off CP/M and Gates was buying northern California with proceeds from Microsoft BASIC, Charles Moore made his language public-domain. The language has gradually found a strong following and the Forth Interest Group has promoted the language, making it available cheaply for virtually all home computers. The TI version closely follows the FIG "standard."

Forth is a "mid-level" language. It is easier to learn than assembly and runs much faster than BASIC. It is built along the theory of "words." The programmer actually writes his programming language as he programs. By giving unique names of his choosing to combinations of procedures, and then combining the new words as the definitions for more complex procedures, the programmer ends up with a single word which, when executed, runs the entire application. Also, Forth is ideally suited for small-memory computers like the TI since its operating system, compiler and interpreter and editor all fit in 8 kilobytes of space. Because of its development outside the stereotyped corporate software world, Forth programmers have almost a "cultist" attraction and loyalty to the language.

If you are interested in powerful program applications and defining the procedures under your own structure with few rules, Forth may be for you.

**Pilot**—Developed to almost a full commercial product, Pilot from Texas Instruments was never released. It was to require the Pascal peripheral card to run in any case, which, because of its high cost, would have severely limited its potential audience.

Pilot (Programmed Inquiry, Learning, or Teaching) was developed by John Starkweather and colleagues at the University of California, San Francisco, about 1968. It was written to introduce children to computers. It has become more useful to teachers with little programming experience in writing "computer-aided instruction"

(CAI) programs. The standard version of Pilot has only 15 commands, mostly dealing with text display, data entry, and comparing input to expected acceptable answers. The commands themselves are simply 1 or 2 letter statements followed by a colon. Commands are easy to remember. For example:

T: Name a large Texas city?

is all that is required to place the "T"ext statement "Name a large Texas city?" on the screen.

To then accept an answer, one would use the following statement:

A: A\$

to "A"cept the answer string A\$ (this would be the same as "INPUT A\$" in BASIC).

## Languages available

Extended BASIC, assembly language and Logo are available from dealers and distributors of TI products. Some P-code cards may be available, but the cards are usually resale items.

TI-Forth is available from sources including MICROpendium and TI software dealers and distributors. Another version of Forth, Wycove Forth (see September 1984 MICROpendium) is available from Wycove Systems Ltd., P.O. Box 499, Dartmouth, Nova Scotia, Canada B2Y 3YB.

Pilot 99 is available from Thomas Weithofer, 1000 Harbury Dr., Cincinnati OH 45224. The c99 language is available from Clint Pulley, 38 Townsend Ave., Burlington, Ontario, Canada L7T 1Y6.

The true power of Pilot is lodged in the "M"atch command. In our running example, suppose we are looking for either Dallas, Houston, Fort Worth, or San Antonio, any one as the correct answer. By following the accept command with:

"M: Dallas Houston Fort Worth San Antonio" the program will accept any of the cities "M"atched as correct, easily permitting several possible choices. The simplicity of the commands in Pilot make it, quite possibly, the easiest computer language to learn. But with ease of use and "high-level"

(Please turn to Page 20)



Texas Instruments TI-99/4A - COMPUTERS, COMPONENTS AND SOFTWARE

# TEX+COMP™

America's Number One TI computer retailer

## Presents

# Super Savings

### On Essential Software Packages for the Texas Instruments Home Computer

As part of its program of long-term support for the TI-99/4A user, Tex-Comp has purchased truck-load quantities of original TI Software that is essential to the serious & dedicated user.

In turn, Tex-Comp is passing the savings on to **YOU!**

All TI Software in this advertisement is brand new, original TI Product in factory-sealed packages and is sold with a full Texas Instruments warranty, which TI has publicly committed to.

Now is the time to buy **Key Software** at a fraction of its original cost.

## There may never be a better time than now to buy

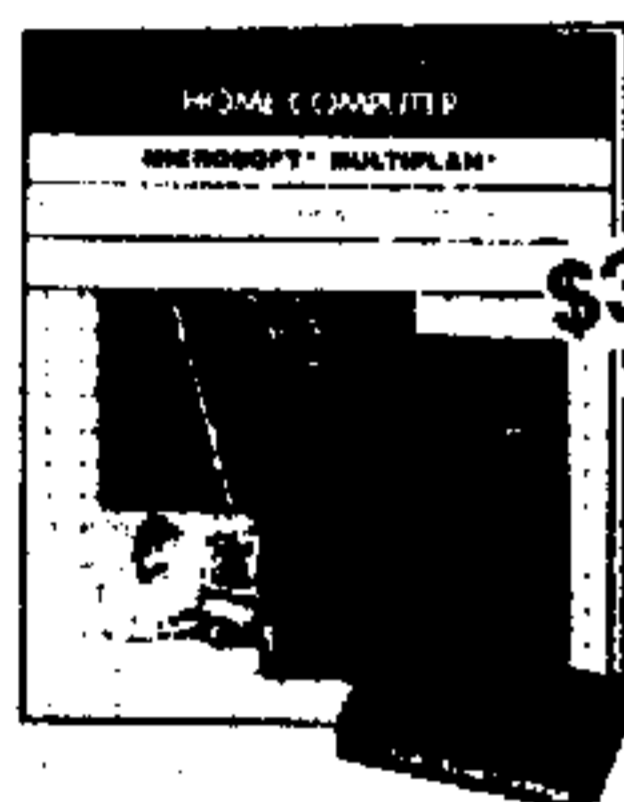

**\$38.95**  
+ S&H

### TI Multi-Plan

Electronic Worksheet with many advanced features and built-in ease of use. Requires disk drive and controller, and 32K memory Expansion Unit. Printer and RS-232 Interface recommended. Cartridge and Disk.



**\$38.95**  
+ S&H

### TI Writer

This is a professional word processing system for the TI-99/4A. Provides the features and ease of use found in office systems. Requires disk drive, 32K Memory and Printer. Module and Disk.

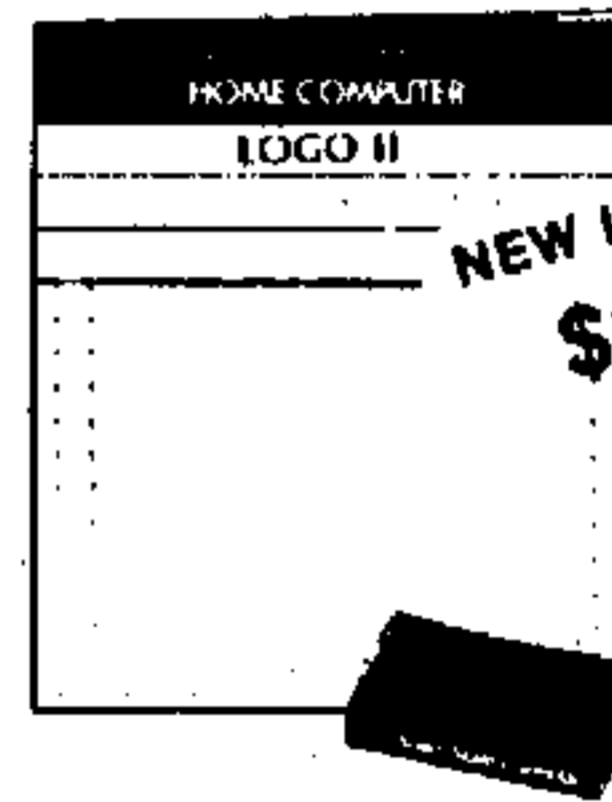

**NEW LOW PRICE!**  
**\$19.95**  
+ S&H

### Logo II

In use by educators throughout the country. Requires cassette or disk based system and 32K memory expansion.

**SPECIAL!! Multi-Plan & TI Writer \$69.95 + S&H All 3 of the above programs \$84.95 + S&H**



**\$19.95**  
+ S&H

### Editor/Assembler

This is the complete version with manual, module, program disk and the disk version of Tombstone City as an example of assembly language programming. 32k and disk drive are required. This package will allow you to program the 99/4A in TMS 9900 Assembly Language and gives you access to all system features. Provides the fastest speed possible from the 16-bit processor!

#### Special Bonus

**with Editor/Assembler Purchase**  
Order with "Introduction to Assembly Language for the TI Home Computer" by Ralph Molesworth for only \$4.95 + S&H (a \$9 savings)

Get the Widget (Navarre's Cartridge Expander Board) and the Editor/Assembler for only \$38.95 (a \$5 savings)

Order all 3 Editor/Assembler, Molesworth's book and the Widget for only \$43.95 + S&H (Save \$14)



**\$49.95**  
+ S&H

### Original TI-Extended Basic Still the BEST for Less!

A powerful, high-level programming language that expands the capability of your TI-99/4A Home Computer. Includes TI Extended BASIC module (36K bytes of preprogrammed memory) and Owner's reference manual.

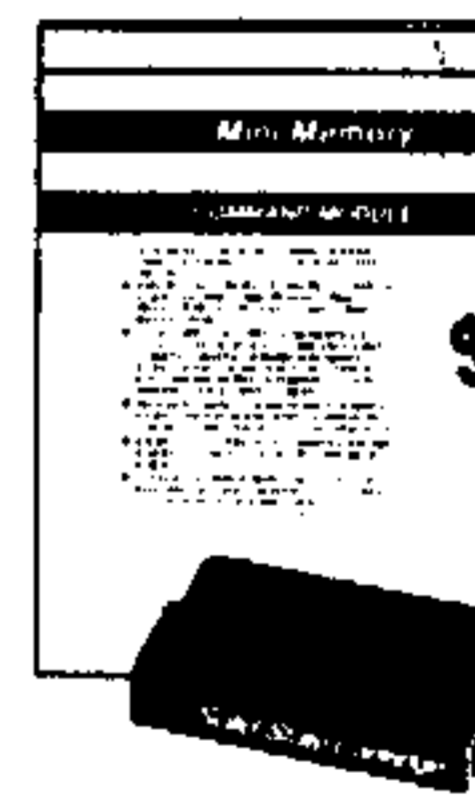

**\$38.95**  
+ S&H

### Mini-Memory

This software cartridge adds memory to your system. Totals 14K of memory (6K of GROM, 4K of ROM, 4K of RAM). Mini Memory includes a built-in battery, permitting programs and data stored in RAM to be retained even if module is removed from console.

**BONUS: FREE Mini-Writer I word processor (a \$19.95 value) with Mini-Memory Purchase.**

		VISA and MASTERCARD HOLDERS CALL DIRECT	SEND ORDER AND MAKE CHECKS PAYABLE TO	Texas Instruments
add 3% for credit card orders		<b>(818) 366-6631</b>	<b>TEX+COMP™</b>	
TERMS: All prices FOB Los Angeles. For fastest service use customer check or money order. Add 3% shipping and handling (\$3.00 minimum). East of Mississippi 4 1/2% (Free shipping on all software orders over \$100.00). Prices and availability subject to change without notice. We reserve the right to limit quantities.		NOTE: Payment in full must accompany all orders. Credit Card (charge, check or money order for immediate shipment). Personal checks require up to 4 weeks to clear. California orders add 8 1/4% sales tax.		

SEND \$2.00 FOR NEW 1986 CATALOG WHICH INCLUDES A \$5.00 SAVINGS CERTIFICATE

c99—

(Continued from Page 18)

interface, come extreme limitations in capability.

Realizing its potential usefulness to 99/4A users, Thomas Weithofer, a computer science student in Cincinnati, Ohio, went TI one better. Rather than writing Pilot as a Pascal implementation, Weithofer used Forth. His version will run in either the Extended BASIC, Editor/Assembler or Mini-Memory environments (memory expansion and a disk-drive are required). Weithofer's Pilot 99 adds many statements which utilize the features of the 99/4A, including sprites, bit-map graphics, sound and file handling. Pilot 99 maintains the simple commands of vintage Pilot, but has enhancements that make it a more useful language, quite capable of relatively complex programming. The potential usefulness of Pilot 99 has only been hinted at.

c99—The latest addition to the 99/4A programming library is a version of the "C" programming language called "c99." Why the lower case "c"? To allow small memory-capacity home computers to run the language "C," developed at Bell

Laboratories to support its UNIX systems. Ron Cain wrote "small c" and published the source code in Dr. Dobb's Journal (May, 1980). It was rapidly adopted as a legitimate subset of the "C" language and has been thoroughly supported since. Clint Pulley, working with a Z-80 version of small-c, wrote and transported a version to his 99/4A. He named it "c99" (thus, the small c).

The c99 system, though in its first version, appears to offer a great deal. The language is syntactically identical to standard C and its compiler produces assembler source code rather than machine code, making the addition of other assembler routines for TI-specific functions quite feasible.

How does it work? You have to first get a book on the C language (there are at least five very good ones available); like the Forth documentation, c99 documentation tells you how to run the system but not how to write programs. Then, using the editor of Editor/Assembler or TI-Writer, you write your program using C syntax. For example, you might write:

```
/* This program prints "hello, world"
*/ main()
{ printf("hello, world\n");
}
```

The BASIC equivalent would be:

```
10 REM This program prints "hello, world"
```

```
20 PRINT "hello, world"
```

Comments in C are enclosed with the /\* and \*/ to show the beginning and the end of the comment areas. The main routine that a program will perform starts with the word "main"; any values or arguments that are being given to the program at the outset are enclosed in parentheses. The beginning and end of a group of statements are marked with braces.

Once your program is written and saved to disk, you run the c99 compiler. It will ask you your source code filename and the filename you wish to write the compiled code (actually translated from C to assembly language), and then away it goes. It executes very rapidly. Once the compiled (or translated) code is written to disk (assuming there are no errors detected by the c99 compiler), you simply run the assembler function of your Editor/Assembler package on the compiled code. When finished assembling, again assuming no errors in the assembly process, your output file is ready-to-run object code. It is runnable through Option 3 of the E/A module. Admittedly, this is a round-about way to generate machine code, but, for one who has a total mental block for assembly language programming, c99 promises to be easier to learn, faster to program, has a standard syntax independent of hardware specifics (i.e. if you learn C on the TI you can write C on any other computer), and produces portable programs (at least the C code itself).

Having been just released, it is too soon to judge the impact c99 will have on 99/4A programmers.

## Starcross corrected

January's review of Infocom's Starcross stated that the program will run with the Mini-Memory, TI-Writer and Editor/Assembler cartridges. The program will not run with TI-Writer. However, in addition to MMM and E/A, it will also run out of Extended BASIC.

## EXTENDED BUSINESS GRAPHS!

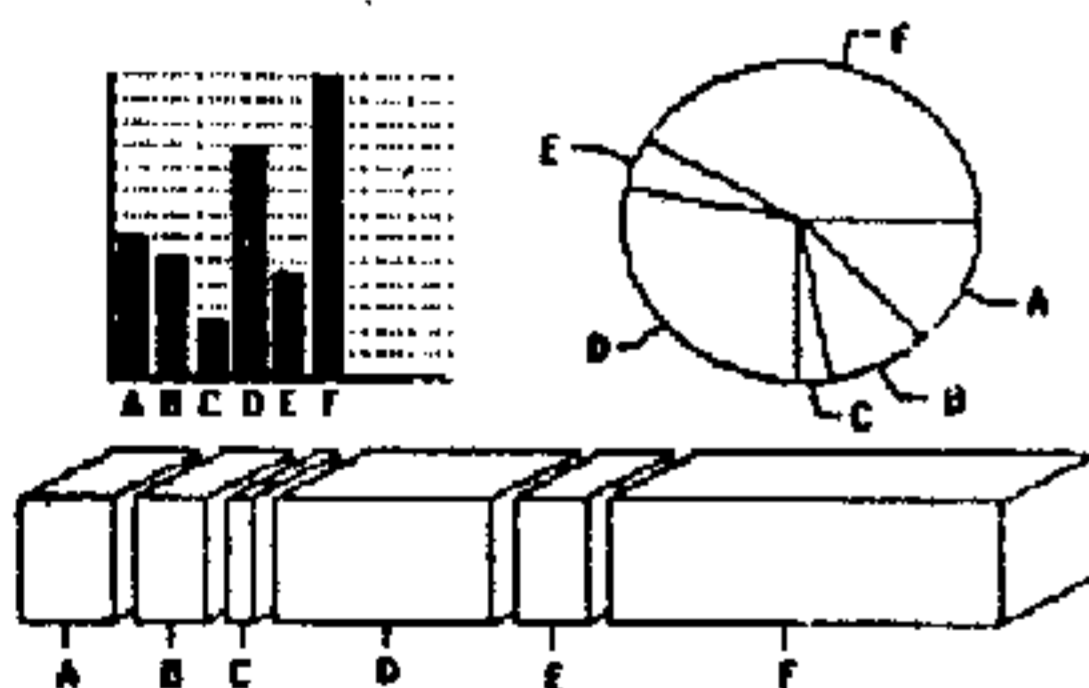

The latest business and chart utility available for the TI-99/4a!! Allows users to input and graph any set of data or statistics. Features BARGRAPHS, PIE CHARTS, LINEAR GRAPHS, and THREE DIMENSIONAL CHARTS all in one package! Graphs can be saved to disk for later use and printed with any dot matrix printer (Epson, Gemini, TI, Pro-Writer, Axiom, etc) No need to buy extra plotter programs!! Great for business, home or school!!! Requires Ext. Basic, 32k, and one disk drive. \$24.95 POSTPAID.

**GREAT LAKES SOFTWARE**  
804 E. Grand River Avenue  
Howell, MI 48843

WRITE FOR FREE CATALOG!

## JSTI SOFTWARE

presents

## TEACHER'S AIDE

(See our classified ad for details)



# NEW!

## THREE FROM ASGARD...

### Artist Companion

Now, from the makers of the highly acclaimed GRAPHX Companion (see review in the Sept. '85 issue of MICROpendium) a companion product for the latest advance in 99/4A graphics, TI-Artist. All others aside, only our companion features art work from some of the best artists in the TI-99/4A world - Warren Agee, Chris Bobbitt, and many more fine craftsmen. Only our companion features not only the best art for GRAPHX (including the winner of the MICROpendium graphics contest) but also a collection of all new art work designed specifically for TI-Artist. Finally, our companion is also the least expensive available, only \$7.00 for a two-disk package. Requires TI-Artist Version 2.0

**\$7.00**

### Recipe Writer

Now available, the ultimate kitchen aid for the TI-99/4A! This useful utility for home-maker and chef alike is written entirely in the Forth language. Not only is it blindingly fast, it is also easy-to-use with one-touch menus and full prompts in English, not computer-ese. Its many powerful functions allow easy recipe entry and editing, printout and organization. Included are options for easily converting recipes to different serving sizes, and for printing stored recipes on index cards as well as regular paper. Ideal for maintaining a collection of recipes without messy, unorganized pen and paper! Requires Extended BASIC, 32K and a disk drive.

**\$12.00**

### Quick Dialer

At last, an easy-to-use automatic telephone dialing program designed for use with popular terminal emulator programs such as FAST-TERM and P-TERM! Store up to 100 names and numbers in a single directory file for dialing at the touch of a single key. Features automatic re-dialing if a number is busy, full name and number editing options as well as complete print and display functions. The package includes a pre-written version for use with FAST-TERM, an easily modified generic version for other TE programs, and extensive documentation. Great for use with Compuserve, Source, and local BBS systems. Requires Extended BASIC, 32K, disk and a modem.

**\$10.00**

©1986 by Asgard Software

**Asgard Software POB 10306 Rockville, MD 20850**

# A quiet cooling fan for the P-box

By **DAVID RENKENBERGER**

When Texas Instruments released its unique Peripheral Expansion System for its home computer it received mixed reactions. Those who liked it were quick to praise its rugged construction and provisions for seven cards. Those who did not criticized it because of its bulk and its lack of power (so we thought) to run two disk drives. The features that almost all of us found annoying were the large flat cable and the very noisy cooling fan.

I know of no solution to the flat cable, but my system is presently equipped with a cooling fan that improves the noise situation while maintaining adequate cooling for the system.

Before I go further I would like to give credit where it is due. I was one of those who recognized that my system was noisy but had neither the knowledge nor the initiative to do anything about it. I had grown used to the system through months of use and seldom ever worried about how much noise it made.

This was not the case with another member of our users group, however. When Jerry Clasby (a mechanical engineer by trade) expanded his system, he found the noisy fan unbearable and worked with the system until he found an adequate fix. After hearing his system run, I made the same modifications to mine. Both our systems have been running with these modifications for several months now with no problems.

If you look at your expansion box you will find that the fan is at the rear of the left side compartment inside the box and that the air flow is directed out the back. You will also notice that the fan gets its power from the line side of the transformer, so changing components is not likely to affect the transformer or the power supply. The major heat producing components in the system are confined in the same compartment with the fan, the transformer probably producing the majority of the heat. You will also notice that the stock fan is mounted flush against the back wall with four studs arranged in a standard pattern for three-inch cooling fans (4-inch center to center diagonally).

After trying several modifications to the stock fan, Jerry finally replaced the unit with one that he purchased from an electronics discount house. This is the one that we have settled on using. The fan is a Sprite Model SU2C5 and it should be available at any of the larger electronics houses. Prices will vary but we were able to buy ours for about \$16. The only additional hardware required are two quick disconnect terminals from Radio Shack #64-3049 terminal pack (99 cents).

If you really want to get fancy, you can make a gasket to isolate the fan from the back wall by cutting up one of your

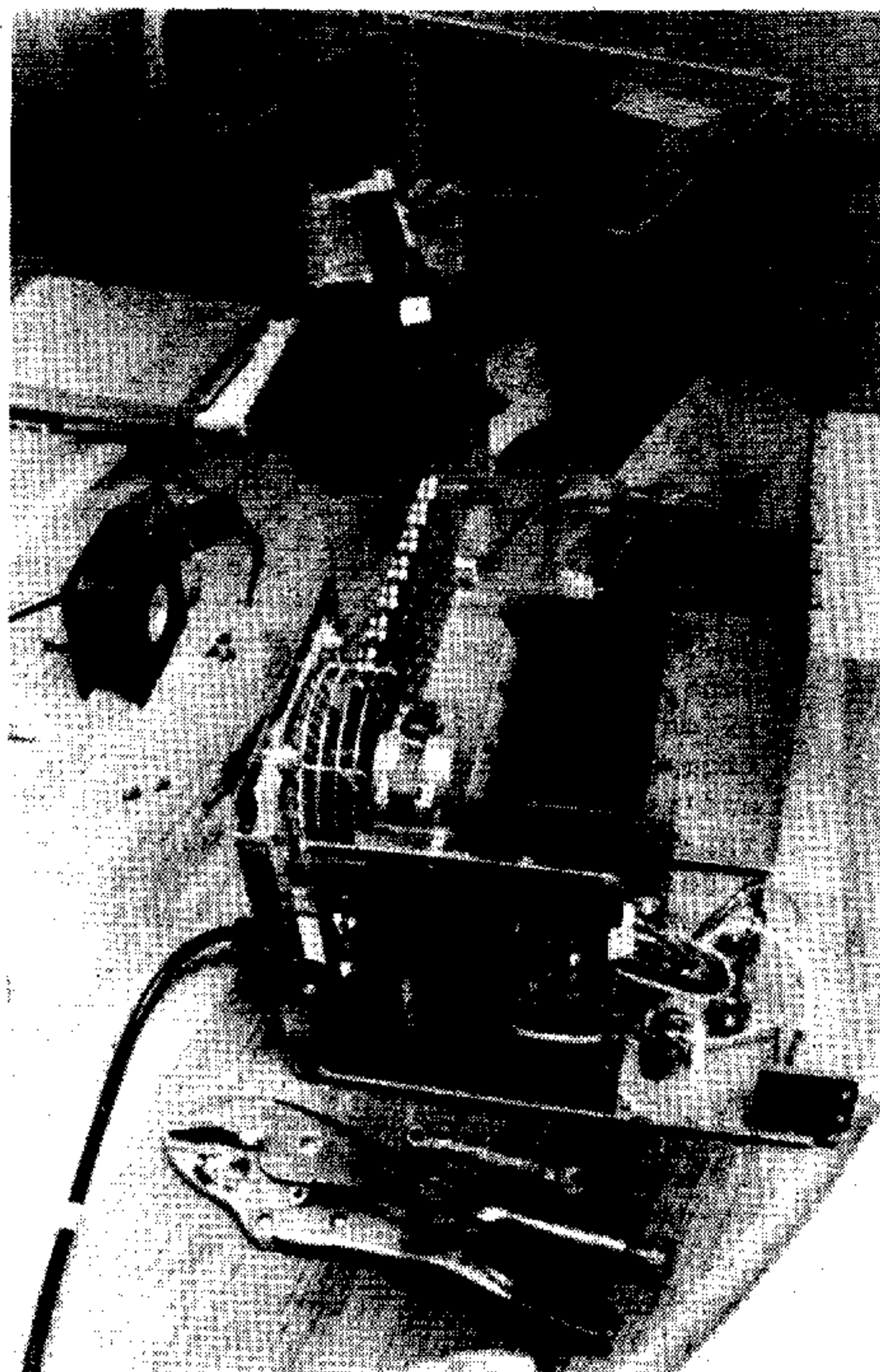

The shell of the Peripheral Expansion Box has been removed from its base, revealing the power supply and fan. The shell is attached to the base with about a dozen screws.

kid's bike inner tubes but the jury is still out on this one. Cutting out the back panel would probably help reduce some more of the noise and pick up some air flow as well, but I doubt if one of TI's exchange centers would give you credit for a butchered box if service is ever required.

Before you do anything to your system, you should perform the following test. Turn on the unaltered system and let it run for at least an hour to let the temperature stabilize. Next, locate a thermometer and record the room temperature, then place the same thermometer in the discharge air from your system's cooling fan, recording that temperature also. Write these figures down because you will be repeating this test with the modified system. My stock system gave a temperature rise of 5 to 6 degrees F while the modified system had a 7 degree rise. This proves to me that the new fan is doing an adequate job of cooling. If your figures show that the your modified system is running very much hotter than the stock system, it would be wise to change back to the stock fan.

(Please turn to Page 23)



## FAN—

**(Continued from Page 22)**

To install the new fan, turn off the expansion box and everything connected to it. After the recommended two- or three-minute wait, remove all connecting cables and take the box to where you will be doing the work. Be sure to take the usual precautions to prevent static electric discharges. Now remove the top cover. Next, remove the disk drive(s) and then very carefully remove all the cards.

The outer case of the box is held in place by several phillips head screws on the sides, back, and bottom of the unit. After the screws are removed, the inner panels will slide out the back of the unit and the fan's position will be evident.

After locating the fan, remove the four ESNA lock nuts and washers that hold it in place (it may be necessary to loosen the two screws that hold the vertical circuit board in place so this board can be slid out of the way giving access to one of the nuts). A firm pull will be required to separate the quick connect terminals so the old fan can be removed (it may be necessary to grip both ends of the connectors with pliers to do this).

Next, crimp new terminals to the new fan and install it so the air flow is directed out of the box. Secure the fan to the box with the four nuts and plug the box in. Turn it on and verify that the air-flow is directed out the back of the box.

Reassemble the expansion box in reverse order of disassembly and you will have a quiet expansion system. The whole procedure should not take you more than 45 minutes. Be sure to rerun the heat test for your own peace of mind.

## Disk Surgeon 99

The authors of Disk Surgeon 99 have cancelled their marketing agreement with Amerisoft, which formerly marketed the program.

The program is available from Utilitee Software, P.O. Box 7275, Dearborn MI 48121.

**DISK + AID**

This is the most advanced, user friendly disk repair utility you can own. This incredible program, as reviewed in April MICROpendium, "...IS IN A CLASS BY ITSELF." With over 30 single keystroke operations teamed together with a manual, which is an entire tutorial on the TI disk operating system, you have a package that has yet to be matched by any program available. Sector zero and directory sector mapping is the most advanced of any program available today. The screen format is considered by many to be the best ever designed. Hard copy formatting is unmatched by any program. DISK + AID is an invaluable addition to your utility software collection and is the best you can own for file and data recovery. XB, MM, EA, 32K, DISK REQUIRED. \$20.00

**GRAPHX**

Believed by many to be the most advanced graphics program ever written for the TI-99/4A home computer. GRAPHX has features not found on any other graphics program available for the TI. Many of its features can only be found in professional graphics systems. Animation, full color, sophisticated circle drawing, 4 printout formats, plus much more can now be at your fingertips. Please specify XB, EA or MM when ordering GRAPHX. XB, MM, EA, 32K, DISK, JOYSTICK \$37.50

Also available by legal agreement with ASGARD SOFTWARE, GRAPHX COMPANION I and II. This incredible collection of character fonts and pictures is a one of a kind for GRAPHX. You shouldn't be without it. This incredible package can be yours for just \$6.00 each if you order them with GRAPHX or have already purchased GRAPHX from THOMSON SOFTWARE. If ordered separately they are still a LOW \$8.00 each plus \$1.50 S & H. Order yours today. Thousands sold already!

**TURBO DATAMAN**

This true database is by far the fastest and most powerful database today. You can link screens together for complex applications or build a simple address file. You can use it to keep accounting books for a home or business. Powerful math computational capabilities on your data as you enter it is a feature unmatched by any database program. With this feature, you can have spreadsheet capabilities in your databases. Full field editing is available to keep your information perfect as you enter it. Customize your data entry screens using a combination of graphics and text. Forms report generator for your custom reports. Written in XB and assembly for incredible speed. Up to 30 fields per record and 256 characters per record. XB, 32K, DISK \$30.00

**XB DETECTIVE**

This incredible XB programming utility is a one of a kind and a first for the TI-99/4A. Offering editing features never known to the XB programmer. List to screen or printer, in alphabetical order, all the variables in your program and find out what line numbers they're in.

Find variables that keep giving you program errors like "IMPROPERLY USED NAME." Find reserved words for easier debugging. Delete one line or a group of lines without having to continually press enter or list them. Find "GOTO'S", "GOSUB'S" and "SUB'S" to track program flow. Find where a file is opened, closed or deleted. Written entirely in assembly language, XB, 32K DISK \$18.00

The following software has had special price cuts for the months of February, March and April:

**MEMORY MANIPULATOR OLD PRICE \$20.00 NEW PRICE \$10.00 + \$1.50 S&H**

**CREDIT CARD DATA BASE OLD PRICE \$20.00 NEW PRICE \$8.00 + \$1.50 S&H**

**EASY BILL PAYING OLD PRICE \$20.00 NEW PRICE \$12.00 + \$1.50 S&H**

Please include \$1.50 S&H for each program ordered. Michigan residents add 4% sales tax. Personal checks, money orders or C.O.D. Dealer inquiries invited. Free catalog available.

**THOMSON SOFTWARE DAY PHONE 616-755-2943**

**1461 BEACH STREET**

**MUSKEGON, MI 49441-1099 AFTER 4PM 616-726-4602**

Texas Instruments TI-99/4A COMPUTERS, COMPONENTS AND SOFTWARE

# TEX+COMP™

America's Number One TI computer retailer



**\$1995**  
POSTPAID\*

## BACK+UP YOUR DISKS with "NIBBLER"™

**NIBBLER™** is the most powerful disk duplicator available for the TI-99/4A. Unlike the TI Disk Manager Module which cannot access the 32K memory expansion, this program reads as much as the memory can hold and then writes it to the new back-up disk. This means that disks can be duplicated in one to three passes. Saves wear and tear on your drives and with a one disk drive system, it saves wear and tear on you!

The **NIBBLER** copies most protected disks and is compatible with both TI and CorComp systems. Make your own back-ups in case of disk disaster. Full menu selection, auto format, and complete instructions on the disk in an easy to access "HELP" file. Exclusive feature allows copying of selected sectors only. Runs on Extended Basic, Editor/Assembler or Mini-Memory. For speed, convenience, security and accuracy . . . its **NIBBLER!**

Capabilities include autoformatting, bitmapping, and selective sector reading and copying!

THE ORIGINAL

**\$1995**  
POSTPAID\*

Inspect the innermost  
secrets of a  
TI-99/4A Disk



# The Explorer™

Disk Editor for the TI-99/4A

From StarSoft

**REPAIR, FIX AND EDIT!!**

The **EXPLORER™** is a powerful disk editor written in assembly language allowing the user to edit a disk by individual sectors rather than by filenames. Individual bytes within any sector of a disk may be displayed and edited.

Editing is handled through a full-screen editor that displays the contents of a sector on the screen and allows editing in both hexadecimal and ASCII character formats.

The Disk Editor may also be used to move data from one sector to another and to attempt to fix damaged disk directories and improperly closed files. Optionally, the contents of all sectors being viewed on the screen may be dumped to a printer, the disk drive, or any other standard peripheral.

Supplied on a single diskette, the **EXPLORER™** requires 32K memory expansion, one or more disk drives, and either TI Extended BASIC, Mini-Memory, or the Editor/Assembler cartridge.

**SPECIAL INTRODUCTORY OFFER:** With each copy of the **EXPLORER™**, you will also receive a free copy of Disk Manager 1000, a completely self-contained public domain disk manager program to replace the TI module.

**ALSO AVAILABLE:** "Hidden Powers of Disk Fixer," which will assist you in expanding the uses of the **EXPLORER™**. \$9.95 POSTPAID

The **EXPLORER** is a registered trademark of Tex-Comp. Any unauthorized use constitutes a violation of Tex-Comp's trademark rights.

SEND ORDER AND MAKE CHECKS PAYABLE TO:

**TEX+COMP™**

P.O. BOX 33064 - GRANADA HILLS, CA 91344

**NOTE:**  
Payment in full must accompany all orders. Credit Card, Company Check or Money Order for immediate shipment. Personal checks require up to 4 weeks to clear. California orders add 6 1/2% sales tax. When in the Los Angeles area visit our modern warehouse outlet store where you can purchase all TI items at our regular discount prices. Call for location & hours!



**24 HOUR ORDER LINE**  
VISA AND MASTERCARD HOLDERS CALL DIRECT:  
**(818) 366-6631**



All prices reflect a 3% discount for cash. Add 3% if paying by Credit Card.

\*CONTINENTAL US ONLY

**"The Leader of the Pack!"**

**SEND \$2.00 FOR NEW 1986 CATALOG WHICH INCLUDES A \$5.00 SAVINGS CERTIFICATE.**



# RAMdisk sells as kit or assembled

The Horizon RAMdisk, developed by Ron Gries, John Clulow and David Romer of Horizon Computer Limited, is a 104K card which can be inserted in the peripheral expansion box, according to the manufacturer.

Clulow said the cards will come in a kit form or an assembled form. He said users should contact the company as to date of availability.

According to the manufacturer, the 104K is expandable to 192K and the expansion is treated as a double-sided disk.

The RAMdisk uses low-power CMOS static RAM chips and is powered with a Nicad battery which charges while the computer is running. Because a battery is used, according to the manufacturer, the card is portable.

The manufacturer says that the Horizon RAMdisk acts exactly like a TI floppy disk drive. According to the manufacturer, DM-1000, Disk

Manager II, Millers Graphics' Explorer, TI-BASIC, TI Extended BASIC, TI-Forth, TI-Logo and assembly language run on it.

The card has DIP switch settings which allow CRU addressing from >1000 to >1700. The card comes with complete DSR source code, including a separate manual that details all DSR routines. Documentation is included which explains how users may add their own assembly language CALL routines to enhance BASIC. The card comes with development software, including a loader for any Editor/Assembler option 3 object files which will allow users to modify the DSR as desired. Schematic diagram is included.

According to the manufacturer, the card features CALL statements from TI-BASIC by which the drive number can be set, the maximum number of sectors can be set, write protection can be set, the CRU can be turned on for

direct DSR access and machine code can be executed from BASIC.

The card will be sold as a printed circuit board including manuals and software for \$50, according to Clulow. For this form, the user will have to purchase his own parts, Clulow said. He said single-sided parts sets are available from Bud Mills Services, 166 Dartmouth Dr., Toledo OH 43614, for \$72 and double-sided parts sets are available for \$105 from the same firm. The kits require some familiarity with electronic kit-building and can be constructed in one to two hours, Clulow said.

The other form for the RAMdisk is a fully-assembled, tested warranted unit. Price is \$180 single-sided, \$230 double-sided.

The Horizon RAMdisk may be ordered from Horizon Computer Limited, P.O. Box 554, Walbridge, OH 43465.

## Freeware update

### SUPER-MAIL

Super-Mail consists of three programs. A LOAD program serves as the main menu for selecting either telephone directory or mailing label functions. The Telephone/address program allows for adding to and outputting a telephone-type directory. Included is a sort routine as well as a recall function. The mailing label program prints single-column labels using 3 1/2-inch by 15/16-inch labels. It prints single labels or the entire contents of the telephone/address directory. Send \$5 to cover cost of postage, packaging and diskette to Henry J. Beck, 609 County Home Rd., Lexington, NC 27292.

### SIDE\*PRINT FOR MULTIPLAN

Side\*Print prints a Multiplan spreadsheet sideways. Included are a documentation file, sample spreadsheet and a disk cataloger/loader program. System requirements are Microsoft Multiplan, Extended BASIC, memory expansion, disk system and a printer that accepts the Star Micronics Gemini 10X protocols for downloading a character set. Send \$5, or send a disk, and self-addressed, stamped return mailer to: Jim Swedlow, 7301 Kirby Way, Stanton, CA 90680.

### CAPITAL CAPERS

Capital Capers is an educational program designed to help teach when to capitalize a word. All basic rules of capitalization are covered. Students have a choice of being tested only on the basis of a particular rule of capitalization or all rules simultaneously. In both cases, the student presses the space bar or joystick fire button to capitalize a letter that has a cursor over it. The "test" uses jokes and riddles. Students who correctly apply the rules of capitalization in the first part of the joke are rewarded with the punchline. Uses sound effects. Requires Extended BASIC and a cassette recorder. Send cassette and self-addressed, stamped return mailer, or \$7, to: Larry P. Morgan, 9 Fountain Lake Dr., Greenfield, IN 46140.

## Ryte Data has card from Mechatronics

Bruce Ryan of Ryte Data says his company has 128K/512K cards in from Mechatronic GmbH of Germany.

The card, which has 128K memory in two sections (expandable to 512K), 64K of RAM and another 64K GRAM, has been discussed in previous issues under the name GRAM-KARTE.

Ryan says that up to 300 of the cards are available for immediate delivery. He says the card allows running GPL programs from the card as well as the standard 9900 assembly code.

He says it is possible to change the CRU addresses to make the card compatible with other peripheral cards on the market. He has tested it with the Myarc card, he says.

A hexadecimal converter is built in and it is possible for a user to save GROM code or ROM code in program image to disk.

For further information, contact Ryte Data, 210 Mountain St., Haliburton, Ontario, Canada K0M 1S0.



# Other fans work, too

By JOHN KOLOEN

I tried David Renkenberger's recommendations for installing a quiet cooling fan and found them to be thoroughly adequate, though it took me a couple hours to complete the job. (Be aware that hardware modifications are made at the users risk.)

Following that disclaimer, we used a ETRI Model 126 LJ fan that was purchased for \$15 at a local electronics supply store. It has the same dimensions as the Sprite fan, which we could not purchase locally.

I found that the quick disconnect terminals recommended in the article were too small for the connectors used in my PEB. I peeled off a portion of the plastic housing from the connectors, plugged the ends into the connectors in the PEB and wrapped tape around the connection to insure they won't come apart.

The fan I used does not resemble the fan that originally came with the PEB. It takes up about half the space and is much, much quieter. To help you gauge the difference between the new fan and the original, step back two paces from your PEB while it is running. At this distance the low hum of the new fan I installed is barely audible.

While the article refers to "several" screws that must be removed from the PEB, I counted about a dozen. Every screw on each side, and all but the two screws used to attach the clips that lock the cover to the top of the PEB must be removed. Also, several screws on the bottom must be removed.

When the shell is pulled away from the PEB, the on/off button will fall off. Don't be concerned about this since it can easily be put back into place when you reassemble the PEB.

The biggest problem I encountered was in removing the original fan. The nuts are tight and there is little room to work. It is virtually a necessity to  
**(Please turn to Page 28)**

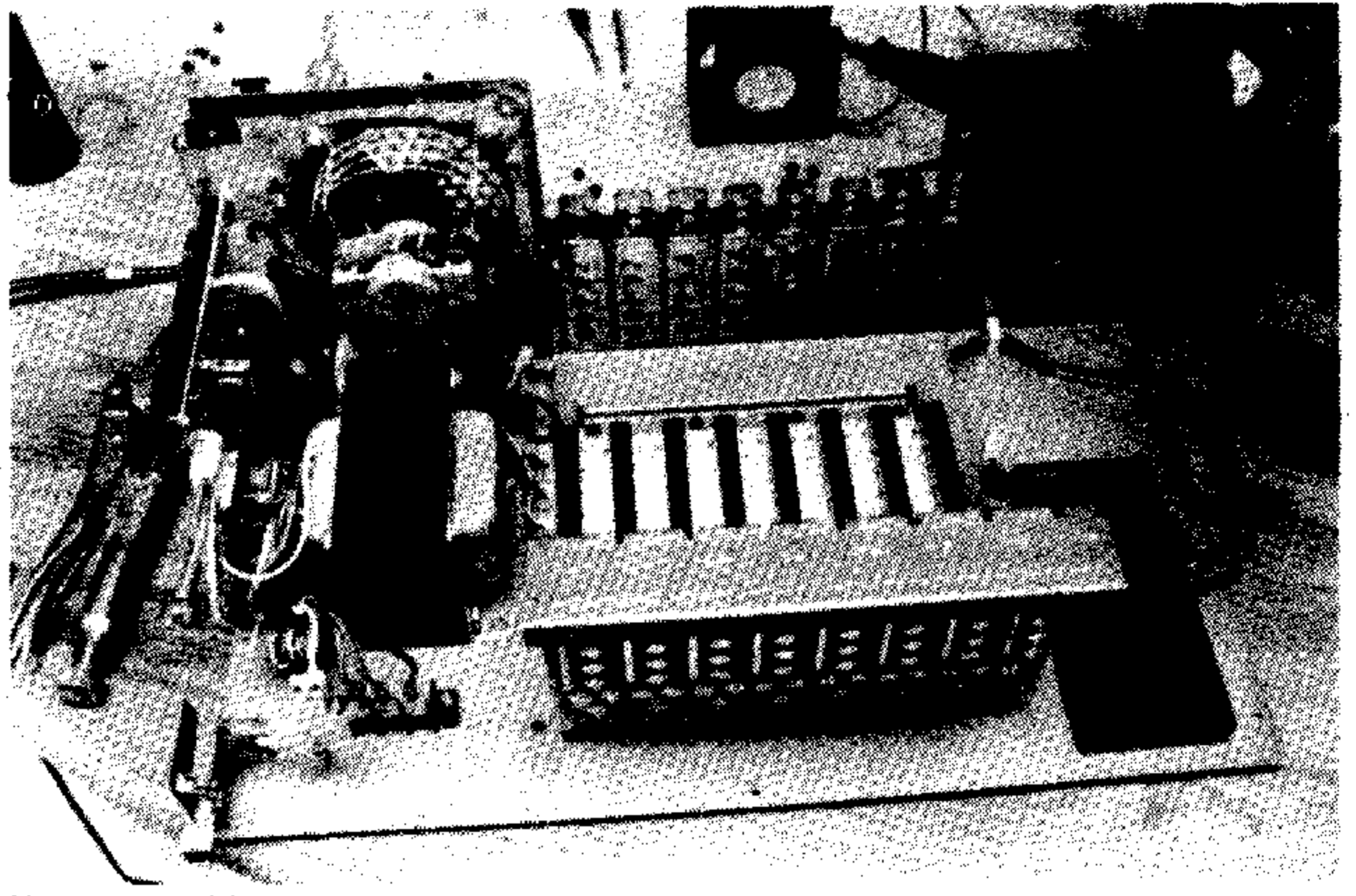

The exposed base of the PEB with original fan attached.

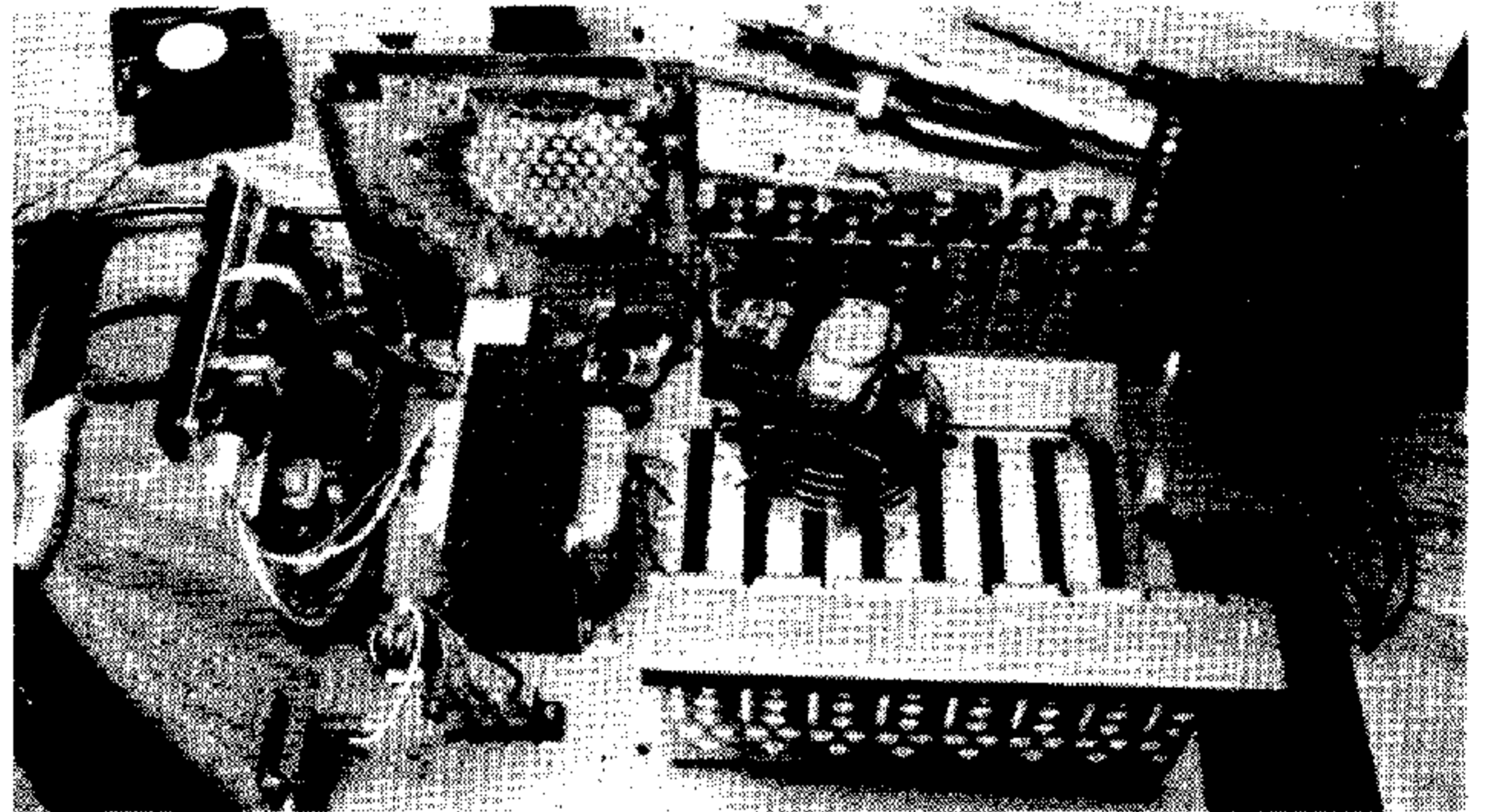

Fan is removed from mounting.

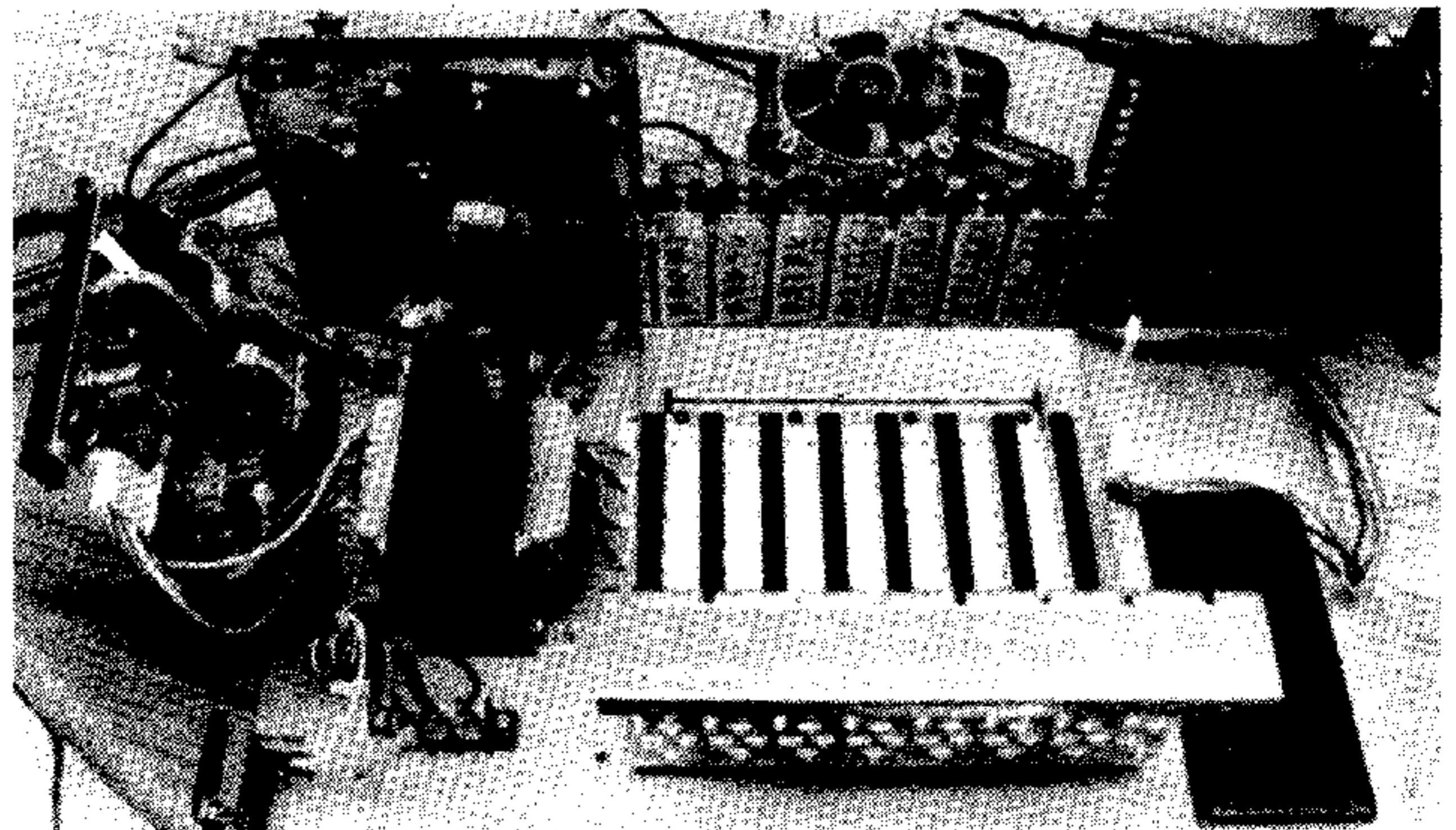

New fan is in place. Note that circuit board at left has been loosened from its mounts and pushed away from the fan assembly.





# Tex-Comp Proudly Presents BITMAC



## The Revolutionary New 99/4A Graphics Program from Vaughn Software

BITMAC is a comprehensive graphics program for the TI-99/4A computer which allows you to easily place "dots" on the screen in any position and in a choice of 16 colors. You can print text ANYWHERE, even on top of existing text! You can print text sideways, upside down, in mirror image, in 16 colors and a multitude of other ways. But BITMAC text is only a small part of this unique program. Other features of BITMAC will allow you to do things like SIGN your name, make perfect circles ANYWHERE, draw lines from any point of the screen to any other point, make perfect rectangles in EXACTLY the position you want them and much more!

BITMAC has provisions for trackballs, joysticks and even a second computer input! If you have a second computer such as an IBM PC, an Apple Macintosh even an IBM 370 main frame there are provisions for your second computer to create graphics with BITMAC!

BITMAC can make "slide presentations" for group meetings (and print the graphics!), give hours of "just doodling" pleasure, create charts for a stock holder report, print camera ready art for business ads, make still cartoon sequences (and print them in one of two sizes), create mechanical drawings, draft floorplans and many other uses!

BITMAC, with a second computer, can plot satellite data, statistical data, computer generated art plots, analog sampled data and just about anything your second computer can throw at BITMAC.

BITMAC offers BOOLEAN disk input (just like NASA enhances photos!) and a wealth of computer enhancement techniques that lend raw power to your ability to manipulate bitmapped graphics.

BITMAC offers icon input that allows you to point at the functions you want. Nothing was spared in making BITMAC easy and simple to use. Even a child can use it!

BITMAC requires either the Extended Basic, Mini Memory or Editor/Assembler Module, as well as a disk drive system, memory expansion and joysticks or trackball (for precision work).

NOTE: Compatible only with Epson, Star 10X or SG10, or other fully Epson compatible dot matrix printers (the TI-99/4A Impact Printer made by Epson [MX80] requires the upgrade of a GraphTrax or GraphTrax Plus chip set, available from Epson).

Fully compatible with both TI and CorComp Disk Controller Cards.

# ONLY \$19.95 + S&H

BONUS: Comes with Free Print Pack & Disk Examples + Sign Maker

## Now get more out of your TI Home Computer — for less.

ADD A 2ND DISK DRIVE TO YOUR  
TI/99/4A SYSTEM

# Stand Alone Disk Memory Drive System

Comes complete with drive, case, power supply & cable. Ready to connect.

By adding a second drive to your system you can free yourself from swapping program and data disks on many programs. You can also make backups without any disk swapping.



These units are sold with a 90-day warranty.

### EXTRA VALUE BONUS

With each disk drive ordered we are including a HEAD brand disk drive head cleaning kit which regularly sells for \$15.95.



# \$129.95 Plus S&H

## NEW SPECIAL OFFER

### ADD \$20.00 for DS/DD Drive.

## FREE BONUS

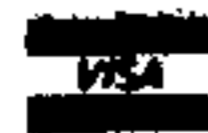

VISA and MASTERCARD  
HOLDERS CALL DIRECT  
(818) 384-8831

24 Hour Order Line

SEND CHECKS AND MONEY ORDERS PAYABLE TO

# TEX-COMP™

P.O. BOX 22004 - ORANGE HILLS, CA 91324

TEXAS INDEPENDENT



AUTHORIZED DEALER

TERMS: All prices F.O.B. Los Angeles. For fastest service use customer check or money order. Add 3% shipping and handling (\$3.00 minimum). East of Mississippi 4%. (Free shipping on all software orders over \$100.00). Prices and availability subject to change without notice. We reserve the right to limit quantities.

NOTE: Payment in full must accompany all orders. Credit Card, Company Check or Money Order for immediate shipment. Personal checks require up to 4 weeks to clear. California orders add 5 1/2% sales tax.

SEND \$2.00 FOR NEW 1986 CATALOG WHICH INCLUDES A \$5.00 SAVINGS CERTIFICATE.

A spelling checker for programmers

# Proofreader detects errors while writing BASIC programs

Proofreader was originally distributed as a Freeware item by Dan Norling. Tragically, Mr. Norling died in December. However, he had provided MICROpendium with a copy of his program for publication.

Following are the requirements under which Mr. Norling distributed his program, and we hope you will agree to honor them. The remainder of the text was written by Mr. Norling.

1. This software is not to be sold for profit or financial gain by any person, users group, or organization.

2. User groups must make it available to members at no charge, except for the usual handling fee for duplication.

3. Freeware concept, program documentation, and author credits must not be removed, modified, or altered in any way.

Proofreader is an Extended BASIC program for the TI 99/4A Home Computer to check the entry of BASIC program statements for correctness. It is similar to programs listed in *Compute!* magazine for the Atari, Commodore, and IBM machines.

---

FAN—

---

(Continued from Page 26)

loosen the screws holding the circuit board on the left side of the PEB and pull it out of the way to reach the lower left-hand nut. Putting the nuts on is easier because the new fan is not as bulky as the original. (The nuts securing the fan are very small, less than 6 millimeters, which is the smallest wrench I had available.)

Putting it all back together is a snap.

My experience with the new fan has been positive. The only problem I've encountered is leaving the PEB on when I've finished with the computer. It's so quiet, I just forget it's on.

The idea behind this program is for the user who types in a program listing to have a check on that work line by line. Then, if any mistake is made, the programmer will know right away something is in error, and not have to hunt down the "bug" later when the full program does not work properly. *Compute!* has been publishing its non-TI program listings with this check feature. Now with Proofreader this can also be done for the TI.

What the program does is take each character entered into the statement and manipulate its ASCII value to produce a unique sum for that statement. This "checksum" is then compared to a known value for the correct statement. If a match occurs, the typed entry is considered correct. Proofreader does not check for syntax or logic errors. The checksum produced by Proofreader is a two-digit alphabetic code.

Proofreader works in the same way as the *Compute!* programs, but with a few changes mainly because of the differences in BASIC between Atari, IBM and Texas Instruments. The Commodore (VIC/64) programs are in machine language, while the TI program is written in Extended BASIC. The IBM program is written in MS-BASIC. TI does not have full screen editing capabilities as does IBM-BASIC. This means that when an error in a program statement entry is discovered, the entire statement must be typed in again. In IBM-BASIC, you can move the cursor around on the screen to any program statement listed, edit that listing, and when enter is pressed, the correction is made for that statement. Unfortunately, TI-BASIC is a line editor and has only single line cursor movement. Proofreader can list to the screen the statements that have been entered, but correction must be made by retyping. That limitation is

not much to sacrifice as Proofreader saves entering unnoticed errors that often consume many hours later when the programmer tries to track down the problem.

Like the IBM proofreader, the saved file is in ASCII format (DIS/VAR 80). It can be edited by TI-Writer, for example. In fact, there is a translator program (XLATE, published in last month's MICROpendium) to make the transformation to XBASIC merge code easy. Extended BASIC loaders for TI-Writer may also be used. Proofreader includes a command to load Tom Knight's TI-Writer loader.

A program can be changed into a form that can be loaded by Proofreader. Just "list" the program from memory to disk with the command LIST "DSKn.FILENAME". Then with TI-Writer, add the FCTN A character to the end of each line that has 80 characters (bumping the 80th character to the next line, etc.). The FCTN A character in the 80th position is Proofreader's method of determining that the statement continues on the next line.

There is a memory limitation to Proofreader due to the capacity of the TI 99/4A to store string data in memory simultaneously. Proofreader can hold about 160-180 multiple statement Extended BASIC program lines before filling up the memory. For programs that go beyond this point, the program can be broken conveniently into two or more parts

## Summary of Proofreader commands

LIST—Lists all program lines to the screen.

CHECK—Lists all program lines to the screen with checksum.

LLIST—Lists all program lines to the screen and a printer.

(Please turn to Page 30)



**TEX+COMP™**

America's Number One TI computer retailer

**SPECIAL**

**OUTSTANDING ARCADE QUALITY GAMES  
for the TI-99/4A**

**MIDNIGHT MASON**

**MICRO PINBALL II**



**DISK ONLY**

**MIDNIGHT MASON**

**THE TI-99/4A ANSWER TO GHOST CHASERS**

A delightful chase through a maze of ladders and brick walls as you direct your mason in collecting his tools. Entertaining animation as the mason climbs, runs, builds, and breaks through brick walls in his attempt to avoid being devoured by not so friendly ghosts. Great arm flexing, leg pumping, pick swinging action. You will play for hours. Requires Extended Basic, 32K and disk drive. \$14.95 + S&H

**MICRO PINBALL II**

Turn your 99/4A into a fast action pinball machine, complete with keyboard operated "flippers" and ball control, absolutely incredible color graphics and performance. \$14.95 + S&H

**SPECIAL BONUS:** MIDNIGHT MASON and MICRO PINBALL II plus 2 additional high-speed arcade games: TI TOAD and BURGER BUILDER. Requires Extended Basic and 32K.

**ALL 4 ONLY \$19.95** Plus S&H

all programs load automatically with Extended Basic

**TEX+COMP proudly presents  
the most outstanding arcade game ever written  
for the TI-99/4A.**

Championship Tennis lets you enjoy the excitement, action and thrills of a professional tennis match with complete control.

The graphic displays are all in dimensional perspective, which adds increased realism.

Thousands of this program have been sold throughout the world for other computers. Now, you can enjoy the ultimate action arcade game on your TI-99/4A. Requires Extended Basic and 32K.

**ONLY \$9.95** Plus S&H

**COMPLETE WITH DOCUMENTATION**

*Now with XBasic  
Auto-Load*

**TENNIS**

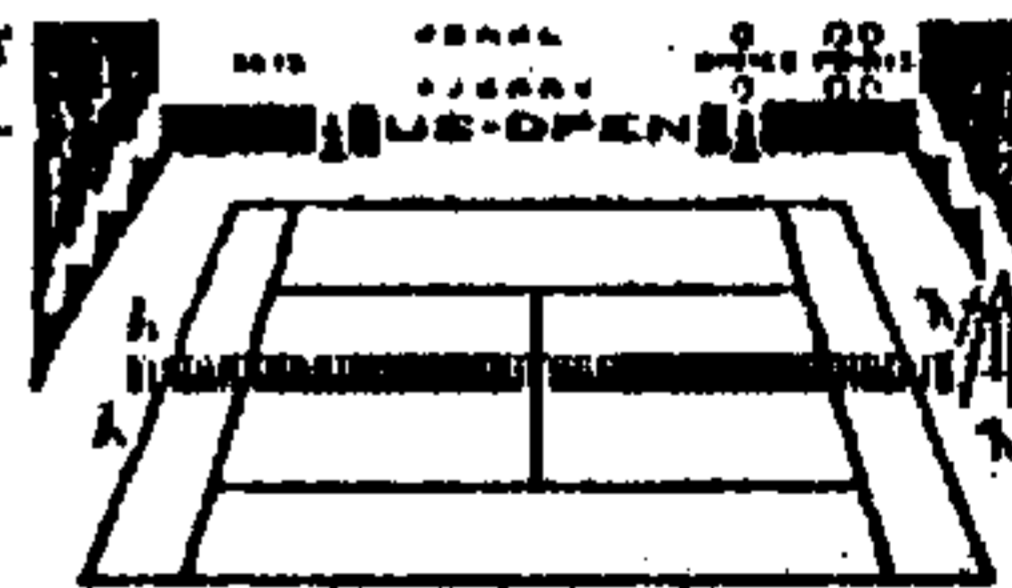

© 1983 NICEWARE

**ALSO INCLUDED:**

A collection of bonus, unreleased TI arcade games are included. They may not be complete or documented, but you'll certainly have a ball with them!

		VISA and MASTERCARD HOLDERS CALL DIRECT (818) 388-6631	SEND ORDER AND MAKE CHECKS PAYABLE TO	
add 3% for credit card orders		<b>24 Hour Order Line</b>	<b>TEX+COMP™</b> P.O. BOX 13004 - GRANADA HILLS, CA 91344	<b>AUTHORIZED DEALER</b>
<p><small>TERMS: All prices FOB Los Angeles. For fastest service use cashiers check or money order. Add 3% shipping and handling (\$3.00 minimum). East of Mississippi 4 1/2%. (Free shipping on all software orders over \$100.00). Prices and availability subject to change without notice. We reserve the right to limit quantities.</small></p>			<p><small>NOTE: Payment in full must accompany all orders. Credit Card, Company Check or Money Order for immediate shipment. Personal checks require up to 4 weeks to clear. California orders add 2 1/2% sales tax.</small></p>	
<b>"The Leader of the Pack!"</b>				

**SEND \$2.00 FOR NEW 1986 CATALOG WHICH INCLUDES A \$5.00 SAVINGS CERTIFICATE.**

# PROOFREADER—

(Continued from Page 28)

**LCHECK**—Lists all program lines to the screen and a printer with checksum.  
**SAVE**—Saves the program lines in memory to a disk file. This “saves” the file in the special format (FCTN A character in 80th position, if necessary) Proofreader uses to “load” a file. Opposite of **LOAD**.  
**CSAVE**—Saves the program lines in memory to a disk file with checksum (no special 80th character).  
**SAVET**—Saves the program lines in memory to a disk file (no special 80th character).  
**DELETE**—Deletes a program from the disk.  
**LOAD**—Loads a program from disk into memory (requires special 80th character in file). Opposite of **SAVE**.  
**NEW**—Erases program lines from memory.  
**CATALOG**—Catalogs a disk to screen and/or printer.

**XLATE**—Run translator program.  
**TIWR**—Run TI-Writer Extended BASIC program loader for those who have it.  
**BASIC**—Return to BASIC.  
 The commands **LIST**, **LLIST**, **CHECK** and **LCHECK** can use a line range argument. The argument starts with an asterisk and ends with a range, e.g. **LIST\*100-200** will list all the lines between 100 and 200.  
 The commands **SAVE** and **LOAD** also use an argument, e.g. **LOAD\*DSKn.FILENAME** or **SAVE\*DSKn.FILENAME**.  
 The **DELETE** command needs an argument, e.g. **DELETE\*DSKn.FILENAME**. To verify the deletion, use the **CATALOG** command.  
**NOTE:** When the TI-Writer program is exited, it returns to the TI title screen instead of Proofreader. This was originally programmed in this manner because the TI-Writer Module

held the cataloging routine. Perhaps someone could modify this to exit to a program of the user's choice and then re-enter TI-Writer. There are several good cataloging programs available.  
 The load of TI-Writer in Extended BASIC was written by Tom Knight.  
 The XLATE program was written by John Ford.

I have used my default printer name in the Proofreader program. To change to your setup, edit lines 620 and 630. The catalog routine will ask for a device name if the screen is not chosen (enter TP for Thermal Printer for example). My default name is: RS232/1.BA=9600.  
 I have also used this same default name in the FORM1 file of the updated TI-Writer. To change this default you will need a sector access program such as DISKFIXER. Here is the procedure:

(Please turn to Page 31)

**TIRED  
 OF TYPING  
 THE SAME  
 COMMAND  
 OVER AND  
 OVER?**

## PROGRAMMABLE CONTROL KEYS

**CNTL 1-9**  
 User redefinable—For commands such as Run, List etc. Up to 140 characters long per key command. Available in command mode.

**CNTL 0**  
 A graphics screen dump any time you want it, whether a program is running or not!

**CNTL =**  
 Catalog disk—Available Anytime—Prints to screen and to printer if specified.

**PCKEYS** also allows you to change the screen and text colors with one command—In immediate or run modes—great for use with monochrome monitors!

**\$22.50**  
 Illinois residents add 7% sales tax

For TI 99/4A only, req. Extended Basic, 32K disk drive and 8 dot addressable, 8 bit printer for screen dump. 100% machine language—Uses no Extended Basic program space.

**PCKEYS Gives You 12 Commands, Each Available With 1 Key Press... In Extended Basic Run or Immediate Mode**

**Techni-Graphics**  
 443 Perrie Dr. #302  
 Elk Grove Vil., IL 60007

## SOUTH JERSEY COMPUTERS

P.O. Box 5, National Park, N.J. 08063  
 (609) 848-5963

- 1200 BAUD VOLKSMODEM WITH CABLE.....\$199.00
- MBX EXPANSION SYSTEM AND BASEBALL.....\$30.95
- DRAGONSLAYER AUTO SPELL-CHECK.....\$31.50
- MILLERS GRAPHICS-ADVANCED DIAGNOSTICS.....\$15.00
- MILLERS GRAPHICS-EXPLORER.....\$18.25
- TI-MULTIPLAN, MINI-MEM, LOGO II or TI-WRITER.....(EACH) \$26.50
- STAR MICRONICS SG10 120 cps PRINTER.....\$239.00
- 6' CABLE (ADD 50 CENTS FOR EACH ADDITIONAL FT) \$22.50
- CORCOMP MICRO-EXPANSION SYSTEM—COMPLETE.....\$329.95
- CORCOMP RS232 CARD.....\$92.50

6% SALES TAX FOR N. J. RESIDENTS  
 ADD \$3.00 POSTAGE AND HANDLING TO TOTAL ORDER  
 (ORDERS OVER \$100.00 ADD \$5.00)  
 MASTERCARD, VISA AND AMERICAN EXPRESS ACCEPTED  
 CREDIT CARD PURCHASE, PLEASE USE THE FORM BELOW OR FACSIMILE

NAME \_\_\_\_\_  
 ADDRESS \_\_\_\_\_  
 CITY \_\_\_\_\_  
 STATE \_\_\_\_\_ ZIP \_\_\_\_\_  
 CARD # \_\_\_\_\_  
 EXP. DATE \_\_\_\_\_  
 SIGNATURE \_\_\_\_\_

-----ALLOW 6 TO 8 WEEKS DELIVERY-----  
 ALL ITEMS SUBJECT TO AVAILABILITY  
 ALL TEXAS INSTRUMENT SOFTWARE SALES ARE FINAL



## PROOFREADER—

(Continued from Page 30)

First, initialize a disk and then copy the FORM1 file to it. This way you will know exactly which sector it starts at (Hex 22). There is an RS232 string in sector 22 but it is NOT the one you

want to change. You will find the string "RS232/1.BA=9600.LF" in sector 2B, beginning at address 1C, and this is the one you want to change to your printer name. Don't forget the .LF or you will get double spacing!

### Proofreader

```

100 !Automatic Proofreader V
ersion 1.0 (TI 99/4A XBasic)
110 !Daniel F. Norling
120 !May 1985
130 DIM A$(500),A(500),B$(5)
:: GOTO 161
140 CALL INIT :: CALL CHAR :
: CALL CLEAR :: CALL SCREEN
:: CALL COLOR :: CALL ERR ::
CALL LOAD :: CALL KEY :: B,
C,D,E,F,G,H,I,J,K,L,M,N,O,P,
Q,R,S,T,U,V
150 C$,D$,E$,F$,G$,H$,I$,J$,
K$,L$,M$,N$,O$,P$,Q$,R$,S$,T
$,U$
160 !2P-
161 CALL INIT :: CALL LOAD(-
31806,80)!Disable Sprite Mot
ion and Quit Key
170 CALL CHAR(48,"003A444C54
6444B8")!Slash The Zero
180 CALL CLEAR :: CALL SCREE
N(16):: FOR H=1 TO 14 :: CAL
L COLOR(H,2,16):: NEXT H ::
P,Q=0 :: A(0)=32767
190 ON BREAK NEXT :: ON WARN
ING NEXT
200 PRINT :: PRINT "Proofrea
der Ready."
210 LINPUT "":N$ :: ON ERROR
980 !Input Here
220 IF N$="" THEN 210 !No Nu
ll Lines
230 IF ASC(SEG$(N$,1,1))>57
THEN 340 !Line Number/Comman
d
240 IF ASC(SEG$(N$,1,1))<48
THEN PRINT "Basic Statement
Must Begin": "With a Line Num
ber!" :: GOTO 210
250 H=POS(N$," ",1):: H=H-1
!Search For First Blank in L
ine
260 O=VAL(SEG$(N$,1,H))!LNUM
=Line Number
270 IF O<1 OR O>32767 THEN E

```

```

=61 :: U=-1 :: N=194 :: GOTO
990 !Invalid Line Number --
> Syntax Error
280 T$=SEG$(N$,H+1,255)!Text
of Statement
290 IF LEN(T$)=1 THEN E=14 :
: U=-1 :: N=196 :: GOTO 990
!No Text --> Syntax Error
300 D=0 :: FOR H=1 TO LEN(N$
):: D=(D+ASC(SEG$(N$,H,255)
)*H)AND 255 :: NEXT H !Check
Sum
310 PRINT :: PRINT CHR$(65+D
/16)&CHR$(65+(D AND 15))&" "
&N$ :: PRINT !Print Check Su
m Line
320 GOSUB 930 :: IF A(Q)=0 T
HEN A$(Q)=T$ :: GOTO 210 !Re
place Line
330 GOSUB 960 :: GOTO 210 !I
nsert Line
340 T$="" :: FOR H=1 TO LEN(
N$):: B=ASC(SEG$(N$,H,255)):
: T$=T$&CHR$(B+32*(B>96 AND
B<123)):: NEXT H !Make Lower
--> Upper Case
350 F=POS(T$,CHR$(42),1):: H
$=T$ :: E$="" !Search for De
limiter
360 IF F THEN H$=SEG$(T$,1,F
-1):: E$=SEG$(T$,F+1,255)!Es
tablish Command and Argument
370 IF H$<>"LIST" THEN 620 !
List to Screen
380 PRINT :: IF E$="" THEN G
=0 :: Q=P-1 :: GOTO 430 !No
Argument
390 F=POS(E$,"-",1)!Range In
dicator for Argument
400 IF F=0 THEN G=VAL(SEG$(E
$,1,LEN(E$))): O=G :: GOSUB
930 :: G=Q :: GOTO 430 !Fir
st Line
410 G=VAL(SEG$(E$,1,F-1)):
M=VAL(SEG$(E$,F+1,255))!Last
(Please turn to Page 32)

```

## AAAA<sup>(AA)</sup> LASER SERVICES

*Produce Professional Quality Typesetting at Low Cost with your TI-99/4A Home Computer and our LaserWriter Printer*

AAAA<sup>(AA)</sup> LASER SERVICES was designed for you, the TI-99/4A Home Computer user. Now you have an easy-to-use system for all your typesetting needs. The high-quality LaserWriter output (90,000 dots per square inch) is excellent for personal publishing. Its flexibility allows you to do simple or complicated work. The low cost will enable you to save 50-85% of normal typesetting costs. You don't need to be a high-volume user.

If you haven't used typesetting before, you will find that your publications will be more readable and look more professional. Since a typeset page has more characters than a typewritten page, it will take up less paper, thereby reducing your printing, binding and mailing costs.

To use this service you will need your TI-99/4A Home Computer. You can use TI-WRITER or any program which produces TI-WRITER readable files (i.e., VARIABLE 80 format). However, you will not use the commands (such as centering, indents, etc.) that are specific to word-processors. Instead, you will use the special typesetting commands (what typeface to use, what size to use, how long to make the lines, etc.) included in our instruction book. When you are through typing your text, you edit and proofread it, and make any corrections necessary. Then you send us your data on disk (Single or Double Sided/Single Density) via U.S. Mail. We process your data through our typesetting software to produce the LaserWriter output which is returned with your disk via U.S. Mail, UPS 2nd Day Air or UPS Next Day Air.

If you're interested in beginning this new and exciting adventure with your TI-99/4A Home Computer... Don't wait—order your AAAA<sup>(AA)</sup> LASER SERVICES Startup Kit now by sending \$5.00 (in U.S. funds) to:

**J & K H SOFTWARE**  
**4911 South 31st Street**  
**Arlington, VA 22206**

## PROOFREADER PROGRAM—

(Continued from Page 31)

```

Line
420 Q=G :: GOSUB 930 :: G=Q
:: Q=M :: GOSUB 930 :: IF Q=
0 THEN Q=P-1 !Find Array Ind
ex for Loop
430 FOR V=G TO Q :: P$=STR$(
A(V))!Print Loop Starts Here
440 IF C=0 THEN C$="" :: GOT
0 470 !Skip Checksum?
450 D=0 :: C$=P$&A$(V):: FOR
H=1 TO LEN(C$):: D=(D+ASC(S
EG$(C$,H,255))*H)AND 255 ::
NEXT H !Checksum
460 C$=CHR$(65+D/16)&CHR$(65
+(D AND 15))& " "
470 IF H$="LIST" OR H$="CHEC
K" THEN PRINT C$&P$&A$(V)!Li
st/Check
480 IF H$="LLIST" OR H$="LCH
ECK" THEN PRINT C$&P$&A$(V):
: PRINT #1:C$&P$&A$(V)!List/
Check to Printer
490 IF H$="CSAVE" OR H$="SAV
ET" THEN PRINT #1:C$&P$&A$(V
)
500 IF H$="SAVE" THEN 510 EL
SE 570
510 Q$=C$&P$&A$(V):: IF LEN(
Q$)<80 THEN PRINT #1:Q$ :: G
OTO 570
520 T=LEN(Q$)/80 :: T=INT(T)
+1 :: R$=""
530 IF T>1 THEN R$=R$&SEG$(Q
$,1,79)&CHR$(124)ELSE R$=R$&
SEG$(Q$,1,79)!Take First 79
and Add CHR$(124) --> "!" Ex
cept for Last
540 Q$=SEG$(Q$,80,255)!Drop
First 79
550 T=T-1 :: IF T=0 THEN 560
ELSE 530
560 PRINT #1:R$
570 CALL KEY(0,L,S):: IF S<>
0 THEN V=Q !Press Key --> St
op Loop
580 NEXT V !End Loop
590 IF F=0 THEN Q=G :: GOSUB
930 :: IF Q=0 THEN Q=P-1
600 C=0 :: IF H$="LLIST" OR
H$="LCHECK" OR H$="SAVE" OR
H$="CSAVE" OR H$="SAVET" THE
N CLOSE #1 !Close File
610 GOTO 200
620 IF H$="LLIST" THEN OPEN

```

```

#1:"RS232/1.BA=9600",OUTPUT
:: GOTO 380 !Open Printer
630 IF H$="LCHECK" THEN OPEN
#1:"RS232/1.BA=9600",OUTPUT
:: C=1 :: GOTO 380 !Open Pr
inter
640 IF H$<>"SAVET" THEN 670
650 IF E$="" THEN 920
660 GOTO 760
670 IF H$="CHECK" THEN C=1 :
: GOTO 380 !Check Routine
680 IF H$<>"DELETE" THEN 720
!Delete Routine
690 IF E$="" THEN 920
700 PRINT :: PRINT "DELETE P
rogram: ";E$ :: INPUT "Are Y
ou Sure? (Y/N) ":O$ :: IF O$
="Y" OR O$="y" THEN DELETE E
$ :: GOTO 200
710 IF O$="N" OR O$="n" THEN
GOTO 200 ELSE 680
720 IF H$="SAVE" THEN 740 !S
ave to Disk
730 IF H$<>"CSAVE" THEN 770
!Check Save to Disk
740 IF E$="" THEN 920
750 IF H$="CSAVE" THEN C=1
760 OPEN #1:E$,OUTPUT,DISPLA
Y,VARIABLE 80 :: E$="" :: G
OTO 380
770 IF H$<>"LOAD" THEN 850 !
Load From Disk Routine
780 IF E$="" THEN 920
790 OPEN #1:E$,INPUT,DISPLA
Y,VARIABLE 80 :: P=0 :: Q=0
800 C$="" :: IF EOF(1)THEN 8
40
810 LINPUT #1:N$ :: IF N$=""
OR N$=" " THEN 810 !Accomod
ates Blank Line Created When
You "LIST" a Program in Mem
ory to a Disk File.
820 IF LEN(N$)=80 THEN N$=SE
G$(N$,1,79):: C$=C$&N$ :: GO
TO 810 ELSE C$=C$&N$ !Drop 8
0th if 80 Long
830 H=POS(C$," ",1):: H=H-1
:: Q=VAL(SEG$(C$,1,H)):: A(Q
)=0 :: A$(Q)=SEG$(C$,H+1,255
):: Q=Q+1 :: GOTO 800
840 P=Q :: CLOSE #1 :: GOTO
200
850 IF H$<>"NEW" THEN 880 !E
rase Program in Memory
860 PRINT :: PRINT "Erase Pr

```

```

ogram" :: INPUT "Are You Sur
e? (Y/N) ":U$ :: IF U$="Y" O
R U$="y" THEN P=0 :: GOTO 20
0
870 IF U$="N" OR U$="n" THEN
200 ELSE 860
880 IF H$="BASIC" THEN CALL
CLEAR :: CALL INIT :: CALL L
OAD(-31952,255,231,255,231)!
Clear PROOFREADER --> Return
to Basic
890 IF H$="CATALOG" THEN GOS
UB 1020 :: GOTO 200 !Catalog
Disk
900 IF H$="XLATE" THEN RUN "
DSK1.XLATE" !Run Translate P
rogram
910 IF H$="TIWR" THEN RUN "D
SK1.TIWR" !Run TI-WRITER
920 PRINT :: PRINT "Syntax E
rror" :: GOTO 200
930 Q=0
940 IF Q)A(Q)AND Q<P THEN Q=
Q+1 :: GOTO 940 ELSE RETURN
950 P=P-1 :: FOR V=Q TO P ::
A(V)=A(V+1):: A$(V)=A$(V+1)
:: NEXT V :: RETURN
960 P=P+1 :: FOR V=P TO Q+1
STEP -1 :: A(V)=A(V-1):: A$(
V)=A$(V-1):: NEXT V !Make Ro
om For New Line
970 A$(Q)=T$ :: A(Q)=0 :: RE
TURN
980 CALL ERR(E,U,R,N)!Error
Routine
990 PRINT "Error #";E;" Type
";U;"In Line #";N :: IF Q<1
OR Q>32767 THEN 210
1000 IF LEN(T$)=1 THEN 210
1010 RETURN 210
1020 CALL CLEAR !Catalog Rou
tine
1030 B$(1)="DIS/FIX" :: B$(2
)="DIS/VAR" :: B$(3)="INT/FI
X" :: B$(4)="INT/VAR" :: B$(
5)="PROGRAM"
1040 DISPLAY AT(12,1):"MASTE
R DISK (1-3) 1" :: ACCEPT AT
(12,19)SIZE(-1)VALIDATE("123
")BEEP:H :: DISPLAY AT(14,1)
:"SELECT SCREEN (0)":"DEVICE
NAME (1) 0" :: ACCEPT AT(
15,19)SIZE(-1)VALIDATE("01")
BEEP:I

```

(Please turn to Page 33)



**PROOFREADER—**

(Continued from Page 32)

```

1050 IF I=0 THEN 1070
1060 DISPLAY AT(19,1):"DEVIC
E NAME:" :: ACCEPT AT(20,1)S
IZE(-40)VALIDATE(UALPHA,DIGI
T,"./="):J$ :: OPEN #I:J$,OU
TPUT.
1070 OPEN #3:"DSK"&STR$(H)&"
.",INPUT ,RELATIVE,INTERNAL
:: INPUT #3:C$,J,J,K :: PRIN
T #I :: IF I=1 THEN PRINT
1080 PRINT #I:TAB(9);"CATALD
G DISK" :: IF I=1 THEN PRINT
TAB(9);"CATALOG DISK"
1090 PRINT #I :: IF I=1 THEN
PRINT
1100 I$=" "&STR$(K):: K$="
"&STR$(J-K):: M$=SEG$(I$,LE
N(I$)-2,3):: S$=SEG$(K$,LEN(
K$)-2,3):: PRINT #I:"DSK";ST
R$(H);" - DISKNAME=";C$:"A
VAILABLE=";M$;" USED=";S$
1110 IF I=1 THEN PRINT "DSK"
;STR$(H);" - DISKNAME=";C$
:"AVAILABLE=";M$;" USED=";
S$
1120 PRINT #I:" FILENAME SI
ZE TYPE P:"-----
-----":: IF I=
1 THEN PRINT " FILENAME SIZ
E TYPE P:"-----
-----"
1130 INPUT #3:C$,H,J,K :: PR
INT #I :: IF I=1 THEN PRINT
1140 IF LEN(C$)=0 THEN 1210
1150 G$=" "&STR$(J):: L$=SE
G$(G$,LEN(G$)-2,3):: PRINT #
I:C$;TAB(13);L$;TAB(17);B$(A
BS(H));:: IF I=1 THEN PRINT
C$;TAB(13);L$;TAB(17);B$(ABS
(H));
1160 IF ABS(H)=5 THEN 1180
1170 F$=" "&STR$(K):: PRINT
#I:SEG$(F$,LEN(F$)-2,3)::
IF I=1 THEN PRINT SEG$(F$,LE
N(F$)-2,3);
1180 IF H>0 THEN 1130
1190 PRINT #I:TAB(28);"Y";::
IF I=1 THEN PRINT TAB(28);"
Y";
1200 GOTO 1130
1210 CLOSE #3 :: PRINT #I ::
IF I=1 THEN PRINT
1220 PRINT #I :: IF I=1 THEN
(Please turn to Page 34)
    
```

Texaments, Insebot, and Dave Ross join forces with...

Version 2.0 **TI Artist** All New!  
**And Companion**

Powerful Slide Features



Multiple Character  
Multiple Font Entry

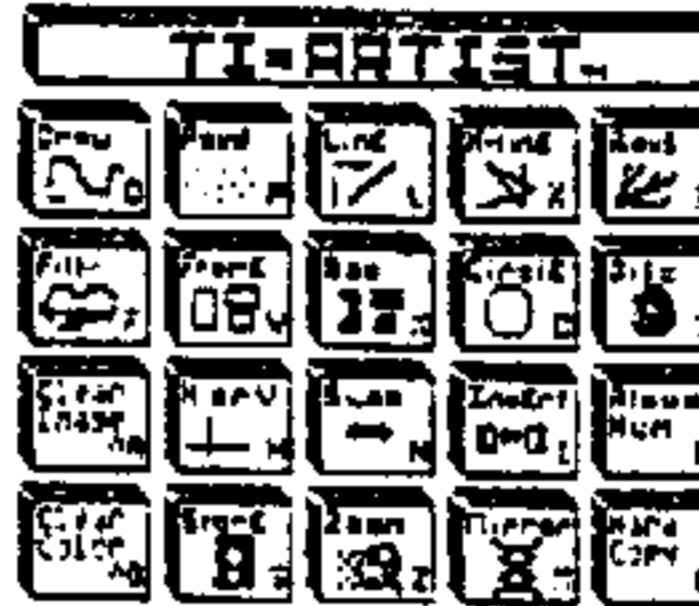

Move, Copy and Flip

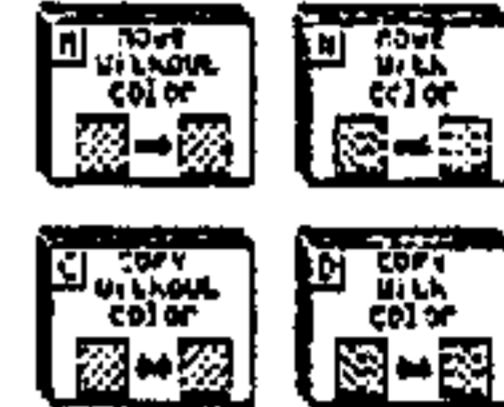

User Defined Picture Areas

TI Artist allows the user endless possibilities/many unique features. The picture oriented menu's (shown above) are easy to use and informative. TI Artist provides excellent user adjusted screen image dumps that work with Okidata 92 or 93, Epson, Axidom GP-100 and Prowriter printers. Minimum system configuration required: Disk system, 32K memory exp, and either E/A, MM, XB, TI Writer, Cor Comp disk manager or Myarc disk controller card.

**Artist's Companion**

Artist's Companion is a complete package that adds a complete set of graphic tools to be used in conjunction with TI Artist (V 2.0) to help aid in graphic picture design. A set of five (5) single sided, single density diskettes include 25 character fonts, 160 5x5 (pixel) original graphic characters and 30 assorted pictures (instances). Artist's Companion is a must for designing almost anything, including ads like this one! A truly great value.

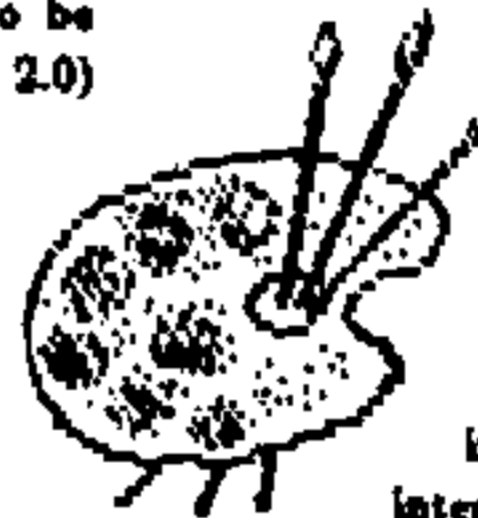

**Artist Extras**

Artist Extras is a small, but complete set of graphic tools to be used with TI Artist (V 2.0) to help aid in graphic picture design. Totally different from Artist's Companion, Artist Extras include 14 character fonts, 5 assorted pictures (instances), 6 full screen pictures and complete input device DSR routines to aid in interfacing a mouse and Super Sketch pad device. All this comes packed on a "flippy" disk and is a must for the TI Artist owner.

Companion \$17.50  
Extras \$6.95

Texaments  
53 Center Street  
Patchogue, NY 11772

TI Artist \$19.95  
All Three \$41.95

All orders shipped in 48 hours upon receipt. Add \$1.50 postage and handling for each item ordered. Sorry, no C.O.D. or credit card orders accepted. Prices and availability subject to change without notice. Call our office (516-475-3480) or bulletin board service (516-475-6463) for additional information. We support a full line of TI-99/ta and IBM PC products. Quantity discounts available.

**MYARC 300/1200 Baud Smartmodem**

Only \$259.95

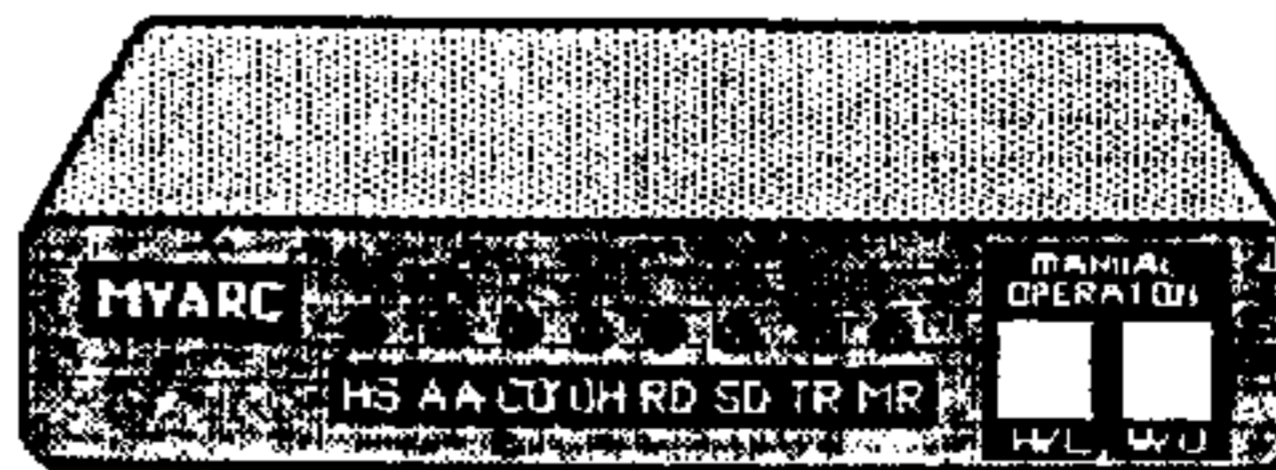

Only \$259.95

Fully Hayes Compatible, Fully TI Compatible

**100% TI COMPATIBLE CANON DISK DRIVES**

Canon MDD210 Full Height DS/DD 6ms Drives

\$79.95  
Bare

Order bare and install yourself, or order it complete with power supply, case and cable!

\$159.95  
Complete

Texaments

53 Center Street, Patchogue, NY 11772

(516)475-3480 Technical Hotline (516)475-6463 Data Hotline

Please add \$3.50 for postage and handling for each item ordered.

# Festivals, festivals!

## Fest-West set in LA

The Los Angeles 99er Computer Group will host the 99 Fest-West '86 March 1-2 at the Shrine Exposition Hall, 700 West 32nd St., Los Angeles, California.

Events include presentations, seminars and mini-workshops, according to Terrie Masters, LA 99ers president.

"Anchor" vendors for the event are Millers Graphics and Myarc, Masters says. She says that "there is a good chance that at least one of the two, if not both, will be unveiling a new product" during the event.

Some vendors not attending in person will be sending videotaped demonstrations of their products, available for viewing to fest-goers, Masters says.

The event is held in conjunction with Computer Sellathon & Expo, she says.

Advance admission is \$4 for both days, \$5 at the door with a coupon available from the LA 99ers. Discounted air, hotel and tour rates are available to persons attending. For early arrivals tours of Disneyland, Universal Studio and whale watching have been arranged, Masters says.

For coupons and information regarding the Fest-West or for information regarding hotel location, rates and tours contact T.A. Masters, 148 S. Maple Drive, Beverly Hills, CA 90212. Masters asks that persons writing in-

clude a stamped, self-addressed envelope.

## Wisconsin TI Show

The Wisconsin 99er Computer Council is planning to host a TI Dealer Show And Sale from 9:30 a.m. to 4 p.m. March 1 at the VFW Hall in Green Bay.

Bruce Murray of the Wisconsin 99er Computer Council says vendors will be charged \$20, \$10 of which will be refunded if vendors are able to vacate the hall by 5 p.m.

For further information, contact W99CC, c/o Bruce Murray, P.O. Box 1031, Fond du Lac, WI 54935.

## TICOFF slated in NJ

Educational programs, hardware and software demonstrations and a flea market are scheduled for the TICOFF (Texas Instruments Computer Owners Fun Festival) March 15 at Roselle Park High School in Roselle Park, New Jersey.

Speakers scheduled include Lou Phillips of Myarc, John Brown, Paul Charlton, Dr. David Jagerman of Bell Labs, Jay Halovacs, Greg Kean of Kean Computing and Chris Faherty, author of TI-Artist, according to Steve Citron, coordinator of the conference.

Citron says users groups in New Jersey, New York, Massachusetts, Delaware, Pennsylvania and Maine are participating in sponsoring the conference.

Citron says Roselle Park High School is close to mass transportation and major auto routes and has ample parking. He says the school has made the auditorium, cafeteria and 10 classrooms available for the conference. He notes that persons wishing to travel to the conference may contact the travel coordinator: Monarc Travel, Attn. Mrs. Tillie Blahsky, 1429 US Route 22,

Mountainside, NJ 07092 or (201) 654-6211.

For further information contact Citron at 981 Townley Ave., Union, NJ 07083 or (201) 686-0626 or Jeanette Shader, (201) 929-0532 or BBS (201) 929-8161.

## TIMARC set for April

The TI Metropolitan Area Regional Conference of User Groups will be held 1-6 p.m. April 12 at Queensborough Community College in Bayside, New York.

The conference for TI99/4A user groups from New York and New Jersey will be hosted by the QB-99'ers.

According to the organizers, tutorials on hardware and software development and maintenance will take place from 2 to 5 p.m. Exhibits by distributors, publishers and manufacturers may be viewed before and after the lecture program.

Admission is free upon presentation of a recognized TI users group ID, \$1 for nonmembers of users groups. Parking at the college is free.

Further information may be obtained by sending a self-addressed stamped envelope to Frank Cotty, Queensborough Community College, 56th Ave. and Springfield Blvd., Bayside NY 11364.

## Australian TI Fair

The first Australian TI99/4A Users Fair, sponsored by the Melbourne TI User Group, is scheduled June 14 at the Malvern Town Hall.

For further information, write TI-FAIR, P.O. Box 595, Marrickville, NSW 2204, Australia. Enclose a self-addressed envelope and International Reply Coupons (available from the Post Office).

## PROOFREADER—

(Continued from Page 33)

```

PRINT
1230 IF I=0 THEN 1250
1240 CLOSE #1
1250 DISPLAY AT(23,1):"CATAL
OG AGAIN? (Y/N) N" :: ACCEPT
AT(23,22)SIZE(-1)VALIDATE("
YNyn")BEEP:D$ :: IF D$="Y" T
HEN 1020
1260 RETURN
    
```



## Assembler tutorial

# Let there be sound

By MACK McCORMICK  
Technical Editor

As you know from your BASIC programming, sounds can be from 110 Hertz to 44,733 Hertz, plus eight noises can be generated. Durations may be from 1 to 4,250 milliseconds. (.001 to 4.25 seconds).

The volume can be from 0 (loudest) to 30 (quietest). Up to three tones and one noise may be generated simultaneously by the TMS9919 sound generator controller chip.

Three steps must occur to produce a sound using assembly language:

1. Load the Sound Table which begins at VDP address >83CC with the sound data.

2. Set the least significant bit of the byte at CPU address >83FD to indicate to the computer that the sound table is in VDP RAM.

3. Enable interrupts by using the LIM1 2 instruction.

Once each of these conditions are met you can start the sound generator by placing a value of >01 at CPU address >83CE. This address is used by the interrupt routine as a count-down timer during sound generation.

## The Sound Table

You must produce a sound table which describes the characteristics of the sound you wish to produce. The sound generators are numbered 1, 2 and 3. To produce a sound, you must enter the following information:

1. Specify the tone generator
2. Frequency
3. Volume
4. Duration

Noises:

1. White or Periodic
2. Shift Rate
3. Volume
4. Duration

All bytes are specification bytes except duration. It takes three specification bytes to hold the generator, volume and frequency. The frequency must be entered as a code. (See Fig. 1.)

(Please turn to Page 44)

FIGURE 1: SPECIFICATION BYTES FOR TONES

Byte	Bit#	Contains
ONE	0	Always set to 1
	1-2	Specifies the sound generator
	3	Always 0
	4-7	Contains the 4 least significant frequency code bits
TWO	0 - 1	Always 00
	2 - 7	Contains the 6 most significant frequency code bits
THREE	0	Always 1
	1-2	Indicates sound indicator used
	3	Always 1
	4-7	Volume level

```

*****
* ACCOMPANIES THE SOUND TUTORIAL *
* PLAYS "HOME ON THE RANGE" *
* *
*****
DEF START
REF VMBW
* SET UP VARIABLES FOR PROGRAM
MYREG BSS >20
SOUNDT EQU >1000 SOUND TABLE ADDRESS
ONE BYTE >01
EVEN FORCE LOCATION COUNTER TO WORD BOUNDRY
* FIRST EXECUTABLE INSTRUCTION
START LWPI MYREG
LI R0,SOUNDT
LI R1,SDATA SOUND DATA
LI R2,274
BLWP @VMBW
* GENERATE THE SOUND
LOOP1 LIM1 0 LOAD INTERRUPT MASK IMMEDIATE
LI R10,SOUNDT LOAD R10 WITH SOUND TABLE ADDRESS
MOV R10,@>83CC VDP SOUND TABLE
BDCB @ONE,@>83FD SET ONES CORRESPONDING BYTE (SOUND TABLE IN VDP RAM)
MOVB @ONE,@>83CE START SOUND PROCESSING
LIM1 2
LOOP2 MOVB @>83CE,@>83CE #WHEN CPU ADDRESS >83CE = 0
JED LOOP1 #SOUND PROCESSING IS
JMP LOOP2 #FINISHED & PROGRAM REPEATS
* SOUND DATA
SDATA BYTE >03,>8D,>11,>91,40
BYTE >04,>AD,>11,>9F,>B1,40
BYTE >03,>A6,>0D,>B1,40
BYTE >06,>BE,>0B,>AD,>11,>95,>B5,40
BYTE >09,>BA,>0A,>A6,>0D,>CD,>11,>95,>B5,>D5,60
BYTE >05,>86,>0D,>91,>BF,>DF,20
BYTE >03,>82,>0E,>91,40
BYTE >03,>BE,>0F,>91,40
BYTE >03,>80,>0A,>91,40
BYTE >04,>A0,>0A,>9F,>B1,40
BYTE >09,>80,>0A,>A6,>0D,>CD,>10,>95,>B5,>D5,60
BYTE >05,>80,>0A,>91,>BF,>DF,20
BYTE >03,>80,>0A,>91,20
BYTE >03,>BF,>0B,>91,40
BYTE >09,>8A,>0A,>A6,>0D,>CD,>11,>95,>B5,>D5,40
BYTE >05,>86,>0D,>91,>BF,>DF,20
BYTE >04,>A6,>0D,>9F,>B1,40
BYTE >05,>C6,>0D,>9F,>BF,>D1,40
BYTE >03,>C2,>0E,>D1,40
BYTE >03,>C6,>0D,>D1,40
BYTE >03,>CE,>0B,>D1,80
BYTE >03,>CD,>11,>D1,40
BYTE >04,>BD,>11,>91,>DF,40
BYTE >03,>86,>0D,>91,40
BYTE >06,>BE,>0B,>AD,>11,>93,>B3,40
BYTE >09,>8A,>0A,>A6,>0D,>CD,>11,>95,>B5,>D5,60
BYTE >05,>86,>0D,>91,>BF,>DF,20

```

(Please turn to Page 44)

## Night Mission

## It's a game, it's a tutorial, it's...

By ROBERT CARMANY

When I read the descriptive literature about Night Mission from Millers Graphics ("award winning program...outstanding graphics") my first thought was (yawn!) another shoot 'em up game with probably exaggerated promotional hype. After all, how many software packages live up to the promotional literature? But, it is produced by Millers Graphics so just maybe....

Night Mission poses an immediate problem when it comes time to review it. Do you review that package as an arcade game or as a programming tutorial? It qualifies in both categories.

**Performance:** Night Mission is produced on cassette tape with a total of five programs on both sides of the tape. One side contains the joystick and keyboard versions of the program for cassette-based systems and the other side has the joystick and keyboard programs for disk systems along with a LOADER program. All of the programs loaded flawlessly and the instructions in the manual (more on it later!) were explicit, clear and well-written.

The game itself is simple and easy to understand. You are a helicopter pilot charged with a covert rescue mission. The object of the mission is to rescue and transport as many men as you can, five at a time, to a ship waiting offshore. All the while, you must avoid tanks, planes, missiles and enemy helicopters.

Each of the levels starts with a "Tank screen" and ends with a "Ship screen." A complete description of the game scenario and scoring is also provided.

The graphics are excellent. The characters are sharp and well-defined and the response in both joystick and keyboard versions is very good. Craig Miller and Mike McCue have used three characters to depict your helicopter flying forward, backward or

---

## Review

---

### Report Card

Performance .....	A
Ease of Use.....	A
Documentation .....	A
Value.....	A
Final Grade.....	A

**Cost: \$19.95**

**Manufacturer: Millers Graphics, 1475 W. Cypress Ave., San Dimas, CA 91773**

**Requirements: Console, monitor or TV, Extended BASIC, cassette recorder. Disk system and joysticks are optional.**

---

in level flight. There are also multiple characters for the animated passengers who are the object of your mission.

Everything is so well done that it is difficult to believe the program is written in Extended BASIC rather than assembly language—it is of true arcade quality. The action is fast, furious and

very engrossing. I had trouble getting my kids to quit playing Night Mission—so I could!

**Ease of Use:** The programs load easily from cassette and the disk versions are easily reloaded by following the clear, concise instructions. The basic idea of the game is simple and easy to understand. Even my 10-year-old understood the game the first time he played it without any trouble.

**Documentation:** The package comes with a 90-page booklet. That's right, 90 full pages!

The first two sections deal with loading the game and a description of the game scenario and the scoring. Just what you would expect in a first-class game.

What follows is of special interest to those of us who are interested in the "why's" and "how's" of programming. The next section is a tutorial on Boolean functions, in particular, the function "AND". The uses of "AND" in programming applications are explained far beyond the paltry two-page discussion in your Extended

(Please turn to Page 39)

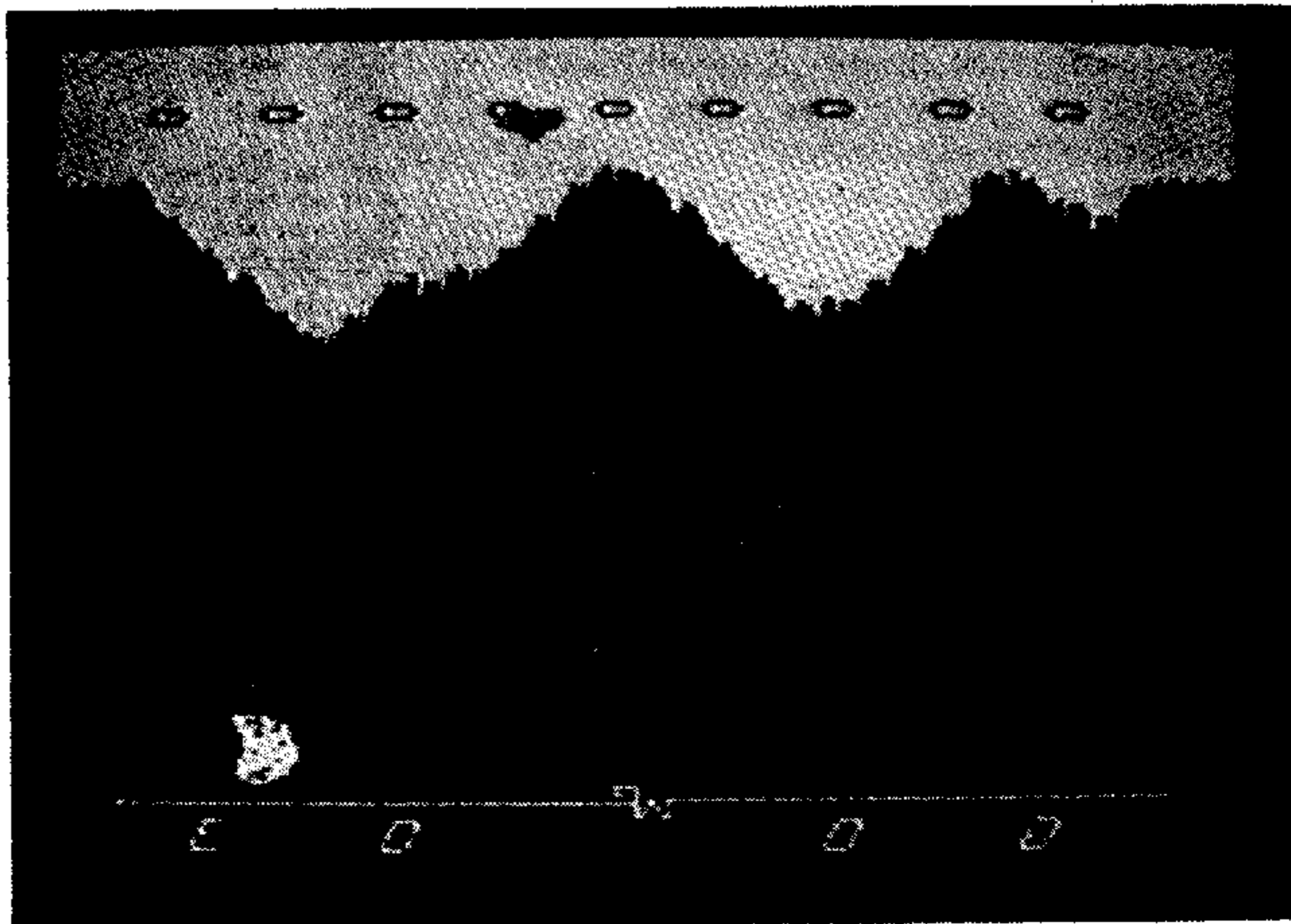



## Peripheral Diagnostic Module

## When all else fails . . .

By JEFF SHAW

The Peripheral Diagnostic Module (PDM) is the first comprehensive system diagnostic tool for the TI99/4A. With this product, one can test the disk controller and drive(s), 32K memory expansion card and the RS232 card.

This package consists of a command module and a loop-back plug which is used in the RS232 test. The module format is useful since, if a problem is found, each component of the system may be removed to help isolate the trouble.

Since the disk tests are first on the main menu, we will discuss these first.

The disk test screen lists seven options. The first four options constitute the disk read/write test. The first option is used to select single-sided, single-density operation. The rest list all other configurations up to double-sided, double-density.

After the appropriate format is chosen, a destructive disk test is performed. The program writes to 32 randomly selected disk sectors. After writing, these same sectors are then read from. The user is informed of the status of the test by a message on the screen, indicating which sector is being operated on. If no problems are found, a message to that effect is displayed and the user may return to the main menu screen. If an error is found, one of seven error messages is displayed. These messages are listed in the documentation along with the possible causes of the problem.

The fifth option on the disk test screen allows one to select the drive to be tested (1-3 for the TI disk controller, 1-4 for the CorComp or Myarc controllers).

The sixth option allows one to display the DIP switch settings on the CorComp disk controller. With the TI controller, all drives will show a value of 20.

The final disk test measures the

---

## Review

---

### Report Card

Performance .....	A
Ease of Use.....	A
Documentation .....	B
Value.....	C
Final Grade.....	B

Cost: \$24.95

Manufacturer: CorComp Inc., 1255 N. Tustin Ave., Anaheim, CA 92807

Requirements: console, monitor or TV, one of the following: disk controller and drive, 32K memory expansion, RS232 card

motor speed of a disk drive (in RPM). The acceptable speed range along with the current drive speed are displayed. Note that a disk must be in the drive for the test to work (not mentioned in the documentation) and that the test may be terminated by pressing the BACK key (FCTN 9). The test continues for some time if not aborted by the user.

The next tests are the 32K memory expansion tests. There are two tests available. The first is a memory bit check, the second, a memory retention test.

The bit check first writes to, then reads from all 32,768 bytes of memory in the expansion card. This test is FAST (on the order of 2 seconds). When the test is completed, a message indicating success, or lack thereof, is displayed.

The second test again writes to all 32K bytes of memory. This time, though, several seconds are allowed to pass before the memory is read from. This tests the memory card's ability to retain data. While the test is in progress, a counter is displayed on the screen to keep the user informed about what is happening. If an error is found,

the user will be advised of the address at which the error was found, the value that was written and the value read.

The next set of tests operates on the RS232 card. There are four tests available.

The first two tests require a printer and are the same except that the first utilizes port 1 of the RS232 interface while the second uses port 2 (Y-cable required). These tests write the complete character set twice. The test is successful if the characters printed by the printer are the same as those given in the documentation. The user is allowed to select the appropriate baud rate for the printer. Unfortunately, the number of data bits and the parity cannot be selected. These are set to the TI default settings of 7 data bits and odd parity.

The third test makes use of the loop-back plug mentioned earlier. This is a 34-pin connector in which some of the pins have been connected. This makes it possible to test the RS232 interface without a printer. The plug is connected to the RS232 port. Data is sent out from one port and received by the other. The characters being sent are displayed on the screen.

The fourth test is the same as the first two except that it makes use of the PIO port. A parallel printer must be connected. Since I do not own a parallel printer, I was not able to evaluate this test.

**Performance:** All the tests performed flawlessly as far as I could tell. The tests were surprisingly fast.

**Ease of use:** The program was very easy to use. It is menu-driven and uses the familiar BACK key (FCTN 9) to move between levels.

**Documentation:** The documentation comes on three 8½ by 11-inch sheets, folded to make a small booklet, which would have been fine if the booklet had been stapled together. Unfortunately, it is not. The documentation is brief,  
(Please turn to Page 39)



BA-Writer

# Word processing made easier

By JOHN KOLOEN

The more you use TI-Writer, the more you will appreciate BA-Writer.

The BA-Writer programs allow users to use TI-Writer with any one of four cartridges—Extended BASIC, Mini-Memory, Editor/Assembler and TI-Writer. It can also be loaded from the CorComp Disk Manager load file option. BA-Writer also provides a Show Directory option that is much faster than the TI-Writer directory option, and it runs out of the Editor as well as the Formatter. Users may also modify default settings for screen and text colors, output device and utility filename.

**Performance:** Like its predecessor TK-Writer by Tom Knight, BA-Writer allows TI-Writer users to do their word processing out of Extended BASIC. The convenience of this is obvious: one less cartridge to replace every time you want to use TI-Writer. This is a particular advantage for the many users whose computing consists largely of word processing and Extended BASIC programming.

The most pronounced difference between TK-Writer and BA-Writer is the latter's support of a disk directory function. Other differences includes user-defined default settings and its ability to keep a text file in memory even after quitting the program. This is of limited benefit, but on those occasions when you've forgotten to save a text file prior to quitting, BA-Writer allows you to reload the editor (instantaneously on reload) and save the text. This is analogous to the TI-Writer "Oops" key and the Recover Edit function of TI-Writer. The Recover Edit function won't work under all circumstances, however, while BA-Writer will keep the text in memory until something other than the editor is loaded or the computer is turned off.

Back to the directory function, the author of this program, Paolo Bagnaresi, did a favor for every TI-Writer user by not trying to emulate

## Review

### Report Card

Performance .....	A
Ease of Use .....	A
Documentation .....	A
Value .....	A
Final Grade .....	A

Cost: \$10

Manufacturer: Paolo Bagnaresi, Via J.F. Kennedy 17, 20097 San Donato Milanese, Italy

Requirements: Console, monitor or TV, memory expansion, Extended BASIC, Mini-Memory, TI-Writer or Editor/Assembler (TI-Writer program files required), disk system

the standard Texas Instruments directory format, which is used in virtually all TI cartridges. The primary problem with the TI directory is that it is painfully slow, particularly with the disks that include dozens of files and pro-

grams. Running a directory on a double-sided, double-density diskette can test even the most patient of hobbyists. Those who are well organized can schedule such household chores as loading and unloading the washing machine around the running of a directory out of TI-Writer. But noooo more. With BA-Writer, the directory listing appears in the same sequential mode as the TI-Writer directory but operates much faster. In fact, the biggest adjustment you'll have to make is to keep your finger ready to pause the directory before it overwrites the directory screen with incoming directory information. This is a problem we could all learn to deal with.

The directory operates out of the editor or formatter, which is a big convenience. Is there a TI-Writer user who, having entered the formatter, couldn't quite remember the name of a text file and had to leave the formatter, reload the editor and running a directory to find it? I've done it at least once. With BA-Writer, you can call up

(Please turn to Page 39)

DISK/TYPE	FREE	USED		
	20	1418		
PR. NAME.	SECT.	TYPE	LENGTH	P
LABELS	22	PROGRAM		N
LETTERHEAD	3	DIS/APP	80	N
LETTERHEAD	3	DIS/APP	80	N
EDIT	17	PROGRAM		N
EDIT-BA	17	PROGRAM		N
EDIT-BA	2	DIS/APP	80	N
EDIT-BA	2	DIS/APP	80	N
EDIT-BA	1	INT/APP	100	N
EDIT-BA	242	DIS/APP	80	N
EDIT-BA	213	DIS/APP	80	N
EDIT-BA	26	PROGRAM		N
EDIT-BA	33	PROGRAM		N
EDIT-BA	33	PROGRAM		N
EDIT-BA	33	PROGRAM		N
EDIT-BA	2	DIS/APP	80	N
EDIT-BA	6	PROGRAM		N

PRESS ANY KEY TO RETURN



## NIGHT MISSION—

(Continued from Page 36)

BASIC manual. What's more, this short course is understandable.

The next section is a complete description of the character sets, characters, colors and variables used in the actual program. All of this is a prelude to the "meat" of the tutorial which follows.

The main thrust of this extensive documentation is a complete dissection of the program and an in-depth tutorial in Extended BASIC programming. The program itself is dissected on a line-by-line basis with each line being thoroughly explained. All of the professional "tricks of the trade" that were used to create Night Mission are explained. This "flow chart" approach is the most comprehensive graphics programming tutorial that I have seen. It touches on all aspects of sprite control and character definition.

[Users can use the "flow chart" to increase or decrease the difficulty of the game—Ed.]

In addition, there is a short section with some documented CALL PEEKs and CALL LOADs, some of which appeared in *The Smart Programmer* and others of which are completely new.

The appendices contain the complete listing of all five programs as well as the character diagrams and hexadecimal codes for each.

The documentation presents a unique and complete approach to a programming tutorial as well as the first-class explanation of a top-flight arcade game.

**Value:** The Night Mission package is one of the best deals around. Either the game itself or the manual, marketed separately, would be well worth the retail price of \$19.95. The game is of true arcade quality and is comparable in value to the very best on the arcade game market today. That, combined with the extensive and thorough documentation, makes Night Mission the latest outstanding contribution from the already impressive list of Millers Graphics introductions.

## BA-WRITER—

(Continued from Page 38)

the directory at any time. A big time-saver.

BA-Writer is not a memory hog, taking up only 64 bytes more than the TI-Writer files. It stores the disk directory and menu screen in VDP RAM. When either is called, the CPU memory that holds text file data will be transferred to VDP RAM while the menu or directory is transferred from VDP RAM into CPU. When the function is terminated, the portion of the text file that was transferred to VDP RAM is written back to CPU RAM. Users don't notice this, because the operation is virtually instantaneous. The BA-Writer program is written in assembly language.

Another improvement over TI-Writer is the convenience it offers in reloading the formatter or editor programs for reuse. In TI-Writer, after a text file has been printed the program returns the user to the main menu. To print another document requires reloading the formatter programs from disk. BA-Writer doesn't automatically leave the formatter at the end of a document but allows you to print other documents. Striking the BACK key will exit the formatter into the main menu. Regarding the editor, the editor and any text left on the screen when you quit the editor remain in CPU memory until you execute another function from the main menu or quit. Selecting the editor function from the main menu will instantly return the user to the editor, text screen intact.

BA-Writer uses an installation program to permanently modify foreground and background color, printer name and utility filename. The documentation more than adequately describes how to use it. While users may modify these parameters using single-sector disk access programs, BA-Writer lets you do it without having to know the correct locations of these parameters in the TI-Writer files. Of course, the user may change these parameters at any time using the installation program.

The BA-Writer program can be

copied to any disk. It does not interfere in any way with the operation of the TI-Writer program. Interestingly, once loaded, the cartridge used to load it—X-BASIC, E/A, MMM, TI-Writer—can be removed from the console without affecting the operation of the program.

The "A" grade for performance is well-earned.

**Ease of Use:** Anyone who can read the documentation should have no trouble in installing or using BA-Writer. TI-Writer will operate exactly as it is supposed to. The only difference is that using it will be more convenient than it was designed to be.

**Documentation:** The seven-page manual is written using TI-Writer. It is outputted on a printer and bound with staples. While it lacks the polish of the TI-Writer manual, it is chock full of information and thoroughly guides the user through the installation and use of BA-Writer files and programs. English syntax is violated only occasionally in this Italian product.

**Value:** There is no question in my mind of the value of this program to TI-Writer users. It gets an "A" not only on the basis of what it does but also on the basis of its price. Now, if someone would develop a way to use macros and perhaps a way of scanning files from the editor.

## PDM—

(Continued from Page 37)

though this program does not require an excess of instructions. The probable causes of errors are listed for most tests, though there are no recommendations on how to solve the problem once found. The instructions note that many disk drive problems are caused by improper motor speed, but do not indicate whether the problem can be fixed by the user or whether the disk drive must be sent out for repairs.

On the plus side, the instructions are clear and grammatical.

**Value:** It is very difficult to assign a  
(Please turn to Page 48)

# Newsbytes

## Vocabulary programs

Gembar Graphics has introduced VOCABULARY SERIES, 12 programs which present 100 words apiece.

The series contains three verbs programs, four adjective programs and five noun programs. The manufacturer says the words were compiled from works whose goal is to prepare the reader for the vocabulary sections of national tests.

The series offers two main modes: the teach mode, in which the words and their meanings are presented to the student for study; and the quiz mode, in which the words are presented in a multiple choice format, with scoring. In both modes, the student can request that the words be presented either alphabetically or in random order. The random ordering features assure that no two learning sessions are the same, according to the manufacturer, who says that the misleads are always different for each vocabulary word each time the program is run.

VOCABULARY SERIES is a three-diskette set written in Extended BASIC and requires expanded memory. It is available for \$26.95 including postage and handling (Florida residents add 6 percent sales tax). It can be ordered by sending a check or money order to Gembar Graphics, 455 Amherst Circle East, Satellite Beach, FL 32937.

## User Group Network

A User Group Network is being formed with a letter of announcement sent to all known users groups, according to Terrie Masters of Beverly Hills, California.

The group was formulated by Masters; Jim Sydlowski of St. Louis, Missouri; Cricket Raybern of Portland, Oregon; Dave Taylor of Daytona Beach, Florida; Bill Whitmore of Washington, D.C.; Howie Rosenberg of Farmingdale, New York; and Ron Albright of San Antonio, Texas.

A project of the group is circulating video or audio demonstration tapes, available to user groups for \$15.

Masters says a portion of this sum will be dedicated to purchase, duplication and shipping the tapes, the balance toward a newsletter issued every other month.

The initial video demonstration is of Los Angeles programmer Kent Thomson's Real Estate Tax Planning and the Miller Graphics Explorer. This video has been sent to groups which have been requested to copy it and send it to one of the next two groups on a master list, and then send the original video to the other group after showing it to their own members.

For further information, contact Masters at 148 S. Maple Drive, Beverly Hills, CA 90212.

## Asgard on the Mall

Asgard Software of Rockdale, Maryland, has opened a store on CompuServe's Electronic Mall.

According to Chris Bobbitt of Asgard, this is the only store selling TI products on the Electronic Mall. He says that at present the store sells only Asgard products, but the firm is negotiating the possibility of selling others.

The Electronic Mall gives CompuServe subscribers the option of 24-hour shopping through telecommunications, seven days a week, using all major credit cards.

## Tennessee TIBBS

Gary Cox, newsletter editor for the Mid-South 99 User Groups says that the TIBBS board the group runs in Memphis, Tennessee is "one of the most advanced...in the country."

He says the board is running with 128K RAM, a CorComp Triple Tech Clock Card with 64K printer buffer, CorComp disk controller, three DS/DD drives providing about one MEG of disk storage space, Ink Jet printer and a new Myarc 300/1200 baud modem.

"We try to maintain about 30 downloads on the system (TE2 protocol)," he says.

Number for the 24-hour board is

(901) 357-5425.

"For best results call using TE2 or FAST-TERM," Cox says.

## New DISK + AID

Don Thomson of Thomson Software announces that the newest version of DISK + AID, version 3.0 is now available.

He says the new version has been speeded up for faster operation and a new very fast speed loader has been installed on the disk. According to Thomson, the new version will load the program in fewer than seven seconds using the Editor/Assembler, Extended BASIC or Mini-Memory modules.

Legally registered owners of the program may obtain the new version by sending the original disk with \$5 to Thomson Software, 1461 Beach St., Muskegon MI 49441-1099.

## Quality 99 Software compatibility

Larry Hughes, president of Quality 99 Software, announces that all Quality 99 programs will work with all disk controller cards.

All Quality 99 programs will work with the Prowriter printer, Hughes said.

Hughes wrote MICROpendium in response to letters to the editor regarding compatibility. For further information, contact Quality 99 Software, 1884 Columbia Rd. #1021, Washington, DC 20009 or (202) 667-3574.

## Artist's Companion

Texaments has signed an agreement with Dave Rose, author of Character Sets and Graphics Design I and II, for exclusive rights to manufacture and market his software package Artist's Companion.

Artist's Companion is a complete set of five disks containing support items

(Please turn to Page 41)



# Newsbytes

(Continued from Page 40)

for Inscebot's TI Artist graphics design package, version 2.0 only. The five disks include 25 individual character sets to be merged with the Alphanumeric Entry feature of TI Artist, 160 small instances to be interfaced with any user picture screen and 30 full-blown pictures to be used and altered as desired.

According to Steve Lamberti of Texaments, the character set styles range from an IBM-like font to three-dimensional fonts. Cost for the five-diskette set is \$17.50 plus \$2 postage and handling.

For further information, or to order, contact Texaments, 53 Center St., Patchogue NY 11772 or (516) 475-3480.

## TOD Editor revised

Asgard Software announces Version 2.0 of TOD Editor by John Behnke.

The new version is available for \$20. According to Chris Bobbitt of Asgard Software, users who have Version 1.0 of the program may receive Version 2.0 by returning the master disks to Asgard with a check for \$2.29.

TOD Editor is a program which allows users to create their own adventure games using the Tunnels of Doom module.

The new version is not copy protected. According to the manufacturer, this was done to allow the user to make a backup and to allow full compatibility with the Myarc disk controller card.

Also, according to the manufacturer, the loader speed has been greatly increased and the main menu screen in Program "A" has been modified.

The user now also has the option to edit the game description before saving it, according to the manufacturer, and the graphics editor in Program "A" is enhanced. It now has the options of clear pattern to "off" blocks, clear pattern to "on" blocks, horizontal flip, vertical flip, inverse pattern and rotate pattern. It now allows the cursor to be moved without leaving a trail

and lets the pattern be "nudged" in any direction.

Also, the program will operate with all printers, according to the manufacturer. Default configuration is for Gemini printers.

For further information, or to replace or order the TOD Editor, write Asgard Software, P.O. Box 10306, Rockville, MD 20850.

## Dealers get XBII+

Myarc's enhanced version of Extended BASIC, Extended BASIC II+, was being sent to distributors in early February, according to Lou Philips, Myarc president.

Myarc said a shipment was made to Triton Products Company Feb. 2.

## Datax considering developing language

Datax is considering starting the developing of a new programming language for the TI99/4A and would like input from users as to their needs in this area, according to Julian Achim of Datax.

Achim said that such a language will be a true compiler and therefore not need the P-code card.

"Such a language has to be high level enough to appeal to inexperienced users, and we would prefer a structured language such as Pascal, PL/1, C, etc." he said.

He said the company will not consider lower high level languages such as Forth, nor will it consider BASIC. He asks that users contact Datax with their suggestions at 1923 Linden St., Ridgewood, NY 11385 or (718) 417-0165.

## MassCopy won't copy 'funny-sector' disks

An error appeared in Jim Lewis' comparison of copying utilities in our January issue. Lewis wrote that MassCopy "will copy proprietary, dead-sectored, weird track-sectored disks."

However, Steven Lawless, the au-

thor, says that MassCopy will not copy disks protected by the "funny-sector" method.

## DataBioTics sells Super Space

DataBioTics Inc., P.O. Box 1194, Palos Verdes Estates, CA 90274, is offering Super Space for the TI. The cartridge allows users to store programs in the cartridge for later use. The company says that users may also copy ROM-only cartridges to disk for subsequent reloading by Super Space.

The cartridge-based program includes 14 kilobytes of memory, consisting of 6K of GROM (Graphics Read Only Memory) and 8K of RAM. The GROM is TI's standard Editor/Assembler. The RAM provides space for data and program storage.

The cartridge also includes a built-in battery to preserve programs and data in RAM. DataBioTics says that users of Super Space can do anything that can be done with the Editor/Assembler cartridge. Included are PEEK and LOAD capabilities as well as utility routines such as DSRLNK, GPLLNK, VSBW and VMBW.

Included with the package is a 21-page manual and a disk containing sample programs and routines that may be used in assembly language programs. According to Edgar Dohmann, author of the program, \$49.95 is the suggested retail value of an assembled and tested unit and \$42.95 is the price for Super Space in kit form. Users may also purchase the disk and manual only for \$14.95.

Newsbytes is a column of general information for TI99/4A users. It includes product announcements and other items of interest. The publisher does not necessarily endorse products listed in this column. Vendors and others are encouraged to submit items for consideration. Items submitted will be verified by the staff before inclusion and edited to fit the Newsbytes format. Mail items to: MICROpendium, P.O. Box 1343, Round Rock, TX 78680.

# User Notes

## Convert BASIC to Extended BASIC

John Behnke, of the Chicago TI Users Group, has a program that is a real time-saver for those who want to convert BASIC programs into Extended BASIC programs. Called VDP Utility II, the program was published in the Chicagoans newsletter, Chicago Times. Since the VDP II must be merged with the BASIC program you want to convert, it is recommended that you not change the line-numbering. Save the program in MERGE format. After loading a BASIC program in Extended BASIC, merge the VDPUTIL2 program into it and save the two programs as one. Then run it.

The program, requires Extended BASIC, a disk system and memory expansion.

```

32700 !"VDP UTILITY II"
32701 !BY JOHN BEHNKE
32702 !
32703 !CHICAGO, ILL.
32704 !WILL CONVER ANY BASIC
32705 !PROGRAM TO X-BASIC
32706 !DIRECTIONS: LOAD BASI
C
32707 !PROGRAM INTO X-BASIC.
32708 !THEN INPUT:
32709 !"MERGE DSK1.VDPUTIL2"
32710 !WHEN FINISHED, RE-SAV
E
32711 !BASIC PROGRAM. THE RE
SULTING
32712 !PROGRAM WILL RUN IN
32713 !X-BASIC
32714 SUB VDPUTIL2
32715 CALL CLEAR :: CALL INI
T :: CALL LOAD(8196,63,232)
32716 CALL LOAD(16360,80,79,
75,69,82,32,38,12,80,79,75,6
9,86,32,37,164,80,69,69,75,8
6,32,37,36)
32717 CALL LOAD(9491,100)
32718 CALL LOAD(9508,2,224,3
7,20,3,0,0,0,2,0,0,100,200,0
,37,18,4,192,2,1,0,1,4,3,2,3
2,12,4,32)
32719 CALL LOAD(9536,32,24,1
8,184,192,32,131,74,2,1,37,0

```

```

,208,160,131,18,9,130,2,34,2
55,255,4,32,32,44)
32720 CALL LOAD(9562,4,197,2
09,34,36,255,9,132,19,21,4,1
95,60,224,37,18,200,5,131,76
,200,5,131,78,200,5)
32721 CALL LOAD(9588,131,80,
2,5,64,0,161,68,2,131,0,1,17
,6,2,5,65,0,161,67,6,196,200
,4,131,76)
32722 CALL LOAD(9614,200,5,1
31,74,4,192,192,66,5,129,4,3
7,254)
32723 CALL LOAD(9636,2,224,3
7,20,3,0,0,0,4,192,2,1,0,1,2
00,1,37,18,4,32,32,12,4,32,3
2,24,18,184)
32724 CALL LOAD(9664,200,32,
131,74,37,0,184,32,131,18,37
,19,2,3,0,2)
32725 CALL LOAD(9680,4,192,1
92,67,4,32,32,12,4,32,32,24,
18,184,216,224,131,75,37,0,5
,131,136,3)
32726 CALL LOAD(9704,37,18,2
2,242,192,32,37,0,2,1,37,2,1
92,131,2,34,255,254,4,32,32,
36)
32727 CALL LOAD(9726,4,192,2
16,0,131,124,2,224,131,224,4
,96,0,112)
32728 CALL LOAD(9740,3,0,0,0
,4,192,2,1,0,1,4,32,32,12,20
0,32,131,74,37,18,2,1,0,2,4,
32,32,12,4,32)
32729 CALL LOAD(9770,32,24,1
8,184,192,32,131,74,208,32,3
7,19,4,32,32,48,4,91)
32730 CALL LOAD(8194,39,04)
32731 SUBEND
32732 SUB CHAR(A,A$):: L=LEN
(A$)
32733 A$=A$&RPT$("0",16-L)
32734 FOR I=1 TO 16 STEP 2
32735 A1$=SEG$(A$,I,1)
32736 A2$=SEG$(A$,I+1,1)
32737 IF A1$<":" THEN A1=VAL
(A1$)*16 ELSE A1=(ASC(A1$)-5
5)*16
32738 IF A2$<":" THEN A1=A1+
VAL(A2$)ELSE A1=A1+ASC(A2$)-
55
32740 CALL LINK("POKEV",767+
8*A+(I+1)/2,A1)
32741 NEXT I

```

```

32742 SUBEND
32743 SUB COLOR(A,B,C)
32744 CALL LINK("POKEV",2063
+A,(B-1)*16+C-1)
32745 SUBEND

```

## Reading D/V80 sans TI-Writer

Not everyone owns a TI-Writer cartridge, and yet a lot of disk-based software includes documentation designed to be read and printed using TI-Writer. The documentation is stored in a Display/Variable 80 format, which is the file type used by TI-Writer.

Although the TI-Writer cartridge makes reading these files easy, users can do without TI-Writer and read their files, too. Below is a program by Art Byers of the Central Westchester 99ers that appeared in the newsletter of the Capitol Area Users Group of Harrisburg, Pennsylvania. It requires Extended BASIC and a disk system. As written, the program dumps the D/V 80 text file to a printer via the parallel port. Users may also display the text file to the screen.

Here's the program:

```

100 REM*DIS/VAR 80 READER BY
ART BYERS
110 CALL CLEAR :: PRINT "DIS
PLAY VARIABLE 80 READER": :
: : "ENTER 0 FOR SCREEN ":"
ENTER 1 FOR PRINTER"
120 CALL KEY(O,K,S):: IF S=0
THEN 120
130 IF CHR$(K)="0" THEN WP=0
:: GOTO 180
140 IF CHR$(K)="1" THEN WP=1
:: GOTO 160
150 GOTO 120
160 OPEN #1:"PI0"
170 PRINT #1:CHR$(27);CHR$(7
8);CHR$(8)! SET SKIP OVER PE
RFORATION
180 CALL CLEAR :: PRINT " EN
TER NAME OF DIS/VAR 80 FILE
TO BE READ" :: INPUT FILE$
190 IF WP=1 THEN 220
200 CALL CLEAR :: PRINT "PRE

```

(Please turn to Page 43)



# User Notes

(Continued from Page 42)

```

SS SPACE BAR TO STOP THE SCR
EEN SCROLLING, RELEASE TO CO
NTINUE": : : :
210 FOR DELAY=1 TO 500 :: NE
XT DELAY
220 OPEN #2:"DSK2."&FILE$, IN
PUT ,DISPLAY ,VARIABLE 80
230 IF EOF(2) THEN 300
240 LINPUT #2:A$
250 PRINT #WF:A$
260 IF WF=1 THEN DISPLAY A$
270 CALL KEY(0,K,S)
280 IF K=32 THEN 270
290 GOTO 230
300 END

```

## Timing test is BASIC

Edgar Dohmann of the Johnson Space Center Users Group offers a simple means of improving the speed of FOR-NEXT statements.

First write a short program that consists of a FOR-NEXT loop of 1,000 iterations. Then RUN the program and time the execution from the time the enter key is pressed until the READY message appears on the screen. Here's an example:

```

100 FOR I=1 TO 1000
110 NEXT I

```

This operation will provide a benchmark figure for future timing tests. The program should take about five seconds to run. Next, insert a statement to be executed within the loop. Dohmann inserted a line he used to compare Boolean evaluation techniques.

```

100 FOR I=1 TO 1000
110 IF A THEN 300
120 NEXT I

```

The loop took seven seconds to run. He then compared a similarly written line to determine which line would run faster in the loop.

```

100 FOR I=1 TO 1000
110 IF A=1 THEN 300
120 NEXT I

```

The second method took nine seconds to run. Since the program included 1,000 iterations, the "IF A

THEN" statement took two milliseconds to execute each iteration while the "IF A=1 THEN" statement took four milliseconds. He concluded that "the difference of only two milliseconds may not seem significant, but if a number of similar statements are used in a program, the total time may become important."

## Tip to set disk drive speed

The Winnipeg 99/4 Users Group offers a tip on checking and setting the speed of a disk drive. (We recommend users apply it with caution and refer to disk drive manuals for specifics.)

To begin, we're assuming that you suspect a problem with your drive. The major symptom would be difficulty in loading a program from disk.

Remove the drive from its enclosure, without disconnecting any wires. Locate the strobe wheel and check to make sure it has a 60 Hz. mark on it. Refer to the drive manual to locate the speed control pot on the circuit board. Illuminate the area with a fluorescent light and attempt to load a program while watching the wheel. (Those involved with auto mechanics will recognize the similarities between this procedure and checking the timing of a motor.) The marks should appear to stand still if the drive speed is correct. If not, adjust the speed control pot until the marks appear to stand still.

## Disk sweeper may save time

Steve Patterson, of the New Horizons TI99/4A Home Computer Users Group (Ohio), provided members of his group with a nifty program that initializes a disk. Unlike most disk manager programs that provide the same function, this disk sweeper operates out of console BASIC!

The program works by initializing the catalog portion of the disk, without

erasing or reformatting all sectors. The program starts by reading the first sectors of the disk, which include the disk and file names. As the file names are read, the program deletes them. The process takes five passes whether the disk is single- or double-sided, single- or double-density. The length of time it takes to sweep a disk depends on the number of programs and files it has. While this program may not be as fast as disk manager programs, it is perhaps the only disk sweeper available that runs out of BASIC.

Here is the listing:

```

100 CALL CLEAR
110 PRINT "          DISK SWEEP
ER          ERASE AN ENTIR
E DISK          IN LESS THAN
A MIN."
120 PRINT
130 PRINT "          STEVE PATTERR
SON"
140 FOR T=1 TO 5
150 PRINT
160 NEXT T
170 PRINT "PLACE DISK IN DIS
K DRIVE #1  PRESS ANY KEY T
O DELETE"
180 CALL KEY(0,K,S)
190 IF S=0 THEN 180
200 CALL CLEAR
210 R=1
220 OPEN #1:"DSK1.", INPUT , I
NTERNAL,RELATIVE
230 INPUT #1:A$
240 B$=A$
250 GOSUB 430
260 R=R+2
270 INPUT #1:B$
280 IF B$="" THEN 320
290 GOSUB 430
300 DELETE "DSK1."&B$
310 GOTO 270
320 CLOSE #1
330 CALL CLEAR
340 PASS=PASS+1
350 IF PASS=5 THEN 390
360 PRINT ">>> PASS #"
370 CALL HCHAR(23,13,PASS+49
)
380 GOTO 210
390 PRINT "          COMMAND COMPL

```

(Please turn to Page 44)

# User Notes

(Continued from Page 43)

```
ETED          PRESS ANY K
EY"
400 CALL KEY(0,K,S)
410 IF S=0 THEN 400
420 END
430 IF R=24 THEN 510
440 FOR U=1 TO LEN(B$)
450 C$=SEG$(B$,U,1)
460 A=ASC(C$)
470 CALL HCHAR(R,U+3,A)
480 NEXT U
490 R=R+1
500 RETURN
510 PRINT
520 R=23
530 GOTO 440
```

## Search program for programmers

Ever want to find every occurrence of a particular variable without leaving Extended BASIC? A program by Jerry Keisler, of Paris, Texas, does just that. The Find-String program will search a program for whatever string the user requests and then display each program line that contains the string. The output may be directed to the screen or to a printer.

Find-String requires that programs to be searched be filed using the LIST command. The search criteria includes any series of consecutive alphanumeric characters, including spaces. Find-String requires that the program to be searched be stored under the name XXX. Programmers should have little trouble in modifying the program to allow the use of any program name, though using XXX does not seem to be burdensome.

The program requires Extended BASIC and a disk system.

```
1 DISPLAY AT(1,1)ERASE ALL:"
FIND A PROGRAM STRING." : "I
S PROGRAM LISTED AS" : "
LIST "DSK1.XXX" Y" : "LOOK
FOR WHAT STRING?" : : "2.
PRINTER OR 0. SCREEN 2"
2 ACCEPT AT(5,21)SIZE(-1)BEE
P VALIDATE("YN"):ZZ$ :: IF 2
```

```
Z$="N" THEN DISPLAY AT(11,1)
:"INTER LIST "DSK1.XXX"" :
: END
3 ACCEPT AT(9,1)BEEP:YY$ ::
ACCEPT AT(11,25)BEEP SIZE(-1
)VALIDATE("02"):ZZ$ :: ZZ=VA
L(ZZ$):: OPEN #1:"DSK1.XXX",
INPUT :: IF ZZ THEN OPEN #2:
"PIO" :: PRINT #2:"":LOOKIN
G FOR ";YY$:""
4 LINPUT #1:QQ$ :: IF POS(QQ
$,YY$,1)THEN PRINT #ZZ:QQ$ :
: IF ZZ THEN 5 ELSE PRINT :
PRESS ENTER" :: INPUT "":ZZ$
5 IF EOF(1)THEN CLOSE #1 ELS
E 4
6 IF ZZ THEN CLOSE #2 :: GOT
O 1 ELSE 1
```

## Weird Sounds and nothing more

Weird Sounds is a program by David Huggett of the 9T9ers Users Group of Toronto. We found it in the newsletter of the Winnipeg 99/4 Users Group. It requires Extended BASIC and a speech synthesizer. Based on the word used in line 160, it generates a series of very unusual sounds. We didn't think the speech synthesizer had it in it, so to

speak.

Here is the program:

```
100 REM *** WEIRD SOUNDS ***
110 REM BY DAVID HUGGETT
120 REM
130 REM 9T9ER USERS GROUP, T
ORONTO
140 REM The word INSTRUCTION
S in line 160 may be changed
to any word in the resident
vocabulary for different ef
fects
150 FOR Y=1 TO 88 :: IF Y=4
THEN Y=7
160 CALL SPGET("INSTRUCTIONS
",D$)
170 D=LEN(D$):: PRINT Y
180 D$=SEG$(D$,1,2)&CHR$(D)&
SEG$(D$,Y,D)
190 FOR X=1 TO 6 :: CALL SAY
(,D$):: NEXT X :: NEXT Y
```

User Notes is a column of tips and ideas designed to help readers put their home computers to better use. The information provided here comes from many sources, including TI home computer user group newsletters. MICROpendium will pay \$10 for any item sent in by readers that appears in this column. Mail tips to: MICROpendium, P.O. Box 1343, Round Rock, TX 78680.

## TUTORIAL—

(Continued from Page 35)

Bits 1 and 2 of all bytes indicate the tone generator: 00 is generator #1. 01 = #2. 02 = #3. 11 = noise.

**Frequency vs. Frequency Code**  
The frequency code is defined as half

the period of the specified frequency. Here's the formula:

$$\frac{111860.8}{\text{Frequency}} = \text{Frequency Code}$$

(Please turn to Page 45)

## HOME ON THE RANGE—

(Continued from Page 35)

```
BYTE >03,>82,>0E,>91,40
BYTE >03,>8E,>0F,>91,40
BYTE >03,>80,>0A,>91,40
BYTE >04,>A0,>0A,>9F,>B1,40
BYTE >06,>80,>0A,>AD,>10,>93,>B3,60
BYTE >04,>80,>0A,>91,>BF,20
BYTE >04,>A0,>0A,>9F,>B1,40
BYTE >09,>8A,>0A,>A6,>0D,>CD,>11,>95,>B5,>D5,50
BYTE >05,>8E,>0B,>91,>BF,>DF,30
BYTE >03,>86,>0D,>91,40
BYTE >09,>82,>0E,>AD,>11,>CD,>17,>95,>B5,>D5,40
BYTE >05,>86,>0D,>91,>BF,>DF,40
BYTE >03,>8E,>0B,>91,40
BYTE >03,>86,>0D,>91,100
BYTE >01,>FF,0
END
```



## TUTORIAL—

(Continued from Page 44)

Example: To find "middle C," which has a frequency of 523.25,  $111860.8/523.25 = 213.8$ . This rounds to 214 or >D6. Bits 0-5 are placed in bits 2-7 of the second specification byte. The four least significant bits of the frequency code are placed in bits 4-7 of the first specification byte. Example: To enter a tone of 392 Hz in generator 1; this equates to a frequency code of 285 or >11D.

1000 XXXX 00XX XXXX = >8---

Here we have selected generator 1. Now we take our frequency code 11D and place its four least significant bits (>D) in bit position 4-7 of the first specification byte:

1000 1101 00XX XXXX = >8D--

Finally we take the most significant six bits of the frequency code (>11) and place them in bit positions 2-7 of the second specification byte:

1000 1101 0001 0001 = >8D11

We have created the first two specification bytes to generate a tone on generator 1.

#### Volume Specification Byte

Volume is held in bits 4-7 of the third specification byte. It can range from 0 to 30. The 0-3 bits contain the generator number. You must pad the volume on the right with 0 always. For example: A volume of 0 on generator 2 = 1011 0000.

#### Duration

Not a specification byte. How long the tone or noise will last. Measured in 1/60 of a second. Can be from >00 to >FF.

#### Loading the Sound Table

You must indicate the number of specification bytes you are going to feed the sound generator. For example:

>03,>89,>3F,>91,30

>03 indicates three specification bytes. Second and third bytes mean generator 1 with a tone of 110 Hz. The fourth byte sets the volume at 2 on generator 1. The 30 indicates 30/60 of a second duration.

Provided is a table for generating tones quickly.

So go FORTH and make music!

NEW! FROM THE CREATORS OF BANNER '99 AND EXTENDED BUSINESS GRAPHS:

# JOY PAINT '99

(C) Copyright 1986

After months of careful planning JOY PAINT '99 is finally available. This all new 100% assembly language program features graphic capabilities found in no other software application. Use JOY PAINT '99 to create signs, charts, diagrams, advertisements, or graphics of any type. JOY PAINT '99 is sophisticated, yet simple to use. In fact, the user never needs to touch the keyboard; all functions are joystick controlled. There are no complicated function keys to remember, just simple on-screen tools like a PENCIL, ERASER, PAINT BRUSH, and SPRAY CAN, just to name a few! JOY PAINT '99 allows circles and ovals to be drawn with incredible speed and precision. Lines, boxes, and rectangles can also be quickly drawn! Additionally, the FILL, PAINT BRUSH, and SPRAY-CAN tools allow filling and painting in any one of 26 selectable PATTERNS. These patterns are re-definable and add the dimension of 'texture' to your graphics. JOY PAINT '99 also features 8 re-definable brush shapes!

A 'pull down window' contains many more features that make creating and manipulating graphics fun and easy. Any object can be INVERTED, ROTATED, FLIPPED VERTICALLY or HORIZONTALLY, COPIED, MOVED, or stored on a CLIPBOARD FILE. A magnify feature allows graphics to be increased. A ZOOM OPTION called FATPIXELS, allows fine single dot editing.

JOY PAINT '99 also contains dozens of features not found in any other graphics application. For instance, an 'UNDO' feature, that instantly 'TAKES BACK' the last portion of work the user performed! Its DIRECTORY feature can CATALOG your diskettes! JOY PAINT '99 CONSERVES DISK SPACE, by not saving the redundant blank areas in your graphics! Printouts can be made directly from within the program, in normal or double size, and in single or double density!!

JOY PAINT '99 features a 'drawing area' that is 92% larger than that of any other graphics program. The screen is actually a 'window' through which the user views a much larger graphics page!

REQUIRES: TI-99/4a, 32K, Disk Drive, Joy Stick, and one of the following: Extended Basic, Editor Assembler, or Mini-Memory.

Epson compatible printer is optional. (soon other printers too!)

Be among the first to experience this unique and practical program; Order yours Today! .....\$49.95 POSTPAID.

\*\*\* COMING SOON: JOY PAINT COMPANION! \*\*\*  
With font editor and hundreds of pre-designed graphics

**Great Lakes Software**  
804 E. Grand River Ave.  
Howell, MI. 48843

THIS ADVERTISEMENT WAS CREATED USING JOY PAINT '99!

## Support our advertisers

# Classified

## Policy

Classified advertising is a unique feature of MICROpendium. The cost is 20 cents per word. Classified advertisements must be paid in advance. Classified advertisers may request a category under which they would like their advertisement to appear, but the final placement decision is the responsibility of the publisher.

Classified deadlines will be kept open for as long as practical. For the purpose of classified advertising deadlines, any classified ad received later than the first day of any month cannot be assured of placement in the next edition. We will do our best to include every advertisement that is submitted in the earliest possible edition.

The publisher offers no guarantee that any advertisement will be

published in any particular issue. Any damages that result either from errors in copy or from failure to be included in any particular edition will be limited to the amount of the cost of the advertisement itself. The publisher reserves the right to reject any advertisement.

The advertiser may elect to publish the advertisement in subsequent editions at the same charge, payable prior to publication. The deadline for carryover classifieds is the same as for new advertising.

In submitting an ad, please indicate whether you would like a refund if it is not published in the requested edition or whether you would like us to hold it for the next edition. Cancellations and refunds cannot be made after the second day of the month.

Send classified advertising to: MICROpendium, P.O. Box 1343, Round Rock, TX 78680.

## Software for Sale

### TI99/4A SOFTWARE

140 programs available, only \$3 each! Not public domain, not translations, not pirated, not brief routines, these are absolutely original, innovative programs utilizing full color and sound capabilities of the TI99/4A. Games, education, music, displays, programmers' aids, etc. Catalog \$1, refundable. Tigercub Software, 156 Collingwood, Whitehall, OH 43213. v3n2

### NUTS & BOLTS

A diskfull of 100(!) utility subprograms for the TI99/4A in XBASIC MERGE format, ready to merge into your programs. With documentation, just \$19.95 postpaid! And now ready, NUTS & BOLTS -2, another diskfull, another 100 subprograms, also \$19.95, or both for \$37 ppd. Tigercub Software, 156 Collingwood, Whitehall, OH 43213. v3n5

### TIME TRAVEL

Display a single month or an entire year on the screen from 1600 to 2100. Year search feature plus optional output to printer. Includes an integrated 125-question history trivia quiz in multiple choice format. XB, disk, 48K required—\$5 ppd. Buy both for \$8 ppd and get two original bonus programs—MATHGAMES and STATES/CAPITOLS. Send check or M.O. to NAMELOC, 3971 S.E. Lincoln, Portland OR 97214. v3n1

### RMJ 1985 TAX PROGRAMS

Enter the data requested and the computer will give you a printout on your printer or the screen of what to put on the various forms and schedules. Requires Extended BASIC, 32K Expansion, and Disk Drive.

Form 1040 and Sched A	\$12.95
Form 1040A and Sched 1	\$8.95
Schedule B	\$4.95
Schedule C	\$4.95
Schedule D	\$5.95
Schedule E	\$5.95
Schedule W	\$4.95
Form 2441	\$4.95
All of the above	\$39.95

Send Certified Check or Money Order to: RMJ Home Computer Sales, 2982 Whileaway Cir. W., Colorado Springs, CO 80917 v3n1

### SIM::WIN PROGRAMS

TI X-BASIC games and programs, such ones as TREASURE DIVE. For catalog send 25¢ or SASE to: Sim Win Computer P.O. Box 1325, BEAVERTON, OR 97075-1325 v3n1

**ATTENTION PROWRITER AND EPSON compatible printers—CHARACTER SETS AND GRAPHICS DESIGN I**, as reviewed in the May 85 MICROpendium, includes 10 character fonts for only \$17.95. CHARACTER SETS AND GRAPHICS DESIGN II includes 8 character fonts, a BANNER program that uses all fonts and a choice of 65 graphics (uses an assy language routine for fast printer output) for only \$12.95. SCREEN IMAGE DUMP VS2 is 100% assembly language and features normal and

double size dumps, invert video, single keystroke dump at any time in program, starting and ending screen line and tab spacing for only \$16.95. All programs require Disk system, Memory Expansion, and compatible 8 bit dot addressable graphics printer. CSGDI and CSGDII require Extended BASIC while SCREEN IMAGE DUMP requires either Extended BASIC, Mini-Memory or Editor/Assembler. Please enclose PRINTER NAME when ordering or send for more information to DAVE ROSE, 2781 RESOR ROAD, FAIRFIELD OHIO 45014. v3n3

### LABELMAKER

Print labels the way you want! Offers you 5 lines (fields)/label and 4 line lengths and fonts (17 to 56 chars/line); centered or left-justified, one or as many as you like. Built-in mailing list feature allows you to build, fully edit, store, and load a list; sort it on any of the 5 fields, then print out on labels. XB, disk, 48K, Epson-compatible printer required—\$5 ppd. Leroy Enterprises.

**FOR SHAKLEE SALES LEADERS, COMPLETE software system, \$400.00.** For more information: Leroy Enterprises, 6814 Vivian Avenue, Dallas Texas 75223, (214) 327-7021. v3n1

**ROCKETMAN CHECKBOOK PROGRAM and THE BASIC DATA BASE PROGRAM:** Start business organization with the basics, keep your bank accounts balanced to the penny. The ROCKETMAN CHECKBOOK PROGRAM is a great aid for those long difficult accounts.



# Classified

Cost—\$39.95 diskette, \$24.95 for cassette. The BASIC DATA BASE is a separate program which will store all tax deductible items to random access files and print hard copies when needed. Cost—\$9.95, diskette only. Disk programs require Extended BASIC, 1 disk drive and 32K expansion. CALIFORNIA PROGRAMS, 4104 San Pablo Dam Rd. El Sobrante, Ca. 94803. 415-222-1626—California residents add 6.5% sales tax. Visa or MasterCard accepted. v3n1

## SOFTWARE FOR SALE

Business, data and game programs available on cassette or disk. Extended BASIC required. Free catalog. (513)825-6645. Extended Software Co., 11987 Cedar Creek Drive, Cincinnati, OH 45240. v3n2

## PRK DATABASICS

PERSONAL AUDITOR V4.0, the professional home finance management application appearing in past issues of MICROpendium, is available once again, now with new enhancements and seven powerful utility programs to help you manage your finances. Our BUSINESS AUDITOR V1.0 is also available to meet small business needs. Both applications provide easy, menu-driven access to your finance data.

MASTER MENU offers 14 different, unprotected, user-modifiable menus employing some really interesting programming techniques.

PERSONAL or BUSINESS AUDITOR (32K, disk, XB. req.) \$29.95. MASTERMENU (disk, XB req.) \$14.95. Fully documented. Add \$2/order S/H.

PRK DataBasics Box 2642 Grand Junction, Co. 81502 v3n1

## TEACHER'S AIDE

is an advanced grade-management system for the TI99/4A. This program allows you to define your own weighted grading criteria. You may display students' grades and averages on screen or, in eighty column format, to a printer. There are three easy ways to enter grades. Grades may be curved automatically in two ways—bell curve

or by straight point addition. You can even print progress reports! These reports contain all relevant grades and averages as well as (optional) comments. Disk system, 32K memory, Extended BASIC required (printer optional). 30 day UNCONDITIONAL money back guarantee. Send check or money order for \$15.50 + 1.50 shipping and handling to JSTI Software 70 Stanson Dr. N. Attleboro, MA 02760. Further information available. v2n1

## SUPERBUG II

The features of TI's Debugger and Super Debugger have been combined, debugged, and enhanced. New features allow you to change output device and screen colors. A version for loading into SUPER SPACE memory is included along with a 40-page manual. Send \$10.00 to Edgar Dohmann, Route 5 Box 84, Alvin TX 77511. v3n3

## TI-99/4A CHRISTIAN SOFTWARE

BIBLE BOOKS GAME, Have fun learning OT/NT, Hallelujah!, Hundreds of clues, 9 game levels. Send \$19.95 for cassette or \$1.00 (refundable) for more information to: TRINITY SYSTEMS, Dept. M, 1022 Grandview Ave., Pittsburgh, PA 15237 v3n2

## GEMINI/EPSON OWNERS—CONTROL

your printer, avoid printing through page perforations or punching holes in your line numbers. This program allows setting of margins, print pitch, perforation skip, etc. TI-99/4A BASIC listing—\$2.00, cassette—\$4.00, Disk—\$6.00 PPD. John C. Roberts, 419 Branscomb Road, GCS, FL 32043 v3n2

## TIPS FROM TIGERCUB

Full disk of 50 programs, routines, files from the well-known Tigercub Tips newsletters #1-#14, \$15 postpaid. Tips Vol. 2 diskfull of 64 programs, files from newsletters #15-#24, \$15, or both for \$27 postpaid. Tigercub Software, 156 Collingwood, Whitehall OH 43213 v3n5

**18 ORIGINAL EXTENDED BASIC PROGRAMS.** Half of these once sold for over \$30! Send 2 diskettes, postage, & \$5.00 or simply \$8.00 to T&T Software, 109 Tee Circle, Salem, VA 24153 v3n1

## Hardware

### 32K MEMORY SALE

Brand new standalone memory module, smaller than speech synthesizer. Six month warranty. Limited quantity. \$50.00 ppd. Check, MO, MC, Visa. Tachyon Systems, 5125 S. Westwind Way, Salt Lake City, UT 84118. 801-488-3527 v3n1

### P-CODE CARD, COMPLETE SOFTWARE

Manuals. \$175.00. Wally Barabash, Box 862, Edmonton, AB, Canada T5J 2L8. (403) 466-6401. v2n1

### MUST SELL!!! TI99/4A COMPLETE

system; New Gemini 10X printer; Like-new monitor; 128 memory card; modem; software included; Must call or write for more information!!! \$1200.00 obo. Z80 Foundation card new in box \$280.00. Ahmad Kauser, 3965 South Normandie #3, Los Angeles, California 90037 (213) 292-9367 v3n1

## Miscellaneous

### TI 99/4A GENERAL SUPPLIES

**Hardware ★ Software ★ Accessories  
Retail Store ★ Full Mail Order Service**

We carry a full line of TI computer supplies. Call or write us for information and to join our Mailing List—Free

**\* VISA & Master Card Welcome \***

**No Extra Charge**

**No Handling Fees!**

**For Mail Order Services**

**Factory Authorized**

**Star Printer Service**

**Pilgrims' Pride Hatboro, PA 19040**

**5 Williams La (215) 441-4262**

**Knowledgeable Service**

**Willing Support**

v3n2

# The LEADING monthly devoted to the TI99/4A

## Subscription Fees

\$15 for 12 issues via domestic third class mail  
 \$18.50 for 12 issues via domestic first-class mail  
 \$18.50 (U.S. funds) for 12 issues Canadian delivery  
 \$21.50 (U.S. funds) for 12 issues foreign delivery via surface mail  
 \$35.00 (U.S. funds) for 12 issues foreign delivery via air mail  
 (Texas residents add 77 cents sales tax)

## Address Changes

Subscribers who move may have the delivery of their most recent issue(s) delayed unless MICROpendium is notified six weeks in advance of address changes. Please include your old address as it appears on your mailing label when making an address change.

## Back Issue Policy

Back issues of MICROpendium are available to subscribers only. Those wishing back issues may notify us of the issue(s) desired and include \$1.35 per issue desired in a check or money order. (U.S. and Canada; Texas residents add 5.125% sales tax.) For foreign airmail delivery, add \$2 per issue, 50 cents per issue surface mail. All prices listed are U.S. funds.

Send me the next 12 issues of **MICROpendium**. I am enclosing \$ \_\_\_\_\_ in a check or money order in U.S. funds (Texas residents add 77 cents sales tax.) Mail to: MICROpendium, P.O. Box 1343, Round Rock, TX 78680

Name \_\_\_\_\_

Address \_\_\_\_\_

City \_\_\_\_\_

State \_\_\_\_\_ ZIP \_\_\_\_\_

v3n1

## Time to RENEW?

Readers who are interested in renewing their subscription to MICROpendium without missing a single issue must do so before their current subscription expires.

At right is a facsimile of a typical mailing label attached to the front of subscriber copies.

The upper line includes information about the month the subscription was entered and the number of the first issue the subscriber received. An asterisk included indicates that the expiration number will be in 1986 (1987 if S1\*), a caret that the expiration number will be in 1987. Renewals changing from third to first class mailing will not have the code changed until the month the first class mailing begins.)

When renewing subscriptions, please include a copy of a mailing label or write out the codes that appear on the label.

A128452 105  
 JOHN SMITH  
 1324 ELM ST.  
 PEORIA IL 60001

### Code description

Refers to status of subscription. "A" means active.  
 The combination of the next four numbers refers to the month and year the subscription was actually entered.

The next 2-4 characters represent the type of subscription and the number or initial of the month of the year the subscription started. "S" means subscriber. Refer to the following definitions for the issue your subscription started:

2=February	6=June	0=October
3=March	7=July	N=November
4=April	8=August	D=December
5=May	9=September	1=January

Our subscription year runs from February to January. In other words, our first edition of any year will be the February edition. The last edition of any year will be the following January's edition.

## PDM—

(Continued from Page 39)

value grade to this program. The product should be viewed as a kind of insurance policy on one's computer. If nothing goes wrong with the computer, this module will see a lot of shelf time. If one's computer does malfunction, it could be of some assistance.

The value of this program is lessened by the fact that the Disk Manager module already has disk tests. Indeed, the Disk Manager read/write tests are more complete than the PDM tests since they write to and read from all sectors on a disk rather than just 32.

The PDM test is faster, but if something has gone wrong with one's system, the extra few minutes will not be vital. For those with double-sided disk controllers this caveat does not apply, since the Disk Manager does not support double-sided format. (TI Disk Manager II does support double-sided, double-density disk controllers-Ed.)

While possible causes of errors are listed for the disk tests, these are often of little help. Many of the errors have possible causes that include defective drive, defective controller and defective diskette. This does not provide

much help. I am not blaming Cor-Comp for this—in many cases it is not possible to narrow it down further. Still, this fact must be considered when assessing the product's value.

One final factor to consider is price. \$24.95 seems to me to be rather steep for a module that will most likely receive little use.

The value grade that I gave this product is highly subjective. The final decision on whether to buy will depend on how much one is willing to spend for "insurance."