

# portable 100

TANDY LAPTOP COMPUTING VOLUME 3 NUMBER 12 AUGUST 1986



The Expense Manager:  
A Traveler's Best Friend

14470-17159

Did you think we were content to stop with the **ULTIMATE ROM?**

Introducing . . .

# THE ULTIMATE ROM II

**We set the standard!** With the Ultimate ROM, Traveling Software set the standard for packing the most powerful software into a ROM chip. Now, with the Ultimate ROM II, we're setting new standards.

Five  
applications  
on one chip!  
Only  
**\$229.85**

Five applications that occupy only one file position on your laptop computer!

■ **ROM-View 80** displays up to 60 characters per line — 80 characters with scrolling — instead of the usual 40. Can be used in all Ultimate ROM II applications as well as TEXT, TELCOM, and BASIC. Lets you create your own BASIC programs using an 80-column display. (ROM-View 80 is not available for the Tandy 200. The complete TS-DOS disk-operating system is included in its place.)

■ **T-Word** provides search and replace, overwrite, word count, hanging indentation, headers and footers, conditional paging, right justification. Fast text formatting by menu and by control codes. Provides three ways of previewing documents before printing, including a pixel page plot. Supports virtually all types of printers with such features as bold-face, underline, condensed print. Merges everything from single words to complete files.

■ **IDEA!** organizes anything from simple lists to complex outlines, allowing easy reorganization, sorting and searching. Includes many database and word processing capabilities. New on this version: faster operation, a preview mode, and a template-generating feature. With LAPDOS, its files can be exchanged with ThinkTank files.

■ **T-base** lets you design true relational databases, borrow information from seven other files, set up formulas for calculations. New on this version: faster operation; floating decimal; calculation of sines, square roots, etc.; conditional and logical calculations. T-base files can be exchanged with desktop programs like dBASE II and III, R:base 5000 and WordStar MailMerge.

■ **Portable Disk Drive Support**, provided by a subset of the TSDOS, lets you print and preview files directly from disk without loading them into your computer. With disk files, allows all of the merge operations possible with RAM files.

Check out the **ULTIMATE ROM II** at your local Radio Shack computer center today or to order direct, call us toll-free:

If you are not satisfied with other ROM software you have purchased, call us about our \$100 trade-in allowance.

The Ultimate ROM II is simply the best ROM software you can buy for your computer, just ask somebody who owns one!

Circle 72 on Reader Service Card

Now Includes  
80-Column Display  
in TEXT, TELCOM, and BASIC

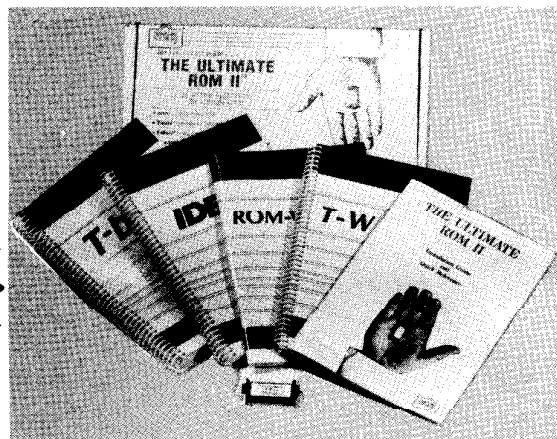

## The Ultimate ROM II

for the Tandy 100/200  
NEC PC-8201

### Five Applications:

■ **ROM-View 80:** Full text editing in up to 80 columns (not available for the Tandy 200)

■ **T-Word:** An easy-to-use word processor with considerable functionality

■ **IDEA!** The best-selling outline processor for laptop computers, in a faster, more powerful version

■ **T-base:** Rated as the best database for the Tandy and NEC portable computers, now faster and even more powerful

■ **Portable Disk Drive Support:** Built-in support for the Tandy and Brother portable disk drives

**Requirements:** A computer with at least 16K of RAM; printer optional.

**30-Day Guarantee:** Order the Ultimate ROM II today. If you are not completely satisfied, return it within 30 days, and we will refund your money — no questions asked.

**1-800-343-8080**



Traveling Software, Inc.  
11050 Fifth Avenue, N.E.  
Seattle, WA 98125  
(206) 367-8090



# THE BARRIERS ARE BROKEN!



## TS-DOS™

For

TANDY MODELS 100/200 and NEC PC-8201

## LAPDOS™

For

IBM PC, XT, AT and COMPATIBLES

## THE FIRST BARRIER

The Tandy portable disk drive is an amazing little 1 3/4 pound disk drive that operates on 4 AA batteries. And what is even more amazing is that it costs only \$199. But one thing missing is a true operating system to unleash the power of this product. Without TS-DOS, the Tandy disk drive is a nice and fast replacement for a cassette recorder. With TS-DOS, this disk drive turns your laptop computer into a real powerhouse that can be accessed easily and directly from any BASIC program.

TS-DOS LOOKS EXACTLY LIKE YOUR regular files menu, but now you can do such things as save the complete contents of your computer to disk at once, create files up to 100K in size with the append function, or even view the contents of a disk file without having to transfer it into your computer first. And TS-DOS only occupies 400 bytes when not in use. While using TS-DOS, you will need only 2-4K.

TS-DOS is only \$69.95. If you own the Ultimate ROM II, or are purchasing it now, you can get TS-DOS at a \$20 discount. TS-DOS comes on a 3 1/2" disk and works automatically with the Ultimate ROM II or can be initially loaded using FLOPPY.CO with the Tandy Models 100/200 or by using a cassette drive with the NEC PC-8201.

## THE SECOND BARRIER

Until now, the Tandy and NEC laptop computers were not easily used with IBM desktop computers. Traveling Software has broken this barrier with a product called "LAPDOS," which allows the Tandy portable 3 1/2" disk drive to be plugged into and used with any IBM PC or compatible with a serial port. LAPDOS can be operated as a RAM-resident utility on your IBM, which means you can call it up with two keystrokes while using your favorite word processor, spreadsheet, or other software. You could be in the middle of Wordstar, for example, and read in any text files from your portable disk drive.

LAPDOS allows you to easily use your database, spreadsheet, or word

processing files while on the road with your Tandy or NEC laptop computer. In fact, LAPDOS includes a program called "The Exchanger" which allows you to use ThinkTank and Sidekick files with the IDEA! outline processor available from Traveling Software on a software chip called The Ultimate ROM II.

LAPDOS is only \$89.95, which includes a special hardware adapter which allows the disk drive to plug into any IBM PC or compatible computer with a serial RS232 port. The LAPDOS software comes on an IBM 5 1/4" disk with a complete owner's manual. And if you already own the Ultimate ROM II, or are purchasing it now, you will receive a \$20 discount off the cost of LAPDOS.

**ORDER FORM**

TO ORDER BY PHONE CALL TOLL FREE  
1-800-343-8080 or (206) 367-8090

### LAPDOS System Requirements:

128K IBM PC or 100% compatible computer, with a RS232 serial port

Name _____	Shipping: \$6.00
Shipping Address _____	Subtotal: _____
City _____	(WA res. add 7.9% sales tax)
State _____ Zip _____	Amount Enclosed _____
Telephone _____	Payment: VISA MC COD Check
Please rush me:	Credit Card Exp. Date _____
_____ copies of LAPDOS @ \$89.95	Card # [ ] [ ] [ ] [ ] [ ] [ ] [ ] [ ] [ ] [ ] [ ] [ ]
_____ copies of TS-DOS @ \$69.95	Card # [ ] [ ] [ ] [ ] [ ] [ ] [ ] [ ] [ ] [ ] [ ] [ ]
	Written company purchase orders will be accepted

TRAVELING SOFTWARE, INC.  
11050 FIFTH AVENUE NE  
SEATTLE, WA 98125

© 1986, Traveling Software, Inc.

Traveling Software and the Traveling Software suitcase logo are registered trademarks of Traveling Software, Inc. Other trademarks:

ThinkTank - Living Videotext, Inc., Sidekick - Borland International

Circle 58 on Reader Service Card

*Editor*

J.D. Hildebrand

*Senior Editor*

Park M. Morrison

*Technical Editor*

Alan L. Zeichick

*Assistant Editor*

Eva P. Thompson

*Contributing Editor*

Carl Oppedahl

*Production Director*

Peter D. Koons

*Art Director*

Paige Garland Parker

*Assistant Art Director*

Elizabeth Maritato

*Staff Artists*

Barbara A. Peakes

Judith E.C. Webster

*Marketing Director*

James W. McBrian, Jr.

*Advertising Director*

David Hollis

*Circulation Director*

Nancy A. Wight

*Circulation Manager*

Loriel Peters

*Subscriber Relations*

Mary M. Holmes

Lisa M. Jimenez

Catherine P. Sexton

*Business Manager*

Henry H. Leigh

*Business Services*

Kathleen McLaughlin

*MIS Director*

Bonnie Hellevig

*Publisher*

Carl Cramer

*Director, Magazine Development*

Kerry Leichtman

*Editorial and Business Offices*

Highland Mill, P.O. Box 250

Camden, ME 04843

(207) 236-4365

PORTABLE 100, published monthly by Camden Communications Inc., Highland Mill, P.O. Box 250, Camden, ME 04843. Second class postage paid at Camden, ME and additional mailing offices. Postmaster: Address changes to PORTABLE 100, Camden Communications Inc., Highland Mill, P.O. Box 250, Camden, ME 04843. Copyright 1986 by Camden Communications Inc. All rights reserved. PORTABLE 100 is an independent publication of Camden Communications Inc. and is not affiliated in any way with Tandy Corp./Radio Shack. TRS-80, Model 100, Tandy, Tandy 200 and Tandy 600 are trademarks of Tandy Corp./Radio Shack.

Contributors: Manuscripts and photographs are welcomed. Publisher assumes no responsibility for the return of unsolicited manuscripts, queries or artwork.

Subscriptions are \$32 for 12 issues. User group subscription rates available. Please inquire for delivery rates outside the U.S. Dealer inquiries invited.

ISSN 0738-7016

## ROM WITH A VIEW

# Why Change a Good Thing?

About a month after I started working here, that would be September 1985, rumors started circulating about a new portable computer that would replace Tandy's Model 100. Not much was known about it. It was anybody's guess as to what the new computer would feature — and just about everybody took a shot.

Predictions ran the gamut from a new LCD to bigger memory to an improved keyboard. There were even rumors of rumors that it would have some kind of electronic gadgetry that would make the Pentagon stand up and take notice. Speculation ran rampant for a couple of months.

Then nothing. The rumors died down and were relegated to the lowly distinction of, well, rumors. People were too interested in tangible things like disk drives and multi-ROMs to bother with fictional computers. Besides, they were happy with their Model 100s. Why would Tandy want to change a good thing?

In April of this year I was down in Fort Worth for the Tandy Computer Business Users Group (TCBUG) annual get-together. In the midst of a predominantly Tandy 6000/Xenix audience, it was announced that indeed a new portable, the Tandy 102, would be introduced. There was no marching band, no hoopla, no rockets' red glare. At the time, the general feeling was it would be available in stores sometime this summer.

"So what does the new portable feature?" I hear you ask.

Well for one thing, it's thinner.

"Yes, yes and what else?"

It's about a half pound lighter.

"Yes, yes and what else?"

The system bus is on the back of the computer, like the Tandy 200, instead of on the bottom.

"Yes, yes, tell us more."

More? There isn't any more. That's it. That's the deal. Oh yeah, it costs \$499. Otherwise, it's identical to the 100. Software, keyboard, screen — all the same. Tandy's reasoning: Why change a good thing?

With the introduction of the Tandy 102, we here at *Portable 100/200/600* were faced with a dilemma. What does that make us? *Portable 100/102/200/600*? The thought of rolling that off his tongue with every sales call made our ad director cringe.

Our quandary was short-lived. It didn't take us long to decide that the name of this publication, now and forever, should be *Portable 100* — in honor of Tandy's torchbearer. As the name implies, it's the magazine for users of all Tandy laptop computers. Not only that but it's easier to say.

To accommodate the name change, we altered the logo slightly. Following Tandy's lead, we made the "portable" a little thinner, took off a good half pound (by dropping 200/600) and put the 100 on the same line (since we couldn't very well put it on the back).

The look is new, but the product is the same. We'll still be coming to you each month filled with the best programming articles, product reviews, hardware projects and application stories for and about your portable. After all, why change a good thing?

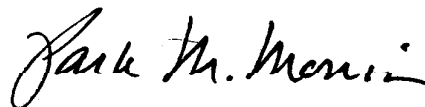

Park M. Morrison  
Senior Editor



# POWR-DOS

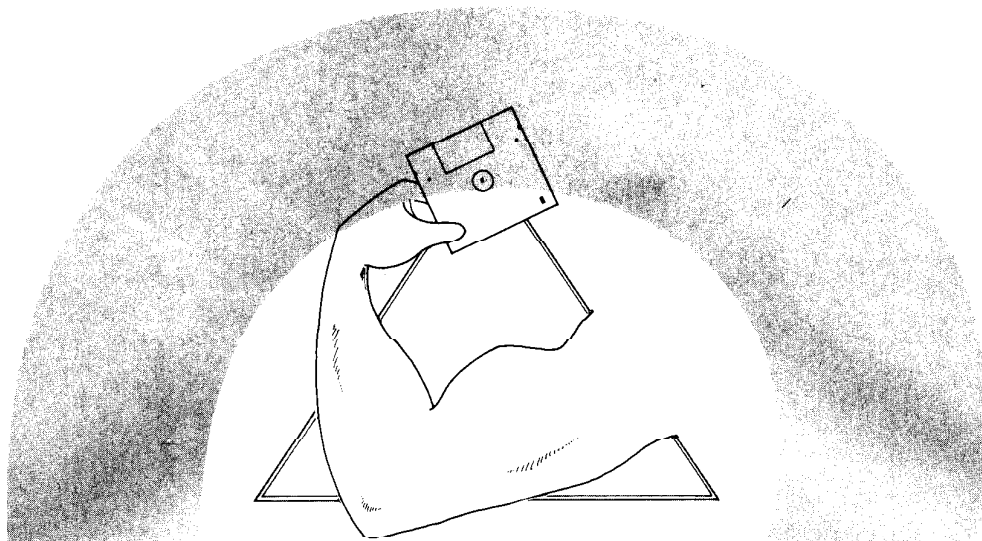

Eight months ago, we began selling POWR-DISK, the first software to give access to the Tandy Portable Disk Drive from Model 100/Tandy 200 BASIC and TEXT. Response was enthusiastic. Today, POWR-DISK still offers a great value in Disk-Drive software. But if you want *real* power for your Drive you want POWR-DOS.

POWR-DOS is a second generation product. We took dozens of suggestions from our POWR-DISK customers and created a POWR program that truly transforms your laptop computer. Check out these second-generation features:

<b>POWR-DISK feature</b>	<b>POWR-DOS enhancement</b>
Access to Disk from TEXT	Software allowing you to PRINT and EDIT files too large to fit into RAM: <b>up to 64K!</b>
A MENU program to move files between RAM and DISK	An entire <b>family</b> of menu programs allowing you to select the combination of features you need, with minimum RAM required!
Sequential Access to Disk files from BASIC programs	<b>Random Access</b> to disk sectors using special BASIC commands!
A relocater package allowing compatibility with <b>most other software</b>	A new loading method that is <b>automatically compatible</b> with virtually any other software package!

Some POWR-DOS features are totally revolutionary, such as a "swapless" backup from disk to tape, a machine-language management program, and a "disaster recovery" program that allows you to recover data from "trashed" disks. There simply isn't space here to cover all of the improvements and new features.

Step up to second-generation POWR! Order POWR-DOS today, or call or write for more information. (We've already written our POWR-DISK customers about our upgrade policy; if we missed you, please contact us.)

## **POWR-DOS** by Acro•atix

\$69.95 + \$3.00 Shipping

Acro•atix Incorporated  
10 Upton Drive  
Wilmington, MA 01887

Phone orders call:

**1-800-225-5800**

Technical inquiries call:

**1-617-658-5550**

# Second Generation POWR



# 6 ROM

# BANK

plus powerful Nicad battery pack that gives 30 hours of power to your Model 100



**Now only \$199**

A joint PCSG/CRYPTRONICS project.



Now you can access LUCID, DISK +, WRITE ROM, RAM+ and others instantly.

The 6 ROM BANK plus battery pack lets you have the ultimate Model 100 system. When you get your unit just press in up to 6 ROMs into the sockets then push in a simple plug into your Model 100's ROM socket. The ROM bank has two posts on either end that insert into the two little holes on the underside of your Model 100.

The ROM bank props up the Model 100 at the same angle and height as those little legs you've seen. The ROM BANK itself is only about 1 1/2" deep and it runs the width of your Model 100. It only weighs one pound. It not only installs instantly, but it pops free in a second if you need everything to lie flat in a briefcase.

Change from ROM to ROM with the touch of a thumb switch.

You can go from LUCID to WRITE to DISK+ to any other ROMs just by turning the thumb switch at the side of the ROM bank. The 6 ROM BANK is a sturdy well built construction that looks like it is a part of your Model 100.

What is also fantastic is that the ROM bank has a powerful NICAD battery and recharger built right in. This power source supplies up to 30 hours of life to your Model 100 with just 6 hours of recharge. What's nice is that it recharges right from your Model 100's power adapter. This is a quick charge system and if you need power in a hurry, you can get 6 hours of life for your Model 100 by just charging for an hour and half.

Suddenly, the Model 100 is a very powerful computer.

If you have the HOLMES portable disk drive with its powerful bundled database software package or the CRYPTRONICS 128K RAM expansion along with LUCID, WRITE ROM and DISK+ in the 6 ROM bank with its rapid rechargeable NICAD power source, you have the ultimate portable system. It's all available only from PCSG.

As usual we don't want you to take our word for it. The 6 ROM BANK is sold on a 30 day trial. If you are not satisfied simply return within thirty days for a full refund. MC, VISA, AM, EX, or C.O.D.

**1-214-351-0564**

PORTABLE COMPUTER SUPPORT GROUP

11035 Harry Hines Blvd. No. 207 Dallas, Tx 75229  
VISA / MASTER CARD / AM. EXP. / C.O.D.

Circle 32 on Reader Service Card



# portable 100

AUGUST 1986

VOLUME THREE, NUMBER TWELVE

## ON THE COVER

### KEEPING TRACK .....27

A proven business expense manager goes public. Here's a simple program for keeping tabs on tabs.

Cover photograph by Benjamin Magro

## ARTICLES

### A KEY TO FILE MANAGEMENT .....12

Here's a utility to help you organize your random access memory and tape files.

### CALCULATING YOUR COSTS .....22

A spreadsheet for generating a bill of materials.

### THE POWER OF LIGHT .....30

Is it on? Is it off? A do-it-yourself solution to a portable disk drive problem.

### LAPTOP GENEALOGY .....34

You can research your family tree without purchasing any special software. An outline processor works just as well.

## REVIEWS

### THE BRIDGE OVER THE RIVER DOS .....15

Traveling Software's LapDOS

### SPEED IS THE GAIN .....19

MinSof's Fast

## DEPARTMENTS

### ROM WITH A VIEW .....5

### GIGO .....6

### NEW PRODUCTS .....10

### AD INDEX .....41

### YOU BE THE EDITOR .....41

### MAXRAM .....62



# Attention Subscription Department

Let me begin by saying I've never seen a magazine so dedicated to providing the best product reviews, technical articles and general information on a single consumer item as does *Portable 100* for the Model 100. I've maintained a library of magazines for several years and yours is by far the most informative on the market today. The practice of allowing users like myself the opportunity to offer comments and reviews is by far easier to comprehend than trying to wade through the technical jargon many engineers use to describe a product. Your technical articles are useful to the common user as well as being explicit and to the point.

It's because of all the reasons I've just listed that I've chosen not to renew my subscription. As illogical as this may sound, it will be better for me. As for why, let me explain.

First and foremost, the arrival of my issue in the mail is usually followed within one week the arrival of next month's issue at my local newsstand. For example, I received my April issue on April 21, six days before the May issue was on my newsstand's counter. I realize that my subscription fee in no way can compare to the cover price but I'd like to get my copy at least within the same week as the store.

Secondly, the past few issues have arrived in less than satisfactory condition. The April issue in particular arrived with the cover tattered and torn. The last ten pages looked like they had gotten wet. To me, it's worth paying the extra money to purchase a good clean copy at my local magazine vendor.

Finally, I must say your May issue (which I bought at the newsstand) is the best I've seen since I've been collecting *Portable 100*. All the utility articles were useful, the technical article, "Calling All Peeks and Pokes" was very educational and the reviews on Super ROM and Power-Disk were accurate and detailed.

I wish to thank you for publishing such an instructional and enlightening magazine and hope that my purchasing copies at the newsstand will work

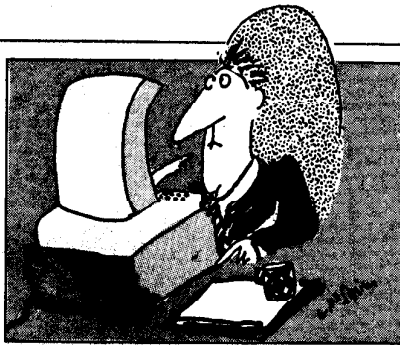

to your advantage by paying the higher price. If you ever go to a protective cover and timely subscription shipments then I'll be more than glad to re-subscribe. Thank you very much and keep up the good work.

Jack L. Field  
Raleigh, NC

*Magazine publishing is one of those funny businesses where a lot of other people's hands go into producing and delivering your product. For example, we compile, typeset and paste-up each issue of Portable 100 here in Camden, Maine. We then send the "boards" to our printer, who in turn sends the printed magazine to a mailing house that in turn delivers the labeled magazines to the U.S. Post Office for mailing to our subscribers.*

*In an attempt to get every issue to our subscribers in a timely fashion, we send boards to the printer at least eight weeks before the cover date. After that, we have little direct control over production and delivery. We're not pointing any fingers, but....*

*In any case, a sincere effort is being made to improve what has been an unacceptable situation. Recently we were approved for a second-class postage permit. This should significantly speed up delivery time and assure that each issue arrives in good condition. Other steps are currently being implemented so that by the time you read this, our subscribers will consider it old news.*

— Ed.

## TRAVEL TIP

The article about traveling with the Model 100 (April 1986) rang very true for this writer. I am in my third year of carrying the 100 everywhere I go, on four continents. The single most useful

accessory: the dental rubber bands under the keys to eliminate that horrible click.

One addition to the article: some camera stores sell a solar recharger for AA batteries. Just carry an extra set of rechargeables, and leave one set charging in the hotel or rental car window and leave all those adapters and cables behind.

A local firm manufactures them: Solar Electric Engineering, 405 East D Street, Petaluma, CA 94952, (707) 765-1986. Cost is \$16.95 plus shipping.

By the way, I'm writing this from poolside on a warm afternoon instead of sitting in front of my overheating mainframe downtown at the office; the Model 100 has uses besides international journalism.

Chod Harris  
Santa Rosa, CA

## THE 200 DIFFERENCE

I wrote an assembly language program for the Model 100 that prepares certain information and sends it to an industrial controller through the RS-232 port. My program does the sending by making a call to the ROM routine SD232C, located at 6E32 hex. I've attempted to modify the program to run on the Tandy 200, and it doesn't work right — the 200 ROM routine for sending a character to the RS-232 (located at 8624) doesn't send. What have I done wrong?

Dick Hames  
West Bloomfield, MI

Contributing editor Carl Oppedahl, author of *Inside the Model 100*, published by Weber Systems, explains: *Microsoft followed certain conventions in defining the entry and exit conditions of its subroutine calls for the Model 100. In almost every case, for example, the A and HI registers are used to pass information to the routine. When Microsoft developed the Tandy 200 ROM, nearly every Model 100 subroutine was replicated in the 200, with identical entry and exit conditions. The changes were those required to handle the internal hardware differ-*



# Memory Upgrades for Tandy Portables!

## Model 600



### 96K RAM Upgrade \$249. or \$465. for two

Save up to \$335 with this upgrade designed specifically for the Model 600. The 96K upgrade card fits into existing slots in the Model 600 and adds either 96K or 192K of RAM to the computer.

## Model 200

### 24K RAM Upgrade \$89.00 Two for \$170.

Save up to \$330 with this exact replacement while bringing your Model 200 up to 72K.

## Model 100, 8201 or M10

### 8K RAM Upgrade \$27.00 \$75. for pkg. of 3

Save up to \$282. upgrading an 8K Model 100 to 32K. The modules also fit the NEC8201 and the Olivetti M10.

## ★ ★ ★ BUY QUALITY & SAVE ★ ★ ★

All three upgrades feature low power version of CMOS static RAM for minimum battery drain and maximum reliability. Our products are 100% tested before they leave the factory. Every upgrade carries with it a 30 day satisfaction money back guarantee and 1 yr. replacement warranty. Step by step illustrated instructions are included, and our customer service support is as close as your phone.

TO ORDER  
CALL 714-540-1174  
or WRITE

M/C, VISA, CHECK or MONEY ORDER  
CALIF. RESIDENTS ADD 6% Sales Tax

SHIPPING-ADD  
UPS Ground \$1.50  
2nd Day Air \$4.00  
Next Day Air \$12.00

Tandy is a registered trademark of Tandy Corp.

 **American  
Cryptronics, Inc.**

(Formerly Cryptronics, Inc.)  
1580 Corporate Drive, Suite 123  
Costa Mesa, California 92626  
(714) 540-1174

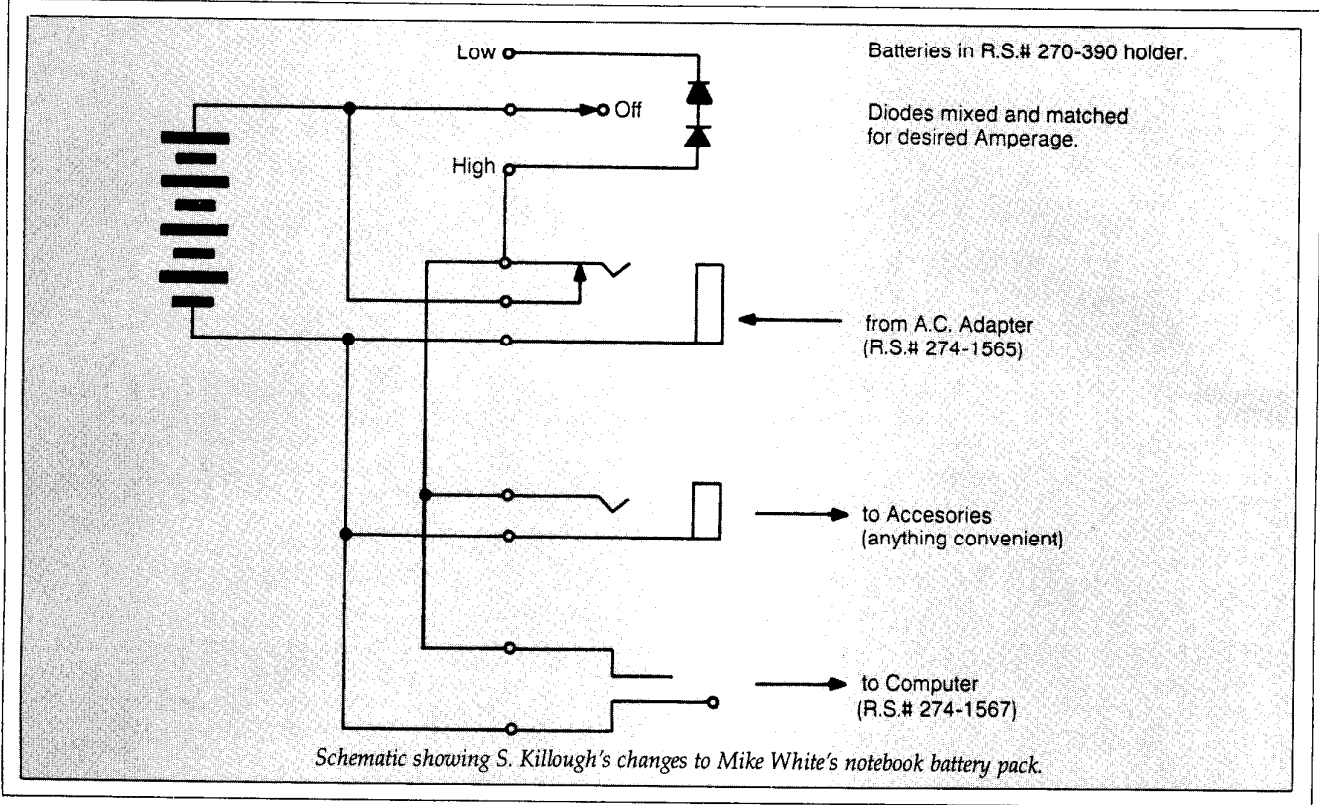

Schematic showing S. Killough's changes to Mike White's notebook battery pack.

ences.

Your question prompted me to disassemble and study the SD232C routine. As one would expect, in the Model 100 you put the character to send in the A register before calling the routine (at 6E32). The big surprise is that in the Tandy 200, you must place the character to send in the C register.

Therefore, you should change your program to read something like this:

```
SD232C    MOV    C,A
          JP     8624h
.
.
.
          CALL  SD232C
```

That should be all you need.

—Ed.

**GET YOUR PLUGS HERE**

I want to make my own modem cable but Radio Shack can't sell me the plug that fits in the phone connector of my Model 100. Where can I get one?

Erika Karplus  
New York, NY

The plug is available for \$3.25 from Beck-

with Computers and Electronics, 23 Stonegate Center, Valley Park, MO 63088, (314) 225-4846.

**SHOW ME USER GROUP**

Anyone interested in starting a user group in the Springfield, MO area is encouraged to contact Mike McKee at (417) 831-2210.

—Ed.

**EVEN BETTER**

Thanks to Mike White for his notebook battery-pack article in the April (1986) issue. I enjoyed the project, but figured I might as well combine some other good ideas with it. Instead of using D cells, I used rechargeable C cells. These have the same output so I thought I'd save a little space.

I also added a small utility box with the good old diode (actually two diodes to drop the current) so I could recharge the batteries while plugged in at home. A SPDI Center Off switch was used to control the charging. In the Center-Off position, charging is bypassed. By shorting out the diodes, the batteries can be charged at the "high" rate of 330 milliamps (mA) in four

hours. With the diodes, it's close to 100 mA for the traditional overnight charge. I also threw in a jack to cover powering my cassette drive while on the road.

S. Killough  
Philadelphia, PA

**HANGMAN CORRECTION**

Having trouble reading line 1350 in the HANGMAN.BA listing (May 1986)? So did we. It should read: 1350 PRINT CHR\$(31).

—Ed.

**COW POKE**

I read Grant Mangold's article "Down on the Farm" with interest. It occurred to me that Rick Allen's sorting program provides more flexibility than my "pseudo-BASIC-remark" (PBR) method. But PBR doesn't require programming and may operate faster. I'm referring to treating records as BASIC statements, or actually as BASIC remarks. For example:

10 'Record number one is everything after the apostrophe, up to 255 charac-



ters (including the label, space and apostrophe).  
20 Record number 20 is everything after the apostrophe, up to 255 characters ... and so on.

The software is already in ROM to EDIT, LIST and LLIST individual records and ranges of records. If the records pertain to livestock, you could probably get them to RUN too.

Mark Laster  
Annapolis, MD

### FOR YOUR NEC

Along with an appeal for some continued attention, beyond the advertisements, to the interests of users of the NEC 8201, I'm enclosing a revision of Frank Schrader's TYPE.BA program (April 1986, page 57) that will run on the NEC in conjunction with at least the Okidata 92 and Epson FX-85.

The changes are:

```
60 PRINT "When ready hit GRPH C to
print."
100 IF ASC(A$) = 130 THEN LPRINT B$:
GOTO 70
```

I suspect the changes are simply NEC-specific and will work on anything the NEC can print on — but those are two printers I have used.

Clyde Hankey  
Youngstown, OH

*Portable 100, as our cover's tag line says, is the magazine of Tandy briefcase computing. Because of the similarities between the Model 100 and NEC 8201, our coverage of the Tandy portable includes by extension its Kyocera cousin. However, since we have our hands full checking and debugging programs for the Tandy portables, we have neither the time nor the expertise to modify them for the NEC.*

*But apparently some of our NEC readers do. So to help keep fellow NEC owners "in the know," send us NEC-related modifications to programs you've seen in Portable 100. We'll publish what's appropriate.*

—Ed.

### PRINTER CODING PROBLEMS

Has anyone solved the printer coding problems between Portable Computer Support Group's Write ROM on the Model 100 and the Epson JX80 color printer with NLQ LetterType?

I can get the Model 100 to tell the

JX80 to change colors on the same line in BASIC without any trouble. Write ROM can get the color changes in native font to work without difficulty. However, when the NLQ board is activated, the JX80 becomes confused and misses part of the color change code from the Model 100, as shown by analysis of printer hex dumps.

If someone out there has found a trick or solution, it would certainly be helpful. I am aware this is an unusual combination, but a very useful one, if it could be made to work!

Robert Briggs  
Kensington, CA

### SPEECH THERAPY

*It has come to our attention that there were a few small errors in the article "My 100 TT/AO/PA/KK/SS (TALKS)," published in the March 1986 issue. In reference to the schematic in Figure 1 on page 41:*

1. On the 7400 NAND Gate, pin 14 should go to +5.0 volts, pin 7 should go to ground.

2. Results with lower voltages might be improved if an SN74LSOON is substituted for the 7400 specified.

3. On the SPO2561C, tie pins 10 and 11 to ground; add a jumper from pin 2 to 25.

4. The audio amplifier was an LM 386, or similar device.

—Ed.

### A LAWYER WHEN YOU NEED ONE

The problem encountered by Ralph Hall (GIGO, March 1986) has a simple solution.

Tandy's Scripsit 100, CALNDR, BCALC and I'm sure many other machine language programs do indeed render FLOPPY.CO unavailable. Not only that but in some cases the function keys are disabled.

I wrote a short program to overcome this problem. I call it FIX.BA.

```
10 CLEAR 256,59400
20 KEY 8, "MENU"+CHR$(13)
30 KEY 4, "RUN"+CHR$(13)
40 KEY 1, "FILES"+CHR$(13)
50 KEY 5, "LIST"+CHR$(13)
60 MENU
```

I can assure Mr. Hall that it won't harm any of the programs mentioned above.

Incidentally, I'm a lawyer working in an office that's slowly coming to grips with the 20th-century. I've been

pounding on my Model 100 all day, every day for the past few years. It's never skipped a beat.

Paul H. Werner  
Loomis, CA

### DISK DRIVE TIP

When using the Tandy portable disk drive and the FLOPPY.CO program that comes with the drive, I've noticed that you lose about 8K of RAM. That's a lot for the Model 100, and even more of a loss in one bank of the Tandy 200.

While looking at the Tandy utility disk, I found a very useful program called SETRAM.BA. I've made up a smaller version that does the same things:

```
1 PRINT "(F)ree or S)et"
2 Q$=INKEY$:IF Q$="" THEN 2
3 IF Q$="s" OR Q$="S" THEN
CLEAR 256,59400:MENU
4 IF Q$="f" OR Q$="F" THEN
CLEAR 256,MAXRAM:MENU
```

For the Tandy 200, change 59400 to 57500. Also, you can replace MENU with RUNM "FLOPPY.CO" to run the disk-drive program immediately.

When you need to run the FLOPPY program, run SETRAM and give the S option. After your drive operation, when you want to recover some RAM, run SETRAM with the F option. You'll recover about 4K!

To reclaim that other 4K, you could KILL "FLOPPY.CO" and run the program instead with CALL 59400 (57500 on the Tandy 200). But this is dangerous — if anything happens to upper memory, FLOPPY is gone!

Jay R. Holcomb  
Waseca, MN

### BUT IT WORKS

Paul Silagi's article on cabling the Model 100 to a PC (Portable 100, February 1986) got me off my duff. I have been lazily sending my files up to CompuServe and then downloading them at my office, telling myself that someday I'd get the communications tools to go direct.

But then I changed offices and there's no data line near my desk. Silagi's article suggested just the thing. I do wonder why on step three he uses MODE COM1:30,E,7,1 as he could stop right after the 30 (the rest are defaults). And I wonder why he chooses 300

*Text continues on page 42*

# Simple Serial Connections

**B**attling with RS-232 serial interfaces? That tangle of cables got you down? Well, help is available from a new serial cabling system that simplifies equipment connections.

It's called Eazy Connect and it converts all types of RS-232 connectors into a simple modular system.

Eazy Connect is a family of adapters. Each is designed to attach to the most popular computers, printers, modems etc. One end plugs into the device and the other end connects to the Eazy Connect Switch via an RJ-12 conductor cable. The switch can route data between up to four computers, modems or peripherals. The switch uses the same RJ-12 modular cable and can be switched between one input and four



outputs or four inputs and one output. It can also be cascaded, offering a low cost network capability.

Eazy Connect adapters are priced at \$12.95 each. The switch is available for \$59.95. The RJ-12 cables come in seven

and 25 foot lengths and are \$3.25 and \$6.50 respectively. User-specified lengths are available. Contact Black Box Corporation, P.O. Box 12800, Pittsburgh, PA 15241. (412) 746-5500.

Circle No. 82



## In any Environment

Neither snow, nor sleet nor gloom of night will keep this Model 100 from its appointed data acquisition.

Elexor Associates has introduced the DataLog-100, a complete data acquisition system in a weather-resistant case. Once a custom-made unit, the product is now being offered "off-the-shelf."

Standard configuration includes a Model 100, data acquisition board, data tape recorder, 80-column printer, internal rechargeable battery and charger. All this comes in a rugged case well suited for any environment from oil rigs to automotive shops.

A standard system has 16 channels 12 bit A/D, 32 digital I/O bits and four digital analog channels (expandable to over 400 analog channels). A complete acquisition software package is included. Custom configurations are available.

The DataLog-100 sells for \$3,895. Contact Elexor Associates, Inc, P.O. Box 246, Morris Plains, NJ 07950, (201) 299-1615.

Circle No. 81

Text continues on page 43

# Give your Model 100 128K RAM

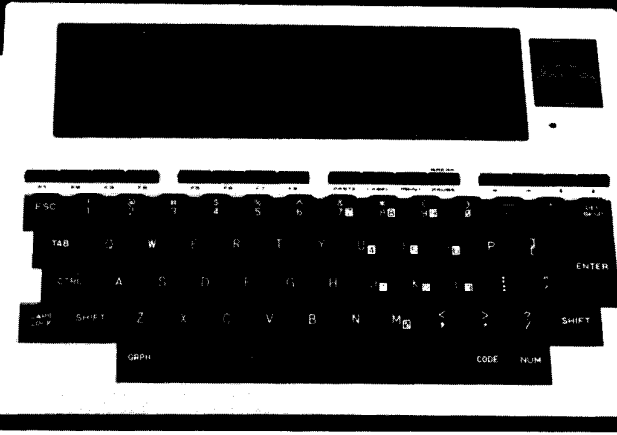

Software included,  
transfers from  
bank to bank.

Works like main  
menu! Includes  
powerful RAM Basic  
that lets programs  
store and access data  
from any other bank.

~~\$425~~  
Sale ends  
July 31, 1986  
**\$349.00**

As amazing as it seems you can upgrade your Model 100 to 128K of RAM in just 60 seconds.

It comes right out of the box looking just like the picture. You just open the little compartment on the back of your Model 100 with a quarter and it just pushes right into place. You can then put the cover back in its place.

You then have 4 banks of RAM of 32K each. The additional three banks also work just like your Main Menu.

You push a function key and you are in the second bank. Push again and you are in third, again, then fourth. Press it once again for your original bank.

It has its own built-in NiCad battery that recharges right from the Model 100 and its guaranteed for a full year.

What is really great is that you can copy a file from one bank to another with just a function key.

Each bank is like having another Model 100, and all the built-in programs as well as any snap-in ROM programs appear in all four banks and work the same way. Your widebar cursor moves from file to file and you access any file or run any program just by pressing ENTER.

What lets you copy any file from one bank to another is a snap-in ROM from PCSG called RAM+, that comes at no extra charge. It pushes right into the little socket in that same compartment with the 96K expansion unit.

Not only does this firmware let you copy a file from bank to bank, but you can make a copy of any file within the same bank instantly with a function key. Great for Lucid spreadsheets!

## Copy a file from bank to bank with a function key

You can also rename a file, or kill any file with just a function key. Plus you can do a whole lot of other useful things like setting the date, day and time with function key ease. You even have a function key that lets you use non-Radio Shack printers without having to make those tricky dipswitch settings.



Installs as easily  
as plugging in a socket



RAM+ lets you cold start any one of your banks without affecting the other three. That means that anytime you want you can clean out a bank's entire memory, but leave intact all the files in the other banks.

What is also fantastic is that you don't have to have the ROM in place to use the additional RAM. Whenever you take out the snap-in ROM it leaves behind a tiny machine code program that lets you switch from bank to bank just by pressing ENTER.

This lets you use your ROM socket to snap-in other ROMs like the amazing SUPER ROM, or DISK + ROM file transfer program, and use them in any or all four banks. All of these, by the way, are available from PCSG.

When you are ready to copy a file from one bank to another or use any of the other fantastic functions we talked about you can just snap the RAM+ ROM back into place.

Everybody that has this 128K system in their Model 100 is so excited, because it gives them four times the capacity and all banks work just like the Main Menu.

And what has made a lot of people happy is that the system bus, located in the same compartment, is left free for you to plug in a DVI or the Holmes Engineering/PCSG portable disk drive.

The ability to copy a file from bank to bank instantly with a function key, plus all of the other features make this RAM extension truly an engineering masterpiece.

This is the only memory expansion that gives you 3 extra banks of RAM. That's 50% more than any other RAM expansion product. Thousands have been shipped to satisfied customers over the past 12 months—more are installed and working reliably than any competitive product.

Some people hesitate when they think of installing something, and then others are skeptical that any additional hardware could be as good as the Model 100 itself. That's why we sell these 96K expansions on a 30 day trial. Simply return it within 30 days for a full refund if you are not satisfied. Priced at ~~\$425~~. MC VISA COD.



PORTABLE COMPUTER SUPPORT GROUP

11035 Harry Hines Blvd. #207  
Dallas, Texas 75229  
214-351-0564

Circle 33 on Reader Service Card

PCSG offers a 30-day/money-back trial! • Also available for the model 200.



# A Key to File Management

*Here's a utility to help you organize your random access memory and tape files.*

By Linwood McDowell

**W**orking with serial tape storage is a source of considerable frustration, especially when one has been spoiled by the convenience of random access (disk) storage. At the time I came to this revelation, I'd only had my Model 100 a short while and had no knowledge of such niceties as tape backup utilities. So, having nowhere else to turn, I decided to take matters into my own hands — literally.

Prior experience with BASIC made learning the Model 100 version a snap, and it wasn't long before I was diligently hacking away. Though I had some great ideas, I soon realized that my greatest obstacle was an ignorance of the machine's inner structure. Unless I could tap this reservoir of power, I knew I was dead in the water. Moreover, I had no experience from which to draw as I attempted to design and implement such a utility.

Then I read Jesse Bob Overholt's articles (*Portable 100*, July - September 1984) on constructing a file management utility featuring a system for managing cassette tape files. Though I never keyed in the listing, by the time I'd completed the series I was convinced that I could write a full-featured file management utility of my own (if I could just gain access to all that power).

A trip to a local bookstore produced Christopher Morgan's *Hidden Powers of the TRS-80*, a volume that eventually became my trusted ally as I probed the dark secrets of the Model 100's ROM. I began the odyssey in December of 1984, writing and scrapping literally hundreds of routines in a period of 18 months. In time, I came to understand the internal logic of the machine and was able to develop a very reliable and extremely user-friendly program KEYS.

By way of introduction, KEYS is a dynamic document file management utility. It makes extensive use of machine language subroutines especially for special display effects. KEYS is not a text formatter nor will it manage your BASIC and machine language programs (although these will be dis-

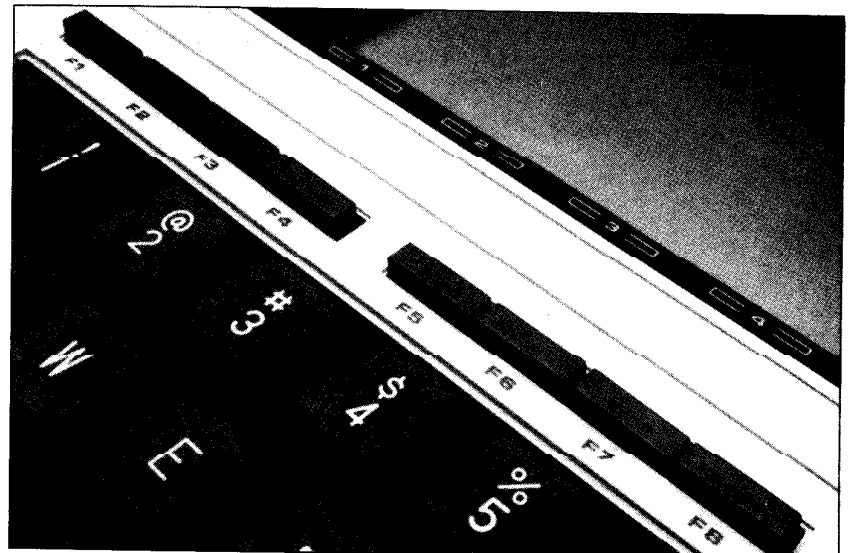

played and can be run from the KEYS menu). It has powerful integrated features that allow you to organize and maintain random access memory (RAM) and tape files. Chief among its features are permissive random selection of files for save, load or kill processing, display of various memory statistics to assist in memory management and creation of separate tape file directories of documents selected for tape backup.

Because KEYS uses about 7.5 kilobytes (K) of RAM, users are advised that at least a 16K system is required to load and run the software. During its initial load and run line 2 is deleted, freeing up some memory and reducing the listing to 7.3K. In contrast, approximately 2.1K are tapped for various string, array and file manipulations.

## SETTING UP

As you type in the listing you may notice an occasional line of code in which a direct statement (such as a prompt) doesn't end in a closed quotation mark ("). This syntax is perfectly acceptable and is useful for conserving a byte or two of precious memory. Closed quotation marks have been included where required to avoid possi-

ble confusion, so type each line exactly as it appears in the listing. After typing in the listing, be sure to save KEYS to tape before attempting to run it.

Prior to loading and running KEYS, habitual users of machine language programs (ML) will have to replace the keyword MAXRAM in line 8 with the highest memory address (HIMEM) available to BASIC. This will reserve memory for your ML applications.

If you use a ML program, don't attempt to run KEYS until after this requirement has been met. Moreover, I recommend that you remove all files from your machine until after HIMEM has been set and KEYS has been initially run and saved.

During initialization, a ML routine is CALLED to clear the soft keys of their default values. Because the four command keys (paste, label, etc.) are not affected, you may inadvertently press one of these and have to SHIFT-BREAK the program to regain control. Should it become necessary to break the program, just remember to restart it (via RUN or CONT) prior to exiting to the Model 100 menu. Properly exiting the program (using key F8) is the best way to ensure that your soft keys are always reset to their default values.

Now let's look at the display. Note

## FILE MANAGEMENT

that the KEYS menu consists of three sections. The top line is the status line and maintains various statistical data. The first column, "mem," monitors the free memory space currently available. This data is updated as menu options are selected and executed or canceled. The second column, "bys," displays the size in bytes of the file over which the cursor is currently positioned. The third column, "usd," is the total number of bytes used by all files in the directory excluding KEYS.

The final column, "bgn," requires some explanation. For all intents and purposes, this has been designated the "beginning memory." The beginning memory is a constant value that is determined during initialization or after new RAM files are opened, current RAM files are deleted or tape files are loaded. To alert you that a low memory condition exists, the beginning memory will be displayed in reverse video should its value drop below 1,171 bytes. At this point, you should consider either deleting or saving any unnecessary files.

Just below the status line is a directory (running top to bottom and left to right) of all resident RAM files. It's sorted alphabetically courtesy of a modified Shell-Metzner sorting algorithm. Note that file types are identified by the extensions B (for BASIC), C (for command file written in machine language) or D (for document). KEYS is the only exception to this alphabetical list — it's always the first entry in the directory.

Assignments for future entries are reserved by a pattern of colons. Since you cannot create more than 18 total file entries, position 20 is left vacant. This space is alternately used to display the current time or to showcase other KEYS features. The solid lines create columns of documents and enhance the overall visual effect of the display.

The bottom line is the label line and defines the assigned function of each of the eight soft keys. This line is alternately used to display prompts and error messages or to create fields for data input.

Generally speaking, once a function has been selected, it requires user confirmation prior to its execution. Pressing F5C will cancel a selection while ENTER will confirm and execute it. If you make a mistake while typing data, use DEL BKSP to delete it. Note that data is automatically accepted and processed once the final character of a given field length is entered — other-

wise you must press ENTER to accept the data.

Movement between files is accomplished by use of the up or down cursor control keys. Observe that as the cursor moves from file to file, the value of the bys column changes to reflect the size of the file.

To open a document for editing or to run other software, simply position the cursor over the selected file and press ENTER twice. Built-in error handling

routines render system crashes virtually nonexistent; however, should a previously undetected error occur, the screen will clear and the error number and offending line number will be displayed.

Following is a description of each key assignment:

F1 - OPEN: Press OPEN to set up a field for creating as many as 18 new document files. Attempts to create more than 18 documents will cause an

```
mem:17377!bys: 2817!usd: 2820!bgn:17672
KEYS   E! : : : : : : : : : : : : : : : : : : : :
COPY   D! : : : : : : : : : : : : : : : : : : :
FORMS  D! : : : : : : : : : : : : : : : : : : :
NAMES  D! : : : : : : : : : : : : : : : : : : :
PAPERS D! : : : : : : : : : : : : : : : : : : :
time:0010
```

```
OPEN READ FIND NAME TIME BKUP KILL QUIT
```

An example of the KEYS display.

KEYS.BA: A file management utility for the Model 100.

```
2 CLS
:PR$=""
:RV=17001
:GOSUB 944
:AS="2"+CHR$(13)+"RUN"+CHR$(13)
:FOR A=1 TO LEN(AS)
:POKE 65449+2*A,ASC(MID$(AS,A,1))
:POKE 65450+2*A,0
:NEXT
:POKE 65450,A-1
:SAVE "KEYS"
4 MOTOR OFF
:SOUND OFF
:CLS
:SCREEN0,0
:CALL 17471
:CALL 17006
:PRINT @97,CHR$(34)+"KEYS"+CHR$(34)
8 MAXFILES=2
:CLEAR900,MAXRAM
:ON ERROR GOTO 2000
:DIMF$(20),AD(20),RC(20),SZ(20)
:LL=280
:NV=17006
:PB=PEEK(63909)+PEEK(63910)*256
:RV=17001
:LB$="OPEN READ FIND NAME TIME BKUP KILL QUIT "
:US$="####"
10 M2=FRE(0)
:FOR A=63930 TO 64138 STEP 11
:IF PEEK(A)>0 THEN B=B+1
:F$(B)-SPACE$(8)+CHR$(PEEK(A+2))
:FOR C=1 TO 6
:MID$(F$(B),C)=CHR$(PEEK(A+C+2))
:NEXT
:AD(B)=PEEK(A+1)+PEEK(A+2)*256
:IF F$(B)="KEYS B" THEN MID$(F$(B),9)=" "
```

## FILE MANAGEMENT

error message to be displayed. Press ESC to exit the mode (the directory will be sorted if new files have been created).

F2 - READ: Press READ to display the selected document file. Note that the document filename appears at the bottom of the screen. When data output reaches the end of the sixth consecutive line, a percentage of output is calculated; this is displayed to serve as a user reference point. To view subsequent screens of data, continue to press ENTER. Press ESC to return to the main menu display. You'll be prompted at the end of the file. Press ESC or ENTER to return to the main menu display.

Attempts to display a program file or an empty document file are not permitted and will result in an appropriate error message.

F3 - FIND: Press FIND to search a file for a string of up to 27 characters long. This routine is case sensitive, so the search string must match the target string exactly. If found, the target string is displayed in reverse video, and you'll be prompted. Pressing ENTER continues the search for the next occurrence of the string. While active, pressing F8 will return you to the main menu display; otherwise, use ESC to exit the mode. Attempts to search a program file or an empty document file are not permitted and will result in an appropriate error message.

F4 - NAME: Press NAME to rename a file. Attempts to rename KEYS are ignored. Press ESC to exit the mode (the directory will be sorted if a file has been renamed).

F5 - TIME: Press TIME to display the current time. Note that it is displayed in the 24 hour format.

F6 - BKUP: Press BKUP to save or load selected document files. Ensure that your recorder is set for either the RECORD (CSAVE) or PLAY (CLOAD) modes. When SAVE is selected, you'll be prompted for a six character string to identify the tape cassette. The first character is the side of the cassette (A or B). The next two characters are the cassette number and can be any two numbers from 00 to 99. The final three characters are the recorder counter setting (to identify the starting position on the tape where the directory will be written) and can be any three numbers from 000 to 999. For example, the number A01234 would indicate that selected document files will be saved to side "A" of cassette one, beginning at counter setting 234. Once a valid ID

*Text continues on page 44*

```
12 NEXT
   :NF=B
   :SO=1
   :GOSUB 900
   :AD(NF+1)=PEEK(64434)+PEEK(64435)*256
   :FOR A=1 TO NF
   :B=AD(A+1)
   :IF AD(A)<PR AND R>PR THEN B=PB
14 SZ(A)=B-AD(A)
   :NEXT
   :B=NF
   :SO=2
   :GOSUB 900
   :MID$(F$(1),9)="B"
   :FOR X=NF TO 19
   :F$(X+1)=STRING$(9,58)
   :NEXT
   :F$(X)=SPACE$(9)
   :FOR X=2 TO NF
   :TB=TB+SZ(X)
   :IF MID$(F$(X),9)="D" AND DO=0 THEN DO=X
20 NEXT
   :A=40
   :FOR B=1 TO 5
   :FOR C=0 TO 15 STEP 5
   :DR0-DR0+F0(D+C)+CHR0(245)
   :RC(B+C)=A
   :A=A+10
   :NEXT
   :MID$(DR$,40*B)=" "
   :NEXT
   :FOR B=1 TO 4
   :DR$=DR$+STRING$(9,241)+CHR$(248)
   :NEXT
   :MID$(DR$,240)=CHR$(241)
   :X=1
30 CLOSE
   :CALL 17471
   :CALL 16954
   :SR$=""
   :SV$=""
   :TG$=""
   :SL$="mem:"+RIGHT$(SPACE$(3)+STR$(FRE(0)-2),5)
   :CHR$(245)+"bys
   :"+RIGHT$(SPACE$(3)+STR$(SZ(X)),5)+CHR$(245)+
   : "ud:"+RIGHT$(SPACE$(3)+STR$(TB),5)+CHR$(245)
   : "+bgn:"+RIGHT$(SPACE$(3)+STR$(M2),5)+" "
40 CALL NV
   :PRINT @0,SL$,DR$
   :CALL RV
   :GOSUB 914
   :GOTO 938
42 KEYON
   :KYS=INKEY$
   :CALL NV
   :PRINT @4,USING0$;FRE(0)+6
   :IF KYS="" OR NF=1 THEN 42 ELSE KY=ASC(KYS)
   :KEYOFF
   :IF KY<30 OR KY>31 THEN IF KY=13 THEN 50 ELSE 42
44 PRINT @RC(X),F$(X)
   :IF KY=30 THEN X=X-1 ELSE X=X+1
   :IF X>NF THEN X=1
46 IF X<1 THEN X=NF
48 CALL RV
   :PRINT @RC(X),F$(X)
   :CALL NV
   :PRINT @14,USING0$;SZ(X)
   :GOTO 42
50 IF X=1 THEN 42 ELSE F$=F$(X)
```

*Listing continues on page 44*



# The Bridge Over The River DOS

By Alan L. Zeichick



The newest product from Traveling Software does exactly what its ad claim: LapDOS breaks the barriers between Tandy laptop portables and desktop MS-DOS-based PCs.

LapDOS is merely the latest in a series of third-party products that combine the flexibility of the Model 100 and Tandy 200 with the sheer power of an IBM PC or compatible. Portable Computer Support Group's (PCSG) Disk Plus gives a Tandy laptop control over a PC's disk drives — even by modem. Sigea System's Telecommuter offers high-speed file transfer between portables and PCs, as well as a desktop bulletin board system. But both systems require that the two machines be connected, using either a direct-connect cable or telephone line. LapDOS takes a new approach: Independence.

The key is the Tandy Portable Disk Drive (PDD). Unlike its competitors, the 3.5-inch disk drive connects to the Model 100 and Tandy 200 via the RS-232 serial port — not the system bus connection. That, theoretically, makes the PDD hardware independent, since

any computer with an RS-232 port and correct software should be able to control the disk drive.

Traveling Software turned the theory into fact. LapDOS, simply stated, is the MS-DOS software that controls the PDD. When the PDD is connected to a PC's serial port, the desktop computer has full control over the drive, with the ability to format disks and copy files to and from MS-DOS 5.25-inch floppies and even multi-megabyte hard drives.

## BREAKING BARRIERS

The LapDOS program for the PC is a single file, LAP.EXE. (.EXE and .COM on a PC are equivalent to the .CO file extension on the Model 100 and Tandy 200.) The non-copy-protected file can be copied onto any PC disk.

Connecting the PDD to the PC's RS-232 port is easy. Since many PC serial ports have a male connector (like the one on the PDD cable), Traveling Software has included a "LapDOS Cable Converter." Use this adapter to connect the PDD cable to the PC serial port.

Since the manual explicitly states that the adapter is necessary, Traveling Software seems to make the assumption that all PC serial ports use a male connector. If your PC's RS-232 has a female connector, though, don't just connect the PDD cable directly to the port. The cable converter has special circuitry needed for adapting the different voltage levels used by the PC serial port and the PDD. Pick up a female-to-female straight-through gender changer at your local computer shop — that'll solve the compatibility problem.

Before running LAP.EXE there's one more setup task: changing the DIP switch settings on the PDD. LapDOS expects that the PDD will be operating at 9,600 bits per second (bps), which is the highest speed that MS-DOS allows. So, set the first PDD switch on and the other three off.

Running LapDOS reveals a two-part screen. On the left, LapDOS displays the names and sizes of the files contained in the PC's default directory. On the right, the contents of the PDD's 3.5-inch disk are shown. At the upper

## REVIEWS

right is a wide-bar cursor, which moves from file to file under cursor-key control.

LapDOS offers a choice of 13 commands, most of which apply to both PC and PDD files: *Help, Log, View, Copy, Wildcopy, Format, Erase, Rename, Xchange, Unload, Timing, Snow* and *Quit*. Commands are selected by pressing the first letter of the command name.

*Help* summarizes uses of the 13 commands on a single screen — handy for those times when the manual isn't present. Actually, the help display is nearly as useful: Most commands receive less than one page of text in the printed manual.

The name of the *log* command is reminiscent of the early days of computing, when changing a disk was referred to as *logging in* a new disk. If the wide-bar cursor is on the MS-DOS side of the screen, *log* causes LapDOS to re-read a disk directory after changing floppy disks, or transfer from one drive to another device. If the cursor is on the PDD side, you're prompted to change disks and press Enter. LapDOS then displays the file names stored on the new disk.

The *view* command is handy for checking the contents of a file before copying or erasing it. While viewing a file, pressing any key pauses the display and Ctrl-Q aborts the viewing.

*Copy* and *Wildcopy* are the most common LapDOS functions, transferring disk files from one drive to another. MS-DOS files may be copied to either the PDD or any PC disk drive; PDD files may only be copied to the PC. By default, files are copied with the same file name and extension; however, *copy* plays with MS-DOS file names. Names longer than six characters are truncated, and file extensions other than .CO and .BA are changed to .DO. That means that the common MS-DOS file *AUTOEXEC.BAT* would be copied to the PDD as *AUTOEX.DO*. Similarly, when copying from the PDD to the PC, LapDOS changes illegal characters (such as ? and \*) to a hyphen. If LapDOS's name isn't to your liking, the program offers a chance to manually enter a new file name, but it only allows the three PDD file extensions .BA, .CO and .DO.

*Wildcopy* is a version of *copy* that transfers multiple files from one device to another. Unlike *copy*, the file description is typed on the keyboard instead of being selected by the wide-bar cursor; the standard MS-DOS wildcard characters ? and \* are used to select related groups of files for transfer. Un-

like *copy*, *wildcopy* doesn't give you a chance to manually specify new file names. Both *copy* commands, though, ask for permission to copy over an existing program.

*Format* is similar to the function in Tandy's FLOPPY.CO program for the Model 100 and Tandy 200. *Format* prepares a 3.5-inch disk for use — erasing everything on the disk in the process. *Format* only works on PDD disks; the manual advises using MS-DOS's

---

**LapDOS**  
IBM PC link for a  
Tandy Disk Drive  
Traveling Software  
11050 Fifth Ave N.E.  
Seattle, WA 98125  
(800) 343-8080  
\$89.95  
Circle No. 141

---

*FORMAT* command for creating blank 5.25-inch disks.

*Erase*, on the other hand, works on both PDD and normal PC files. Erasing a file on the PC takes only a second; removing a PDD files takes much, much longer.

The *Rename* command allows you to change the names and file extensions of both PC and PDD files. LapDOS only allows three PDD file extensions — .BA, .CO and .DO. Although it's possible, the LapDOS manual advises against changing a PDD file extension — and we echo that advice, since loading a file with the wrong extension into a Model 100 or Tandy 200 could have unpredictable consequences.

### ASCII AND YE SHALL RECEIVE

*Xchange* is the most unusual LapDOS feature. The program converts the special-format MS-DOS files to and from the formats used by the Model 100 and Tandy 200.

Let's say you use Traveling Software's outline processor *Idea* on your Model 100, and use Living Videotext's *ThinkTank* on your PC. Want to share data files between your laptop and desktop? LapDOS converts:

- *Idea* to *ThinkTank*
- *Idea* to standard ASCII
- *Thinktank* to *Idea*
- *Thinktank* to standard ASCII
- ASCII to *Idea*

- ASCII to *ThinkTank*

For good measure, LapDOS throws in a couple more:

- *SideKick* to *Idea*
- *WordStar* to ASCII

*SideKick* is Borland International's memory-resident program for the PC that offers a pop-up clock, calendar, ASCII reference table, calculator, notepad and appointment calendar. LapDOS's *Xchange* converts *SideKick* appointment files into *Idea* outlines. The last file-conversion option, *WordStar* to ASCII, is listed in the documentation as *Word Processor* to ASCII. That's too vague: Many word processors for the PC have special file formats. LapDOS's conversion format is aimed specifically at *WordStar* and its clones — it won't work on *XyWrite*, *MultiMate* and *WordStar 2000*, to give only three examples. But if you do have *WordStar*, you can convert those files for use with your laptop's *TEXT* or *Traveling Software's T-Writer* and *T-Word*.

Actually, the above file-conversion formats are only one group; a section in the manual describes how to use *Traveling Software's T-base* database manager with several popular PC databases, such as *Ashton-Tate's dBase II* and *dBase III*, *Lotus Development's 1-2-3* and *MicroPro's WordStar Mailmerge*. Most of the conversion is done with *T-base*; LapDOS's role is limited to transferring the data files. LapDOS's manual explains the necessary steps for importing and exporting data files from the Model 100 and Tandy 200; the information would apply if the data were transferred by modem or through *TELECOM*, not only via LapDOS. The manual gives specific information for *dBase II* and *III*, *1-2-3*, *MailMerge* and *Microrim's R-base 5000*.

The LapDOS *unload* command removes LapDOS from memory — but it's only used if the program is executed with the memory-resident option that we'll get to shortly.

*Snow* is a thoughtful feature. On many IBM compatible computers, addressing a color graphics adapter with fast BIOS (basic input-output system) calls results in visible static across the screen, called *snow*. To accommodate users with snow-prone graphics adapters, LapDOS's *snow* function tells the software to use slower but cleaner techniques for writing to the screen. *Snow* can be selected once LapDOS is running or in the command line: *LAP/S*, which initializes LapDOS to use the cleaner techniques.

*Timing* is perhaps the most mysterious of the LapDOS functions. The



# Concerning the portable disk drive: TANDY-CLEARLY INFERIOR.

The  
Chipmunk  
from P.C.S.G. /  
Holmes Engineering



Now only  
**\$399.00**

We support Tandy products, and normally we think they're great, but compared to the Chipmunk, the Tandy disk drive is a mere toy. A simple comparison of their specifications proves it. But because the Tandy drive is much cheaper you may be tempted to think its a reasonable choice despite its inferiority.

The truth is that at \$399, the Chipmunk is plain better value than the Tandy portable disk drive at \$199. Here are the facts:

- 1. Capacity.** Each Chipmunk disk holds 360KB. The Tandy drive capacity is only 101KB. This means that for every Chipmunk diskette you buy, you would have to buy 3½ diskettes for the Tandy. These diskettes cost over \$50.00 for a box of 10. It doesn't take a computer to figure out that the Chipmunk can save you a bunch on diskettes.
- 2. Speed.** Operation of the Chipmunk is virtually instantaneous. Over 6 times faster than the Tandy drive. This is because the Chipmunk technology is inherently superior. It taps directly into the system bus of your Model 100, while the Tandy drive is limited by the slow bottleneck of the serial interface. If you have used a cassette recorder to store your files, you already know the frustration of waiting for a save or load.
- 3. Power.** The Chipmunk automatically provides sophisticated extensions to the Model 100 BASIC that provide true random access on the disk. Random access is the major theoretical advantage of disk storage over tape storage. The Tandy drive lacks random access from BASIC. In fact BASIC can't read or write on the Tandy drive at all! In this respect the Tandy drive is inferior to even a humble cassette player, while the Chipmunk is equivalent to an IBM PC disk drive.
- 4. Rechargeable batteries.** Battery life on the Tandy drive is specified at just 2 hours of continuous use. Then you need to buy a new set. The Chipmunk has built in NiCad batteries which automatically recharge

whenever you have the AC adapter connected. Incidentally the batteries are included on the Chipmunk.

**5. Ease of use.** You may find this difficult to believe, but in order to get the Tandy drive going, you have to type a little 3 line BASIC program into your Model 100 and reset some switches on the drive, run the program and then set the switches back. This is wincing known as 'user hostile.' But you'll love the way you start up the Chipmunk. Just plug it in and press a single button.

In use, the Chipmunk offers you a menu just like the familiar Model 100 main menu but with lots of added power features. To save or load any file you simply move the cursor to the filename and press a function key. Contrast this with the Tandy drive, which steps back a software generation by demanding that you type in the entire file name every time!

Whats more, the Chipmunk comes bundled with lots of powerful free application software. The Tandy drive doesn't include any applications at all.

Life is already full of minor inconveniences and frustrations. Who needs to punish themselves with the Tandy drive? The Chipmunk from PCSG represents superior value, superior technology and superior ease of use. And it's even easier to buy! Just pick up the phone and call us. We accept all the major credit cards, or you can order COD.



**PORTABLE COMPUTER SUPPORT GROUP**

11035 Harry Hines Blvd. #207 • Dallas, Texas 75229

214-351-0564

Circle 37 on Reader Service Card

**PCSG offers a 30-day/money-back trial! • Also available for the model 200.**

Tandy portable disk drive is a registered trademark of Tandy Corp.

## REVIEWS

manual advises that you'll probably never use this command; it's only needed if the message *No Response From Drive* flashes at the side of the display.

When LapDOS is executed, the message *Determining System Timing...* is shown for about four seconds before the split screen appears. Apparently, LapDOS is checking the speed of the MS-DOS based computer against an internal standard. This information is used to gauge how long the PDD should need to perform certain tasks. Under some circumstances — and the manual doesn't explain what they are — this internal test isn't accurate. Therefore, the user must manually change the timing value, revising the time upward until the *No Response From Drive* message stops appearing.

At that point, according to the manual, "Make a note of the value that works with your computer. Then each time you begin using LapDOS, enter that value with the Timing command."

Now, assuming that that is necessary, why doesn't LapDOS allow the selection of the timing value from MS-DOS, as it does with the snow flag? I'd much rather write a one-line MS-DOS batch file that contains the line:

LAP/S/T4000

than attempt to remember to change the value manually.

LapDOS is really two programs in one. As described above, LapDOS is a *foreground* program: one that is called from MS-DOS and *quits* back to MS-DOS.

Traveling Software, riding on the popular memory-resident bandwagon, lets you run LapDOS as a memory-resident pop-up program. Now you can be in the middle of a 1-2-3 spreadsheet, and with a touch of two buttons be able to transfer files from your PDD to your PC. What convenience!

Frankly, I don't see the need for a memory-resident disk transfer program. But that's a matter of taste, since I don't like memory-resident operating-system shells either. When it works, LapDOS can be called at any time (well, almost any time) by pressing Alt-I.

The memory-resident, or background version of LapDOS is loaded with an MS-DOS switch: *LAP/B* or *LAP/RS*. But wait: Since MS-DOS contains no standard for multiple memory-resident programs, you might

be in trouble if you use SideKick, ProKey or any other such program on your PC.

The LapDOS manual dedicates a page to this subject, and covers the potential problems pretty well. They advise that once you have one or more memory-resident programs installed, you may not be able to load or run a memory-resident LapDOS. Traveling Software advises that you try changing the order in which the programs are loaded. If that doesn't work, don't load the other memory-resident program, or only use LapDOS in the foreground.

What can go wrong? Well, when memory-resident programs clash, the usual result is called a *system crash* or *freeze*. That means you need to press Ctrl-Alt-Del or your reset button to restart your PC, and you lose all data that isn't stored on a disk.

A couple other problems with memory-residence: LapDOS can't be called from within any bit-mapped graphics application. So, you can't transfer files from your PDD while displaying a 1-2-3 graph. You can't call LapDOS from any program with a non-standard input routine, such as XyWrite. And, imagine the thrill if your ap-

# POWER — 100 — 200

## THE BEST IN BATTERY TECHNOLOGY

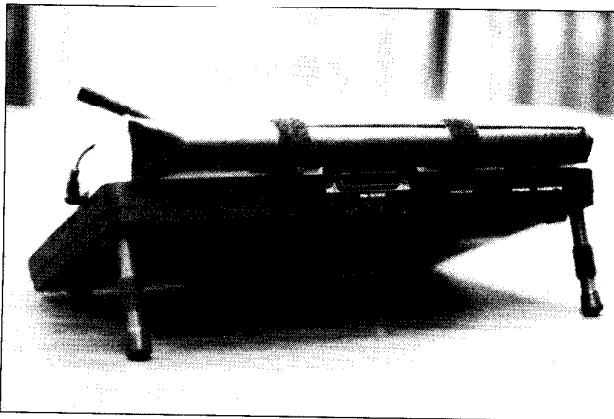

- Powers Model 100, Tandy 200, Tandy 600, Tandy Portable Disk Drive, Chipmunk, NEC's, tape recorders and more!
- Recharge with standard 6 volt adapter — no extra recharger needed!
- Attaches securely to computer — nothing extra to carry.
- Computer still fits in original case with battery attached — as portable as ever.
- Recharge while in use — no downtime!
- 60 day money back guarantee — love it or return it.
- Try it NOW! It SAVES YOU MONEY and you will love the CONVENIENCE!

### FEATURES

RUN TIME: MODEL 100  
TANDY 200

WEIGHT:

LENGTH:

RECHARGE 50%

RECHARGE 100%

PRICE:

### POWER 100

10 HRS

8 HRS

5 oz

10 IN

4 HRS

16 HRS

\$49.95

### POWER 200

13 HRS

11 HRS

7 oz

10 IN

4HRS

16 HRS

\$54.95

CALL 1-804-794-6675 or write to:



**A.R.M.S.**

12131 Old Buckingham Rd.  
Midlothian, VA 23113



Shipping & Handling Included. VA residents add 4%.

## REVIEWS

plication program assigns some important meaning to Alt-L, the same key-stroke that calls up LapDOS.

Remember the *unload* command? It removes the memory-resident version of LapDOS — but only if LapDOS was the last memory-resident program loaded and if it was invoked directly from MS-DOS. If not — well, Ctrl-Alt-Del may be the only way to unlock your keyboard.

I'll be blunt: I couldn't get LapDOS to work peacefully with any other memory-resident program. I don't blame Traveling Software — there just isn't any standard for program cooperation. I believe, however, that LapDOS would be as good a product without the memory-resident option, and would be safer to use.

### ALL THINGS CONSIDERED

Other than my dislike of LapDOS's memory-resident implementation, I'm impressed by the product — and even more impressed with its applications. Here at *Portable 100*, for example, we receive manuscripts and programs on audio cassette and on PDD disk. Since the editors use Tandy MS-DOS com-

puters, a cassette-based manuscript must be loaded into a Model 100 or Tandy 200, then telecommunicated via RS-232 to a PC. That means that we have to fuss with a cassette (that sometimes won't load) and need to make sure that our laptop has sufficient RAM.

If an article submission arrives on PDD disk, we can cut out the middle-man by connecting the PDD directly to a PC and copying the file. No muss, no fuss, and no annoying cassette whine.

I'm happy with Traveling Software's LapDOS. But do you know what would make me happier still? A device driver that would allow the PC full access to the PDD by using existing MS-DOS commands like COPY, ERASE and DIR. Is that too much to ask? □

## Speed is the Gain

About a year ago a reader wrote to us asking if it was technically feasible to save individual text files through BASIC. He'd noticed that BASIC programs were saved faster

than text programs and wanted to take advantage of the increase in speed.

Our answer, culled from various people who claimed to know about such things, was that it was possible but not worthwhile. The reason is that the overhead required would cancel any advantage of high speed.

MinSof Inc. has proved us wrong. Their cassette storage program, called Fast, stores and reads ordinary text files as if they were BASIC programs. By leaving out all those annoying clicks and pauses typical of CSAVE and CLOAD, Fast speeds up cassette storage by as much as a factor of three. And it does so without much sacrifice of memory.

### ON YOUR MARK

Fast is really two BASIC programs: Saver and Loader. It comes on cassette along with a 14-page soft-cover manual that's detailed in its discussion of the programs' operation. If you're at all familiar with cassette storage, you'll have little problem using Fast.

Saver is Fast's version of CSAVE. Prompts guide you through the operation so that you almost don't need the

## CROSS-COUNTRY PILOTS

Retire your E6B. Enter WD, WS, TC, TAS, MV, CD, Distance to Destination, fuel consumption rate and out comes CH, GS, Time to destination, fuel needed and ETA. Upon arrival, Elapsed time and actual avg. GS are displayed. The wind triangle for each situation is plotted on the screen. A hardcopy can be made on the printer.

The above description is for the Model 100. Versions are also available for the Apple II and the IBM-PC on diskette. The Model 100 version is on cassette tape. Send \$29.95 (specify version) plus \$2 for shipping and handling to:

**DELTA SOFTWARE**  
P.O. Box 57  
Mooringsport, LA 71060  
(318)-996-5285

Circle 67 on Reader Service Card

# 512K

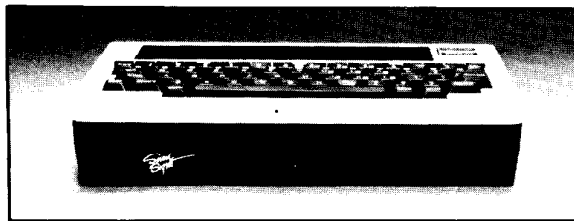

## NOW YOU CAN EXPAND YOUR MODEL 100 UP TO 512K

- **Latest Technology** - uses magnetic bubble memory
- **Non-volatile Memory** - if power fails, data is not lost
- **No Bank Switching** - also built-in error detection
- **One Year Warranty**
- **Fully Portable and Easy to Install**
- **128K** - cost \$999. (includes software)  
Each additional 128K - \$450.

SoundSight Magnetic Bubble Memory Inc.  
225 West Broadway, Suite 509, Glendale, CA 91204  
(213) 463-1519

Circle 12 on Reader Service Card



**SUBSCRIBE**  
**1-800-225-5800**  
**SUBSCRIBE**

## Announcing: CALENDAR

	Sun	Mon	Tue	Wed	Thu	Fri	Sat
Dec 1986		1	2	< 3 >	4	5	6
	7	8	9	10	11	12	13
	14	15	16	17	18	19	20
	21	22	23	24	25	26	27
	28	29	30	31			

10 dentist 6:30AM birthday card AM

### Appointment Calendar for the Model 100.

One screen display is worth a thousand words. Notice how CALENDAR lets you label special days. Now you can spot at a glance the really important events and deadlines coming up each month. And for more detail, the press of a key presents the first line from any "NOTE.DO" entry (see bottom of display).

"Today" is enclosed in brackets, and a gentle tone warns you in case of appointments. Annual events (e.g., birthdays) need only be entered once. Flexible format for listing dates: 12/1 or 12-1 or 12/01/86, etc. This 2.5 K program also corrects the "date-bug" problem inherent in the Model 100. Very easy to use.

### Buy NOW, and get a FREE GIFT!

DECISION-MAKER helps you correlate intuition with logic. When you just can't decide between several courses of possible action, DECISION-MAKER asks you to specify and weigh the factors involved, and then presents a summary of the various options.

### BOTH Programs

**\$24.95**

### Also Available: "FAST"

Save/Load text up to triple-speed. Buy now, and get free, FILE MANAGER: rename and kill files with ease.

**\$19.95**

Send CHECK or MONEY ORDER.

Model 200 version available for either offer, but you must specify.

Want free literature? For quickest response, write directly.

**MinSof, Inc.**  
 Box 1153  
 Minneapolis, MN  
 55440

Circle 10 on Reader Service Card

## REVIEWS

manual.

Saver is programmed to save the last .DO you "visited." For example, say you've typed in a file called TEST.DO and now you want to save it to tape. Exit the file, place the cursor over Saver and hit Enter. The top line of the new display shows the length of TEST.DO. The next line is a "window" feature that shows the first line of text from that file. Even if you started with carriage returns, you'll see the first line of actual text.

Below that are simple instructions. The first step, which is displayed in reverse video is: Press Record. If you want to save the file, you can either type in a name or press Enter. The latter will assign the first six letters of the text as the name of the file. The advan-

**Fast**  
 Cassette storage  
 program  
 MinSof, Inc.  
 Box 1153  
 Minneapolis, MN  
 \$19.95  
 Circle No. 142

tage to this method is that if you use the first six characters in every file as its label, you'd never have to type in a name when saving it. Just hit Enter.

Another option is to back up all text files in memory. To do this, you just type a period and press Enter. Saver automatically assigns "today's" date as the name of the file preceded by a B—for backup. Files are lumped together in one file, separated by black box symbol (GRPH-Shift-X).

Once a file is saved, you have the option to verify it. Verification is pretty simple—just do what the prompts tell you. Press F7 (which calls CLOADM?), rewind your tape to the beginning of the file and play it back. You'll be prompted if the save is "Ok" or if it failed.

### BRING IT BACK

Loader is just as simple to use as Saver. You're given two choices: Press Enter to search the tape for a file you want to load or type in the name for a particular file. By naming a file, Loader will skip everything up to the file selected.

When conducting a search, the program stops at the beginning of each file and gives you its name and size. You're

## REVIEWS

asked if you want to load it. If you press *n* for no, the prompt "Next..." appears on the screen while the program searches for the next file header. This continues until you answer yes or abort the program.

When you find the file you want to load, you'll be asked to enter the name of the random access memory (RAM) file that will receive the text. The default name is TAPE. Once loaded, press F8 to return to the main menu and check your new file.

### TRUTH OF THE MATTER

If you're still committed to cassettes, anything to help speed up the process of loading and saving files is a blessing. And for that reason alone, Fast is worth the money.

MinSof's ads say that Fast can save a 5 kilobyte (K) file in 39 seconds and a 10K file in one minute and six seconds. Using my trusty Timex, I found no significant deviation from that claim. Both saving and loading files with Fast is far-and-away faster than the 100's built-in procedure.

The manual is short and sweet and to the point. Since the programs' (Saver and Loader) display-prompts tell all, there's not much additional explanation necessary to operate them.

One nice feature in the manual is a section on recovering lost data. It explains how to save "old memory" to tape after a cold start and then how to reload it and sort it all out — using Fast, of course. Another short section describes an easy way to organize your cassette files.

The Loader program is about 2K and Saver is just 840 bytes. The manual tells you how you can reduce the size of Loader to 1.35K and Saver to 670 bytes by deleting some lines of code. Mostly, you'll be getting rid of prompts, so you'll want to be fairly familiar with the programs before doing this.

As for customer support, there isn't a phone number in either the manual or in the ad. Support, therefore, is by mail. But unless you receive a bad copy of the program, there's not much that can go wrong. And even if it did, you still have the old CLOAD and CSAVE to get you by.

With the advent of disk drives, cassettes will surely go the way of the dinosaur — although probably not as quickly. There's still a large number of people who depend on them. And why not? They hold a lot of data, they're inexpensive and now they're Fast.

— Park Morrison

# Your own Program on a ROM

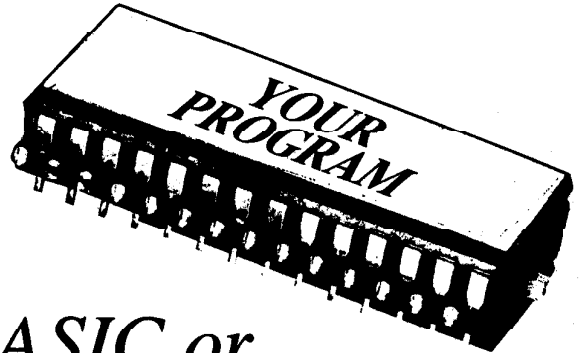

8K or  
32K

Any BASIC or  
machine code

program on a custom  
ROM ready to snap in to  
your Model 100 or  
Tandy 200.

You can't tell your  
program from a built-in.  
Quantity pricing as low

as  
\$49<sup>95</sup>

PORTABLE COMPUTER SUPPORT GROUP

11035 Harry Hines Blvd. No. 207, Dallas, Tx. 75229

1-214-351-0564

VISA / MASTER CARD / C.O.D.

# Calculating Your Costs

A spreadsheet for generating a bill of materials.

By G.N. Gilbert

CUST: MY COMPANY DATE: 01/02/1986 ITEM NO: A200000-001 LD TIME: 2.9  
 TITLE: WIDGET ASSEMBLY  
 ECO LOG BILL OF MATERIAL TITLE: WIDGET ASSEMBLY  
 CUST: MY COMPANY QUANTITY: 10000 LD TIME:  
 REV: 00000-001 ECO NO: 1 REV: 1 ECO NO: 1 DATE: 1  
 REV: 1 ECO NO: 1 DATE: 1  
 WIDGET ASSEMBLY  
 ITEM PART NUMBER U/M DESCRIPTION QTY COST U/M ASSY 6 ORDER  
 NO 1 A200000-001 10000 5.00 10.00 1.00 5.00 5.00 5.00  
 SLEEVE 10000 1.00 1.00 1.00 1.00 1.00 1.00 1.00  
 PRICE/QTY

GRAPHIC BY ELIZABETH MARTINO

A bill of materials (BOM) is simply a parts list that contains certain information that allows you to plan materials ordering. Another way to describe it is as a list of all parts and materials that go into an assembled product. It shows the quantity of each part needed to make one assembly. There are several types of BOMs: indented bills, single-level bills, level-by-level planning bills and quick deck bills. We'll develop the format for a single-level bill of material.

A single-level bill is for products built on a progressive production line. Usually it doesn't have sub-assemblies. More than likely, it's a sub-assembly of some other part. However, once you understand the concept behind this type of bill, you'll be able to develop the other types easily.

Everything that's manufactured, no matter how simple, has some sort of a BOM. The engineering department usually creates one during the design cycle. The manufacturing department then takes the BOM, designs a method to build that assembly and determines the amount of time it will take to construct one unit. This information is then used to calculate the cost of the final product.

Our format will consist of six sections:

1. Body
2. Title Block
3. ECO Log
4. Continuation Page
5. Tables
6. Formulas

### THE BODY

The first thing we must do is layout the order in which we want our columns to appear and determine the width of each. The remaining sections will then be designed to fit around what we've just done. Here are the widths we'll use:

Column	Width	Column	Width
A	6	I	N/A
B	15	J	9
C	8	K	9
D	15	L	9
E	6	M	9
F	9	N	9
G	9	O	9
H	9		

Columns A through H are used in

the printed format of our bill. Columns J through O will contain data necessary for the requirements portion.

Once you've made the columns the correct width for our example, return the cursor to A1. The following is a list of our column headings:

A2 ITEM	F3 U/M
A3 NO	G2 COST
B2 PART NUMBER	G3 ASSY
C2 U/M	H2 QTY
D2 DESCRIPTION	H3 ORDER
E2 QTY	J2 LT
E3 PER	J3 WKS
F2 COST	M2 PRICE/QTY

Now go back to A1 and insert 13 rows by pressing F4. The screen will show "Row Col"; press F1 for row. The bottom line will clear and say: "Range A1:A1." Edit the destination row so it reads: "Range A1:A13." Press Enter and Lucid will add 13 rows.

### TITLE BLOCK

The printed portion of our BOM is 77 characters wide. (This is the total of the widths of Columns A through H). Center the title, **BILL OF MATERIAL**.

Move to A2 and type DATE:. In B2,



press F1 (EDIT), and then Control D for the current date. With the cursor on C2, press the space bar twice and type *P/N*. If your part number does not begin with a letter, be sure to add an apostrophe (') at the beginning of the number so it won't be treated as a decimal number. For example, if your part number includes a dash such as 29000-001, Lucid will print 28999.00 if you don't add the apostrophe.

Type in a part number of your own in D2. Now go to F2, tap the space bar eight times and type *LABOR HRS*. Let's assume this particular assembly will take four and a half hours to build; type 4.5 in H2. Move your cursor to C3, tap the space bar once and type in *TITLE*, and in D3 type *Widget Assembly*. Because Lucid allows us to overflow the column widths, you're not limited to the width of Column D, which is 15. Since nothing appears in Columns E and F, your title of the assembly can be up to 30 characters long.

A little side note is necessary here. Assume for a minute you have some notes you would like to include in the spreadsheet, but don't want printed. Blank both C3 and D3 by tapping the space bar. Remember Column C is eight characters wide. Tap the space bar once and type *TITLE* — but don't press Enter yet. Instead, tap the space bar twice and type *Report by Gil*. Now hit Enter and you can see the entire line. Move to D3 and type *Widget Assembly* and press Enter. Return to C3 and you'll see that *Report by Gil* is covered up. But the words are actually still there. Keeping your cursor on C3, press F1 (Edit) and the full contents of cell C3 will be displayed. This is a simple way to add special notes to yourself.

## ON WE GO

In G3, press the space bar six times and type \$:. In H3 we'll develop a formula to tell us what the labor hours we enter in H2 will cost.

The formula will be our average wage rate times the hours needed to assemble the product. Let's assume our average wage rate is \$6.50 per hour. This wage rate does not include overhead; only the departmental or plant average rate. The formula is  $+(6.5 * H2)$ . We're now up to the last line of our heading.

Move to A5 and type *CUST*. In B5 type in the customer's name, in this case *MY COMPANY*. Again, since nothing is in C5, the customer name can be up to 23 characters long.

In D5, hit the space bar twice and

type *QUANTITY*. The actual amount is entered in E5 — for our example use 10,000. We want this number to be an integer, so press F7 (Sel) and then Enter when the screen says E5:E5. Press F1 (DISP), followed by F2 to reset the number of decimal places. At the prompt, backspace to erase the two and replace it with a zero. Press ENTER and then F7 to eliminate the comma. Return to the form using F8.

Once this is completed, move the cursor to G5 and type *LD TIME*. When we get to the table section of our program, we'll return to H5 and input a formula to tell us the maximum lead time we can expect.

## THE ECO LOG

Before we get into designing the ECO Log, perhaps I should explain its function. When the product is first designed and the BOM written, it's designated as Revision A. When subsequent changes are made to the BOM the revision letter changes, becoming Revision B. These changes can be anything from a change in the value of a resistor to an increase in the quantity needed to manufacture one assembly. This particular portion of the BOM has no formulas, it's strictly informational. But it provides a history of the changes made to the product since its inception.

With the cursor in A7, type the title for this section: *ECO LOG*. Next type in the following:

COLUMN	INPUT
A9	REV...
B9	....ECO NO....
C9	..DATE..
F9	...REV...
G9	..ECO NO..
H9	..DATE...

The dots represent spaces, there's no need to type them.

You should now have three blank lines before the beginning of the Body Section. If you don't, insert some lines. Also, if you anticipate more than six changes you'll need to add some more blank lines — and probably get yourself a new engineer.

## THE TABLES

A table or TBL is similar to a LOOK-UP or CHOOSE in other spreadsheets. It allows us to have two inputs, and Lucid, in turn, will find one input on

the x axis and the other on the y axis and return whatever is in the cell where the two cross.

The table can be located anywhere in the spreadsheet. Ours will be in Columns K through O. It will be used for pricing parts for various quantities or price breaks. Let's begin by typing in some quantities. Move the cursor to L17 and type in 1,000. Enter the value 5,000 in M17, 10,000 in N17 and 25,000 in O17. For the time being, we're going to assume we'll use only the first page. Go to K18 and type in the formula  $*A18$ ; in K19 type  $*A19$ ; in K20 type  $*A20$  and so on down to K58. Right now, the result you get will be zero since we haven't added any data to Column A. Column K is for the Item Number, or line number of the component in the Parts List. Another way to do the same thing is to type a 1 in K18, move the cursor to K19 and type  $*K18*1$  and replicate this down to K56. This will be explained later in this article.

In Column L replicate the number 1 from Row 18 through Row 58, replicate a 5 in Column M, a 10 in Column N and a 25 in Column O. We'll use these figures to represent prices for our materials for the different quantities. Notice that K17 is left blank. This is a requirement in the construction of the table.

During the quote process, you'll be asked to find the current price for each of the components. Price is usually based on the quantity you're going to buy. If a customer wants a quote for 10,000 pieces, chances are he would also like to know the price breaks for one quantity break lower and one quantity break higher. That's what these columns represent.

Later, when we enter the formula in Column F, the price that relates to the quantity in E5 and the individual Item Number will be returned to Column F.

## THE FORMULAS

At the time we are requesting prices from our suppliers, we also need to determine the lead time from the time we place the order to the time we receive it on our dock. This information will go into Column J for each component. Enter some random numbers from 1 to 40 in Column J from Row 18 through 58, making certain you only enter one number 40.

Let's return to H5. This formula will select the highest number or longest lead time in Column J. Once we receive the last part, we'll need an additional two weeks for production. Our formula will look like this:

Text processing power that no other program can equal.

# Write ROM<sup>®</sup>

on Snap-in<sup>™</sup> Cartridge \$99.

**PCSG says "Send it back in 30 days for a full refund if you don't agree."**

WRITE ROM is the definitive word processing extension for the Model 100. PCSG produced the first text formatter for the Model 100, now sold by Radio Shack as Script 100. Now, 18 months later, PCSG introduced WRITE ROM. Those who have experienced it say WRITE ROM literally doubles the power of the Model 100.

WRITE ROM — as its name implies — is on a snap-in ROM. You simply open the little compartment on the back of the Model 100 with a quarter and press WRITE ROM in. It's as easy as an Atari game cartridge. You can use other ROM programs like Lucid whenever you wish.

WRITE ROM lets you do every formatting function you'd expect, like setting margins, centering, right justifying and creating headers and footers. But it does them under function key control.

WRITE ROM remembers your favorite format settings so you can print a document without any setup, but you can change any formatting or printing parameter instantly with a function key.

WRITE ROM's "pixel mapping" feature shows you an instant picture on the screen of how your printout will look on paper.

In all there are 64 separate features and functions you can do with WRITE ROM, and some of these features are truly breakthroughs for the Model 100.

First, WRITE ROM lets you do search and replace. Any word or phrase in a document can be searched for and replaced with any other phrase where the search words appear.

Second, WRITE ROM lets you send any text (formatted or not) to any other computer over the phone with just a function key. What's more, it dials and handles sign-on and sign-off protocol automatically.

Third, WRITE ROM has a wonderful feature called Library that lets you record favorite phrases, words or commonly used expressions (often called boilerplate).

Any place you wish Library text to appear you just type a code. WRITE ROM automatically inserts the text just like a Xerox Memory Writer. Picture what you can do with that kind of capability.

WRITE ROM is blindingly fast. No one can claim faster operation. Because it is on ROM it uses virtually none of your precious RAM. It works with any printer, serial or parallel. You can make a duplicate copy of a document file under a new filename. Rename or delete (kill) any RAM file with function key ease.

This description only scratches the surface of this amazingly powerful piece of software. Dot commands allow control of such things as margins, centering, line spacing and other changes in the middle of a document. Most are WordStar<sup>™</sup> compatible.

A mailmerge feature allows you to send the same document to every name on your mailing list, personalized for each recipient.

WRITE ROM enables you to do underlining, boldface and correspondence mode as well as any other font feature like superscripts that your printer supports, in a way that many users say "is worth the price of the program."

To underline you don't have to remember a complicated printer code. You just type CODE u, and to stop underline, CODE u again. The CODE key is to the right of your spacebar. Boldface? CODE b to start and stop. Easy to remember and do. Five different printer features of your choice.

We couldn't list all the features here. For example, you can select not just double space but triple or any other. You can use your TAB

key in a document. WRITE ROM allows you to indent. This means you can have paragraphs with a first line projecting to the left of the rest of the paragraph. WRITE ROM has a feature unique for any word processor on any computer. It's called FORM. FORM is an interactive mechanism that lets you create screen prompts so that you or someone else can answer them to fill out forms or questionnaires.

With FORM, any place that you had previously typed a GRAPH T and a prompt in a document, WRITE ROM will stop and show you that prompt on the screen. You can type in directly on the screen and when you press F8 you see the next prompt. It goes to a printer or a RAM file.

Think how you can use FORM. A doctor or nurse could use it for a patient's history with each question appearing on the screen. An insurance salesman could use it for his entire questionnaire. You could construct a series of prompts to answer correspondence, typing the answers, even using Library codes. This feature lets you answer letters in rapid-fire fashion, each with personalized or standard responses.

Before WRITE ROM you had to be a programmer to create a series of prompts. Now it's as simple as GRAPH T.

PCSG makes the claim that WRITE ROM is the easiest, fastest and most feature-rich formatter for the Model 100. We're happy to offer WRITE ROM because it expands the 100 to a dimension of text processing you cannot equal on even larger computers.

We brashly state that WRITE ROM is the best you can buy. But put that to the test. If you aren't as excited as we are, return it for a full refund. Priced at \$99. on snap-in ROM. MasterCard, VISA, American Express and COD.

PORTABLE COMPUTER SUPPORT GROUP

11035 Harry Hines Blvd. No. 207, Dallas, Tx. 75229

VISA / MASTER CARD / AM. EXP. / C.O.D.

1-214-351-0564

**Now get portable power working for you with the magazine for users of Tandy portable computers — Portable 100**

**Order your subscription. Call TOLL FREE 1-800-225-5800 now!**

**Foreign Rate Information:**

Canada and Mexico — Please enclose \$33.97 in U.S. funds.

Europe and all countries except above — Please enclose \$38.97 for surface delivery, \$53.00 for air delivery.

*Save Save*

**YES!** Start my subscription to PORTABLE 100 for \$29.97. That's 12 big issues and I save 37% of the regular newsstand rate! And my subscription is guaranteed.

**CALL TOLL FREE 1-800-225-5800**

Check or M.O. enclosed  
 Charge \$29.97 to my  
 MC,  VISA  
Card # \_\_\_\_\_  
Exp. Date \_\_\_\_\_  
 Bill Me later (U.S. only)

Signature \_\_\_\_\_  
Name \_\_\_\_\_  
Company (if applicable) \_\_\_\_\_  
Address \_\_\_\_\_  
City \_\_\_\_\_ State \_\_\_\_\_  
Zip \_\_\_\_\_

J86A

*Save Save*

**YES!** Start my subscription to PORTABLE 100 for \$29.97. That's 12 big issues and I save 37% of the regular newsstand rate! And my subscription is guaranteed.

**CALL TOLL FREE 1-800-225-5800**

Check or M.O. enclosed  
 Charge \$29.97 to my  
 MC,  VISA  
Card # \_\_\_\_\_  
Exp. Date \_\_\_\_\_  
 Bill Me later (U.S. only)

Signature \_\_\_\_\_  
Name \_\_\_\_\_  
Company (if applicable) \_\_\_\_\_  
Address \_\_\_\_\_  
City \_\_\_\_\_ State \_\_\_\_\_  
Zip \_\_\_\_\_

J86B

**portable 100**

*SPECIAL OFFER!*

Please send a one-year gift subscription to PORTABLE 100 to the person named below. I've enclosed \$22.97, a full 23% discount off the regular subscription price and 52% off the regular newsstand price.

**Send gift to:**

Name (Please print)	Your Name
Company	Company
Address	Address
City State Zip	City State Zip

J86C

**portable 100**

This offer is too good to pass up! Please  renew or  start my subscription for only \$22.97.

Renewals: write subscription number from mailing label here: \_\_\_\_\_  
**Payment must accompany order!**



# Tandy MS-DOS Users Subscribe to PC Companion Magazine your monthly magazine for...

Complete coverage of Tandy's MS-DOS computers — the Tandy 1000, 1200, 2000 and 3000. PC COMPANION will bring you the power you need to make your Tandy MS-DOS computer work to its full capacity. Inside every issue of PC COMPANION you'll find :



**Reviews** — "The 3000 — Tandy Targets Power Users"  
"Buyers Guide to Integrated Software"  
"Database Management and Analysis"  
"Comparing the Porsche and Cadillac of Word Processing"  
"An Introduction to Project Management"



**Applications** — "The Tandy Partnership: Start a Business at Home"  
"The 1000 Down on the Farm"  
"Computer-aided Design with the Tandy 2000"  
"Legal Briefs: Time Billing with the 1200HD"  
"Accounting for Small Business"



**Issues** — "Uncle Sam Can Pay for Your Tandy System"  
"How to Hire a Computer Consultant"  
"Off-the-Shelf or Custom: The Programmer's Dilemma"  
"How to Get Rich in Software"  
"Kicking the Dog: Selling Your Used Computer"



**Columns & Departments** — "Making Money at Home"  
"Educational Computing: A Parent's Guide"  
"Doctor DOS"  
"New Hardware, Software and Peripherals"  
"Programming Notebook"

And there's more in every issue  
of PC Companion

To receive every important issue of PC COMPANION, just fill out the coupon below and send it in today! It's just \$24.97 for 12 monthly issues (Special Charter Rate.) And if you're not completely satisfied, we'll refund the unused portion of your subscription — no questions asked! Do it today!

Send this coupon to:  
**Camden Communications Inc.**  
P.O. Box 250  
Camden, ME 04843

**YES!** I want to receive PC COMPANION every month. Sign me up for a one year, risk-free Charter subscription — only \$24.97 and I save over 52% off the regular newsstand rate.

Check or MO (\$24.97) enclosed  Please Bill Me

Please Charge my \_\_\_ MasterCard \_\_\_ VISA

Card No \_\_\_\_\_ Exp. Date \_\_\_\_\_

Signature \_\_\_\_\_

Name \_\_\_\_\_

Address \_\_\_\_\_

City \_\_\_\_\_ State \_\_\_\_\_ Zip \_\_\_\_\_

# SPREADSHEET

BILL OF MATERIAL							
DATE: Apr 02, 1986	P/N: A200000-001	LABOR HRS:					
	TITLE: WIDGET ASSEMBLY	\$:		0.00			
CUST: MY COMPANY	QUANTITY: 10000	LD TIME:		2			
=====							
ECO LOG							
REV	ECO NO.	DATE	REV		ECO NO.	DATE	
-----							
=====							
ITEM NO	PART NUMBER	U/M	DESCRIPTION	QTY PER	COST U/M	COST ASSY	QTY ORDER
1	A200000-001	FT	SLEEVING	0.50	10.00	5.00	5000

A sample bill of material.

L/T	PRICE/QTY					
	1000	5000	10000	25000		
5	1	1.00	5.00	10.00	25.00	
7	2	1.00	5.00	10.00	25.00	
1	3	1.00	5.00	10.00	25.00	
4	4	1.00	5.00	10.00	25.00	
3	5	1.00	5.00	10.00	25.00	
9	6	1.00	5.00	10.00	25.00	
6	7	1.00		10.00	25.00	
4	8		5.00		25.00	
5	9			10.00		
33	10				25.00	

Set up a separate table for quantity price breaks.

+MAX(J18:J56)+2

Now it's time to go to the Body section and add some data and some formulas. Let's move to A18. We'll need to add our item or line numbers. In A18 type 1. In A19 type  $\times A18 \times 1$ . Replicate this formula to A56. We want these to be integers, so follow the same procedure to remove decimal places as before.

Column B is for our Part Numbers, so type in one of your own. U/M in Column C stands for Unit of Measure. If we use something like sleeving or tubing, it's usually sold in feet or inches. Screws and bolts are sold individually. This information will be used when we ask for a price quote from our supplier or when we place an order.

Assume that the part is normally sold in feet and type Ft in C18. Column D is description; my only advice here is to keep it simple and be consistent with your abbreviations. QTY PER in the next column is the amount needed of this item to build one assembly. Type in the quantity .5 in E18, which in this case means we'll use six inches. Column F will use the table we created in Columns K through O. Type in the formula:

+TBL(A18,E5,K17:O56)

The formula will look to see what numbers are in A18 and in E5 and go to the table located in the area K17 to O56. The price is located where the two values cross and is displayed in cell

F18. We need to replicate this formula down to F56.

You must note, however, that if we replicate the formula as it is above, the A18 will change to A19, the E5 to E6, and K17:O56 will change to K18:O57. That's not what we want. So go back and change the formula to read:

+TBL(A18,\$E5,\$K17:\$O56)

The \$ tells Lucid not to change those cells during the copy phase. This is called Absolute Cell Reference. If it changes as it does in some of the other formulas, it's called Relative Cell Reference.

The formula for Column G is Column E multiplied by Column F. (i.e.  $+E18 \times F19$ ). Go ahead and replicate this formula to G56. Column H is the quantity in E5 times Column E. Remember, we don't want E5 to change, so the formula is simply  $+\$E5 \times E18$ . Replicate this to H56. Now go to Column G and total the column with the formula  $+SUM(G18:G56)$ .

Return to the top of the Body Section and enter in some data in Columns B through E in Rows 19 to 29. Press F2 (CALC). Print this BOM, and then change E5 to 5,000. Press CALC again and print this version. Now you can play the "What if..." game for different quantities. Our BOM gives us material and labor costs, and the quantity of each item to order.

## A FINAL WORD

Much of what we just covered is in the Lucid manual, but I've tried to present it in a slightly different way to give you another perspective of the concepts.

Next month we'll present a Manpower Planning Report just in time for your budgeting process. This format will help you plan your manpower, make adjustments for overtime and help determine when to hire, transfer or layoff employees. Lastly, it will provide you with some financial information for the budget. □

*This is the third in a series of articles about using spreadsheets in business.*

*This particular format was designed to be used for a custom-designed product, but it can be adapted for other products. Although the information obtained from this form will be used in our Product Quote format later in this series, it can be also used quite effectively as a stand-alone document.*



PHOTOGRAPH BY BENJAMIN MARGRO

# Keeping Track

*A proven business expense manager goes public. Here's a simple program for keeping tabs on tabs.*

By Ray Hoskins

**F**or those who travel with a Tandy, NEC or Olivetti portable computer, Trip is a compact and convenient BASIC program for keeping detailed expense account records and notes on business or recreational trips. The program's note format is suitable for recording appointments, reminders and trip reports.

First we'll discuss what the program does and then, for you programming buffs, we'll get into the more technical aspects of the program. There are some small differences in the BASIC language dialects used by the various computers. These differences will be pointed out where appropriate.

Trip maintains a cumulative total of expenses to date. A special provision is made in the car expense account to save odometer readings for calculating miles traveled and reimbursement information. Similarly, the odometer reading, cost of gas and number of gallons at each "fill-up" may be entered and miles per gallon computed and re-

corded. Records are arranged by account for review or printed reports.

The program starts by displaying the main Trip menu:

Trip by Ray Hoskins

- 1 Initial
- 2 Input
- 3 Review
- 4 Print
- 5 Exit

Select the operation you want by typing the corresponding number key. After each operation is complete, the program returns to this menu — unless you select 5 to exit and return to the computer menu. The other operations are described below.

**1 Initial:** The program maintains a summary file (STR.DO) of general trip data and current values. The first time you use the program or when starting a new set of records it's necessary to *initialize* this file before performing other operations. This procedure may also be

used to make subsequent changes in the data. Prompts will appear for each data item and the current value, if any, will be displayed on the line before the ? prompt. Examples are shown after the ? prompt to illustrate a typical entry. The first prompt is:

Description:

?January 20-24, Trip to Memphis

Respond with a brief (60 character maximum) identification of the trip. The next prompt is:

Purpose:

?Meet with potential clients

Enter a brief description of the purpose of the trip — in 60 characters or less. If you want the program to automatically calculate the number of miles traveled for computing gas mileage or reimbursement, enter the odometer reading at the beginning of the trip in response to the prompt:

*Text continues on page 56*



# TEXT POWER™ 100/102

Portable 100 Magazine: ... "THE BEST FORMATTER THERE IS FOR THE 100" ... is even better than ever!

- After more than 2 years, still the most compact and still the best text formatter! Packed with powerful features not found in word processors on some desktop computers. TEXT POWER uses less than 2.7K of precious RAM, and is written 100% in machine language for speed and efficiency.
- Now available in both parallel and serial versions, with optional support for International/French characters.
- Optional compatibility for Disk Video Interface, Tandy portable drive (FLOPPY.CO) or Chipmunk drive.
- TEXT POWER supports the following features: Footers and Headers that can be turned on/off or changed from within text, Page numbering, Tab characters, MERGE TEXT™, Right Justification, Centering, Left & Right margin control with "in-file" commands, and much, much more...
- TEXT POWER also supports the following printer independent, easy-to-use embedded control commands:

- |                   |        |                         |        |                    |
|-------------------|--------|-------------------------|--------|--------------------|
| ^ B Boldface      |        | ^ F Near Letter Quality | 10 cpi | ^ U Undeline       |
| ^ C Condensed     | 17cpi  | ^ G Near Letter Quality | 12 cpi | ^ W Wide/Extended  |
| ^ D Double Strike |        | ^ H Super Script        |        | ^ N Microfont      |
| ^ E Elite         | 12 cpi | ^ L Sub Script          |        | ^ R Red or Italics |



```

1.42 CHUGO
Apr 28, 1986 Mon 21:35:07
TEXT POWER 100
B Copyright 1985 Hugo Ferreyra
8 66 80 6 6 0 N
Done Left Page Page Top Bottom Right Stop
    
```

## • SET MENU

At the stroke of a single function key, each of the displayed vital parameters can easily be modified. There is no need to reset parameters each time a document is printed, since TEXT POWER "remembers" the previous values stored. And TEXT POWER conveniently sets default parameters for standard usage.

```

Pass Page
1 1
TOP TEXT BOTT.
5 58 3
R/W/P/D
    
```

## • PAGE PLOT™

The most powerful and time-saving feature that exists in text formatters for portable computers today! You can graphically see your formatted text before printing! And Hugo Ferreyra set the standard by inventing and implementing PAGE PLOT™ first in TEXT POWER 100, before Write-Rom, Lapword, T-Word or any others!!!

```

#####And so John, I would recommend
TEXT POWER 100 as the best
print formatter there is for the MODEL 100
and the new TANDY 102.
Pass Page TOP TEXT BOTT.
1 1 4 57 5
R/W/P/D
    
```

## • DISPLAY FEATURE

Before printing, view all the headers, footers, tabs, centering, merges, page numbers, and the actual formatted text without any of the embedded commands. Scrolling can be halted or resumed at any point, and important format information is shown at the end of every page.

### Now even better. Improvements in TEXT POWER 100 Version 1.42 over Version 1.38:

- TABs are fully supported, shown during plot and replaced with the correct number of non-breakable spaces.
- TEXT files can be accessed or created from within TEXT POWER for increased versatility.
- FORM FEED your printer directly from within TEXT POWER's Main Menu by pressing the (LABEL) key.
- PROGRAM FLOW is even more consistent for all functions, with vital parameters displayed after each page.
- PASS COUNTER implemented to help recognize which copy is being processed when merge is in use.
- DOUBLE SPACE now selected as an "in file" command to turn the feature ON or OFF anywhere during printing.
- FOOTER & HEADER handling is simplified & easier to use.
- "Plot" is improved and now shows page boundaries when there is room on the screen.
- (.DO) files only are listed when entering any function, with a default filename proposed to save typing.
- START & STOP file processing anywhere within the text, using this embedded command.
- LINE FEED support is now set internally within TEXT POWER. No need to rely on external utilities like FIXLF.
- (ESC) in almost every situation can be used to abort any TEXT POWER function.
- ERROR HANDLING is improved. For example, PRINTER NOT READY error does not "HANG-UP" your Model-100 but instead beeps to warn you of the situation.



# DISK POWER™

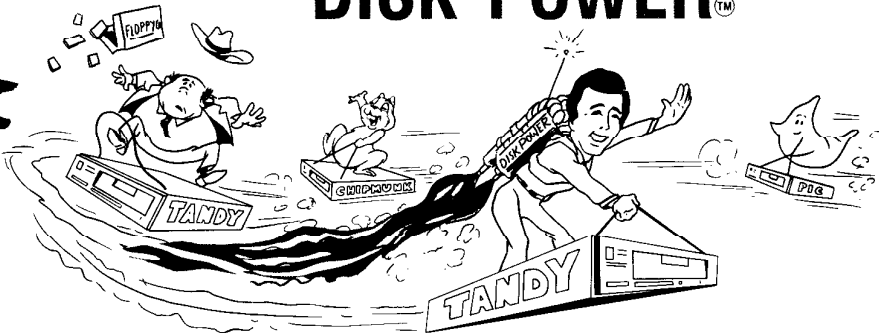

DISK POWER 100/102/200 is a stand-alone Disk Operating System for the Tandy Portable Disk Drive that completely replaces FLOPPY.CO, and comes with an extension to BASIC which can be loaded only when needed. It has operational & size advantages over any other operating system on the market.

## • RAM DIRECTORY:

- 80 character "WINDOW" feature for .DO or .BA files. Also displays TOP, END, EXE addresses for .CO files.
- Number of bytes occupied by an unsaved BASIC program.
- Number of characters in the PASTE buffer.

```
FLOPPYc TSCRAPc LOADERb RAMKILb DATA d
NOTES d TEST b DP100 c BUGGERc SAVRAMb
ENTERg BUDGETb SD100 c ----- 1261
DISK POWER 100 (C) 1986 Hugo Ferreyra
Montreal, March 29 1986 Dear custom
er. Enclosed you will find the last
BAS= 288 PSI= 547 HIM=49152 FRE=2791
```

- File length of highlighted file.
- 7 lines of actual text packed into the two line window. <<<
- Total FREE bytes available.
- Value of HIMCM

## • DISK DIRECTORY:

- In both directories, filename extensions replaced by a single lowercase character. No waste of screen space on redundant information. This allows all 40 disk files to be displayed at once! No scrolling necessary.
- Exclusive multiple file selection feature via single keystroke, to perform any task on upto 20 files at once!
- "ALL" function key automatically selects as many as 20 files, beginning at the current cursor position, to allow Load "ALL", Save "ALL", Kill "ALL", etc.

```
BUDGETd BUGGERc CALC b CHPTR1d CHPTR2d
CHPTR3d+CHPTR4d CHPTR5d CHPTR6d+CONTRCd
DATA d DP100 c+KILBUGc KILLERb LETTERd
MONITRb NOTES d SAVSAVc+SAMPLEd SCRIMPb
SORT c WALKERd+TEST d TP100 c -----
```

## • EXTENSION TO BASIC:

- OPEN disk data (.DO) files for input, output or append. Commands such as EOF, Print, Input are implemented. Full support for Load, Save, LFiles, Merge, etc.
- All the extended functions of DISK POWER BASIC use similar syntax to existing commands, so that your favorite BASIC programs could be converted to take advantage of the Portable Disk Drive in seconds!
- DISK POWER provides built-in protection against system crashes when users try to perform two different disk functions at the same time!

## • EXTENSION TO TEXT:

- Load & Save disk .DO files from within TEXT and TEXT POWER, using the familiar F2 & F3 function keys.

## • EXTENSION TO TELCOM:

- Direct access to BASIC & TEXT from inside TELCOM. Kill, Load, Save or Edit files without losing telephone communications. You can even see your files while uploading. With DISK POWER, it is all possible!

## • 24 HR. BBS SUPPORT HOTLINE:

- Using STAT: M8N1E, ID: Disk, PW: Power (514) 457-2917

**DISK POWER is the only Disk Operating System which provides all of these INNOVATIVE features. Written 100% in machine-language to make it ULTRA-fast.**

**TEXT POWER 100/102**

**\$49.95 US**

**DISK POWER 100/102/200**

**\$49.95 US**

or SAVE by buying the **ULTRA POWER** program pack: DISK POWER/TEXT POWER 100 FOR ONLY **\$89.95 US**

To order **TEXT POWER**, specify configuration and printer(s) used. The basic price includes support for one printer. Please add \$10.00 for each additional printer you wish supported. All U.S. orders shipped from within the USA. Absolutely no custom forms, sales tax or duty required. Add \$3.00 S&H to each order. Send your original cassette to the address below, and receive an updated version of **Text Power** (V. 1.42) for only \$24.95 U.S. plus S & H.

No surcharge for VISA or MC To order, call **TOLL FREE:**

USA (Except N.Y.) **1-800-448-4511 Ext. 313** NEW YORK STATE ONLY **1-800-962-1480 Ext. 313**  
ONTARIO & QUEBEC **1-800-255-1133 Ext. 313**

or send CHECK or MONEY ORDER to:



**ULTRASOFT INNOVATIONS**

P.O. Box 219, Ste. Anne de Bellevue, Québec  
CANADA H9X 3R9 (514) 457-9293 (9-5 EST)

Ultrasoft and Ultrasoft logos are registered trademarks of Ultrasoft Innovations Inc. Other Trade Marks: Tandy - Tandy Corp., Write-Rom - P.C.S.G. INC., T-Word - Travelling Software Inc., Lapword - Jim Irwin, Chipmunk - Holmes Eng.

# The Power of Light

*Is it on? Is it off? A do-it-yourself solution to a portable disk drive problem.*

By Arthur Gooding



PHOTOGRAPH BY BENJAMIN MACURO

I've been using Tandy's portable disk drive for several months now, and while it performs as expected, I have a disconcerting habit of leaving it turned on and thus causing the batteries to run down. The drive doesn't have an automatic power down feature and no indicator light to show whether it's on or off.

After the fifth or sixth time of finding the batteries dead, I decided to do something about it. Since an indicator light was easier to install than a power down circuit, I opted for simplicity.

Radio Shack sells a red blinking light-emitting diode or LED (part number 276-036B) that lights at five to seven volts DC and consumes 20 milliamps for only \$2.49. All you'll need is one of those, a Phillips-head screw driver, a small drill and a soldering iron. All that has to be done is to attach it to the power bus after the power switch.

The first thing to do is remove the batteries and disconnect the power cord. To open the case, turn the drive

upside down and remove the screws at the back end. Turn it right side up and lift the cover from the rear. The top should slide off.

To remove the front, flip the drive over again, placing it carefully on a clean sheet of paper. Take care no dirt gets in the unit. Remove the two screws inset in the black front cover. Turn the drive right side up and gently pull off the front. Be careful not to lose the two plastic switch covers (power and floppy eject). A sharpened toothpick inserted beside the eject button will keep it from falling out.

It's also important not to press the eject button while the drive is disassembled. You could damage the head mechanism.

Now you're into the unit as far as you'll need to go. Note the small circuit board at left with the battery indicator LED on the top left corner. We're going to install the power LED immediately to the right of it.

Note where the wires go on the back

of the circuit board. Taking care to avoid hitting those wires, drill two small holes with a 1/32 inch drill bit in the clear area next to the battery LED. Push the wires of the new LED through the holes.

Now you can remove the small circuit board to solder the LED leads. The board is held on with two small screws. Remove them and wiggle the board towards you gently. Cut some plastic spaghetti to length and push onto the legs of the LED, then bend the legs over as shown, keeping them at least 1/16 inch off the circuit board. Then bend the ends down until they touch the exact spot where you want them to be soldered.

The soldering is tricky. You want to make a good physical connection without shorting the existing connections.

This can be done with a dry tinned pencil iron, just touching the iron to the solder head with the LED lead resting on the soldering bump. When the



# POWER LIGHT

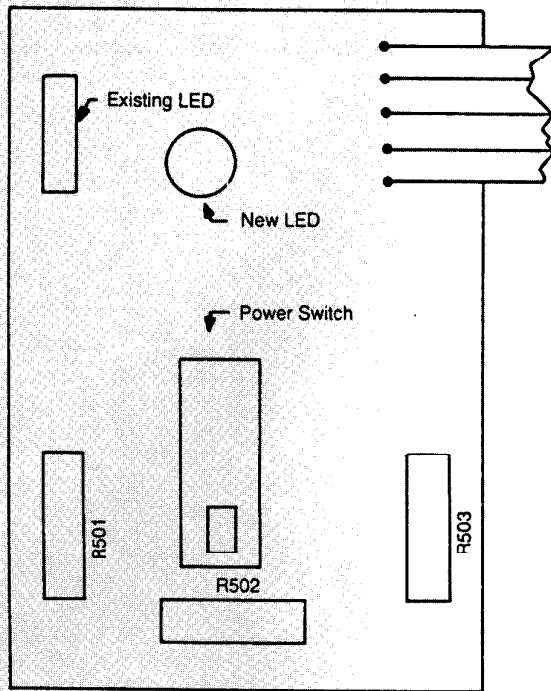

Front view of the circuit board showing location of new LED.

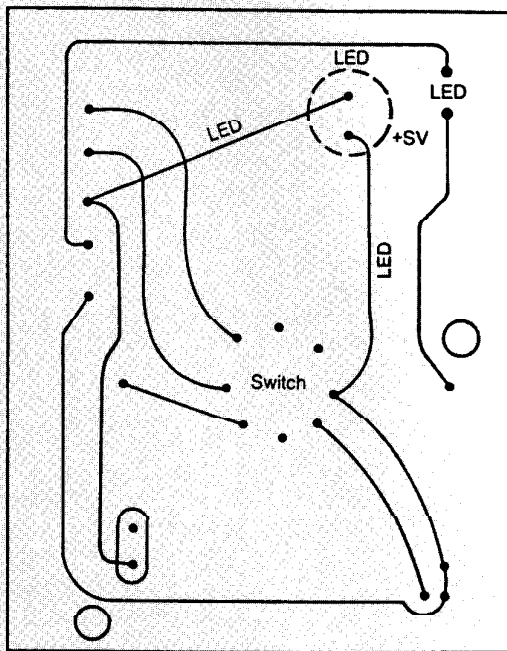

Rear view of circuit board showing wiring connections for new LED.

solder melts, the LED lead sinks into the solder bump and some of the solder goes into the dry iron. If you add solder to the existing solder bump, you may flow over to the adjacent connection, making it necessary to de-solder that section of the board. After soldering, put a small drop of epoxy on the legs of the LED where they go through the circuit board to give them more support. Then screw the circuit board back onto the disk drive.

You're almost finished now. Note where the new LED is in relation to the other. Drill a small hole in the front cover of the disk drive so you can see it. With a small file or reamer, you can enlarge the hole and reposition it slightly if you were off in the drilling.

Now put the case back on. Put in the batteries and turn on the drive. If you wired it correctly, the LED will blink. Check out the drive using the FILE, SAVE and LOAD commands and make sure it is working correctly.

## THINGS TO LOOK OUT FOR

If you drill through the existing wire on the circuit board, you'll have to solder a wire onto the board to replace it. This is difficult but not impossible. It takes some care to keep from bridging or shorting solder connections.

If you get the error DRIVE NOT READY, you haven't got power to the drive. Check that the batteries are inserted properly and that the original LED blinks when you turn the power off.

If your computer says COMMUNICATION ERROR and then the drive powers down, it may indicate not enough amperage in the power supply. My drive will read files on the Model 100 power supply (six volt 200 milliamps) but powers down on writing a file. With four nicads or Duracells in the unit, though, there's no problem. I've been using Radio Shack AA nicads in both computer and disk drive since I purchased the units and never had any problems. I keep four in the charger and replace them when necessary. It's saved me a lot of money in batteries and frees the computer from power cords.

It's important to note that taking the disk drive apart and altering it will void the warranty. So it's a good idea to wait until the warranty has expired before doing this. It's a simple circuit board and easy to rewire if you damage it.

Have fun. □

# THE PORTABLE

## 3.5" MICRO FLOPPY DRIVE

Purple Computing Model D103

\$229 with TS-DOS software for Model 100/200, NEC PC 8201A

\$259 with LAPDOS software for the IBM PC/XT/AT

\$299 with both LAPDOS and TS-DOS



At 28 ounces and 1/3 the size of a Model 100, this disk drive is totally portable. The four size "AA" batteries inside, power the drive for 2+ hours of continuous reading/writing at over 2,000 char./sec. (19,200-baud). Fast random file access to 102,400 bytes means no more waiting for cassettes. The best part is the software—you get your choice of either **TS-DOS** for the Model 100/200 & NEC PC-8201, or **LAPDOS** for the IBM.

For one price we send you everything you need to start using the disk. Even an A/C adaptor (saves batteries when A/C is handy).

### COMPLETELY COMPATIBLE!

The disks, formats, data, and everything else are completely compatible and interchangeable with the TANDY portable disk drive

**TS-DOS** on 3 1/2" diskette for your portable, lets you save and load files with a single key, or save/load all files at once; append files to create one file up to 64K; display or print files directly from disk; access disk files directly from BASIC using OPEN, PRINT #, INPUT #, ...; occupies only 500 bytes when not in use and requires under 5K to run. **TS-DOS** is supported by **ULTIMATE ROM II**.

**LAPDOS** consists of a 5.5" diskette for your IBM PC/XT/AT, manual, and special cable adaptor which lets you hook our Model D103 drive to your IBM's serial port. **LAP-DOS** supports file conversion between: T-BASE ↔ DBASE II and IDEA ↔ ThinkTank, and can run RAM resident!

## A \$99 PRINTER MADE FOR TRAVEL

SIZE and WEIGHT are the most important considerations when going portable. This printer is half the size of the Model-100 and weighs less. Now there's no reason not to have a hard copy printout wherever you are.

### FEATURES

- 2.2 lbs., size 11" x 4 1/4" x 1 1/4".
- Epson MX/80 bit-map. graphics.
- Built-in auto self test function.
- 8 1/2" wide thermal paper.
- Excellent User's Manual.
- 40/80/160 chars./line.
- 512 byte text buffer.
- 40 chars./sec.

### RUGGED

Because it's thermal, there are no ribbons, no ink, no pins to wear out or replace, all you need to take with you is

paper. Prints over two hours on internal batteries and is designed to print over 300,000 lines without maintenance—that's 25 pages every week for over four years!

### DIRECT TO YOU

High volume and no middle man means low price. We buy direct from the Japanese manufacturer in large quantities for our corporate accounts (NBC, PanAm, National Geographic . . . ), that's why we can offer it direct to you at this fantastic price, yet still give you great service and support.

### SUPPORT

We stock paper (rolls and sheets), cables, and accessories for the printer. A complete accessory kit is only \$24 and includes a carrying case, a 100' roll of paper, and the hard-to-find 6VDC @ 1.1Amp. A/C adaptor (saves batteries when A/C is handy).

### \$99 GRAND TOTAL

You get the printer and a specially made 18" cable for your Model 100/200/600 or NEC PC-8201A/8401, a 20' roll of paper, paper holder, and four "C" size batteries—everything you need to start printing immediately.

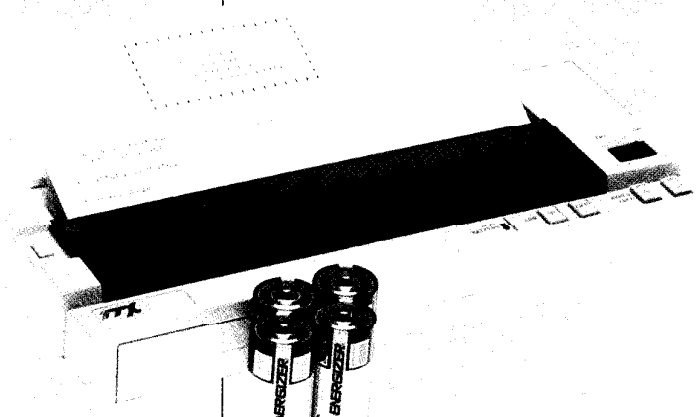

(ACTUAL print sample)  
80 Chars./Line, 40 CPS!  
Enlarged!  
underlined Emphasized!  
CONDENSED gives you 160 chars. per line!



# EXPANSIONS!!!

## NOT "ALL-THE-SAME"

The memory expansion products sold by us, our dealers, and distributors are made by us—here in the U.S.A. We have been making them since 1983 and have more than 50,000 memory expansion units in service worldwide—our dealers and customers tell us ours are the best. You could spend less or you could spend more, but you won't find a better combination of price, quality, and service than you will from Purple Computing, or one of our dealers.

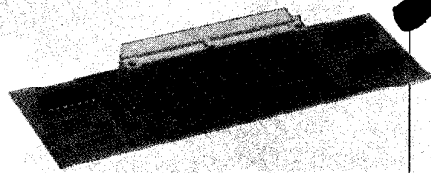

## TANDY 600

**96K Memory Unit**  
\$249—two for \$469

Designed as an alternative to the expansion board that TANDY offers. Functionally identical and easy to install with our complete and detailed documentation—just open the case and plug it in. The basic TANDY 600 machine will accept two of these boards, bringing its internal memory up to 224K (contiguous).

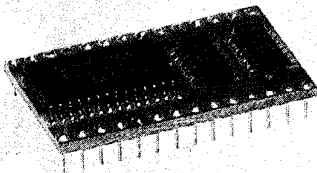

**MODEL 100 or NEC PC-8201A**  
**8K Memory Module**  
\$29 ea., 3 for \$79, 6 for \$149

Easy to install. Open the case and plug-them-in. Each module expands your memory by 8K bytes. Extra low power components mean long battery life. Very low profile means a proper fit in the NEC PC-8201A. Detailed instructions make installation quick and easy. You can expand your Model 100 to 32K and your PC-8201 to 64K (2 banks of 32K each).

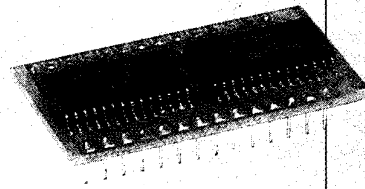

## TANDY 200

**24K Memory Module**

\$75 ea. or two for \$130

**WE'LL BEAT ANY advertised price in this magazine on the 24K Module.**

Simply pop open the hatch with a coin and plug in one or two of these modules. Each module adds a 24K bank of memory to the TANDY 200. It's like getting two more machines. The built in COPY function key copies files between banks instantly. Like our 8K, we build these with the lowest power and most reliable memory chips available.

**NEC PC-8201A**  
**128K RAM CARTRIDGE**  
**THE SIDECAR**  
\$259

Plugs into side expansion slot providing four additional banks of 32K each. The case conforms to the shape of the 8201 extending its width only 2¼ inches. An internal battery backs up the memory for over seven years.

**STARLET (NEC PC-8401A)**  
**128K RAM DISK CARTRIDGE**  
**THE SIDESTAR**  
\$399

Plugs into the side expansion slot providing a 128K RAM DISK that is formatted and used by the STARLET just like a floppy disk drive—except it's hundreds of times faster, and you don't need a drive, cables or A/C power. Lets you use 64K mode and run larger programs like DBASE II. The expansion connector lets you copy large files (up to 124K) between disk and SIDESTAR using NEC Disk/Video interface. An internal battery backs up memory for over seven years.

When you order, ask for the CP/M utilities and we will load them into your SIDESTAR at no extra charge. (Includes DDT, ED, ASM, LOAD . . .)

## THE PURPLE POLICY

Try any of our products for 30 days, satisfy yourself that our service, quality, and prices add up to the best value anywhere—if not completely satisfied, you can return the product for a full refund. Join our (over 20,000) satisfied customers. All prices include free UPS surface shipping, and there are no surcharges for VISA/MC/American Express—even the phone call is free.

## IT'S EASY TO ORDER

Send your order with payment to the address below. Or, if you prefer, credit card orders can be handled by phone—VISA, MasterCard, and American Express are welcome. California residents add 6% sales tax. Checks allow 3 weeks to clear. Institutions and Corporations call for purchase order approval.

**1-800-732-5012 TOLL FREE**

Orders only (8am-5pm. PST)

In California **(805) 987-4788**

For orders or customer service

If you would like our latest product catalog or to find a dealer near you, please write or call (805) 987-4788

 **PURPLE COMPUTING**

420 Constitution Ave.  
Camarillo, CA 93010  
Telex: 888661 (PURPLE)

Canada: Canada Portable Computer,  
Langley, B.C. (604) 856-8858

Australia: Softech Computer Services,  
Sydney. (2) 419-8899

Trademarks: TS-DOS, LAPDOS, ULTIMATE ROM, IDEA!, T-base, T-Writer—Traveling Software, Inc., ThinkTank—Living Videotext, Inc., DBASE II—Ashton Tatl., CP/M, DDT, ED, ASM, LOAD—Digital Research Inc.



# Laptop Genealogy

*You can research your family tree without purchasing any special software. An outline processor works just as well.*

By Eva P. Thompson



none for use on a portable.

But don't feel left out. You may already have a package on your shelf that works just as well.

The very nature of genealogy — organizing different levels of ancestral data in hierarchical form — makes it perfectly suited for an outline processor such as Ultimate ROM II's IDEA or Super ROM's Thought.

If you're a laptop owner, you may already own a multi-ROM chip and use it for many other applications. But perhaps it didn't occur to you to try your family tree on it using the outline processor. It's simple, even if you've never used an outline processor before. And the portable aspect is fantastic; you can take your laptop to the library and update files as you do the research. Even if your genealogy hobby takes you overseas, you can not only take your favorite research tool, but in it *all* of your past notes and information. (See "Traveling With Your Portable" April, 1986.)

As a newcomer to the laptop world, I was a good candidate to test the user-friendliness of IDEA. Even though I had never tried an outline processor before, I had no problem figuring out the system and entering a

software manufacturers are jumping on the genealogy bandwagon, taking full advantage of the fact that genealogy is one of the fastest-growing hobbies in America. There are programs of all types springing up for different computers, but as far as I know,



couple of generations of my family tree. Thanks to my genealogy-loving relatives, the hardest part was already complete; I didn't have to research a single birth date.

The next hardest part is figuring out where to start. Do you begin with the roots and work outward, or vice versa? Theoretically both ends would keep growing, so there's no clear starting point. I decided to start with grandparents and work my way back in time.

The next challenge is deciding how you want to organize the files themselves. According to the IDEA manual, you can only have 250 files. Although I didn't take it that far, it's conceivable that you could exceed that limit if you had a file for each person in your tree (I counted 200 names on my family tree and was only back to the year 1318. And it keeps going.) But you can have any number of divisions and notes under each file, limited only by the amount of random access memory (RAM). So I did the whole thing under one file — a solution that works but may not be the safest method.

Following the instructions in the manual (I didn't bother listening to the tutorial cassette tape) I entered the file and provided my grandfather's full name at the 1. with reverse type and flashing cursor. The menu





changes to give you two options: Notes and Quit. Once in Notes, you can type as much information as you like about the person: screenfuls, if you have it. I simply used birth and death dates, and occasionally the name of the person he or she married. I didn't mind typing "Born..." and "Died..." each time, but if you want to save keystrokes you can set up a template so you only have to enter the actual dates.

Once you've entered all the information you have about that person, press F8 once to take you back to your outline. To enter that person's spouse, just hit the down arrow key and hit F3 for Edit. You'll see 2. this time, with the reverse type bar and flashing cursor prompting you for the name. After you add information to the Notes file, notice that an asterisk appears after the name. Names without notes will not show the asterisk.

To go to the next generation, first return to the outline, then press F1 (Exp) for expand. Follow this with F3 for edit. The reverse type and flashing cursor prompt you for this person's name, and you continue the process. Notice that a plus sign (+) appears next to a heading that has a subheading under it. As long as you continue to expand your tree, each name will show a plus sign after its level-indicating number.





# GPIB

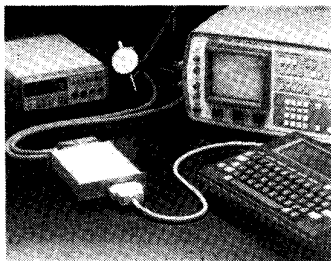

## GPNET model 10

- CPU Z8 Single chip controller (8 MHz)
  - ROM 4KB RAM 2KB
  - GPIB Controller NEC uPD7210
  - RS232C I/O (300-19200bps)
  - IEEE-488 bus connector
  - GPIB function:
    - SH1 AH1 T6 TE6 L4 LE4
    - SR1 RL2 PPO DC1 DT1
    - C1 C2 C3 C4 C7
  - Power Supply: DC 5V 450mA DC 12V 30mA
  - 126mm w x 29 mm h x 151 mm l
  - 18 oz. weight
  - \$350.00
- Does not require specific OS  
Only BASIC needed to support network
- GPNET 12V Power Unit available
- NICTRIX** CORPORATION  
26 Court Street  
Brooklyn, NY  
718-522-4941
- Dealer inquiries invited

## FAMILY TREE

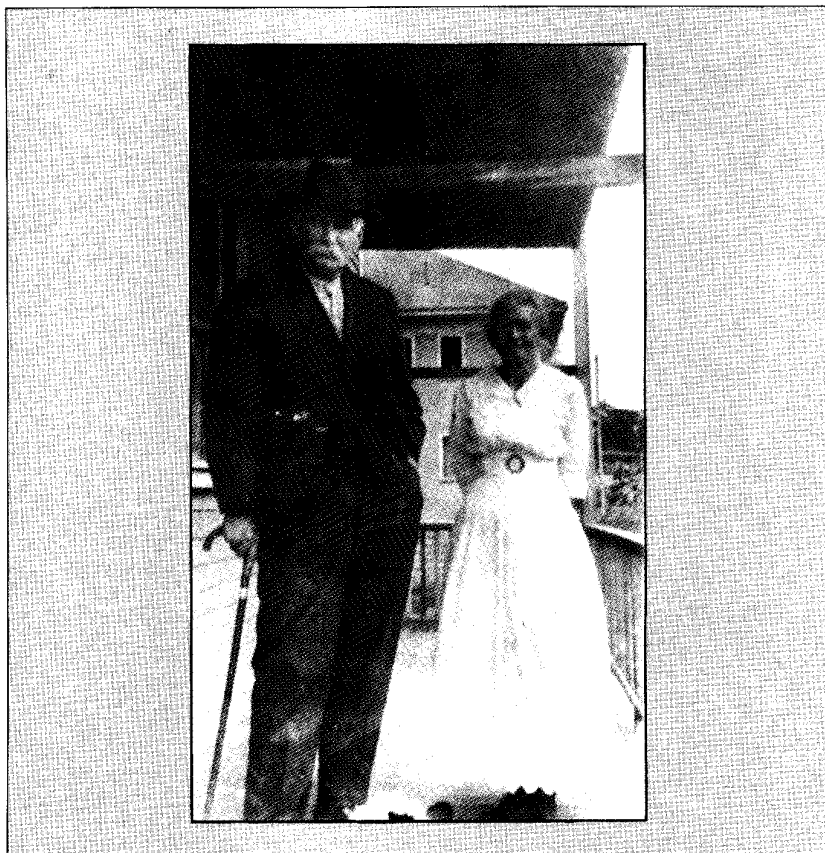

## THE GREAT COMMUNICATOR

Work anywhere on your lap-size computer, then transfer files directly to your desk-bound micro. Or use your lap-size as a go-between to move files from one brand of desk computer to another.

All you need is HardWire®, the menu-driven program that speeds files between lap-size and microcomputers. Use it with any combination of the NEC 8201/8401, Radio Shack Model 100/200, or Epson Geneva lap computers with the IBM-PC, PC-compatibles, or any Kaypro. Add a cable and go!

HardWire® program and easy-to-follow manual:

only **\$39.95**

Specify MS-DOS, or Kaypro CP/M  
Or get any two versions for just  
**\$59.95**

VISA and MasterCard accepted.  
To order or for information,  
call or write:

**POMERLEAU COMPUTING SYSTEMS** of Hyde Park  
P.O. Box 337585

Chicago, IL 60637 (312) 667-2075

Call us for information  
on other lap-size computers.

Circle 17 on Reader Service Card

There's really nothing that can go wrong. The menu gives you your choices, and if you're stuck you can always hit F8 to quit and start over. The F7 (Top) will take you back to the top of your outline.

The only problem I had was when I experimented with Expand and Compress and ended up with an extra sublevel where I didn't want it. To correct this mistake, I had to explore the Delete process. (Obviously, if you set up your family tree as I have, you would *never* want to explore the Kill process, or you'd lose the entire thing.)

To delete, first put the cursor over the item you want deleted. Then hit F4 (Del). The menu changes, giving you the choice of Quit or F1 to go ahead with the deletion. If you choose to delete a sublevel, you also delete any Notes and sublevels under that. This made me a little nervous because I had already gone ahead and continued with my tree after making this error, and had names below it that I wanted to keep. No problem. It deleted my mistake and reorganized itself, giving the spouse the correct number.

You may also move copy around or, if research turns up some new names,

add subideas into the middle of your outline. To do either of these maneuvers, you have to enter "Key Set 2," another whole level of commands including Move, Sort and Print copy. To get to Key Set 2, just hit F5 and you'll see a new set of choices accessed by F1-F8 (three will be the same: Exp/Cmp, Quit and Key Set).

### RESULTS, PLEASE

Printing out your family tree is as easy as any other function with Idea. The menu gives you choices: You may print any single Idea or the entire file, with or without Notes, and with or without numbers designating sublevels. Depending on your printer, you may first have to do some adjustments in BASIC to convert the program properly.

I chose to print out my tree with the designating numbers, but was disappointed to find that when printed, only the numbers 1. and 2. were used, instead of the more extended numbers shown earlier. This makes it difficult to tell which 1. goes with which 2. The problem is compounded by the fact that each level is indented only one



## FAMILY TREE



space. With Idea indentation cannot be changed, but if you want to fiddle with hanging indents you can use Ultimate Rom II's T-Word.

The fact that all your data is in one file is rather dangerous since you can accidentally mess up the entire file. I know because I did it; my system crashed and could not be restored, so I ended up retyping my tree. If you choose to set up your files as I have, you'd be well advised to back up your files frequently. But I still like the setup because you can use Idea for other applications as long as there's memory space left.

There are several handy features included in Idea that make genealogy research (or any other kind, for that matter) easier. One is the F6, or Find, feature. If you're in the library and you find a name that you think ties in to your tree but aren't sure where, hit F6 and provide a key name. Idea will locate the level for you quickly so you don't have to flip through screens by screen.

Another useful feature is the outline preview, which you can access any time you're not in the Edit mode simply by pressing the space bar.

Doing so will give you an overview of your outline, listing names only and not all the information stored in Notes. This preview outline can be scrolled up and down by pressing the arrow keys, so you can see how many levels you have accumulated under a name.

Since Idea automatically arranges itself in outline form, with each level given a designating number, the need for inventing your own code system is eliminated. Call up any name with the search function and you can tell just by looking at the number its approximate location in your tree.

The Ultimate ROM II version of Idea has a Fast Insert mode so you can quickly add a series of headings, then later go back and use Notes to add information about each name. This is useful when you're just beginning to convert your hobby from paper to computer.

Whether you're a newcomer to genealogy or a newcomer to Ultimate ROM II's Idea processor, remember this: Getting the information into the Model 100 is the easy part. How far back you want to research your roots is up to you. □

*Listing begins on page 40*

## METAB

Calculates metabolic rate,  
caloric intake  
and change in weight.  
**\$15.00**

## D SPELLER

A ".DO" file spelling checker  
from 100 word + dictionary  
stored on disk.  
**\$60.00**

## IQ TEST

A short form IQ test.  
**\$20.00**

## PSYCHI

A psychiatric evaluator.  
**\$40.00**

"Now available on the Tandy  
Portable 3 1/2" Drive"

## SOFTMATE INC.

P.O. Box 15157  
Portland, OR 97215  
(503) 230-1490

## 8K RAM \$25 MODULE

**F  
R  
E  
E**

- Ramtest software and
- Prop Legs with order
- Shipping

ULTRA LOW POWER  
Cmos design

Easy step by step  
installation instructions  
1 YEAR WARRANTY

MC VISA COD MO ship same day  
\$25 each or 3/\$70

WE SERVICE WHAT WE SELL.  
HOBBYIST SPECIAL: Kit form  
all parts except 6264LP \$16

ECONOMY COMPUTER CONCEPTS  
Box 2047, N. Babylon, NY 11703

Voice: 516 587 6947  
24 HR MODEM LINE: 669 4764  
300 Baud 7 Bit No Parity

# Take off with a Tandy® portable and have real computing power wherever you travel.

## Great traveling companions

Whether you're a businessperson, journalist, police officer or student, you can't afford idle time. Our affordable Model 100, Tandy 200, and Tandy 600 portable computers are invaluable tools that help keep you on top of your work wherever you go.

## Computing power for less

The popular Model 100 (26-3802) is perfect for writing letters, reports and other correspondence anywhere, at any time. Or use the 100 as your personal appointment calendar and name/address and phone directory. This lightweight computer was the first to feature five instant-on programs, as well as a 40 x 8 display—all built in.



At only \$499, this powerful little traveler offers you more options than you thought possible—including a built-in modem and a communications program that lets you access other computers or national information services by phone. You can even write your own programs in BASIC.

## Powerful portability

The \$799 Tandy 200 represents a true second generation in portable computers. Not only does it come with its own built-

in software, improved features, a bigger 40 x 16 floptop screen, and a larger memory, but it weighs only 4 1/2 pounds.

Plus, the Tandy 200 (26-3860) comes with powerful Multiplan® spreadsheet analysis built right into the memory. You can do complex spreadsheet calculations at the touch of a key. Answer thousands of "what if . . . ?" questions instantly.



## Our most advanced laptop

The high-performance Tandy 600 (26-3901) features a 16-bit microprocessor, an 80 x 16 display, a built-in 3 1/2" disk drive that stores 360K of data, and 32K RAM (expandable to 224K).

At \$1599, the Tandy 600 also includes five resident applications—all designed by Microsoft for anyone who's always on the go. With the Tandy 600's larger display and expanded memory, Multiplan can handle more information.

Using MS-Word®, you'll also have quicker access to documents and more storage capacity with the built-in disk drive. File is an electronic database for names and addresses, expenses, client billing and more. With the

Telecom program and the Tandy 600's built-in modem, you can keep in touch over phone lines.



## Don't leave the office without one

Tandy offers you a choice of three portable computers—one is sure to fit your needs. See them all at your local Radio Shack Computer Center!

Available at over 1200  
Radio Shack Computer Centers and at  
participating Radio Shack stores and dealers.

**Radio Shack®**  
**COMPUTER CENTERS**  
A DIVISION OF TANDY CORPORATION

## Send me an RSC-17 Computer Catalog.

Radio Shack, Dept. 87-A-28  
300 One Tandy Center  
Fort Worth, TX 76102

Name

Address

City

State

ZIP

Phone







# FAMILY TREE

*A sample outline family tree done on a Model 100 with Ultimate ROM II's Idea.*

- |   |   |
|---|---|
| <ol style="list-style-type: none"> <li>1. Andrew Seth Phillips<br/>Born 7-17-1901<br/>Died<br/>Married Louise Agnes Bertwell</li> <br/> <li>1. Ezra Andrew Phillips<br/>Born 6-24-1873<br/>Died 5-2-1924<br/>Married Luella Maude Morton</li> <br/> <li>1. Milo Phillips<br/>Born 4-5-1835<br/>Died 1-15-1883<br/>Married Lucy Blackmer             <ol style="list-style-type: none"> <li>1. Wilson Phillips<br/>Born 7-9-1806<br/>Died 9-11-1878<br/>Married Bertha Kellog                 <ol style="list-style-type: none"> <li>1. Solomon Phillips</li> <li>2. Susannah Wilson                     <ol style="list-style-type: none"> <li>1. Benjamin Wilson</li> <li>2. Mary Grimes</li> </ol> </li> </ol> </li> <li>2. Bertha Kellog<br/>Born 1814<br/>Died 6-12-1890<br/>Married Wilson Phillips                 <ol style="list-style-type: none"> <li>1. Jonathan Kellog<br/>Born<br/>Died 4-1-1827<br/>Married Betsy Brano</li> <li>2. Betsy Brano</li> </ol> </li> </ol> </li> <br/> <li>2. Lucy Blackmer<br/>Born 4-18-1842<br/>Died 10-28-1922<br/>Married Milo Phillips             <ol style="list-style-type: none"> <li>1. Abnera Blackmer</li> <li>2. Eunice R. Griffith</li> </ol> </li> <br/> <li>2. Luella Maude Morton<br/>Born 9-18-1878<br/>Died 1-25-1964             <ol style="list-style-type: none"> <li>1. Seth Peter Morton<br/>Born 8-12-1838<br/>Died 5-31-1924<br/>Married Matilda Jane Stickler</li> </ol> </li> <br/> <li>1. George Augustus Morton II<br/>Born 1802<br/>Died 1-3-1875<br/>Married Mary Siprell             <ol style="list-style-type: none"> <li>1. George Augustus Morton<br/>Born 6-7-1763<br/>Died 9-29-1839<br/>Married Agnes ?                 <ol style="list-style-type: none"> <li>1. Elkana Morton<br/>Born 1731<br/>Married Rebecca?                     <ol style="list-style-type: none"> <li>1. Elkanah Morton<br/>Born 10-1702                         <ol style="list-style-type: none"> <li>1. Ephram Morton<br/>Born 3-17-1671<br/>Married Hannah Faunce</li> </ol> </li> </ol> </li> </ol> </li> </ol> </li> </ol> | <ol style="list-style-type: none"> <li>2. Hannah Faunce<br/>Born 6-12-1678<br/>Died 1760<br/>Married Ephram Morton</li> <br/> <li>2. Mary Siprell<br/>Born 1806<br/>Died 10-9-1871<br/>Married George Augustus Morton II</li> <br/> <li>2. Matilda Jane Stickler<br/>Born 7-1-1838<br/>Died 10-12-1934<br/>Married Seth Peter Morton             <ol style="list-style-type: none"> <li>1. Martin Stickler</li> <li>2. Lucretia Griffin</li> </ol> </li> <br/> <li>2. Louise Agnes Bertwell<br/>Born 4-8-1900<br/>Died<br/>Married Andrew Seth Phillips</li> <br/> <li>1. Edward Francis Bertwell<br/>Born 6-22-1862<br/>Died 1-1-1933<br/>Married Agnes Louise James             <ol style="list-style-type: none"> <li>1. John Dickey Bertwell<br/>Born 8-31-1838<br/>Died 7-2-1863<br/>Married Mary Ann Friend                 <ol style="list-style-type: none"> <li>1. Robinson Bertwell<br/>Born ?<br/>Died 10-?-1891<br/>Married Hannah Dickey</li> <li>2. Hannah Dickey<br/>Born 1-18-1809<br/>Died 3-4-1840<br/>Married Robinson Dickey                     <ol style="list-style-type: none"> <li>1. John Dickey                         <ol style="list-style-type: none"> <li>1. Robert Dickey                             <ol style="list-style-type: none"> <li>1. Samuel Dickey</li> <li>2. Hannah Woodburn                                 <ol style="list-style-type: none"> <li>1. John Woodburn</li> </ol> </li> </ol> </li> <li>2. Margaret Woodburn</li> </ol> </li> </ol> </li> <li>2. Mary Ann Friend<br/>Born 7-14-1841<br/>Died 3-27-1904<br/>Married John Dickey Bertwell                     <ol style="list-style-type: none"> <li>1. Samuel Friend</li> <li>2. Catherine Cairns</li> </ol> </li> </ol> </li> </ol> </li> <br/> <li>2. Agnes Louise James<br/>Born 2-10-1867<br/>Died 2-21-1939<br/>Married Edward Francis Bertwell             <ol style="list-style-type: none"> <li>1. John William James<br/>Born 3-5-1841<br/>Died 5-25-1886<br/>Married Elizabeth Gail Andrews</li> <li>2. Elizabeth Gail Andrews<br/>Born 3-28-1840<br/>Died 4-14-1936<br/>Married John William James</li> </ol> </li> </ol> |
|---|---|



## READER SERVICE

Receive *more* information about products advertised in this month's PORTABLE 100 it's simple and free!

- Answer all questions on one of the postpaid reply cards.
- Circle the number(s) corresponding to advertisements for which you want more information.
- Either (a) print or type your name and complete address on the attached card and mail; or (b) telephone TOLL FREE **1-800-225-5800** 7 days a week, 8 am - 12 pm, Eastern time and give the operator your name and address. The operator will then ask you several of the questions, as well as in which Reader Service numbers you are interested.
- The literature you have requested will be mailed to you free of charge directly from the manufacturer.
- Allow 3 to 5 weeks delivery time for advertiser's material (1-3 weeks if you telephone 1-800-225-5800).

**IF YOUR NEED IS MORE IMMEDIATE, PLEASE CONTACT THE ADVERTISER DIRECTLY.**

# portable 100

# portable 100

# portable 100

NAME \_\_\_\_\_  
 COMPANY \_\_\_\_\_  
 ADDRESS \_\_\_\_\_  
 CITY \_\_\_\_\_ STATE \_\_\_\_\_ ZIP \_\_\_\_\_

**A. In which profession do you use your computer?**  
 1.  Education 2.  Journalism 3.  Law 4.  Medicine 5.  Business  
 6.  Other \_\_\_\_\_

**B. Do you use your computer to communicate with other computers?**  
 1.  Every day 2.  Once a week  
 3.  Not at all

**C. Which on-line service do you use?**  
 1.  CompuServe 2.  MCI 3.  NewsNet 4.  The Source 5.  Dow Jones 6.  Other \_\_\_\_\_

**D. How much do you use these services each week?**  
 1.  Less than one hour 2.  1-5 hours 3.  6-10 hours 4.  10+ hours

**E. Do you plan to purchase items based on an ad in this issue of Portable 100/200/600?**  
 1.  Yes 2.  No 3.  Don't Know

**F. What software/hardware will you purchase in the next six months?**  
 1.  word processing 2.  telecommunications 3.  financial planning  
 4.  printing 5.  memory expansion 6.  Other \_\_\_\_\_

1 2 3 4 5 6 7 8 9 10 11 12 13 14 15 16 17 18 19 20  
 21 22 23 24 25 26 27 28 29 30 31 32 33 34 35 36 37 38 39 40  
 41 42 43 44 45 46 47 48 49 50 51 52 53 54 55 56 57 58 59 60  
 61 62 63 64 65 66 67 68 69 70 71 72 73 74 75 76 77 78 79 80  
 81 82 83 84 85 86 87 88 89 90 91 92 93 94 95 96 97 98 99 100  
 101 102 103 104 105 106 107 108 109 110 111 112 113 114 115 116 117 118 119 120  
 121 122 123 124 125 126 127 128 129 130 131 132 133 134 135 136 137 138 139 140  
 141 142 143 144 145 146 147 148 149 150 151 152 153 154 155 156 157 158 159 160  
 161 162 163 164 165 166 167 168 169 170 171 172 173 174 175 176 177 178 179 180  
 181 182 183 184 185 186 187 188 189 190 191 192 193 194 195 196 197 198 199 200

NAME \_\_\_\_\_  
 COMPANY \_\_\_\_\_  
 ADDRESS \_\_\_\_\_  
 CITY \_\_\_\_\_ STATE \_\_\_\_\_ ZIP \_\_\_\_\_

**A. In which profession do you use your computer?**  
 1.  Education 2.  Journalism 3.  Law 4.  Medicine 5.  Business  
 6.  Other \_\_\_\_\_

**B. Do you use your computer to communicate with other computers?**  
 1.  Every day 2.  Once a week  
 3.  Not at all

**C. Which on-line service do you use?**  
 1.  CompuServe 2.  MCI 3.  NewsNet 4.  The Source 5.  Dow Jones 6.  Other \_\_\_\_\_

**D. How much do you use these services each week?**  
 1.  Less than one hour 2.  1-5 hours 3.  6-10 hours 4.  10+ hours

**E. Do you plan to purchase items based on an ad in this issue of Portable 100/200/600?**  
 1.  Yes 2.  No 3.  Don't Know

**F. What software/hardware will you purchase in the next six months?**  
 1.  word processing 2.  telecommunications 3.  financial planning  
 4.  printing 5.  memory expansion 6.  Other \_\_\_\_\_

1 2 3 4 5 6 7 8 9 10 11 12 13 14 15 16 17 18 19 20  
 21 22 23 24 25 26 27 28 29 30 31 32 33 34 35 36 37 38 39 40  
 41 42 43 44 45 46 47 48 49 50 51 52 53 54 55 56 57 58 59 60  
 61 62 63 64 65 66 67 68 69 70 71 72 73 74 75 76 77 78 79 80  
 81 82 83 84 85 86 87 88 89 90 91 92 93 94 95 96 97 98 99 100  
 101 102 103 104 105 106 107 108 109 110 111 112 113 114 115 116 117 118 119 120  
 121 122 123 124 125 126 127 128 129 130 131 132 133 134 135 136 137 138 139 140  
 141 142 143 144 145 146 147 148 149 150 151 152 153 154 155 156 157 158 159 160  
 161 162 163 164 165 166 167 168 169 170 171 172 173 174 175 176 177 178 179 180  
 181 182 183 184 185 186 187 188 189 190 191 192 193 194 195 196 197 198 199 200

NAME \_\_\_\_\_  
 COMPANY \_\_\_\_\_  
 ADDRESS \_\_\_\_\_  
 CITY \_\_\_\_\_ STATE \_\_\_\_\_ ZIP \_\_\_\_\_

**A. In which profession do you use your computer?**  
 1.  Education 2.  Journalism 3.  Law 4.  Medicine 5.  Business  
 6.  Other \_\_\_\_\_

**B. Do you use your computer to communicate with other computers?**  
 1.  Every day 2.  Once a week  
 3.  Not at all

**C. Which on-line service do you use?**  
 1.  CompuServe 2.  MCI 3.  NewsNet 4.  The Source 5.  Dow Jones 6.  Other \_\_\_\_\_

**D. How much do you use these services each week?**  
 1.  Less than one hour 2.  1-5 hours 3.  6-10 hours 4.  10+ hours

**E. Do you plan to purchase items based on an ad in this issue of Portable 100/200/600?**  
 1.  Yes 2.  No 3.  Don't Know

**F. What software/hardware will you purchase in the next six months?**  
 1.  word processing 2.  telecommunications 3.  financial planning  
 4.  printing 5.  memory expansion 6.  Other \_\_\_\_\_

1 2 3 4 5 6 7 8 9 10 11 12 13 14 15 16 17 18 19 20  
 21 22 23 24 25 26 27 28 29 30 31 32 33 34 35 36 37 38 39 40  
 41 42 43 44 45 46 47 48 49 50 51 52 53 54 55 56 57 58 59 60  
 61 62 63 64 65 66 67 68 69 70 71 72 73 74 75 76 77 78 79 80  
 81 82 83 84 85 86 87 88 89 90 91 92 93 94 95 96 97 98 99 100  
 101 102 103 104 105 106 107 108 109 110 111 112 113 114 115 116 117 118 119 120  
 121 122 123 124 125 126 127 128 129 130 131 132 133 134 135 136 137 138 139 140  
 141 142 143 144 145 146 147 148 149 150 151 152 153 154 155 156 157 158 159 160  
 161 162 163 164 165 166 167 168 169 170 171 172 173 174 175 176 177 178 179 180  
 181 182 183 184 185 186 187 188 189 190 191 192 193 194 195 196 197 198 199 200

# ad index

Reader Service Number	ADVERTISER	Page Number
1	A & J Micro Drive	42
5	A.R.M.S.	18
2	Acroatix, Incorporated	50
3	Acroatix, Incorporated	2
13	American Cryptronics	7
68	American Micro Supply	46
6	Axonix	55
43	Cabbage Cases	43
70	Canada Portable Computer	43
7	CISS	44
67	Delta	19
15	DFW Computer Center	53
23	Economy Computer Concepts	37
19	Elexor Associates	60
20	Fort Worth Computers	47
74	Hearthside Enterprises	60
21	Kangaroo Video Products	46
27	Merritt Computers	59
10	MinSof	20
29	Nictrix Corporation	36
31	Node Computer Systems	53
8	Omni Enterprises	63
—	PC Companion Magazine	25
37	P.C.S.G.	17
36	P.C.S.G.	45
32	P.C.S.G.	4
30	P.C.S.G.	21
41	P.C.S.G. CIV	
35	P.C.S.G.	49
34	P.C.S.G.	24
33	P.C.S.G.	11
69	Peptone Software	52
38	PG Design Electronics, Inc.	61
42	PIC	54
44	Polar Engineering	51
17	Pomerleau Computing	36
46	Purple Computing	33
54	Radio Shack	39
71	Sias Engineering	47
50	Sigea	CII
14	Simons Products	54
52	Softmate	37
12	Soundsight	19
62	Southworth Company	52
4	TechniGroup, Inc.	58
72	Traveling Software	CII
58	Traveling Software	1
9	ULTRASOFT	28
73	Unified Management	59

# YOU BE THE EDITOR

Every reader has unique needs. Some seek guidance from reviews of software and peripherals. Others look to a magazine to provide tips to increase their programming proficiency. Accounts of innovative applications attract a big audience, as do articles about other users who find creative ways to use their systems.

You can help tailor **Portable 100** to your unique needs by rating the articles that appeared in this issue. Just circle the numbers indicated below on the Reader Service Card at left. Rate all the articles, some of them or just one. Then detach the card and drop it into the mail — we pay the postage.

The editors will analyze your feedback and respond by commissioning more articles of the most popular types — and fewer of the losers.

### File Management

A Key to File Management (page 12)	
Excellent . . . . .	160
Good . . . . .	161
Poor . . . . .	162

### Expense Manager

Keeping Track (page 27)	
Excellent . . . . .	172
Good . . . . .	173
Poor . . . . .	174

### Reviews

The Bridge Over the River DOS (page 15)	
Excellent . . . . .	163
Good . . . . .	164
Poor . . . . .	165

### Power Light

The Power of Light (page 30)	
Excellent . . . . .	175
Good . . . . .	176
Poor . . . . .	177

### Reviews

Speed is the Gain (page 19)	
Excellent . . . . .	166
Good . . . . .	167
Poor . . . . .	168

### Family Tree

Laptop Genealogy (page 34)	
Excellent . . . . .	178
Good . . . . .	179
Poor . . . . .	180

### Spreadsheet

Calculating Your Costs (page 22)	
Excellent . . . . .	169
Good . . . . .	170
Poor . . . . .	171

### MAXRAM

What's Bell 103 Anyway (page 62)	
Excellent . . . . .	184
Good . . . . .	185
Poor . . . . .	186

### OVERALL QUALITY OF THIS ISSUE

Excellent . . . . .	187
Good . . . . .	188
Poor . . . . .	189

**LAPSTAR** 60 columns by 10 lines*"With Enhanced Features"*

The WORDSTAR\* like text processor that lets your M100 /NEC8201 display 55% more text on the screen than before. Plus gives you many more text entering and editing commands than TEXT. Includes the ability to type over all 60 columns. Free text formatter included.

Runs on  
the M-100  
and NEC 8201  
Version N

**CISS CORP** 3780 Manor House Drive, NE  
Marietta, GA 30062  
(404) 992-2200

only  
**\$74<sup>95</sup>**

\*WORDSTAR is a trademark of Micro-Pro Inc.

## NEW MASS STORAGE SYSTEM FOR ONLY \$89.95

### GREAT PERFORMANCE — INCREDIBLE PRICE

A&J Micro Drive would like to announce its new portable System 100. This mass storage system, designed for the Radio Shack Model 100, offers high speed storage for the price of a cassette.

The System 100, with electronics and software designed by A&J Micro Drive, uses the latest Micro Wafer Technology developed by Entrepo Inc. The new system combines high speed digital electronics with low cost, high performance Micro Drive Technology.

### INTERESTED . . .

The 100's compact operating system is smaller than that of the Radio Shack Disk Drive. The latest release of the operating system may be down loaded by calling the computer at A&J Micro Drive using the simple instructions included with the unit.

The System 100 may be small enough to fit into a corner of your briefcase and require only 4 "AA" -size batteries for months of use — but don't be fooled, our new unit is packed with state-of-the-art electronics. It will give you ultra reliable program loading as fast as the disk, and twenty times faster than the cassette.

The System 100 uses a miniature endless loop tape cartridge called a Micro Wafer. The Micro Wafer, approximately the size of a credit card, is completely enclosed in a protective housing. A built-in cover retracts as the tape is inserted into the drive, exposing the video-grade digital magnetic tape to the read/write head. Micro Wafers come in several lengths, allowing the customer to choose the length best suited to his application.

### STILL INTERESTED

The price of \$89.95 includes a drive system with cable attached, one Micro Wafer, operating instructions and one-year membership to the A&J Bulletin Board.

#### Manufacturer's Specifications

System 100  
**A&J Micro Drive**  
1050 E. Duane Ave. Ste "11"  
Sunnyvale, CA 94006  
(408) 732-9292

#### Price: \$89.95

Baud Rate: 14,000 bits/second  
Tape Speed: 10 inches/second  
Capacity: 1.5K bytes/foot tape  
10' = 15K bytes  
62' = 100 K bytes

Lengths: 10, 20, 35, 50, & 62'  
Power Supply: 4 "AA" cells  
Connection: Uses RS-232 port  
Cable: 30 inch RS-232 attached  
Size: 6 x 4 x 2.5 inches  
Weight: 24 ounces

**GIGO** (from page 9)

baud as he could certainly go higher.

He didn't mention the expense though. Radio Shack has a five foot cable for \$16.95 — but both ends are male. The PC XT's connector A is also male. Putting on the null modem adapter (one end male, the other female) for \$19.95 doesn't change the situation — a \$19.95 gender changer (female at both ends) is needed. Now we're up to \$60 and could be just as simply be looking at some third-party software. But I didn't mind putting the cabling together.

What stopped me (after I figured out which was my asynch port) is the CTTY doesn't seem to work. Fortunately someone reminded me that I have communications software on my XT. I set up CrossTalk to answer at 9600 bps and set STAT to 8 with no parity and XON disabled. Whoosh!

Now I have to put a CTRL-J at paragraph ends when I'm using the Model 100 as the XT doesn't recognize the 100's returns.

Still, thanks for the tip.

Jonathan Macy  
NYNEX Information Services

### CASSETTE QUESTIONS

I'm a satisfied subscriber to your magazine who owns a Tandy 200 and CCR-82 cassette recorder.

Do you know of BASIC program available that will list out all the files on a tape, and one that will search a tape for a specific file and load it?

I would also like to know of a book that defines more of the capabilities and applications that are applicable to my computer system.

Your assistance would be most appreciated.

David A. Williams  
Union Lake, MI

To answer the first part of your question, it's possible to create a list of all file names on a tape — but we don't have such a program. Perhaps one of our readers has one? As far as loading specific files from tape, the filename option of the CLOAD command provides that capability. You might also want to look into some of the commercially available cassette storage programs. Two that come to mind are Fast from MunSof, Box 1153, Minneapolis, MN 55440 (see review starting on page 19 of this issue) and T-Backup from Traveling Software, 11050 Fifth Avenue NE, Seattle, WA 98125, (800) 343-8080.

One book that Tandy 200 owners should not be without is The Tandy 200 Portable Computer by David A. Lien. It's available from Radio Shack (Cat. No. 26-3869).

—Ed.

**NEW PRODUCTS** (from page 10)

**Bubble Base**

New software has been introduced by SoundSight makers of the Bubble Memory system for the Model 100.

Bubble Database is a database manager that rivals desktop counterparts. It features a window format making it easy to use. It can handle several database files and features such utilities as indexing and sorting.

The software gives you random access capability allowing you to create a database file larger than available random access memory (RAM). And because of the bubble memory's non-volatile nature, there's little chance of losing data due to a cold start.

Bubble memories start at 128K and can be expanded to 512K. Prices vary. Contact SoundSight Bubble Memory Inc., 225 W. Broadway, Glendale, CA 91024 (818) 240-8400.

Circle No. 87

**See the Light**

If you have trouble reading the Model 100 or Tandy 200 screen, the Thin E/L from Axonix Corporation may be of interest to you. An electroluminescent panel that's inserted in your LCD, the Thin E/L works as a backlight, making your LCD clear and easy to read — especially in the dark.

A Thin E/L equipped Model 100 made the rounds here not long ago and we were suitably impressed.

Axonix promises to convert your portable in one week's time. Cost is \$200. Quantity discounts are available. Contact Axonix Corporation, 417 Wakara Way, Salt Lake City, UT 84108, (801) 582-9271.

Circle No. 85

**Kudos for Dr. DOS**

The Computer Press Association and Citizen America have honored *Sorry About the Explosion* by PC Companion columnist David D. Busch as 1985 Computer Book of the Year on the fiction category. Busch's biting satire about the computer industry received the award at ceremonies held during Comdex in Atlanta.

Text continues on page 55

3620 - 244 Street, Langley, B.C. V3A 4P6 Telephone 604-534-6441

Hardware, Software, Accessories

No more hassles with customs clearance

Write or phone for free price list

VISA - Master Charge

A service for Canadian users of:

TRS Model 100, Olivetti M10, NEC PC8201A

**Canada Portable Computer**

**MAKE YOUR ENTIRE SYSTEM... PORTABLE**

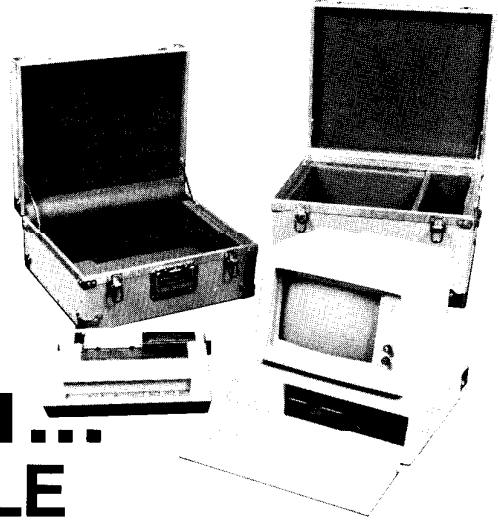

**Around Town . . . or Around the World**

Now, take your *entire* computer system with you anywhere you go . . . completely protected . . . in a custom-designed case by Cabbage.

So light-weight, you can carry it with you like a briefcase. So rugged, you can ship your computer . . . plus, any combination of peripherals . . . safely and easily across country or around the world by commercial transport.

**You Can Trust Cabbage Quality!**

Over the last decade Cabbage has become widely recognized as one of the foremost manufacturers of custom-designed electronic, scientific, and audio-visual equipment cases in the world. Cabbage experience, quality, and craftsmanship is unsurpassed and unchallenged. We use only the finest, most durable materials and hardware, throughout. Each Cabbage Case is a custom-made, personalized piece of equipment . . . designed to satisfy your specific problems and needs. It is even exclusively serial numbered for your convenience and protection. You get all the extras . . . at no extra cost.

If it must arrive in perfect condition . . . protect it in a Cabbage Case.

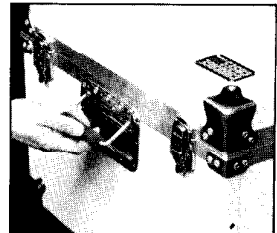

Heavy-duty, nickel-plated steel hardware

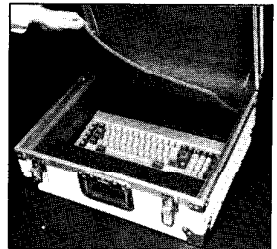

Durable, high density foam interiors

**CABBAGE CASES**

2458 Wood Avenue • Columbus, Ohio 43221  
(614) 486-2495

*"Nothing's Tougher . . . Than a Cabbage"*



## FILE MANAGEMENT (from page 14)

number has been entered you'll be prompted again; pressing ENTER will invoke the document backup mode.

Entering the backup mode will activate a "floating" block cursor that will appear adjacent to the first document file in the directory. The F1 soft key will be redesignated as the TOGL key. The TOGL key is used to toggle between selection and deselection of document files for tape backup. Selected files will be displayed in the reverse video format.

While in this mode, empty document files may not be selected for tape backup. These files are readily identified as they have no file extension.

Use the up or down cursor control keys to maneuver the cursor between document files. BASIC and machine language entries are skipped altogether. The floating block cursor and TOGL key are integrated system features that are also available in the tape upload and document delete modes. Pressing ESC will deselect all selected files and exit the backup mode. Pressing ENTER reformats the directory to display only those documents that were selected for tape backup. In addition, the date and time of backup are displayed, along with the total number of bytes used by all files in the directory and the tape ID number. A status line and directory are written to tape storage for eventual access by LOAD.

As documents are written to tape storage at the rate of 255 bytes per cycle, the number of bytes saved is incremented every cycle and the percentage of output calculated. This data is displayed as the last two entries of the directory, and provides you with a useful tracking system. This feature is also available when selected documents are restored from tape using LOAD. Once the tape backup is complete, press ESC to return to the main menu display.

When LOAD is selected (press ESC to cancel this procedure), run the tape counter to the setting that identifies the position where the desired directory has been saved. You'll recall that this position is indicated by the last three digits of the tape directory ID number. Press ENTER to execute a search for the tape directory. Should an input error be detected while attempting to restore a tape directory, a warning will sound with an appropriate error message. Pressing ESC will clear the error status and allow you to rewind the tape and try again.

When the tape directory is finally located, its ID number will be read from tape and displayed. Then the directory

```

:PR$="edit?" + SPACES(34)
:A=ASC(MID$(F$,9))
:IF A<68 THEN MID$(PR$,1)="run it?"
52 GOSUB 944
:GOSUB 922
:GOSUB 996
:CLS
:IF A=68 THEN F$=LEFT$(F$,6)+CHR$(13)
:FOR A=1 TO LEN(F$)
:POKE 65449+2*A,ASC(MID$(F$,A,1))
:POKE 65450+2*A,0
:NEXT
:POKE 65450,A-1
:CALL 24070 ELSE CALL NV
:IF A=66 THEN RUNF$ ELSE RUNMF$
100 KEYOFF
:IF NF=19 THEN PR$="directory is full!"
:GOTO 936 ELSE SW=1
:CALL NV
:GOSUB 914
102 CALL RV
:PRINT @LL,"open file:      .DO"+SPACES(20)
:FK=1
:GOSUB 948
:NAS=NAS+SPACES(9-LN)+"D"
:FOR X=1 TO NF
:IF F$(X)=NAS THEN ERROR 55 ELSE NEXT
:OPEN NAS FOR OUTPUT AS 1
:CLOSE
:F$(X)=NAS
:NF=X
:GOSUB 914
:SW=2
:IF X=19 THEN 950 ELSE 102 ELSE NEXT
:NEXT
200 GOSUB 934
:PR$="display it?" + SPACES(28)
:GOSUB 944
:GOSUB 922
:CALL NV
:PRINT @0,SPACES(140);SPACES(140)
:CALL RV
:PRINT LEFT$(F$(X),6)+" "
:A=SZ(X)
:AD=AD(X)
:SZ=A+AD
202 CALL 16949
:CLS
:CALL NV
:FOR B=AD TO SZ-1
:IF CSRLIN<6 THEN PRINT CHR$(PEEK(B));
:NEXT
:IF B=SZ THEN GOSUB 944
204 AD=B
:CALL 16954
:CALL RV
:PRINT @315,USING"###%";(A+B-SZ)*100/A
:GOSUB 928
:IF KY=13 AND B=SZ OR KY=27 THEN 30 ELSE IF
KY=13 THEN 202 ELSE 204
300 GOSUB 934
:CALL RV
:PRINT @LL,"string      :"+CHR$(34)+SPACES(27)
+CHR$(34)
:CU=290
:LN=27
:GOSUB 954
:TGS=IN$
:TG=LEN(TGS)
:IF TG=27 THEN SOUND534,4

```

# USE YOUR DESKTOP COMPUTER AS A DISK DRIVE FOR YOUR M-100.

*New!*  
IBM, MS-DOS  
version works  
over the phone!

# Disk+

on Snap-In™ ROM

NOW  
AVAILABLE  
ON  
M-200

## Try Disk+ for 30 days. If you aren't as excited as we are, return it for a full refund.

When we designed *Disk+* we did it out of necessity. We wanted a way that we could just connect a Model 100 to our desktop computer with a cable and save files onto the desktop's disk drive. We wanted it to be so simple to use it would be self-explanatory.

Picture this. *Disk+* comes to you on a Snap-in ROM and a diskette for your desktop. You take a quarter and open the little compartment on the back of your Model 100. Then you just press the ROM into the socket. *Disk+* appears on your main menu just like a built-in.

You connect your Model 100 to your other computer using an RS232 cable (available from PCSG for \$40).

You just place the *Disk+* diskette into the desktop's drive and turn on the computer. It powers up automatically and says "awaiting command" on your desktop's screen. Then you just put the widebar cursor on the Model 100 main menu on *Disk+* and press ENTER. You are shown your RAM files arranged just like the main menu.

To save a file to your other system's disk drive, you just move the widebar cursor to the file you want to save and press ENTER. It is saved instantly with no further action.

To look at the disk directory, you just press a function key on your Model 100. You see immediately the disk directory on your Model 100 screen, and it is arranged just like your Model 100's main menu.

To load a file from the diskette to your Model 100, you just move the widebar cursor to the file and press ENTER. The file is transferred to your Model 100's RAM instantly. You can press F8 and go back to the main menu, and the file you loaded from diskette is there, ready to use.

It is so nice to be able to keep your documents, programs (both BASIC and machine code) and *Lucid* spreadsheet files on the diskette, and bring them back when you need them. All files are ready to run or use with no changes or protocol by you.

**If you have access to a desktop computer and don't have *Disk+*, then evidently we have done a poor job telling you about it.**

All files and programs that you load or save, go over and come back exactly as they are supposed to be because of full error checking. This guaranteed integrity is really a comfort. *Disk+* is wonderful in so many other ways. For example, you can do a "save all" of all your RAM files with just a touch of a function key. That group of files is saved on the diskette under a single filename with a .SD (for subdirectory) extension. Any time you want, you can bring back all those files at once, or just one or two if you like, again with one-button ease.

*Disk+* takes up no RAM. That's zero bytes either for storing the program or for operating overhead.

What really excites most *Disk+* users is text file cross compatibility. Your Model 100's text files are usable on your desktop computer, and your desktop's text files become Model 100 text files.

This means you can write something on your Model 100, and with *Disk+* transfer it

instantly to your desktop and start using it right away on your bigger computer. Or the way we like to work is to type in a document on the desktop computer and then transfer it to our Model 100 with *Disk+*. Then we print out the document, beautifully formatted, using WRITE ROM.

*Disk+* works with just about every micro sold, from IBM PC and its clones, to all Radio Shack computers (yes, all), to Apple II, Kaypro, Epson and most CPM. Just ask us. More than likely, your computer is supported.

Incidentally, hundreds of Model 100 owners have gone to their Radio Shack stores and bought a color computer because it is so low priced, and with *Disk+* they have an inexpensive disk drive.

And if that weren't enough, how about this: *Disk+* also provides cross-compatibility between different computers like IBM, Apple or the Model 4 using the Model 100 as the intermediary device. Quite a feature!

The snap-in ROM is really great because you can use other ROMs like *Lucid* or WRITE ROM. They snap in and out as easily as an Atari game cartridge and you never lose your files in RAM.

Anyone who ever uses *Disk+* simply can't do without it. But so many times we have had new users call us and say, "Wow! I had no idea when I ordered it that *Disk+* would be so fantastic. I just couldn't believe that I could use my desktop computer's disk drive with my Model 100 just like it is another main menu."

That's why we sell *Disk+* on a thirty-day trial. If you aren't completely satisfied, return it within thirty days for a full refund. Priced at \$149.95 on Snap-in ROM. MasterCard, Visa or COD.

## PORTABLE COMPUTER SUPPORT GROUP

11035 Harry Hines Blvd., #207, Dallas, Texas 75229 • 1(214) 351-0564

PCSG provides hotline software support for the Model 100. Call us at 1-214-351-0564

© PCSG 1985

Circle 36 on Reader Service Card

## FILE MANAGEMENT

will be loaded and compared with the RAM directory to determine which files, if any, exist in both. If matches are found, they too will be compared to check for a difference in size (plus, minus or equal). An appropriate extension (+,-,=) will be appended to the filename to indicate that the tape file is greater than, less than or equal to a RAM file of the same name. Documents that appear only in the tape directory will retain the extension "D."

For example, if your tape and RAM directories contain the document named DOCMNT D and your tape version is smaller in size than its RAM counterpart, the file will appear in the restored tape directory as DOCMNT - to indicate that it is smaller. If the file was not found in RAM, it would appear in the tape directory as DOCMNT D.

The comparison of every file in both directories is a rapid procedure which, aside from a brief delay before the tape directory is actually displayed, is virtually transparent. Once completed, control will automatically default to the upload mode.

LOAD also features a unique memory management system that allows precise control over available RAM,

```

302 CALL NV
:PRINT @0, SPACES(140); SPACES(140)
:CALL 16949
:CALL RV
:PRINT
LEFT$(F$(X),6)+" .DO:" + SPACES(27-TG)+CHR$(34)+TG$
:CALL NV
:CALL 17472
:OPEN F$(X) FOR INPUT AS 1
:SZ=SZ(X)-1
:SV$=""
304 A=70
:IF A>SZ THEN A=SZ
306 SZ=SZ-A
:IF A>0 THEN SR$=INPUT$(A,1)
:SR$=SV$+SR$ ELSE 312
308 KEY(8)ON
:ONKEYGOSUB ,,,,,,30
:B=INSTR(SR$,TG$)
:IF B=0 THEN 314 ELSE KEYOFF
:PRINT LEFT$(SR$,B-1);
:CALL RV
:PRINT TG$;
:CALL NV
:SOUND11172,4
:SR$=MID$(SR$,B+TG)
:IF INSTR(SR$,TG$)+INSTR(TG$,RIGHT$(SR$,1))=0
THEN PRINT SR$;
:SR$=""
310 GOSUB 928
:IF KY=27 THEN 30 ELSE IF KY<>13 THEN 310 ELSE
IF B>0 THEN 308

```

## PORTABILITY

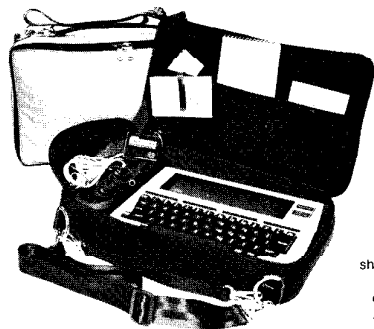

**\$59.95**

(Add \$2.50 shipping & handling per case in the continental U.S., Alaska & Hawaii add \$3.50)

## MADE COMPLETE

The **Chip-Tote™ PCD-1** makes your TRS-80 Model 100, 200 or comparably sized briefcase portable truly complete. It's the first light-weight soft case that doubles as a desk.

The **Chip-Tote™ PCD-1** is constructed of rugged Cordura® nylon and our special closed cell foam, so you can be sure your computer and its accessories will get the maximum in protection. So next time don't leave the office behind — carry it with you!

YES, send me: \_\_\_\_\_ PCD-1(s) in \_\_\_\_\_ Black \_\_\_\_\_ Smoke Grey

Name \_\_\_\_\_ Phone (\_\_\_\_) \_\_\_\_\_

Address \_\_\_\_\_

City \_\_\_\_\_ State \_\_\_\_\_ Zip \_\_\_\_\_

Signature \_\_\_\_\_

CHECK/MO (CA res. add 6% tax)  C.O.D. (Add \$1.65)

M/C  VISA \_\_\_\_\_ Exp. \_\_\_\_\_



KANGAROO VIDEO PRODUCTS, INC.  
10845 Wheatlands Ave., Suite "C" • Santee, CA 92071-2856 • (619) 562-9696  
ENGINEERED CASES FOR SENSITIVE ELECTRONIC EQUIPMENT

Circle 21 on Reader Service Card

## 8K EXPANSION RAM

TRS-80 model 100, NEC 8201

**\$24.<sup>95</sup>**

Set of three \$59.<sup>95</sup>

90 Day Warranty

Instruction Included

Easy Installation

Shipping Included on Prepaid

Orders • Shipped via U.P.S.

C.O.D.

WA Residents add 8.1% sales tax

## AMERICAN MICRO SUPPLY, INC.

1420 N.W. Gilman Blvd.

Suite 2333

Issaquah, WA 98207

(206) 391-3483

Circle 68 on Reader Service Card

## FILE MANAGEMENT

```

312 IF A>0 THEN 304 ELSE PRINT SV$
      :GOTO 30
314 C=LEN(SR$)
      :SV$=RIGHT$(SR$,TC)
      :IF C>TG THEN PRINT LEFT$(SR$,C-TG);
316 GOTO 312
400 KEYOFF
      :IF X=1 THEN 42 ELSE A$=F$(X)
      :B$=MID$(A$,7)
      :C$="BACODO"
      :C$=MID$(C$,INSTR(C$,MID$(A$,9)),2)
      :CALL RV
      :PRINT @LL,"change to:      .":C$+SPACE$(20)
402 FK=4
      :GOSUB 948
      :NA$=NA$+SPACE$(7-LN)
      :FOR A=2 TO NF
      :IF F$(A)=NA$ THEN ERROR 55 ELSE NEXT
      :NAMELEFT$(A$,6)+C$ASNA$+C$
      :F$(X)=NA$+B$
      :GOSUB 914
      :SW-2
      :GOTO 400
500 KEYOFF
      :T$=LEFT$(TIME$,5)
      :CALL RV
      :PRINT @230,"time:"+LEFT$(TIME$,2)+MID$(T$,4)
502 IF INSTR(TIME$,T$)=0 THEN 500 ELSE KY$=INKEY$
      :IF KY$="" THEN 502 ELSE GOSUB 930
      :IF KY=27 THEN CALL NV
      :PRINT @230,SPACE$(9)
      :GOTO 940 ELSE 502

```

and a feature that displays the number of documents that would exist in memory should selected documents be loaded. At the heart of this system is the enigmatic "beginning memory."

You'll recall that the beginning memory is a constant value that is determined during initialization or when new RAM files are opened, current RAM files are deleted or tape files are loaded. The beginning memory is an important tool, because it represents the total amount of free memory available for restoring files and remaining operational. Should memory be exhausted, the screen will clear, an error message will be displayed, free memory will be reset and control will default to the main menu display. However, should available memory be so low that practical operation is no longer possible, control will default to the Model 100 menu. You should interpret the latter condition as notice that files must be saved or deleted before normal operation may resume.

When you press TOGL to select or deselect files for possible upload, the available memory increases, decreases or remains unchanged consistent with the extension appended to the file-

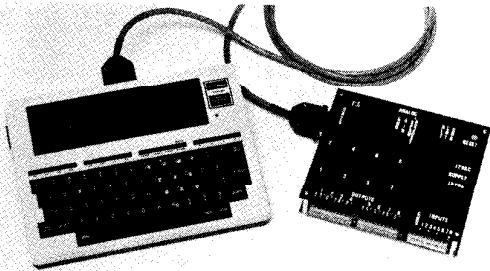

## REAL WORLD CONTROL

Use the CIP/35A and your MODEL 100/200 for control of home, office, business, security, environment, classroom lab, process control and data acquisition. Plugs into serial port and is easily controlled from BASIC or TELCOM. The CIP/35A is the most cost effective input/output board on the market today and the easiest to use!

### SPECIFICATIONS:

- 8 RELAY OUTPUTS, HIGH CURRENT
- 8 INPUTS, GROUND FOR OPERATION
- 1 - 8 BIT A/D WITH PROVISIONS FOR UP TO 8
- 1 - 8 BIT COUNTER INPUT
- AC OR DC POWER SUPPLY
- SOFTWARE EXAMPLES PROVIDED
- INDUSTRIAL QUALITY
- SHIPPED WITHIN 48 HOURS
- 6 MONTH WARRANTY ON ALL PARTS

**\$199.95**

**SIAS** Engineering, Inc.

RURAL ROUTE 1, SALINA, KANSAS 67401 / (913) 823-8027

Circle 71 on Reader Service Card

PORTABLE 100 AUGUST 1986

# TRS-80™

SAVE SALES TAX \*PLUS DISCOUNT  
\*TEXAS RESIDENTS ADD ONLY 4.16%

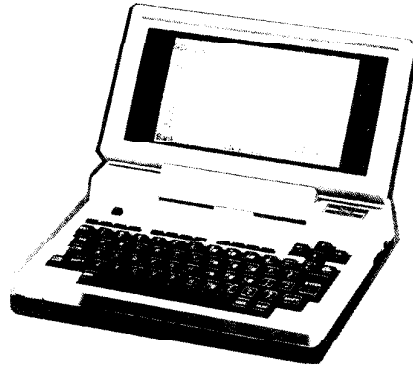

TANDY 200-72K

## FORT WORTH COMPUTERS

WE ARE SERIOUS ABOUT SAVING YOU MONEY

(Located 30 miles from Fort Worth)

377 PLAZA • GRANBURY • NR FORT WORTH, TEXAS 76048

**CALL FREE: 1-800-433-S-A-V-E**

Monday thru Friday - 9:00 a.m. to 5:00 p.m.

(Order inquiries/Customer Service &) IN TEXAS: 817-573-4111

Circle 20 on Reader Service Card



## FILE MANAGEMENT

name. For example, selecting a filename with the extension "-" will cause the memory value to increase since the size of the selected tape file is smaller than its RAM counterpart. Selection of a filename with the extension "+" or "D" always results in a memory debit.

Because of an incorporated system block, the value of available memory will not be permitted to drop below 1,171 bytes. For example, if this value is down to 1,500 bytes and you attempt to select a document of 500 bytes, selection of the document would be blocked. The purpose of this is to maintain an overhead of at least 1,000 free bytes for program operation.

Note that the number of documents that would exist in RAM increases when the selected document exists in the tape directory only (as indicated by the extension "D"). This is logical, as tape and RAM files of the same name are assumed to be the same document and their selection should not be seen as an increase in resident documents. Should the number of documents that would exist in RAM reach 19, further document selection will be disabled (unless the document name already exists in RAM).

Note too that BASIC and ML documents are not included in this number, so if your directory contains 16 files and two of these are program files, the total number of displayed documents would be 14. In this case, you could only select another three documents for restoration from tape storage.

Once you've selected the documents you wish to restore, pressing ENTER reformats the directory to display only those documents. The subsequent process of restoring selected documents to RAM is identical to the tape backup function (another KEYS integrated feature). Following restoration of selected document files, control will default to the main menu display.

F7 - KILL: Pressing KILL invokes the delete mode and allows you to remove selected document files. Use the up or down cursor control keys to maneuver the floating block cursor between files. Press TOGL to alternately select or deselect files for deletion. Selected files will be displayed in the reverse video format. ESC deselects all selected files and exits the mode. Press ENTER twice to kill selected files.

F8 - QUIT: Pressing QUIT resets the soft keys to their default values, sets the maximum number of files (MAX-FILES) to null and exits to the Model 100 menu display.

And that's all there is to it. □

```

600 KEYOFF
:GOSUB 914
602 PRINT @LL,"SAVE LOAD"+SPACES(30)
604 KEY(1)ON
:KEY(2)ON
:ONKEYGOSUB 610,650
:GOSUB 928
:KEYOFF
:IF KY=27 THEN GOSUB 914
:GOTO 938 ELSE 604
610 KEYOFF
:FK=6
:IF DO=0 THEN GOSUB 934
:GOTO 602 ELSE FOR A=2 TO NF
:IF SZ(A)=1 THEN NEXT
:PKS="no data on file!"
:GOSUB 936
:GOTO 602 ELSE PRINT @LL,
"open tape:      .DO"+SPACES(22)
:CU=289
:LN=6
:GOSUB 954
:IF KY=27 THEN 602
612 FOR A=2 TO 6
:IF INSTR("AB",LEFT$(NAS,1))=0 OR
INSTR("0123456789",MID$(NAS,A,1))=0 OR LN<7 THEN BEEP
:GOTO 610 ELSE NEXT
:PRINT @289," "+NAS+"? "
:GOSUB 944
614 GOSUB 928
:IF KY=27 THEN 610 ELSE IF KY>13 THEN 614 ELSE
MD$="backup"
:SV$=DR$
:MD=1
:FOR A=2 TO NF
:IF SZ(A)=1 THEN MID$(SV$,RC(A)-31)=" "
616 NEXT
:CALL NV
:PRINT @30,NAS+".DO",SV$
:SV$=""
:GOSUB 1000
:IF KY=27 THEN CALL NV
:PRINT @30,MID$(SL$,31)
:CALL RV
:GOTO 610
618 FOR X=2 TO NF
:SZ(X)-SZ(X)-1
:NEXT
:GOSUB 970
:SL$="dy:"+MID$(DATE$,7)+LEFT$(DATE$,2)+MID$(
DATE$,4,2)+CHR$(245)+"time:"+LEFT$(TIME$,2)+
MID$(TIME$,4,2)+CHR$(245)+"usd:"+RIGHT$(SPACES
(3)+STR$(DA),5)+CHR$(245)+NAS+".DO "
620 GOSUB 976
:PRINT @LL,SPACES(4)
:MOTOR ON
:FOR B=1 TO 2000
:NEXT
:OPEN "CAS:" FOR OUTPUT AS 1
:PRINT #1,NAS+".DO"
:PRINT #1,SL$
:PRINT #1,DR$
:PRINT #1,A,DA
:FOR X=1 TO A
:PRINT #1,F$(X)
:PRINT #1,SZ(X)
:NEXT
:CLOSE
622 B=0

```

*Listing continues on page 50*

**Changes your Model 100 into a totally different computer with capability you never thought possible.**

**Lucid™**  
on Snap-In™ ROM

Infoworld  
rated Lucid's  
performance  
"excellent"

## PCSG says "Satisfaction Guaranteed or your money back within 30 days!"

LUCID® is here now. It is on a ROM cartridge that snaps into the compartment on the back of your Model 100. It takes no memory to load and no memory for operating overhead. That means you have the full 29.6k bytes free to store your data.

First, LUCID® is memory conserving. It will let you build a large spreadsheet—255 row by 126 column capacity. You build huge spreadsheets in your Model 100's RAM that could consume 80 to 100K on a desktop computer.

Secondly, LUCID® is fast. LUCID® is so rapid, a 36 column corporate financial statement took less than 4 seconds to calculate.

Thirdly, LUCID® has features you won't find in most other spreadsheets. For example, when you type a label (text) it will cross column boundaries; in other words when you type a label or title it will appear as you type it irrespective of column or width. LUCID® also allows you to set column widths individually, and of course LUCID® has insert row and insert columns, as well as other standard features. LUCID® even lets your formulas refer to cells in other spreadsheet files.

Further, LUCID® has what no other spreadsheet has: Cut, Copy, and Paste. It uses the same keys as Cut and Paste in TEXT, but here's the difference: it takes all the formulas with it when you paste and they all automatically recalculate with the entire sheet.

And here is what is really amazing. You can copy or cut from one spreadsheet and paste into another spreadsheet or even a TEXT file.

LUCID® supports all BASIC math functions as well as Log, sine, cosine, tangent, exponentiation and other sophisticated math functions.

LUCID® has so many features that you will say "this is what I need in a spreadsheet", such as automatic prompting of an incorrectly typed-in formula showing just where the mistake was made.

LUCID® has expanded "go to" functions that remember and produce a windowing capability.

But perhaps most remarkable is that LUCID® is not only a spreadsheet but a program generator as well. First, LUCID® lets you protect all cells against entry or change, and then unprotect just the cells you want for someone else to use as input fields.

LUCID® will not only process values, but text input as well so that the facts other than numbers can be responded to. LUCID® has the ability for you to refer in a formula to cells containing words. This feature combines with the capacity of doing "if then" statements that work by doing table look-ups against even massive X/Y charts of text or numerical information. You can produce a program that responds to inputs with no programming knowledge whatsoever.

You can prepare a report section in your spreadsheet with instructions to your user for printout, and they can produce a personalized printout that responds to their input. All your formulas and tables that did the calculations and provided the facts are invisible to that user. LUCID® is useful for doctors for patient questionnaires, troubleshooting technicians, purchase clerks, people doing job quotes, stores for customer workups, insurance agents and anybody who needs to process specific facts and numbers to produce a report based on those responses.

LUCID® comes with a manual that explains not only the characteristics of LUCID®, but will train you how to use a spreadsheet even if you have never seen one before. You are shown how to do budgets, forecasts, breakeven analysis amortizations and many other types of personal and business reports and calculations.

User friendly is such an over-used term in this industry, but a typical comment has been "I have never seen a spreadsheet that does so much, and yet LUCID® is so much

easier and faster to use."

LUCID® is a result of a most exhaustive developmental effort in which PCSG's objective was to develop a spreadsheet that was better than the state-of-the-art. We are so pleased because LUCID® provides for the Model 100 spreadsheet capability you cannot equal on a desktop computer.

LUCID® is, in our opinion and that of those who have examined it, a breakthrough. We sell it on a 30 day trial. If you are not completely satisfied, return it within 30 days for a full refund. Priced at \$99. on snap-in ROM. MasterCard, Visa or COD.

© PCSG 1984

First with  
software for  
the Model 100

PORTABLE  
COMPUTER  
SUPPORT  
GROUP

**1-214-351-0564**

11035 Harry Hines Blvd., #207  
Dallas, Texas 75229

## Don't Be Fooled!

As the saying goes, "you get what you pay for." True, but don't be fooled. A higher price tag doesn't make a product better—only more expensive.

POWR-DISK is the least expensive portable-disk-drive DOS available for the Model 100 or Tandy 200. What do you get for \$39.95?

- The smallest program on the market. POWR-DISK gives you complete access to the disk from BASIC using only 2.1K (2.2K for the Tandy 200).
- The only relocatable DOS on the market. Other packages (except our own POWR-DOS) require you to "turn off" the DOS before running most other machine-language programs. POWR-DISK can be run side-by-side with most other software.
- The only BASIC menu package on the market. Other packages (except POWR-DOS) have menu programs in machine language, which cannot be modified or customized easily. Ours can.
- The most liberal upgrade policy on the market. Our customers can apply every penny of POWR-DISK price toward POWR-DOS (except shipping costs).
- Our whole-hearted support. We've sent newsletters to our customers about common problems, enhancements, etc.

If you want more functionality, see our advertisement for POWR-DOS. It's the best DOS on the market for any price. But if you just want a good value on a solid, basic DOS, you can't do any better than POWR-DISK.

### **POWR-DISK** by Acro•atix

\$39.95 + \$3.00 Shipping

Acro•atix Incorporated  
P.O. Box 273  
Wilmington, MA 01887  
(617) 658-5550

Toll-free Order Line:

**1-800-225-5800**

## FILE MANAGEMENT (from page 48)

```

:FOR X=1 TO A
:GOSUB 914
:SZ=SZ(X)
:OPEN F$(X) FOR INPUT AS 1
:OPEN "CAS:"+F$(X) FOR OUTPUT AS 2
:GOSUB 980
:NEXT
:PR$="ESC to menu!"+SPACE$(27)
:IF M2<1171 THEN A=NF-A ELSE A=1
624 MOTOR ON
:FOR X=1 TO 1335*A
:NEXT
:MOTOR OFF
:GOSUB 944
626 GOSUB 924
:IF KY=27 THEN GOSUB 918
:GOTO 8 ELSE 626
650 KEYOFF
:IF DO=0 AND NF=19 THEN PR$="kill a file!"
:FK=6
:GOSUB 936
:GOTO 602 ELSE PR$="load tape directory?"
:GOSUB 944
652 GOSUB 928
:IF KY=27 THEN 602 ELSE IF KY<>13 THEN 652 ELSE
A=NF
:B=0
:IF DO=0 THEN B=A-DO+1
654 PRINT "searching ..."+SPACE$(6)
:OPEN "CAS:" FOR INPUT AS 1
:INPUT#1,NA$
:IF LEN(NA$)<>9 THEN ERROR 18 ELSE PRINT
SPACE$(30)+NA$
:INPUT#1,SL$,DR$,NF,DA
:MD$="upload"
:C=1
:DO=1
:MD=3
:FOR X=2 TO A
:D=INSTR(DR$,F$(X))
:IF D>0 THEN AD(C)=SZ(X)
:C=C+1
:MID$(DR$,D+0)="-"
656 NEXT
:C=1
:FOR X=1 TO NF
:INPUT#1,F$,SZ
:IF INSTR(DR$,F$)=0 THEN D=AD(C)
:AD(C)=SZ
:SZ=SZ-D
:C=C+1
:GOSUB 986
658 MID$(DR$,INSTR(DR$,LEFT$(F$,6)))=F$
:F$(X)=F$
:SZ(X)=SZ+1
:NEXT
:CLOSE
:GOSUB 944
:CALL NV
:PRINT @0,SL$,DR$
:PRINT @190,USING"bgn:"+U$;M2
:PRINT @230,USING"doc:"+U$;B
:GOSUB 1000
660 IF KY=27 THEN GOSUB 918
:GOTO 8 ELSE B=1
:FOR X=1 TO NF
:IF MID$(F$(X),9,1)="D" THEN SZ(X)=SZ(X)-1 ELSE
SZ(X)=AD(B)
:B=B+1
662 NEXT

```



## FILE MANAGEMENT

```
:IF A>NF THEN NF=A
664 GOSUB 970
:MID$(S$,25)=RIGHT$(SPACES(3)+STR$(DA),5)
:GOSUB 976
:CALL RV
:PRINT @LL,SPACES(4)
668 B=0
:FOR X=1 TO A
:SZ=SZ(X)
:GOSUB 914
:OPEN "CAS:"+F$(X) FOR INPUT AS 1
:OPEN F$(X) FOR OUTPUT AS 2
:GOSUB 980
:NEXT
:GOSUB 944
:GOSUB 918
:coto 8
670 CALL RV
:PRINT @LL,"input error!" + SPACES(28)
672 BEEP
:KY$=INKEY$
:IF KY$="" THEN 672 ELSE KY=ASC(KY$)
:IF KY=27 THEN GOSUB 918
:GOTO 8 ELSE 672
700 KEYOFF
:IF DO=0 THEN 934 ELSE MD$="delete"
:MD=2
:CALL NV
:GOSUB 914
702 GOSUB 1000
:IF KY=27 THEN GOSUB 914
:GOTO 938 ELSE PR$="kill!" + SPACES(34)
:GOSUB 944
704 GOSUB 928
:IF KY=27 THEN SW=1
:GOTO 702 ELSE IF KY<>13 THEN 704 ELSE CALL RV
:GOSUB 918
:FOR X=2 TO NF
:IF LEN(F$(X))>9 THEN KILLEFT$(F$(X),6)+"DO
706 NEXT
:GOTO 8
800 KEYOFF
:PR$="quit?" + SPACES(34)
:GOSUB 944
802 GOSUB 924
:IF KY=13 THEN PRINT @LL,"bye! "
:GOSUB 996
:MAXFILES=0
:MENU ELSE IF KY=27 THEN 938 ELSE 802
900 A=1
:B=INT(B/2)
:IF B=0 THEN RETURN
902 C=A
904 D=B+C
:IF SO=1 THEN IF AD(C)>AD(D) THEN 908 ELSE 910
906 IF MID$(F$(C),9)+LEFT$(F$(C),6)<=MID$(F$(D),9)+
LEFT$(F$(D),6) THEN 910
908 F$=F$(C)
:F$(C)=F$(D)
:F$(D)=F$
:E=AD(C)
:AD(C)=AD(D)
:AD(D)=E
:E=SZ(C)
:SZ(C)=SZ(D)
:SZ(D)=E
:C=C-B
:IF C>0 THEN 904
910 A=A+1
:IF A>NF-B THEN 900 ELSE 902
```

We are THE Experts!  
M100/T200/NEC

## Polar

is still the only place for your  
programming problems!

Anyone who does REAL work  
on the M100/T200/NEC uses...

**Cleuseau + ROM2**  
on plug-in ROM

"...the most under-rated product  
on the market..."

"I can't program without it."

"A Cadillac at a VW price!"

"...definitely not a toy..."

- Macro Assembler
- Machine Code Debugger
- BASIC Debugger
- BASIC Enhancements
- Text Enhancements
- BASIC Utilities

Still only.....\$95.00

Please add \$4 shipping and handling.

MasterCard/VISA

The only REAL security  
for your software...  
installed in a ROM.

Your programs cannot be:

viewed	copied
deleted	printed
lost	altered
transmitted	

Ask us about **Guardian**,  
our process to put YOUR  
BASIC programs in a ROM.

SAVES 90% of your memory.  
Your programs in a ROM  
can DOUBLE the capabilities  
of your Model 100. Tandy  
200 or Nec 8201A.

For information and to order,  
call or write:

**Polar Engineering and  
Consulting**

P.O. Box 7188  
Nikiski, Alaska 99635  
(907) 776-5529

After 9 am Alaskan, 10 am Pacific  
or 1 pm Eastern Time.

Circle 44 on Reader Service Card

# FILE MANAGEMENT

```

914 PRINT @RC(X),FS(X)
:CALL RV
:RETURN
918 PRINT @LL,"busy ...."+SPACE$(31)
:RETURN
922 GOSUB 924
:IF KY=13 THEN RETURN ELSE IF KY=27 THEN 938
ELSE 922
924 KY$=INKEY$
:GOSUB 926
:IF KY$="" THEN 924 ELSE 930
926 ONKEYGOSUB 100,200,300,400,500,600,700,800
:RETURN
928 KY$=INKEY$
:IF KY$="" THEN 928
930 KY=ASC(KY$)
:RETURN
934 KEYOFF
:IF DO=0 THEN PR$="no documents!" ELSE IF
MID$(F$(X),9)<"D" THEN PR$="not a document!"
ELSE IF SZ(X)=1 THEN PR$="file is empty!" ELSE
RETURN
936 BEEP
:CALL RV
:PRINT @LL,PR$+SPACE$(39-LEN(PR$))
:FOR A=1 TO 600
:NEXT
:PR$=""
:IF FK>0 THEN FK=0
:RETURN
938 M1=M2
:SW=0
:PRINT @LL,LB$
:IF M2<1171 THEN PRINT @34,USING$;M2
940 KEYON
:GOSUB 926
:CALL 23161
:GOTO 42
944 CALL RV
:PRINT @LL,PR$
:FOR C=1 TO 2
:SOUND622,2
:FOR H=1 TO 10
:NEXT
:NEXT
:PR$=""
:RETURN
948 CALL RV
:CU=289
:LN=6
:GOSUB 954
:IF KY>27 THEN RETURN
950 IF SW=1 THEN GOSUB 914
:GOTO 938 ELSE IF SW=2 AND INSTR(DR$,F$(X))=0
THEN GOSUB 918
:GOTO 8 ELSE 938
954 IN$=""
:FOR CH=1 TO LN
:GOSUB 956
:IF KY=27 THEN IF FK>0 THEN FK=0
:RETURN ELSE 938 ELSE IF IN$="" THEN 954 ELSE IF
KY>13 AND CH<LN THEN NEXT ELSE GOSUB 962
:RETURN
956 PRINT @CH+CU," "

```

## THIS HARD COVER

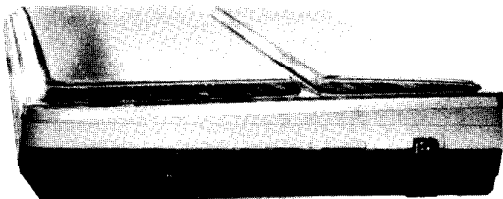

- Prevents broken keys & scratched screen
- Blocks dust, spills & things that get dropped
- Protects your 100 from other items in a briefcase
- Is made of unbreakable Eastman PETG clear plastic
- And, it creates the ultimate lap machine

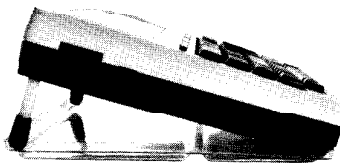

- Only \$22.95
- Includes Air Mail
- Immediate shipment

100%, 30 day money back satisfaction guarantee  
Chk. or M.O. TX res. add 5% Prop Legs not included

THE SOUTHWORTH CO. 4001 HAWTHORNE AVE. DALLAS, TX 75219

Circle 62 on Reader Service Card

## SPRINT.CO

Turn out professional quality correspondence  
with your Radio Shack MODEL 100 & 200 computer.  
For Under \$20.00 !

This program is used all over the world by the editorial  
staff of a major national publication.

Text formatting features include

- Variable Line Width
- Variable Line Spacing
- Word Wrap
- Auto Page Advance
- Change Printout Format via Menu AND/OR "In Text" Formatting Commands
- Hanging Indent
- Direct Enter Printer Escape Codes
- Flush Left or Right
- Fully Customizable
- Runs virtually any parallel or serial printer up to 19.2 K Baud!
- Machine language program requires only 1.8 K RAM

Performs the functions of other programs costing over  
twice as much! If not satisfied, return within 30 days  
for a complete refund of your money.

## SUPER CALCULATOR

Turns your MODEL 100 & 200 into a scientific  
printing calculator!

- Basic Math Functions
- Exponential Notation
- Square Roots
- Reciprocals
- Trigonometric functions
- Three Accumulator Registers

• Results on LCD-and/or stored in text-and/or printed on printer  
TO ORDER send check or money order for \$19.95 for SPRINT or  
\$14.95 for SUPER CALCULATOR plus \$1.50 shipping and handling  
to PEPTONE Software. SAVE \$5 by ordering BOTH for only \$29.90!

Specify if cassette or disc. Add \$5 for disc version

PEPTONE Software  
10112 Ebenshire Ct.  
Oakton, VA. 22124

Circle 69 on Reader Service Card

# FILE MANAGEMENT

```

:PRINT @CH+CU,;
:SV$=INPUT$(1)
:KY=ASC(SV$)
:IF KY>31 THEN PRINT SV$
:IN$=IN$+SV$
:RETURN ELSE IF KY=13 OR KY=27 THEN RETURN ELSE
IF KY=8 AND CH>1 THEN CH=CH-1
:IN$=LEFT$(IN$,CH-1)
:PRINT @CH+CU," "
958 GOTO 956
962 NA$=""
:FOR LN=1 TO LEN(IN$)
:A=ASC(MID$(IN$,LN,1))
:IF A>96 AND A<123 THEN A=A-32 ELSE IF A=46 THEN
A=0
964 NA$=NA$+CHR$(A)
:NEXT
:RETURN
970 A=0
:B=1
:DA=0
:FOR X=1 TO NF
:F$=F$(X)
:F$(X)=STRING$(9,58)
:IF LEN(F$)>9 THEN F$(B)=LEFT$(F$,8)+"D"
:SZ(B)=SZ(X)
:DA=DA+SZ(B)
:A=A+1
:B=B+1
972 NEXT
:F$(19)=SPACE$(9)
:FOR X=1 TO 19
:MID$(DR$,RC(X)-39)=F$(X)
:NEXT
:RETURN
976 CALL NV
:PRINT @0,SL$,DR$
:PRINT @190,SPACE$(9)
:CALL RV
:RETURN
980 C=255
:IF C>SZ THEN C=SZ
982 B=B+C
:PRINT #2,INPUT$(C,1);
:CALL NV
:PRINT @190,USING"by:"+U$;B
:PRINT @230,USING"pct:###.##";B*100/DA
:IF B=DA THEN CLOSE
:RETURN ELSE SZ=SZ-C
:IF SZ=0 THEN CLOSE
:GOSUB 914
:RETURN ELSE 980
986 IF SZ+1<0 THEN SV$="-" ELSE IF SZ+1>0 THEN
SV$="+" ELSE SV$=""
988 MID$(F$,9)-SV$
:RETURN
992 IF MD=3 THEN RETURN ELSE CALL 23161
:FOR X=2 TO NF
:F$(X)=LEFT$(F$(X),9)
:NEXT
:CALL NV
:PRINT @40,DR$
:MD=0
:X=0

```

**8K MODULE FOR TANDY MODEL 100,  
NEC 8201A AND M-10** Qty 3 at \$18

THOUSANDS SOLD, EASY INSTALLATION, GUARANTEED  
BEST ADVERTISED PRICE AND HIGHEST QUALITY

**24K MODULE FOR MODEL 200 \$59**

## DATAPAC® RAM CARTRIDGES

WITH 2 YEAR, USER REPLACEABLE BACKUP BATTERY

**256K (STARLET ONLY) \$329**

**128K (STARLET ONLY) \$169**

**32K (NEC 8201 ONLY) \$ 79**

**CALL (916) 265-4668**



### NODE POLICY:

- 30 day money-back guarantee
- 12 month warranty
- Quantity discounts start at 3
- Free UPS 2ND DAY AIR (Continental US) Hawaii add \$3
- Foreign add \$9 drive/\$3 other products

PAYMENT: VISA OR MASTERCARD. Checks held 14 days. C.O.D. add \$2. California residents add appropriate tax.

**NODE** COMPUTER SYSTEMS

408 BROAD STREET  
NEVADA CITY, CA 95959

STARLET™ is a registered trademark of NEC

Circle 31 on Reader Service Card

**TRS-80 ALWAYS AT  
SALE PRICES**

**COMPUTER CENTER** WE SHIP  
**FAST!**  
DFW COMPUTER CENTER  
326-MAIN ST.,  
GRAPEVINE, TEXAS 76051  
(817)481-SALE

**OUR TRS-80s Have the Radio Shack warranty**



To get YOUR SALE price, CALL:  
**1-800-433-SALE**

Circle 15 on Reader Service Card



# FILE MANAGEMENT

```

:RETURN
996 CALL 23164,0,23366
:CALL 27795
:CALL 17472
:RETURN
1000 CALL RV
:PRINT @LL,"TOGL"+SPACE$(29)+MD$
:CALL NV
:IF SW>0 THEN SW=0
:GOTO 1014 ELSE AA=0
:BB=0
:SV=X
:X=DO
:KEY1,CHR$(225)
:GOTO 1014
1000 GOSUB 928
:CALL NV
:IF KY<30 OR KY>31 THEN IF KY=25 THEN 1020 ELSE
IF KY=13 AND BB>0 THEN RETURN ELSE IF KY=27
THEN GOSUB 992
:CALL RV
:RETURN ELSE 1002
1010 IF DO=NF THEN 1002 ELSE PRINT @RC(X)+9,MID$(
DR$,RC(X)-30,1)
:IF KY=30 THEN X=X-1 ELSE X=X+1
:IF X>NF THEN X=DO
1012 IF X<DO THEN X=NF
1014 PRINT @RC(X)+9,CHR$(233)
1016 GOTO 1002
1020 F$=F$(X)
:LN=LEN(F$)
:SZ=SZ(X)
:IF MD+SZ=2 OR LN=9 AND MD=3 AND SZ>0 AND
M1-SZ<1171 THEN 1002 ELSE IF LN=9 AND MD=3 AND
MID$(F$,9)="D" AND A+AA=19 THEN 1002 ELSE IF
MID$(F$,9)<"D" THEN IF LN=9 THEN AA=AA-1 ELSE
AA=AA+1
1022 IF LN>9 THEN M1=M1+SZ
:AA=AA-1
:BB=BB-1
:F$(X)=LEFT$(F$,9) ELSE CALL RV
:M1=M1-SZ
:AA=AA+1
:BB=BB+1
:F$(X)=F$+CHR$(0)
1024 PRINT @RC(X),F$
:IF MD=3 THEN CALL NV
:PRINT @194,USING$;M1
:PRINT @234,USING$;AA+B
1026 GOTO 1002
2000 KEYOFF
:CALL 16954
:CALL 17471
:CALL 17006
:IF ERR=7 THEN CLS
:BEEP
:IF M2<500 THEN PRINT @280,"out of memory!"
:MENU ELSE PRINT @280,"clearing memory ...."
:RESUME 8 ELSE IF ERR=18 THEN RESUME 670 ELSE IF
ERR=5 OR ERR=55 THEN BEEP
:IF ERL=102 THEN RESUME 102 ELSE RESUME 400
2002 CLS
:PRINT ERR;ERL
:END

```

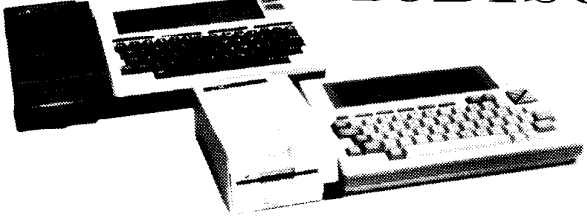

## PICDISC

**Power...**

- Menu driven load/store capability for transferring individual files or total memory to disk.
- CP/M operating system makes available a world of popular software: dBASE II, Wordstar, Supercalc, and much, much more.

**Convenience...**

- Totally portable, lightweight, attaches easily.
- Battery powered, rechargeable, plenty of advance warning on low batteries.
- Fragile connectors protected by our gold high-reliability connector.
- Display 40 x 8 window in 80 x 24; 60-column available.

**Economy...**

- The cost of a PICDISC System represents substantial savings over ROM-based systems. You'll have much greater potential for a smaller investment. Call us today, we'll send our price comparison charts.

**Personal Integrated Computers**  
18013 SkyPark Circle, Ste. D., Irvine, CA 92714

Call Us Today  
About Our Special Offers!

**Disk Drive \$599.00**  
30 Day Refund Guarantee

714-261-0503 call collect  
1-800-421-6300 toll free

CP/M dBase II, Wordstar, Supercalc & T/Maker are trademarks of Digital Research, Ashton-Tate, MicroPro, Sorcim, & T/Maker respectively.

Circle 42 on Reader Service Card

## TRAVEL CASE



Do you carry your laptop with you? Do you want access to it conveniently and quickly? TRAVEL CASE is the answer. When working at your desk or on the plane, convert TRAVEL CASE into a typing easel.

Hard sides protect your computer from bumps. The navy blue nylon case attaches to the computer with Velcro® and removes instantly. Only slightly larger than the computer. It will even fit into your briefcase.

New multi-program ROMs, memory boards and the TRAVEL CASE can make your lightweight M200 or M100 a stand alone computer. The business person, engineer, and student welcome this freedom.

- HARD CASE
- ATTACHES QUICKLY
- DURABLE AND COMPACT
- ALL PORTS ACCESSIBLE
- ALL SWITCHES ACCESSIBLE
- CONVERTS TO TYPING EASEL
- REMOVABLE SHOULDER STRAP



Send a check or money order for \$34.95 plus \$5.00 shipping and handling (Minnesota residents add 6% sales tax). Specify Model 100 or Tandy 200.

**SIMONS PRODUCTS**  
10908 GLEN WILDING LANE  
BLOOMINGTON MN. 55431  
(612) 881-2936

Circle 14 on Reader Service Card

## NEW PRODUCTS (from page 43)

The author of PC Companion's "Dr. DOS" column is a former columnist for Portable 100. Both magazines are published by Camden Communications Inc.

*Sorry About the Explosion* chronicles the rise from oblivion to obscurity of the fictitious Kitchen Table Inc., a composite company embodying the foibles and failings of many well-known industry leaders. Among KTI's products are the BASIC/COBOL compiler, BASICOL, DROSSDOS (a disk operating system compatible with no known computer); Word Whacker (the ultimate in bad word processing programs), and a 7,500MB half-inch hard drive.

*Sorry About the Explosion* is available for \$7.95 from Prentice-Hall Books, Englewood Cliffs, NJ 07632.

Circle No. 84

## An Old Standard Revised

In the computer industry, some products come and go, others stay the

same while still others only get better. Such is the case with Text Power 100 a text formatter from Ultra Soft. Originally marketed by The Covington Group, Ultra Soft picked up the rights to it and have reintroduced it with some new features.

For example, the program now supports a number of different printers. Line feeds either are or are not sent at the end of each line depending on which printer table you're using. Footers and headers now act independently of each other. The plot feature shows page boundaries whenever possible. There are new embedded commands to select where file processing will begin or end.

Text Power 100 is available on cassette or on disk for the Tandy Portable Disk Drive, Tandy DV/1 or Portable Computer Support Group Chipmunk. Program cost is \$49.95 plus \$3 shipping and handling. For owners of Text Power 100 Version 1.38 owners, an upgrade to Version 1.42 is \$24.95.

Contact Ultra Soft, P.O. Box 219, Ste Anne Bellevue, Quebec, Canada H9X 3R9, (514) 457-2917.

Circle No. 83



## Ink-Jet to Go

Diconix Inc., a subsidiary of Eastman Kodak has introduced a portable ink-jet printer.

The new Diconix 150 prints at a draft speed of 150 characters per second (cps) or at near letter quality speed of 50 cps. It measures two by 6.5 by 11 inches and weighs less than four pounds. It comes with 5 C-cell rechargeable batteries.

The Diconix 150 accepts single or continuous form paper. It can produce italic, emphasized, condensed, enlarged and proportional type styles.

The Diconix 150 sells for \$479. Contact Diconix Inc., 3100 Research Blvd., Dayton, OH 45420, (513) 259-3100.

Circle No. 86

# DON'T COMPROMISE!

## Five reasons to buy the Axonix ThinWrite 80 Battery Powered Printer:

- 1. Impact Printing** provides lower media costs, crisper printouts on ANY paper stock, and operation in harsh environments.
- 2. The Wider Carriage** accommodates various form types including multicopy and 10 inch fanfold.
- 3. The ThinWrite Provides Highest Resolution** for Epson/IBM graphics and near letter-quality in a portable printer.
- 4. You Will Have World-Wide Service** available from hundreds of **CENTRONICS** service centers.
- 5. Both Serial and Parallel Communications** are provided as a standard feature.

## See your display in ANY LIGHT!

We backlight your favorite portable with an electroluminescent panel. We guarantee a quick turn around. And you'll receive the same high quality you've come to expect from Axonix.

The Thin E/L is priced from \$200 to \$350 depending on computer model. The ThinWrite 80 Battery Powered Printer is priced at \$449 F.O.B. Salt Lake City, Utah.

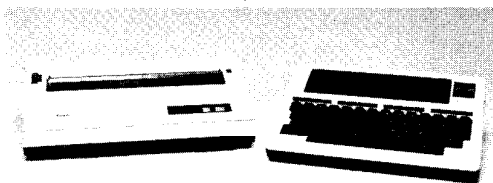

**15 day free trial on standard products.**

**Dealer Inquiries invited.**



**Axonix**

The Portable Peripherals People.

417 Wakara Way  
Salt Lake City, Utah 84108

**Call (801) 582-9271**

Circle 6 on Reader Service Card

# EXPENSE MANAGER (from page 27)

Miles  
0  
? 20347

Just hit Enter if you want to specify the actual number of miles traveled for each entry. The next prompt:

\$/Mile  
0  
? 0.25

is for the rate at which you'll be reimbursed for car mileage. Twenty-five cents per mile is expressed as 0.25 in the above example. This may be left blank if it won't be used. Expense to date is entered after the following prompt:

Cumulative \$  
0  
?

Pressing Enter defaults to zero. All of the above data is stored in the STR.DO file and the program returns to the main Trip menu.

Back at the menu, you may select the Initial option again to make any changes you want. The current values will be displayed on the line following the prompt and before the ? prompt. If the current value is satisfactory, press Enter and it will be retained. If you want to change an item, simply type in the new value.

**2 Input:** By selecting Input, Review or Print the following summary data is displayed:

Description  
Purpose  
Most recent odometer reading  
Mileage reimbursement rate  
Expenses recorded to date  
Push Enter?

Press Enter to continue. The next prompt that appears is for the date associated to the entry to be made:

Date(MO/DA) 01/01?

*Author's Note:* This program was marketed commercially by CSA Software, which has decided to drop out of active support of Kyocera-designed laptop computers. By publishing the program in Portable 100, Trip is being placed in the public domain in support of users of these remarkable machines.

For those who do not wish to type in the program, a tape cassette is available from the author for \$5 — to cover cost of production, packaging, handling and mailing. Send check to the author at P.O. Box 22261. Chattanooga, TN 37422. Be sure to indicate computer type.

TRIP.BA: A program for keeping track of business expenses.

```

10 CLEAR 800
   :DEFINT I-M
   :DEFSTR X-Z
   :Z(0)="0 NOTES"
   :Z(1)="1 MEALS"
   :Z(2)="2 LODGING"
   :Z(3)="3 TRAVEL"
   :Z(4)="4 CAR"
   :Z(5)="5 RENTAL"
   :Z(6)="6 SERVICES"
   :Z(7)="7 SUPPLIES"
   :Z(8)="8 MISC."
   :Z(9)="9 ENTERTAINMENT"
11 XN="Description;"
   :XP="Purpose:"
   :XM="Miles "
   :XR="$/Mile "
   :XA="Amount $"
   :XC="Cumulative $"
   :XD="Date (MO/DA) "
   :XK="Remark:? "
15 CLS
   :PRINT "TRIP Cr84 CSA", , , "1 Initial", ,
     "2 Input", , "3 Review", , "4 PRINT ", ,
     "5 Exit"
   :GOSUB 90
   :KK=VAL(Y)
   :IF KK=1 THEN 80 ELSE IF KK=5 THEN MENU ELSE IF
     KK=4 THEN INPUT "1 Cont. 2 Stop"; IS
20 OPEN "STR"FOR INPUT AS 1
   :LINE INPUT #1, ZN
   :LINE INPUT #1, ZP
   :INPUT #1, NM, R, A
   :CLOSE
22 CLS
   :PRINT ZN
   :PRINT ZP
   :PRINT NM; XM
   :PRINT USING "##.##"; R;
   :PRINT XR
   :PRINT XC; USING "###, ###.##"; A
   :INPUT"Push ENTER"; K
   :IF KK=3 OR KK=4 THEN 100
23 CLS
   :DS=LEFT$(DATE$, 5)
   :PRINT XD; D$;
   :INPUT D$
   :FOR K=0 TO 4
   :PRINT Z(K), Z(K+5)
   :NEXT
25 GOSUB 90
   :X=Y+DS+";"
   :IF Y="0" THEN X=X+";"
   :GOTO35 ELSE IF Y="4" THEN 70
30 PRINT "Amount $";
   :INPUT C
   :X=X+STR$(C)+";"
35 PRINT XK;
   :LINE INPUT N$
   :X=X+N$
   :N$=""
40 PRINT "1 Next, 2 Redo, 3 Quit";
   :GOSUB 90
   :IF Y="2" THEN C=0
   :GOTO 23 ELSE A=A+C
   :C=0

```



# EXPENSE MANAGER

```

41 OPEN "DTR" FOR APPEND AS 1
   :PRINT #1, X
   :CLOSE
   :GOSUB 85
   :IF Y="1" THEN 23 ELSE 15
70 CLS
   :PRINT "1 Mileage, 2 Gas, 3 Other"
   :GOSUB 90
   :IF Y<"1" OR Y>"2" THEN 30
71 INPUT "Miles "; NL
   :IF NM=0 THEN F=NL ELSE F=NL-NM
   :NM=NL
   :NL=0
72 IF Y="1" THEN RX=R
   :PRINT XR; RX;
   :INPUT RX
   :C=RX*F
   :PRINT XA; USING "##, ##.##"; C
   :NS="Miles("+STR$(F)+") @ $" +STR$(RX)+"/Mile"
   :PRINT XK; NS
   :GOTO 76
73 PRINT XA;
   :INPUT C
74 INPUT "Gal."; G
   :IF G>0 THEN F=INT(100*F/G)/100 ELSE 74
75 NS="Gas("+STR$(G)+"Gal.) -" +STR$(F)+
   " Miles/Gal. @" +STR$(NM)+" Miles"
   :PRINT NS
76 X=X+STR$(C)+";"+NS
   :GOTO 40
80 CLS
   :PRINT XN, , ZN
   :X=""
   :LINE INPUT "? "; X
   :IF X<>"" THEN ZN=X
81 PRINT XP, , ZP
   :X=""
   :LINE INPUT "? "; X
   :IF X<>"" THEN ZP=X
82 PRINT XM, , NM
   :INPUT NM
   :PRINT XR, , R
   :INPUT R
   :PRINT XC, , A
   :INPUT A
   :GOSUB 85
   :GOTO 15
85 OPEN "STR" FOR OUTPUT AS 1
   :PRINT #1, ZN
   :PRINT #1, ZP
   :PRINT #1, NM
   :PRINT #1, R
   :PRINT #1, A
   :CLOSE
   :RETURN
90 Y=INKEY$
   :IF Y>"/" AND Y<":" THEN RETURN ELSE 90
100 L=60
   :B=0
   :D=0
   :IF KK=4 THEN GOSUB 250
110 FOR K=0 TO 9
   :OPEN "DTR" FOR INPUT AS 1
   :IF KK=4 THEN 220
120 IF EOF(1) THEN 150 ELSE LINE INPUT #1, X
   :IF VAL(LEFT$(X, 1))<>K THEN 120 ELSE I=INSTR(2,
   X, ":")
   :J=INSTR(I+1, X, ";")
   :DS=MIDS(X, 2, I-2)

```

The current month and day (January 1 in this example) from your computer's internal calendar is automatically displayed in front of the ? prompt. If this is the date you want to use just push Enter, otherwise type in the desired date. The following menu for the type of entry will appear:

```

0 NOTES      5 RENTAL
1 MEALS     6 SERVICES
2 LODGING  7 SUPPLIES
3 TRAVEL   8 MISC.
4 CAR      9 ENTERTAINMENT

```

These expense account categories are numbered from one through nine — notes is item zero. If you wish to use different names, they can be changed in program line 10 to meet your particular preferences. NOTES and CAR expense have some special features. All other items use the same data entry procedure.

To select an option press the appropriate number key. Using LODGING as an example, the following prompt will appear:

Amount \$? 51.92

Type the amount (54.92) after the ? prompt and press Enter. The next prompt:

Remark:? North Side Holiday Inn

allows you to describe the expense and include additional remarks up to 240 characters (six lines on the screen). Press Enter and the following menu appears:

1 Next, 2 Redo, 3 Quit

If the entry just completed is correct, press 1 to file the record and start another record, or push 3 to quit and return to the Trip menu. If there's an error in the record, press 2 to redo it.

The detailed records are stored in a random access memory (RAM) file DTR.DO as a packed string to minimize the amount of memory required. The Trip program can only read and add records to this file, thus avoiding the possibility of losing data. However, you can edit the file as you would any other document file if you're careful to maintain the necessary format illustrated below:  
(item number) (date):(\$ amount);(remarks)

The first character in the string corresponds to the item number (0 to 9) in the selection menu. The date is be-

## EXPENSE MANAGER

tween the first character and the colon (:). The dollar amount is between the colon and semicolon (;), which is followed by the remarks. The beginning number, the colon and semicolon *must* appear in each record.

The use of the NOTES option is similar to the above but doesn't involve the use of an expense item. Each note is limited to 240 characters (six lines). However, several notes can be used consecutively. These notes are formatted and printed at the beginning of the report and can serve a number of uses.

The CAR expense account option has several special features. It shows the following menu:

1 Mileage, 2 Gas, 3 Other

To record expenses like oil or repairs, select 3 for Other. This works just like the expense items previously described. When you select either 1 for Mileage or 2 for Gas the next prompt is:

Miles ? 20668

Enter the current odometer reading. If you entered the reading at the beginning of the trip, the program will

```

:C=VAL(MID$(X, I+1, J-1-I))
:N$=RIGHT$(X, LEN(X)-J)
:B=B+C
130 IF KK=3 THEN CLS
:PRINT Z(K)
:PRINT D$, USING "$$##, ###.##"; C
:PRINT N$ ELSE 161
140 PRINT "1 Next, 2 Quit";
:GOSUB 90
:IF Y="1" THEN 120 ELSE IF Y="2" THEN CLOSE
:GOTO 15 ELSE 140
150 CLOSE
:IF KK=3 THEN NEXT
:GOTO 15
151 IF K<>0 THEN LPRINT TAB(14)" -----"
:LPRINT TAB(14) USING "$$##, ###.##"; B
:D=D+B
:B=0
:L=L+1
:GOSUB 250
152 NEXT
:LPRINT
:LPRINT TAB(8) "TOTAL"; TAB(14) USING
"$$##, ###.##"; D
:GOTO 15
160 IF L>59 THEN GOSUB 250
161 LPRINT TAB(8) D$;
:IF K=0 THEN M=15
:N=58 ELSE LPRINT TAB(14) USING "$$##, ###.##"; C;
:M=27
:N=46

```

# BATTERIES INCLUDED

A 1200-baud portable modem that's big enough to handle all your computing needs.

Introducing the TravelComm 1200. The battery-powered, easy to use, 1200-baud modem for computer users on the go. And it's available now.

Whether you're checking your E-mail, searching through an information service database, or sending a late-breaking story to the news desk, the TravelComm 1200 can help you do it faster. And because the TravelComm 1200 communicates at 1200-baud—four times the rate of 300-baud modems—it can reduce your connect charges by as much as 75%.

Dealer inquiries invited. OEM versions available.



It's affordably priced at \$299 and comes with a 90-day unconditional warranty. To order yours, call (516) 261-0423.

Marketed exclusively by:  
**TechniGroup Inc.**  
 16 Green Acre Lane, Northport, NY 11768  
 Telephone (516) 261-0423; Telex 4995541

## EXPENSE MANAGER

```

162 GOSUB 270
:IF K=0 THEN LPRINT
:L=L+1
:GOTO 120 ELSE 120
220 LPRINT
:LPRINT TAB(8) RIGHT$(Z(K), LEN(Z(K))-2)+": "
:L=L+2
:GOTO 120
250 L=L+1
:IF L<60 THEN RETURN ELSE IF IS<2 THEN FOR J=L
TO 66
:LPRINT
:NEXT ELSE INPUT "Change Paper and push ENTER"; J
251 FOR J=1 TO 3
:LPRINT
:NEXT
:LPRINT TAB(40-LEN(ZN)/2); ZN
:LPRINT TAB(40-LEN(ZP)/2); ZP
:LPRINT
:L=7
:RETURN
270 I=LEN(N$)
:IF I<N THEN X=N$
:N$=""
:GOTO 273 ELSE J=N
271 IF MID$(N$, J, 1)<>" " THEN J=J-1
:GOTO 271 ELSE X=LEFT$(N$, J)
:N$=RIGHT$(N$, I-J)
273 LPRINT TAB(M) X
:GOSUB 250
:IF N$>" " THEN 270 ELSE RETURN
    
```

calculate the number of miles traveled.

If the Mileage option is selected, the next prompt is:

\$/Mile .25?

The reimbursement rate specified during the initial set up (.25) is displayed after the \$/Mile prompt and before the question mark. To use this rate press Enter; otherwise, type in the new value. The amount will be automatically calculated and displayed with a remark indicating the number of miles traveled and the reimbursement rate followed by the prompt for the next operation:

Amount \$ 80.25

Remarks: Miles ( 321) @ \$ .25/Mile  
1 Next, 2 Redo, 3 Quit

For the Gas option the next prompt will be:

Amount \$? 25.37

Enter the dollar amount and at the next prompt:

Gal.? 21.3

### INVEST BY COMPUTER

Central Asset Account  
National Network  
FREE On-Line Access

Harness your computer's power with UNISAVE

- Deep Discount Brokerage Rates
- Money Market Sweep Account
- Unlimited Check Writing
- Portfolio Accounting
- Open with only \$1,000

Many FREE Computer Services  
FREE Access to View Account  
FREE Entry of Brokerage Orders  
NO Application Fee  
NO Software Purchase Required  
On-Line Investment Research

Data for over 40,000 securities  
Quotes - Stock Performance Ratings  
Research Fees based on connect time

#### Discount Stock Commissions

Up to 240 Shares... \$30.00  
241 to 799 Shares... 12 1/2¢ per sh  
800 to 1099 Shares... 10 ¢ per sh  
1100 to 2099 Shares... 8 ¢ per sh  
2100 to 3099 Shares... 7 ¢ per sh  
3100 Shares or More... 5 ¢ per sh

**Call 1-800-UMC-SAVE**  
**Unified Management**  
**Corporation**

Guaranty Building • Indianapolis IN 46204  
MEMBER: Midwest Stock Exchange NASD SIPC



**NEW!**  
For Model 100  
NEC PC-8201

**SafeSkin™** **KEYBOARD  
PROTECTOR**

*Finally! A keyboard cover that remains in place during use!*

SafeSkin prevents costly downtime and repairs due to liquid spills, dust, smoke, cigarette ashes, paper clips, staples and other environmental hazards. SafeSkin is made of ultra-thin, ultra-tough, clear flexible plastic, molded to fit every key and contour, allowing normal key response and feel. This custom fit cover is easily removed for cleaning and gives years of dependable service. Available for the Model 100, NEC PC-8201, IBM PC, XT, AT, Apple, C64 and many other popular computer models. Send 29.95, Check or M.O., Visa & MC include expiration date. Specify computer type. Dealer inquiries invited. Free brochure available.

MERRITT COMPUTER PRODUCTS, INC.

2925 LBJ Fwy., Suite 180 / Dallas, Texas 75234 / (214) 942-1142

Circle 73 on Reader Service Card

Circle 27 on Reader Service Card

# DATA ACQUISITION & CONTROL

Battery powered interface for the Model 100. Gives Analog and Digital I/O capabilities to your Radio Shack, NEC or Epson. Whether in the lab or in the field, Data Acquisition and Process Control are now more affordable than ever. Easy to program using BASIC input and output statements. Systems from \$549.

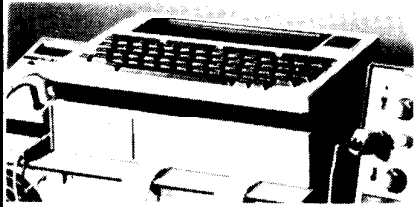

- Expansion boards available:
  - High Accuracy 12 Bit Analog I/O
  - Digital I/O-Counter/Timer
  - Combination Analog & Digital I/O
  - Relays, TRIACS, Opto Isolator, Thermocouple, etc.
- Serial Interface available--communicates with any computer. (IBM, Apple, etc.)

**Complete PL-100 System includes:**

- Expansion Chasis (holds 3 boards)
- Combination I/O board with
  - 16 Channel 8 or 12 Bit A/D
  - 4 Channel 8 Bit Analog Output
  - 4 Analog Level Sense Inputs
  - 16 Bits Digital Output
  - 16 Bits Digital Input
- Battery Charger / AC Adapter
- 2 Empty expansion slots
- Interface Cables
- Uses rechargeable batteries
- Provides power to the computer

Call the factory.

**ELEXOR ASSOCIATES**

**(201) 299-1615  
P.O. Box 246,  
Morris Plains, NJ 07950**

# New PORTA-PRO

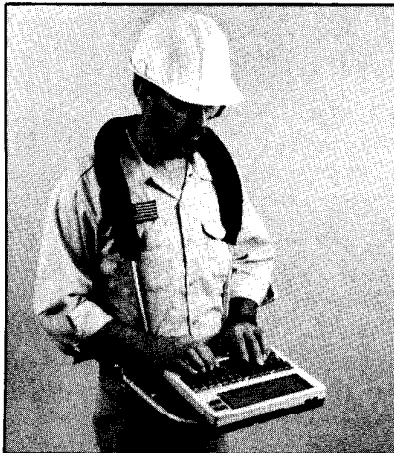

The **PORTA-PRO** is a light weight adjustable frame for lap computers. At last, true mobility. The **PORTA-PRO** is a must for the professional who has already recognized the convenience of a lap computer. The **PORTA-PRO** lets you use your lap computer anywhere.

The **PORTA-PRO** is fully adjustable. The padded, metal frame and secure computer mount is

designed for maximum comfort. Available for the Model 100. Adaptable for other models.

Send \$99.95 plus \$5.00 for shipping.

**HEARTHSIDE ENTERPRISES**, P.O. Box 609, No. Amherst, MA 01059

Name \_\_\_\_\_  
Street \_\_\_\_\_  
City \_\_\_\_\_ State \_\_\_\_\_ Zip \_\_\_\_\_

# EXPENSE MANAGER

the number of gallons to fill the gas tank. The program will calculate the miles per gallon and record the comments:

Gas (21.3Gal.) - 15.07 Miles/Gal. @ 20668 Miles

1 Next, 2 Redo, 3 Quit

**3 Review:** When the Review option is selected the records are displayed one at a time in the order of the accounts in the menu and by entry sequence. The records are displayed in the following format:

Account	Date	Amount
Remarks		
1 Next, 2 Quit		

**4 Print:** The program includes a procedure to arrange items by account in the order the records were entered and print them in an 80-column format with page headings and margins. The total amount in each account and the grand total for all accounts are printed. Text entries are formatted and printed with left justification in the context of the particular item to which they apply. You'll be prompted:

1 Cont., 2 Stop

If you're using continuous form paper, select 1. To stop printing at the end of each page select 2. The latter will display the prompt:

Change paper and push Enter?

at the beginning of each page. Insert a new piece of paper, press Enter, and printing will resume.

## WHY IT WORKS

An important consideration in designing the program was to conserve as much memory as possible. To minimize program size, multiple statements are used in each program line and all non-essential spaces and comments are omitted. This makes it difficult to follow the program's logic. The following discussion will explain the location of principal parts of the program and describe some important programming features.

Lines 10 and 11 define variable types and assign variable names. This reduces program length by permitting use of general logic in many places as well as avoiding repeating labels.



## EXPENSE MANAGER

Lines 15 through 22 are responsible for displaying the main menu, reading the summary data (STR) and then displaying the current summary.

Lines 23 through 41 are used for data input from the keyboard, development of the packed data string (X) record and to append the record to the data file (DTR). Note that the string (X) is concatenated progressively as elements of the record are entered. Elements are separated by a colon (:), or semicolon (;). This packing technique uses minimum space for storing records and provides for reconstruction of the elements by unpacking in line 120.

Line 23 uses the BASIC DATE\$ function to read the current date maintained by the computer. This is used as the default value. The DATE\$ function serves the same purpose in the NEC, Olivetti and Tandy computers, however, the form is different. The Tandy and Olivetti computers return the date string in the MM/DD/YY form. The NEC starts with the year: YY/MM/DD. To extract the month/day part of the string correctly for the NEC computer, change D\$=LEFT\$(DATE\$,5) in line 23 to D\$=RIGHT\$(DATE\$,5).

The special logic for the CAR account used to compute gas mileage is contained in lines 70 through 76.

Lines 80 through 82 are used to provide the initial input to the summary file (STR).

Line 85 is a subroutine used to store the summary file (STR).

Line 90 is a compact keyboard input subroutine that allows single key-stroke selection of numbered items from menus. The INKEY\$ function is used to capture the incoming key-stroke, and it is tested to be sure that it's a number from zero to nine occurring between / and < in the sequence of ASCII characters. If the test is positive, execution returns to the calling location. Otherwise another character is read from the keyboard.

Lines 100 through 273 review records on the screen or send them to a printer. Lines 100 through 120, common to both procedures, sort records by account and reconstitute record elements by unpacking the string data. To minimize memory requirements, no more than one record is processed in the program at any time. Record sorting by account is accomplished by making a separate sequential search through all records for each account. Screen display logic is in lines 130 through 150 and printer output is in lines 151 through 273.

Happy traveling. □

# YOUR INDEPENDENT ONE CHOICE

PG Design RAM modules have become the number one choice for Model 100, Tandy 200 users, not just because more people are using PG Design RAMs than any other brand—But because our name has become synonymous with PREMIUM QUALITY, RELIABILITY, and IMMEDIATE CUSTOMER SERVICE.

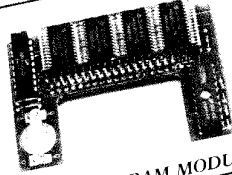

MODEL 100 64K RAM MODULE



MODEL 100 8K RAM MODULE

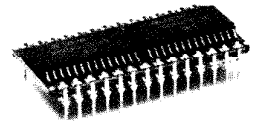

TANDY 200 24K RAM MODULE

When you purchase any PG Design RAM module, you're buying directly from the people who design, manufacture and service the product.

We develop the most advanced products of their kind by using the latest technology and the highest quality components available. Before we bring any product to market, it is carefully evaluated in the field by professionals. If it doesn't meet their standards, it doesn't meet ours. And when we finally bring our product to market, it's the finished product. It works as we say it will, and it will keep on working reliably. "Our reputation for excellence is riding on each and every RAM module we ship."

Whether it's an 8K or 64K RAM module to expand the memory of your Model 100 or a 24K RAM module for your Tandy 200, be assured you are buying the best when you buy PG Design RAM modules.

Model 100  
64K RAM module—\$375 ea. 32K RAM module —\$250 ea. 32K upgrade—\$150  
8K RAM modules—\$29.95 ea. Set of three \$84.00 [available for NEC 8201A]

Tandy 200  
24K RAM modules—\$139 ea. \$135 ea. two or more

We absolutely guarantee the quality and perfect performance of all PG Design RAM modules or your money back!

We supply easy to follow instructions with each of our products. And, we are eager to assist you on the phone if you should need help with the installation or operation of your RAM module.

To order, call us (313/727-2744), or write. All orders are shipped within five working days after receiving your order. We accept VISA, Master Card, personal checks or money orders.

PG Design Electronics, Inc. 66040 Gratiot, Richmond, Michigan 48062 (313) 727-2744  
Dealer inquiries invited. TANDY is a registered trademark of TANDY CORP.

# PG Design

# What's This Bell 103 Thing, Anyway?

The Model 100 is the easiest computer to use for telecommunications. Take an MS-DOS computer: To telecommunicate, you have a choice of modems (Hayes-compatible, Tandy-compatible or other), a choice of software (commercial or public-domain) and even a choice of serial ports.

With the Model 100 and Tandy 200, you don't have to make any choices. The modem's built in, the software's in ROM, and the only accessory you need is a direct-connect modem cable. CompuServe or Company Mainframe, here I come!

Alas, that blissful state doesn't last forever. Sooner or later, you'll start running into some difficult choices. Is XMODEM transfer necessary? How about higher-speed modems? What about overseas conventions?

Before you begin perusing advanced telecommunications manuals, read through our mini-glossary of telecom terms. This list, though short, should explain all of the concepts used by the Tandy laptops. This month, we'll explain the terms used to describe modem configurations; next month, we'll venture into the realm of data transmission protocols.

## BELL 103, BELL 212A

A modem isn't a modem isn't a modem. Acoustic modulator-demodulators (which is what *modem* stands for) rely on certain standards, or conventions, for operation. These conventions are usually described as Bell 103, Bell 202 and Bell 212A.

The Tandy laptop built-in modems are all of the Bell 103 variety. That means that they transmit 300 bits per second (bps) of information, can transmit both the answer and originate acoustic tones, in true full and half duplex. Bell 103 modems operate using the *frequency-shift keying* (FSK) method of data transmission; one tone is used for sending a binary one and a different tone for binary zero. If you listen on an extension phone during a telecommunications session, you can hear the constant tones while the system is sit-

ting idle, and the rapid changes in pitch as data is transmitted.

There's another type of 300-bps modem that you might encounter: the Bell 113. This variant is FSK, originate-only, half-duplex only — so if you're connecting up to a system using Bell 113, be sure to be set for answer and half-duplex.

The new fad is the 1,200-bps modem that transmits data at up to four times the speed of a Bell 103 modem. A 1,200-bps modem, though, isn't just a 300-bps modem that works four times as fast. The prevailing standard for these faster modems, Bell 212A, specifies an entirely different method of data transmission, *differential phase shift keying*, or DPSK. This method uses changes in the signal phase, instead of changes in pitch, to identify the two binary states. If you listen in on a Bell 212A transmission, you'll only hear the two pitches: 2,250 Hz for originate mode, 1,150 Hz for answer mode.

Otherwise, the Bell 212A standard is very similar to the Bell 103. It specifies that the modem can use both the answer and originate tones, and both full and half duplex. It can also emulate the Bell 103 standard, so you can use most Bell 212A modems to talk to a 300-bps system.

During telecommunications, two modems have to be able to talk — and listen — simultaneously. By using two completely different acoustic tones (one high, the other low), two modems are able to transmit at the same time while still being able to receive the other's signal. When two modems are establishing contact, the *answer* modem sends out its tone first; the *originate* modem sends its tone after it hears the *answer* signal.

With the Bell 103-convention 300-bps modem, like in the Tandy laptops, the low tone is named *originate*, and uses 1,070 Hz for a binary zero and 1,270 Hz for a binary one. The *answer*, or high tone, uses 2,025 Hz for binary zero and 2,225 for binary one.

By convention, the *answer* tone is used by timesharing mainframes and *originate* is used by remote terminals.

The Model 100 can use either system, as determined by a physical slide switch; the Tandy 200 and Tandy 600 change modes via software. So if you're calling an online service, set your modem to *originate*.

## HALF DUPLEX, FULL DUPLEX

Half and full duplex are holdovers from the early days of computer communications. A good analogy is the citizens-band radio, popular in the 1970s. On a given channel only one person could talk at a time, and when he was talking he couldn't listen. When he was through he said "over," or something like that, and released the microphone until the other party said "over." That's half-duplex.

Full-duplex is like a modern day telephone. Both parties can be talking, and listening, simultaneously. Without getting into the technical specifics of duplex, nearly all microcomputer communications take place in full-duplex mode. The F4 button on the Model 100 and Tandy 200, which appears to toggle between half and full duplex, actually doesn't. The key really switches between *local echo on* and *off*. In full-duplex mode, what you type on your keyboard doesn't appear on your screen. Instead, the remote computer retransmits what you send, so you can check it for accuracy. In that situation, you want to have *local echo off*, so that our screen will only show what the remote computer sends to you.

If the remote computer doesn't echo what you're sending — and many microcomputer software packages don't echo — switch to half-duplex, or *local echo on*. That way, your Model 100 copies what you're transmitting to the screen.

Rule of thumb: If you don't see what you're typing, switch to half-duplex. If you see two of everything, switch to full-duplex.

Finally, don't confuse *local echo* for the Model 100's *Echo* key (F5) in Telcom. It's used to copy what you receive to a connected parallel printer.

— Alan L. Zeichick

# omni

## The Uncommon Carrier

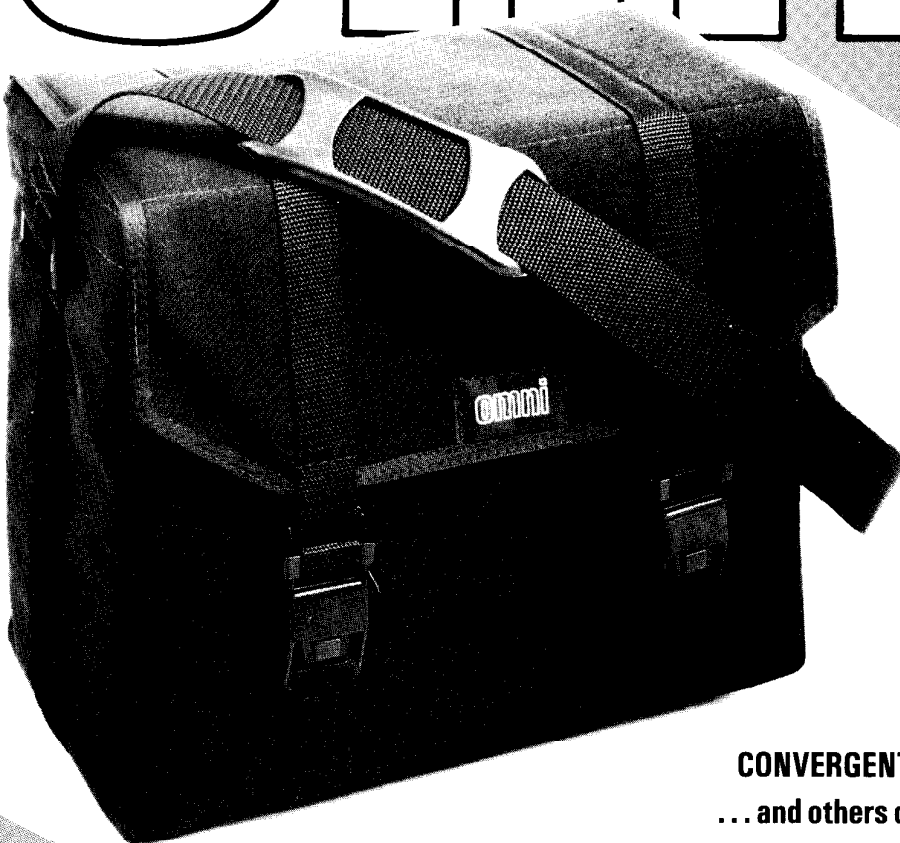

### FOR YOUR...

TANDY 100  
TANDY 200  
NEC 8201A  
NEC STARLET  
EPSON HX-20  
EPSON HX-40  
EPSON GENEVA  
SORD IS-11C  
CASIO FP-200  
OLIVETTI M-10  
TELXON PTC-7000  
SONY TYPECODER  
GRID "COMPASS" SERIES  
CONVERGENT TECHNOLOGIES WORKSLATE  
... and others of similar size and configuration

**"The most accommodating  
laptop computer system  
carrying case on the market!"**

**WANT TO  
KNOW MORE?**

**For descriptive literature and ordering information, write to:**

**omni**enterprises  
TM

SUITE 29, 8200 W. MANCHESTER AVE.  
PLAYA DEL REY, CALIFORNIA 90293

Circle 8 on Reader Service Card

# SIGEA COMMUNICATIONS SOLUTIONS

*We specialize in easy to use solutions  
for complicated communications problems.*

Our most popular solution is Telecommuter<sup>®</sup>, a new kind of integrated software for the IBM PC and compatible computers. This product is very easy to learn and use — just as easy as your Model 100 or Tandy 200, in fact. Yet it has all the communications and word processing power you will probably ever need or use.

Here are some interesting Sigea solutions:

- QuikTrip Corporation needed to streamline its convenience store order entry process. Our solution was to put TC-plus on personal computers in 270 stores to upload stock orders to 'collector' computers running TC-corporate. Now each store manager can prepare his orders off line, then upload them with one keystroke!
- AgriData Resources, Inc. hired Sigea to automate access to and control over its AgriData Network, a large on-line data base (over 20,000 reports) and electronic mail (including MCI Mail) service. Now AgriData subscribers can use this large system with single keystroke convenience!

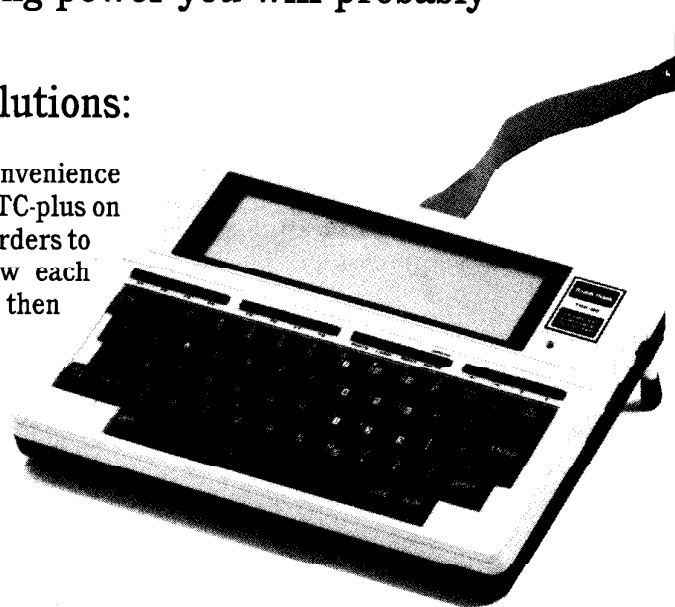

VISA and MASTERCARD  
accepted.

**SO SIMPLE**

**SIGEA SYSTEMS, INC.**

19 Pelham Road, Weston, MA 02193 (617) 647-1099





- An IBM Marketing Rep uses a Sigea solution — the Executive Information System — to tie 60 PC Convertibles into his IBM PC AT host computer. This system provides host software for the IBM PC AT and 'one button' access to the host, MCI Mail and Dow Jones for the Convertibles.

 The best way to find out more about Telecommuter is to try it. Call our support line — (617) 647-1099 — and ask for a free demo disk.

We'll be glad to show you what we can do to make your work style more pleasant ... and more productive!

**SUPER ROM**  
Lucid Spreadsheet Write ROM Database Outliner

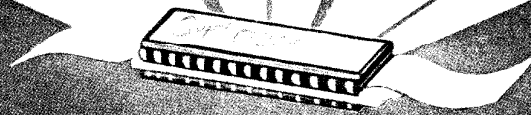

"Boots the  
Tandy Portable Drive  
with one button"

**NOW YOU CAN REALLY HAVE IT ALL!**

**All on one ROM. Truly the finest four programs  
available for the Model 100 — guaranteed.  
Try it for 30 days. If you aren't blown away by the  
excellence return it for a full refund.**

**\$199<sup>95</sup>**

The four best programs for the Model 100 all on one ROM. 32K of power without using any RAM for program storage. This is the PCSG Snap-In ROM that just presses easily into the little ROM socket in the compartment on the back. You access the four right from the main menu like built-ins.

**Write ROM** the definitive word processor for the Model 100. Function key formatting or dot commands. Search and replace. Library feature — inserts words, phrases or whole documents into text from just a code. MAP lets you see a picture of your document. In all there are 60 features and functions. No one can claim faster operation. FORM lets you create interactive forms with on-screen prompts that you can answer from the keyboard. Nothing else for the Model 100 compares with the features of Write ROM. Exactly the same as the Write ROM sold as a single program. Infoworld says it "makes the Model 100 a viable writing unit ... sur-

passed our highest expectations for quality and clarity."

**Lucid Spreadsheet:** This is the one PICO magazine says "blows Multiplan right out of the socket" and Infoworld performance rated as "excellent" and said "makes the Model 100 compute." Gives you features you cannot get with Lotus 123. Lets you build spreadsheets in your Model 100 that would consume 140-150K on a desktop. Program generating capability with no programming knowledge required. Variable column widths. Includes find and sort with function key control. It's fast, recalculates like lightning. No feature has been taken from the original, only new ones added.

**Database:** This is a relational data base like no other. You can do everything from mailing lists to invoices. No complicated pseudo-coding, you create input screens as simply as typing into TEXT. You are not limited by size; you can have as large an input screen as you wish. Prints out reports or forms, getting information from as many files as

you like. Complete math between fields. Total interface with Lucid worksheets.

**Outliner:** Does everything that Think-tank does on a PC but a whole lot better. Includes a Sort for your headlines. Lets you have headlines of up to 240 characters. Has cloning, hoisting and sideways scroll up to 250 characters. Like Lucid, this one sets a new standard for outliners. This is the way to plan and organize your projects.

Present Lucid and Write ROM owners can upgrade for \$150 If you have both it's \$125

As usual PCSG sells the Super ROM on a thirty day guarantee. If for any reason you are not satisfied, simply return it for a full refund.

We are excited about this product. Super ROM gives the Model 100 the true power of a desktop. No other multi-program ROM has software that compares. But don't take our word for it. We invite you to make that comparison yourself. Priced at \$199.95 on Snap-In ROM.

*Got stuck with somebody else's multi-ROM?  
We'll upgrade it for \$150*

**(214) 351-0564**

**PORTABLE COMPUTER SUPPORT GROUP**

11035 Harry Hines Blvd., #206, Dallas, TX 75229

© PCSG

MC, Visa, American Express, Check, or C.O.D.

Circle 41 on Reader Service Card