

WinOnLine™ Review™ is a publication of Windows OnLine™ (BBS). Copyright © 1992-1993 All Rights Reserved

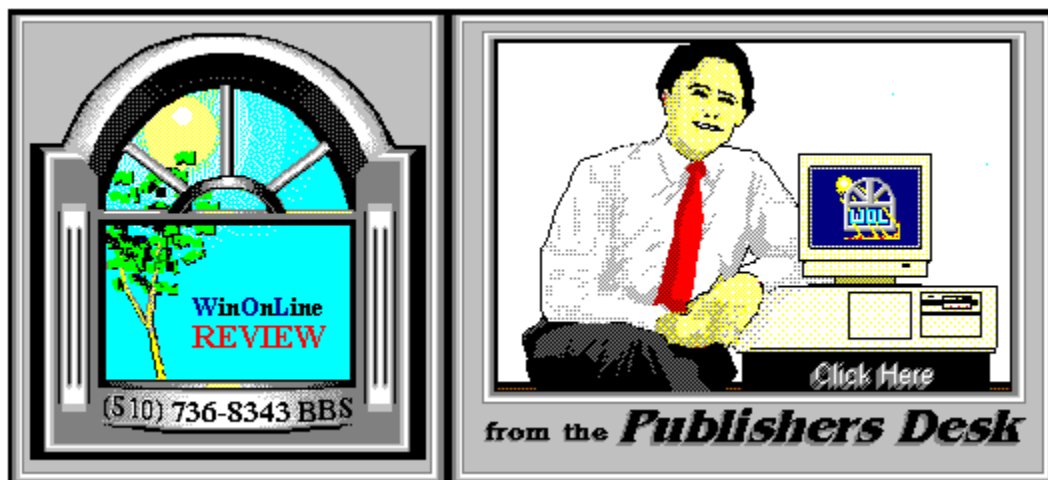

*(Click Above For Table Of Contents)*

## About **Windows OnLine™**

**Windows OnLine™** is an on-line (modem) service dedicated to supporting Windows users and Windows network professionals. **WOL** prides itself on having the most complete and up-to-date library of Windows shareware in the world. We have over 9,000 Windows 3.x programs and files to download. With **17** phone lines, (all equipped with **US Robotics high speed dual standard modems**), operating 24 hours a day, 365 days a year.

**WOL** is growing rapidly with **thousands of callers** directly using the service. We advertise in national publications as well as several computer newspapers. **Call today** and see why **WOL** is the ***Worlds Premiere Windows On-line Service.***



## About **Windows OnLine™ REVIEW**

The **Windows OnLine™ REVIEW (WOLR)** is an electronic magazine that is distributed

worldwide to major on-line services each month. It is estimated that each issue is read by 50,000 on-line and network users. (It is reported that there are over 50,000 BBS's in the USA alone as of 1992). This unique creation is actually a Windows HELP file. All Windows users can view it with its **hypertext, built-in search, and pop-up color graphics**. The **REVIEW's** articles are limited in scope to allow us to present to our readers both a diversity information and to maintain a manageable file size.

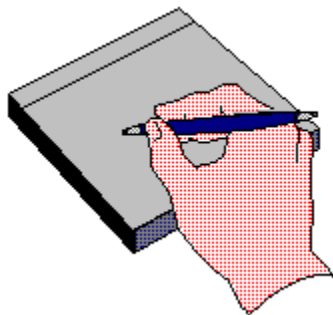

*Why not*

## **Write for Windows OnLine™**

Do you like to test shareware programs? Do you enjoy giving opinions on the latest commercial Windows software? Do you have an interest in Windows software, hardware, programming, etc., and the time to write an article or review? Do you like working with graphics? We are interested in adding a few quality Freelance or Staff writers for

### **WinOnLine™ Review™** and the **WinOnLine™ Review™ Shareware Edition**

Freelance writers can submit their article whenever they wish and are only required to include a .RTF or .DOC file and the .BMP graphics for their article. We will prepare your help file for you. **You can become part of our publication, so call us today (voice) 510-736-4376.** You can also leave a message on WOL (BBS) in Conference 4 address it to the Sysop, Randy Wong, or Bob Gollihur.



## **Copyright © Information**

The **REVIEW** is a product of,

**Windows OnLine™**, no reprinting of any portion of this publication is permitted without the express written permission of Frank J. Mahaney of **Windows OnLine™**.

Sysops and Corporations **may freely offer the .ZIP file for download** by their users. You **may not display the contained .HLP file** as bulletins, news, help files, etc., on any BBS or network, nor are you permitted such reprinting or display of these files, except as otherwise expressly granted, in writing, by **Windows OnLine™**. Subscriptions are available to Corporations who wish to offer the HLP file on their Windows Networks. For subscription information call our voice number (510) 736-4376.

All articles are copyrighted by their authors and upon publication all rights are owned by **Windows OnLine™**. Opinions presented herein are those of the individual author and do not necessarily reflect the opinions of **Windows OnLine™** or the **REVIEW**.



***Call Windows OnLine™ Today!***

**(510) 736-8343** (BBS)

(510)736-4376 Voice/Fax

The contents of this issue and all issues of the REVIEW are copyrighted by Windows OnLine™ and Frank J. Mahaney  
All right reserved Copyright © 1992-1993, Windows OnLine™

**Publisher : Frank Mahaney      Editor : Randy Wong**

***Call Windows OnLine™ today!***

**(510) 736-8343 bbs**

**Frank J. Mahaney**

**Publisher**

**(510) 736-4376 Voice/Fax**

**Windows OnLine™**

**Box 1614**

**Danville, CA 94526-6614**

**Copyright © 1992-1993, Windows Online™**



Tami Brydone-Jack

Ed Hoffman

Steve Peschka

Bob Gollhur

Rich Young

William Brown

Publisher : Frank Mahaney

Front WOL Logo : Derek Westfall

Graphics and Design : Randy Wong



**HAPPY INDEPENDENCE DAY  
!!**



Windows OnLine has created a weekly magazine, the

*WinOnLine™ REVIEW™ Shareware Edition,*

which is strictly shareware to go. Going on Issue #15, this magazine contains:

Shareware product briefs

A shareware Review or two

What's new in Windows shareware files

and a few interesting words from *Wolly*. ... "Who's he"?



If you have not read the **WinOnLine™ REVIEW™ Shareware Edition** magazine, pick up the file WOLRSx.ZIP, it's **FREE!**



I would like to thank everyone who voted for the best Bulletin Board System (BBS). Hopefully, it was **Windows OnLine™ (BBS)**. Special thanks to the people who voted for us. Best wishes to those lucky people who have won the prizes. Once we get the results from BoardWatch on their poll, I will let you know.

Don't forget, please drop by and visit us. You may find something you like. Until next time, happy computing!



*Frank J. Mahaney*  
*Publisher*



## Cover Story



(Click)

## In this Issue:

(Click all Buttons)

### *News*



**Shareware Briefs,** by *Wolly*  
**Shareware Choices For June!**

### *Features*



**Working Smarter In WordPerfect,** by Tami Brydone-Jack

### *Commercial Reviews*



**Colorado Tape Backup**, by Ed Hoffman



**MicroPhone Pro**, by Rich Young



**Golden Retriever**, by Bob Gollihur



**ATI Ultra Pro**, by Ed Hoffman



**Sketcher**, by Tami Brydone-Jack



**Alki Master Word**, by Ed Hoffman

## *The Marketplace*



**Modem Specials**

US Robotics *High Speed Modems*

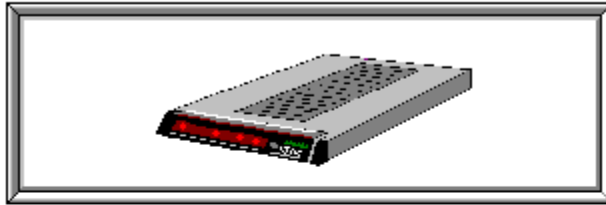

***The Best For Less !!***

**\$179.95 - USR Sportster Internal Modem 14,400 bps v.32bis**

**\$199.95 - USR Sportster Internal FAX/Modem 14,400 bps v.32bis**  
(Includes WinFaxLite)

USR 14,400 modems will allow compressed files transfer at speeds of 1,650 CPS

*Windows OnLine™ sells all US Robotics products - Call us with your order*

*Consider membership with Windows OnLine™ for the latest Windows shareware and now outstanding modems at fabulous prices.*



## Wolly's Shareware Choices for June!

(The following were extracted from several articles contained in the WinOnLine™ Review Shareware Edition)

### CLEANUP

Hoover for the 'puter



**Drive clogged???** Forget Drano, get Cleanup! Take Wolly's word for it, this is the **best file dupe destroyer yet**. Super interface, nice button bars to take you where you want to go quick. Scans across drives and merges the results. **Graphs** your fattest sub-directories. **Tags all 0-byte and BAK files** at a single click. Leaps tall buildings in a single bound! (Sorry, got carried away!) Download **CLUPW100.ZIP** (112K) and check it out. You'll be glad you did. Registration is **\$32.90** including shipping. Like the graphic? You can even get a "Hoover invented it . . . We made it Windows Compatible" T-shirt for \$19.95 more.

### LOOPS

Francais loop de loop

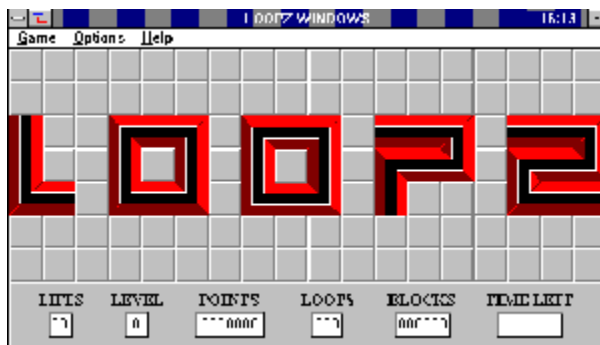

This game from across the pond is **great fun!** The author makes a deserved parallel to Tetris.

Instead of falling blocks, you are presented with a piece which can be rotated as with Tetris, but **your objective is creating "loops"**, a shape that eventually connects. Once made, the completed loop disappears with a bizarre sound. Simple in concept as Tetris, and just as addictive. You'd *better* be addicted, since once you've begun the game there is no way to exit until your time and lives have run out (doesn't take very long at idle). After a bit, larger pieces appear to really puzzle you (pun intended); you can adjust the game level to beginner if need be. **Wolly had fun with this one**, and suggests you give it a try. **LOOPZ11.ZIP** (110K) is **freeware** from Christopher Yvon of Sceaux, France.

## LOOK AND LISTEN ANIMALS

Rough around the edges, but will the kid care?



**Precious little shareware is issued for "little precious"**. The **Look and Listen™** series recently posted on Windows OnLine includes a number of audio-visual distractions for your very own wunderkind. This example combines an audio introduction and description of each of the **ten animals** as they appear on the screen. Audio is okay, but the illustrations are pretty rough, and may or may not also have the name of the animal printed within the picture. The **Look and Listen™** series consists of additional modules including 123, ABC, Colors, Shapes, Opposites, and Dinosaurs. Registration for the seven programs in the series is \$39.80. If you have little ones you might want to download **LOOKANIM.ZIP** (328K) or one of the other flavors of kiddie komputer koddlers listed in the New Windows Files section of **WOLRS**. Registration is **\$13.95** (\$9.95 plus \$4.00 shipping) for this one.

## PAULIE PYTHON

A slithering good time

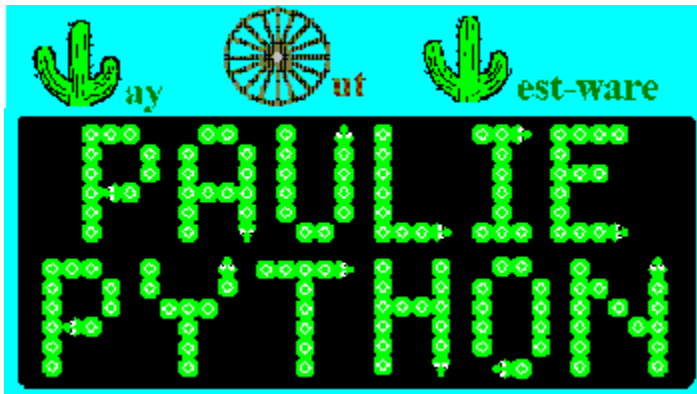

A cute **Windows** game. Paulie Python (no relation to Monty) crawls about **gobbling animals and avoid bloody collisions** with obstacles. No, it's not brain surgery and requires little mental capacity, but then perhaps that's why Wolly liked it. Author Craig P. Thompson gives you two options to register Paulie: **\$5.00** for the shareware versions as you see it, or **\$14.95** for the "commercial" version. With it you can **design your own screens** as well as get more lives out of Paulie before he croaks from your incompetence. **PPYTHON.ZIP** (49K) can be some fun, and harkens back to before video games became more complicated than algebra.

## SALVATION

from Progman & FileMgr



Wolly can't tell you everything there is to know about Salvation in this short format. Suffice it to say that it's a **program and file manager replacement** with many features you might find very handy. It can also act as your Windows **shell** if you wish. A single, but expandable file window subs for file manager, and prescribed sets of buttons (called button pages) with selectable icons and titles replace your program groups. A conversion program is included to install all your current groups as button pages within Salvation.

Some nice features include **security levels, a file finder, some nice disk and file utilities, deferred deletes**, and much, much more. In the brief time Wolly had to utilize Salvation he could judge it to be a credible manner in which to conduct Windows operations, though as with any change, it would take a bit of getting used to. **SALVT116.ZIP** (245K) is an interesting approach to Windows for a reasonable fee of **\$20.00**.

# MORE CONTROL / ICON LIBRARY BUILDER

An old friend and a new one

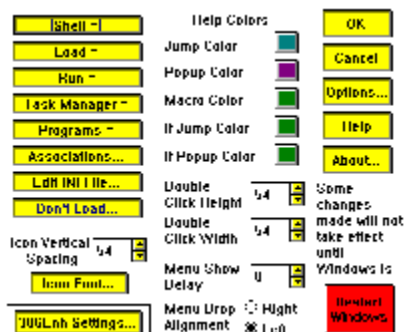

More Control was a welcome freeware program that gave you access to easily make **changes to Windows features without getting your hands dirty with INI files**. A few more features have been added since it and Windows 3.1 came out, and it is now shareware with a registration fee of **\$12.50\***. **Associations, pop-up colors, icon fonts and spacing, double-click specifications**, these are but a few of the Windows convenience tweaks you can pull off from More Control. Proper installation of the program will conveniently place the icon within your Control Panel where it rightly belongs.



Icon Library Builder is also included in **MCICLB.ZIP** (166K) and is **a treat for the icon fans in the crowd**. Extract icons from DLLs, EXEs, ICOs and create ICL (icon library) files of giant proportions. **Icons can be exported as BMPs** to be edited with Paintbrush and the like. The interface is very intuitive and operations are smooth. It is also priced at **\$12.50\***, but Sloop Software will register them **\*both for \$20.00**.

## FONT SPEC

The cure for fontitis



There are only a few good font management/cataloging programs. Now there is one more. Font Spec brings a **sharp 3-D looking interface with clean and fast font viewing**. The sample printing seemed faster to Wolly than past experiences with other programs, though no benchmarks were done. The viewscreen in the main program window can display your selection in sizes from 6 to 98 points, in regular, italic, bold or bold italic. Five samples can be selected, including sample text, character set, a paragraph, and two which are user-defined.

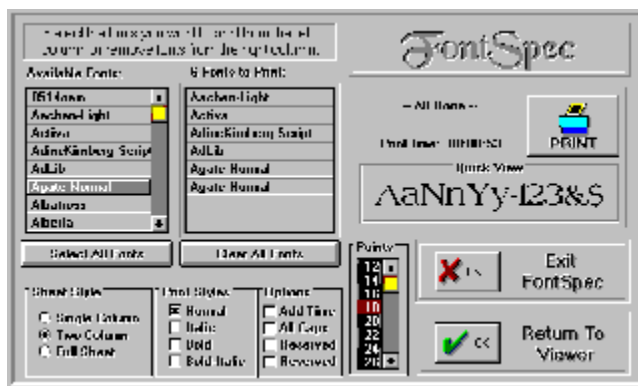

The font metrics are displayed using the labeled pushbutton, adjacent to the printer icon which takes you to the font printing module. Sample sheets are available in single, dual column, or full sheet. All are positioned to allow a left margin for notebook holes and are **very attractive, dated, page numbered, and allow for custom headers and footers**. Font sample size is selectable, and you can choose to print fonts in any or all of regular, bold, italic and bold italic variations if they are available. All in all **FNTSPC32.ZIP** (98K) is a **very professional looking and performing** program which can be registered for a very reasonable **\$19.00**.

**WIN PIM 3D**  
GL = Great Looking



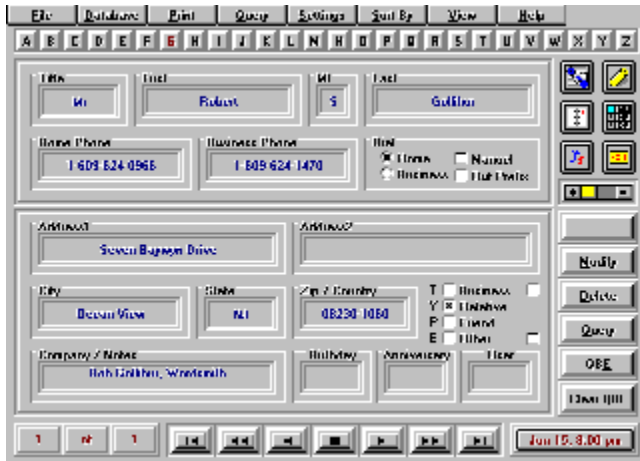

Wolly reviewed a video database program from GL Software in a prior issue of WOLRS. Author Gene Lucio specializes in **3-D look databases**, and Win Pim is no exception. Unfortunately, this is a **demo program** which only allows for modification of the **five records** included for exercise purposes. The program is very pretty and has some nice features, most of what you might expect from a **Personal Information Manager**: Dialer, beautiful pop-up appointment calendar, full font choice and color selections, limited reports (and limited mostly to dot-matrix output), Query by Example, and even a **doodle pad** to bring up while you're on the phone. Start-up of the program will bring any reminders to your immediate attention. The alphabetical rolodex-type keys allow retrieval of the records with great ease. **WINPIM11.ZIP** (396K) deserves some attention if you're in the market, though I suppose I'd get bored trying to give it sufficient exercise being allowed only five records with which to play. Be warned, also, that the program is very **resource-hungry**. It bombed on Wolly's 4 meg 386-25 and slurped up much of his 16 meg 486-33's available stuff (love that technical talk, don't you?). Perhaps the reasonable **\$15.00** registration will encourage you to give it an audition.



## Wolly's Shareware Frowns

Wolly hates to be a nudge (alright, maybe he *likes* being a nudge), but authors, please don't cripple your software so it limps instead of runs. You may think you're *encouraging* registration, but you may, in fact, be *discouraging* it!



Wolly



Click for Table Of Contents



## Tami Talks WPWin 5.2

### *Working Smarter*

By Tami Brydone-Jack

In this column, I want to share some of the tips and tricks that I've found for working smarter in WPWin 5.2. For over five years, I have used WordPerfect, (in its various versions, both DOS and Windows), on a daily basis, on the job. I not only train people in efficient use, I am a user myself. I will try to cover different topics that will be of use in the workplace. I also invite questions and comments to me on the Main Board at Windows OnLine. If I receive questions, I will answer those in forthcoming articles. For this first effort, I will cover a time-saver that has proven itself very useful to me in my work button bars and the ruler.

Button bars can be a great time-saver in automating WordPerfect's functions. As you may know, in version 5.2, positioning the mouse over the button bar and clicking the right mouse button will bring up the list of all loaded button bars which makes for quick and easy changes. I create my own custom button bars for various functions and name them according to those functions. For instance, I work in a law office, and I have to create many boiler-plate court documents. I have made these documents into keyboard merge files which I call up by a macro. These macros are all called up by one button bar, my "Pleading" bar. When I need to create a court document, I simply position the mouse over my button bar, click the right mouse button and select "Pleading." My default bar is now replaced with my "Pleading" bar and I can create these documents with very few keystrokes. You can create (or edit) your own custom button bars quite easily by choosing "View" and then choosing "Button Bars." To remove a button from the bar, simply drag it (with the mouse) off of the bar area onto the text area. To add a new button, choose the function that you want to add. If you want to add a macro to the bar, choose "Add Macro" and then select the macro you wish to add. For simplicity sake, when creating button bars, or editing them, keep all similar commands together. For example, all file functions, such as Open, Close, Save As, Print, Select Printer, etc. should be grouped together. Organize the bar in a way that makes sense for you.

When creating (or editing) button bars, you can choose to have text, pictures, or both on the buttons. I have found that by choosing text only, and having the bar situated on the left side of the screen I can have much larger button bars on the screen with no scrolling. If you have to

scroll through the bar, how much time are you really saving? Not much. Have your bar located on the side of the document, either left or right as you prefer, and have each bar show text only. This way, the buttons can stack up onto one another, instead of being laid side to side. Keep the size of your bars equal to the size of the screen to prevent scrolling, and create as many as you need to do the job efficiently. Your default button bar should have your most used functions on it, such as Open, Save As, Print, Search, Replace, Speller, Thesaurus, Grammatick, etc. Think about those functions you use most often, and make sure they're on your default bar. This will ensure that the button bar feature works for YOU.

Another great time-saver is the ruler. Again, this is chosen in the "View" section. Having the ruler visible gives you instant access to margin changes, tab settings, column layout, table layout, fonts, etc. Using the Windows printer driver instead of the WordPerfect driver will give you access to your TrueType and ATM font collections. Then, add the fonts that you use the most to the ruler. To change your margin and tab settings, simply drag the markers to their new positions. This also works for table and column layouts. Tables and columns can be easily created with the ruler by clicking those buttons and selecting the number of columns (Newspaper columns only), or the size of the table. Line-spacing can also be changed instantly from the ruler, instead of having to go through the Layout menu, simply click the line-spacing button and change the spacing.

By using button bars and the ruler, even a novice WordPerfect user can be up and running like a pro in no time. Is everyone convinced?

Once again, if you have a question about WPWin 5.2, please write me a message on the Main Board at Windows OnLine, and I will answer them in forthcoming articles.

Brought to you by:  
*Tami Brydone-Jack*



[\(Click Here\)](#)



Click for Table Of Contents



## Tape Backup

Paranoia is a mind set most people acquire quite quickly when working with computers. Although we may learn to live with this abnormal condition, very few experienced computer users ever really trust these electronic beasts. In fact, as a friend once told me when I started working with these machines, the three key words to remember when working with any computer are: **BACKUP, BACKUP, and BACKUP**. This friend has actually redefined paranoia about his data to an art form. He keeps at least four complete backups of his system at all times and religiously makes a backup of his working files two times a day. I'm not quite as paranoid as my friend, I also keep four complete backups but I only do a backup of modified files once every day. You might wonder why I keep all these backups. Well, if you've ever seen the message: *Not ready reading drive C, Abort, Retry, Fail* or something similar, you'll instantly know why.

Now, you could make your backups on floppy disks, but if you have a hard drive with more than 40 Mb capacity, this could take a while. In fact I keep two sets of my system backups on floppies. One set on 5.25" disks and one on 3.50" disks. I only update these monthly. My main backups are on tape. I keep two complete backups on tape and a series of daily backup tapes. This process allows me to keep everything current and should everything go south, the most I've lost is one day's work. You may not be as paranoid as I am but you should still keep a fresh copy of everything on your system. The easiest way to do this is with a tape backup system. For my money, the best tape backup system on the market today is the *Colorado Memory System's Jumbo 250*.

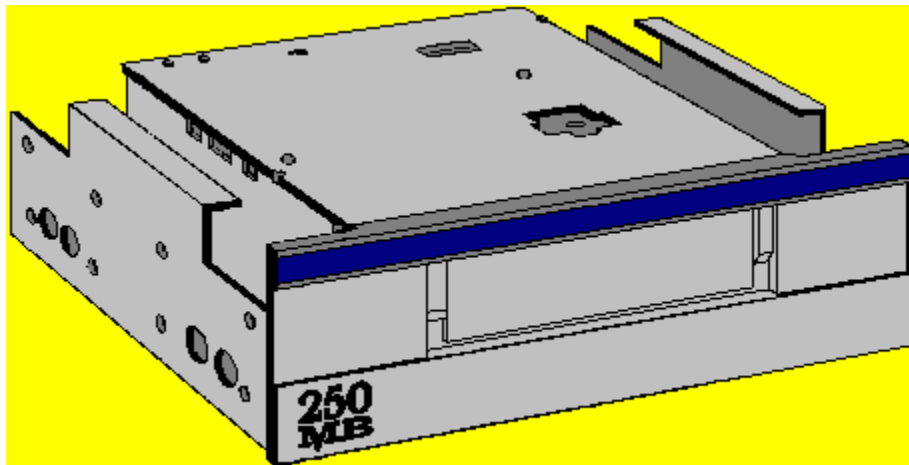

This system is both affordable and reliable. Though your requirements may differ, I like the *Jumbo 250* internal drive. This unit slides right into one of your floppy drive bays and may be connected to your floppy controller or connected to your system with one of the several cards available for the drive. An external version of this tape drive is also available if you don't have an empty drive bay. The tape drive comes with a copy of the Colorado Memory System's DOS software. This software is more than adequate and will perform all your tape backups admirably. But, if you would like to run you backups through windows you might want to take a look at the *Colorado Backup for Windows* program that has just been released.

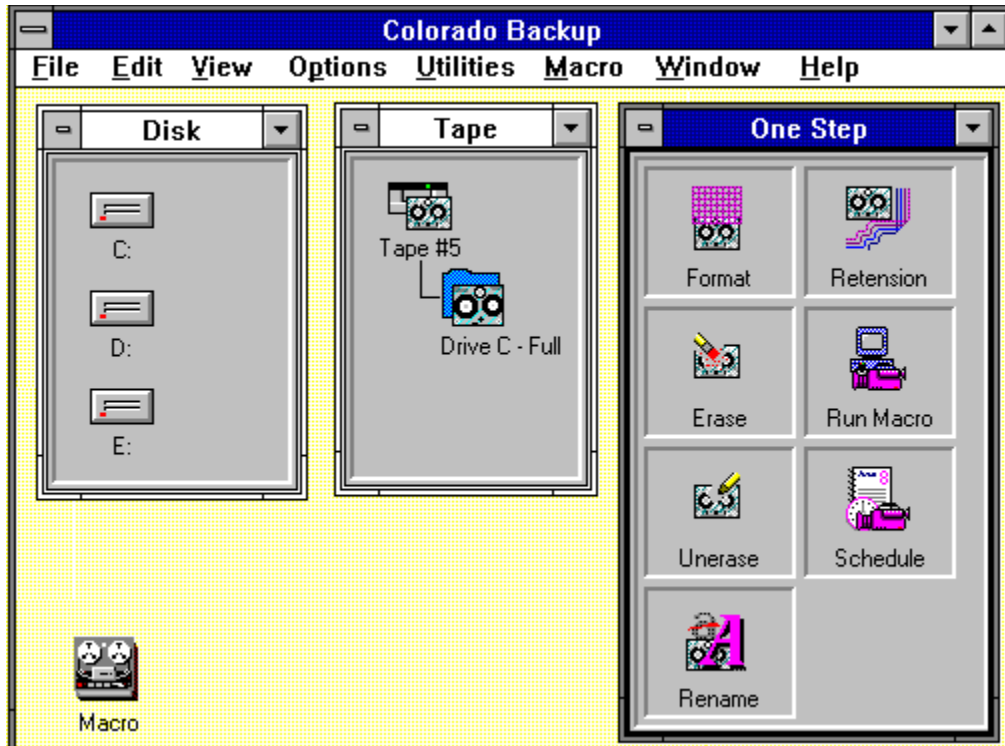

The *Colorado Backup for Windows* program is a worthy addition to the CMS line of tape products. This program not only makes backups easy, but *FAST* as well. The program makes extensive use of drag-and-drop. In fact all commands for the program are started by dragging and dropping the various elements. The program consists of a main window that contain a series of smaller windows. The window on the left shows all your hard drives, the center window shows the tape directory, and the window to the right is the One Step command window.

To use the program simply drag and drop the icons. For example, to format a tape, simply drag the tape icon to the One Step window and drop it in the *Format* box. Likewise to erase a tape, drag the tape icon to the *Erase* box and drop it. Each of the other functions listed in the One Step box are performed the same way. To make a tape backup, click on the hard drive icon and drag it over to the tape icon and drop it. The program then displays a window for you to set your backup parameters and to name the backup volume. Once this is complete, the program automatically performs the backup. Restoring files from the tape to the hard drive is just the reverse. That is, first click on the tape volume icon and drag it to the specific hard drive icon

and then drop it. You are then presented with a window listing the restore options. If you wish to restore selected files a directory of the volume appears to select the specific file to restore.

The program is exceptionally fast. To erase a tape, for example, it takes 4-8 seconds. A typical backup for a hard drive with 80 Mb will take approximately 13 to 16 minutes. The program also has a macro and scheduling options. So, should you desire to perform a backup in a specific way, or order, you can easily create your own macro to do the operation automatically. Sample macros for both a total backup and a daily backup are also included with the program and can be setup automatically during the installation of the program. The scheduling feature allows you to set the specific days and time for a backup. The backup will then run automatically at the scheduled time. Here all you'll need to remember is to keep a tape in the drive.

In addition to working as an excellent backup system, my CMS *Jumbo 250* and the *Colorado Backup for Windows* program also allows me to archive seldom used programs and files. Rather than copying these programs and files to floppies, I simply select the *MOVE* option instead of *COPY* in the backup option. The program then moves the files off the hard drive on to my archive tape. This allows me to open up space on my hard drive, yet still have the programs available should I need to put them back on the hard drive. Then rather than going through a complete installation routine, I simply restore the programs to the hard drive.

The *Colorado Backup for Windows* program may be used with either the CMS Jumbo 120 or Jumbo 250 tape drives and will automatically store the files in either the QIC-40 or QIC-80 formats, depending on the type of drive you have. While even this hardware/software combination will not make performing backups fun, it will make your backup operations go much faster and will greatly simplify the way you do your backups. You can find the Jumbo Tape Drives at your favorite computer store. If they do not have the *Colorado Backup for Windows* program you can order it directly from CMS at the address below.

*Colorado Backup for Windows 1.01* (Retail cost: \$59.00)

Colorado Memory Systems  
800 Taft Avenue  
Loveland, CO 80537

Brought to you by:

*Ed Hoffman*  
Staff Writer



Click for Table Of Contents





*Hoffman & Associates*

*2417 Ranch Lane Colorado Springs, CO 80918*

*Telephone: (719) 599-8823 FAX: (719) 260-1467*

*Edward G. Hoffman, Ph.D., CMfgE, CAMS*



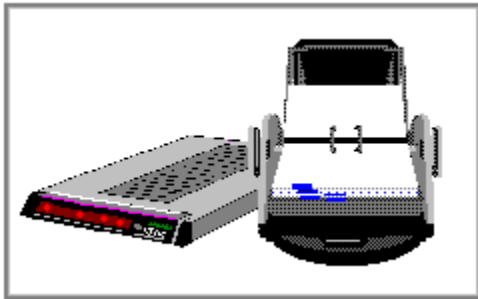

## MicroPhone Pro for Windows

Reviewed by Rich Young

Windows communications packages are starting to pop up all over these days, but Software Ventures has had their foot in the door for quite awhile now. Their most ambitious release to date is MicroPhone Pro for Windows, the first communications software to integrate fax, multimedia support and interactive communication. MicroPhone Pro's powerful scripting language coupled with support for the Windows 3.1 environment, lets you send and fax data anywhere simply by dragging and dropping.

The MicroPhone Pro software integrates WinFax Lite send and receive fax software from Delrina Technology, Inc., allowing MicroPhone scripting commands to entirely automate fax operations. What was once a four or five step process --choose a fax program and driver, select a document, select a destination, print to fax, etc. --becomes a one step drag and drop. You simply drop files on customizable fax icons, set up to broadcast faxes to one address or a 100 person distribution list, instantly or at selected times. Received faxes can be viewed and printed just as easily.

By fully supporting the MPC standard for multimedia, MicroPhone Pro for Windows lets you play and send sounds from various sources, including CD-ROM and MIDI files, play multimedia movies, attach audio greetings to your electronic mail, send multimedia files to remote computers, and, through scripting, control a multimedia presentation.

I was impressed with MicroPhone Pro's support for Windows 3.1 features such as drag and drop, True Type fonts and multimedia support. In addition, MicroPhone Pro includes these new features:



- \* **Icon Bar.** A field, below the MicroPhone Pro menu bar, that contains user-customizable script buttons, which can be identified with text, color icons or both. Clicking a button or

dropping a document on it launches the script it represents. For example, I might prepare a script that automatically uploads my finished articles to my editor at Windows OnLine. Giving my script a button automatically places it on the Icon Bar. Then, whenever a document is dragged and dropped on the icon, it is automatically uploaded.



- \* **Status Line.** A field at the bottom of the application window that provides updates on modem status (even if the hardware is internal), error messages, user-definable messages, and descriptions of menu functions.

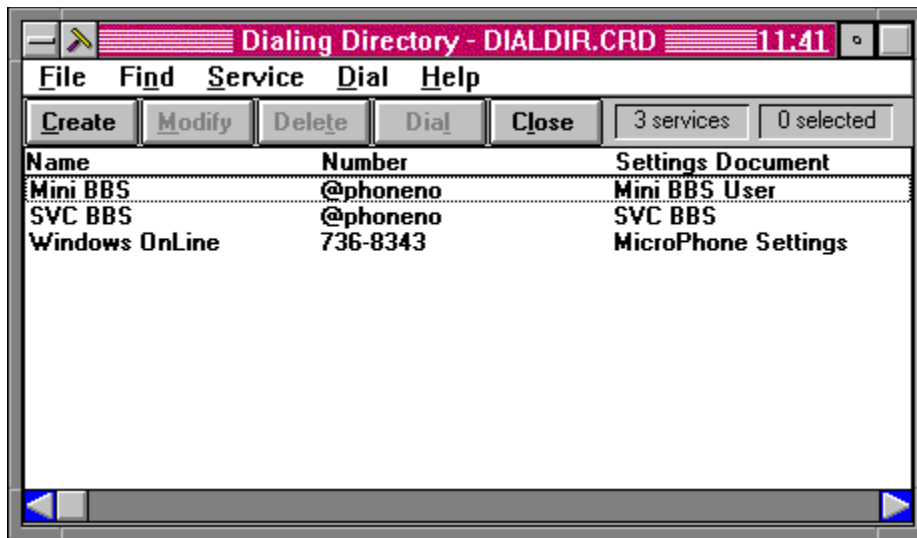

- \* **Dialing Directory.** An online phone book, which automates dialing, redialing and logging on to services and bulletin boards.

MicroPhone Pro lets you send electronic mail, access and retrieve data from information services and corporate databases, perform online research and conduct interoffice data transfers. MicroPhone Pro makes access to remote computers simple and intuitive, through full-featured scripting and graphical user interface design tools. Creating simple scripts is quick and easy, through a built-in script editor with more than 200 prewritten commands and functions to choose from, and Watch Me, an automatic script recorder. I did find that doing any advanced scripting requires much more knowledge than the casual user will possess, as is the case with any powerful scripting language.

MicroPhone Pro also features:

- \* Complete implementation of Dynamic Data Exchange (DDE), allowing MicroPhone to act as both DDE server and client.
- \* Multiple Document Interface support, allowing multiple sessions to run simultaneously.

- \* Multitasking, permitting several applications to run at once, even during file transfers.
- \* ZMODEM protocol support, for the fastest and most reliable transfer speeds.
- \* Network support, including Novell, Net BIOS, ComBIOS, DOS devices and others.
- \* Pre-written log-on scripts to major information services.

## In Conclusion

I found MicroPhone Pro for Windows to be a worthy communications package. It has a full set of features and should serve the needs of most users. I did find the documentation lacking in several key ways. First I found it vague, and badly organized. I also found it hard to understand in most respects. The novice may have major problems with the documentation inadequacies. I like the integrated fax and multimedia support and I see this as the wave of the future. Software Ventures has a great product here and I look forward to seeing how this product develops in the future.

For more information, contact:

**Software Ventures Corporation**  
**2907 Claremont Avenue**  
**Berkeley, CA 94705**  
**(510) 644-3232**  
**(510) 848-0885 FAX**



Brought to you by

(Click)

**Rich Young**  
**Staff Writer**  
**Windows OnLine**

  
Click for Table Of Contents



Written By:

**Rich Young**



**2103 Hillside Ave**

**Walnut Creek, CA 94596**

**(510) 736-8343 - BBS - Conference 4**



©1993 All Rights Reserved



Once upon a time, in the dark and dank days before personal computers ruled the world, when you wanted information you went to a file cabinet, then a drawer, and then a file. Usually, there was an English description that you could understand, and all the other documents, drawings, correspondence, etc., were in that one file section or drawer.

Today's marvelous world of computers confuses us with monikers like TISCDR2.DOC, MEMPAS-2.SAM and similarly cryptic names, spread across megs of hard disk space. Sure, those DOS filenames are meaningful when you create them, but short-term memory fades and six months later you wish for a Personal Computer Rosetta Stone.

If you are project-driven as I am, trying to keep several balls in the air like a bad Vegas act, Golden Retriever may be a solution to consider. No matter what application you created the file with, and no matter where it lurks within your megs of drive space, all the related files can be in the same place. It harkens back to the early days of organized chaos in file cabinetry. And, unlike that assistant you had in the past, Golden Retriever knows the alphabet.

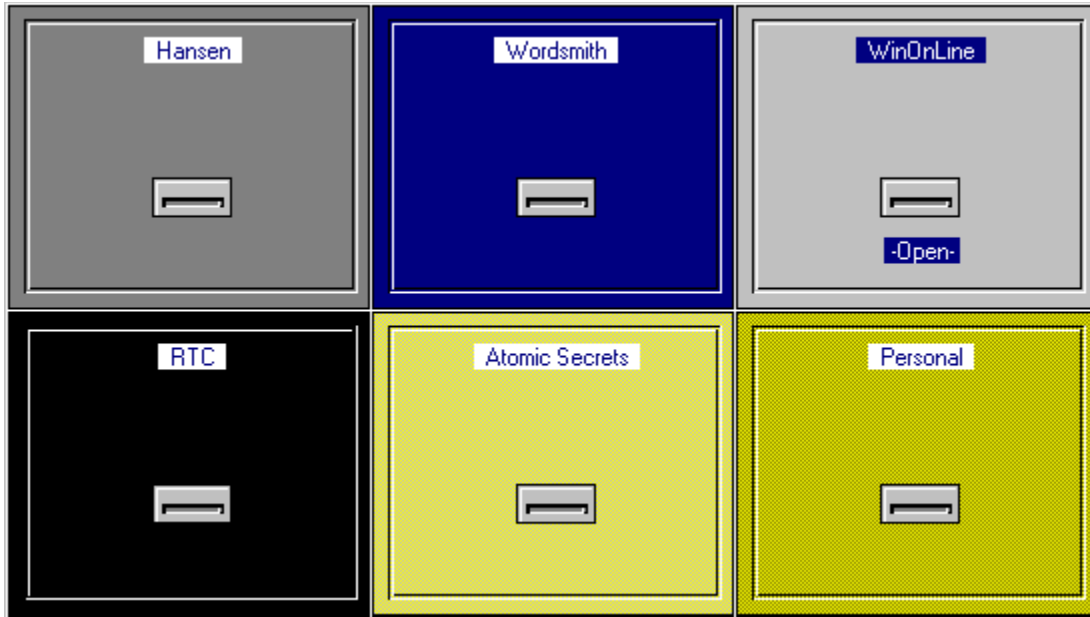

Golden Retriever attempts to make the transition back to conventional filing methods as simple as possible. Import features can bring a type of file in for "filing" within the Golden Retriever file drawers and folders. Those folders are much like the familiar hanging type residing in your physical file cabinet, only you can read the written description on these, and they are definitely in alphabetical order. Folders may be added with ease.



You could feel at first that the program a bit "cutesy" with its icons and some terminology carrying the dog metaphor a bit far, but the purpose of most are clear and intuitive. There are very bold and purposeful screens for nearly everything, each with sets of icons and references that will make your navigation of the program easier.

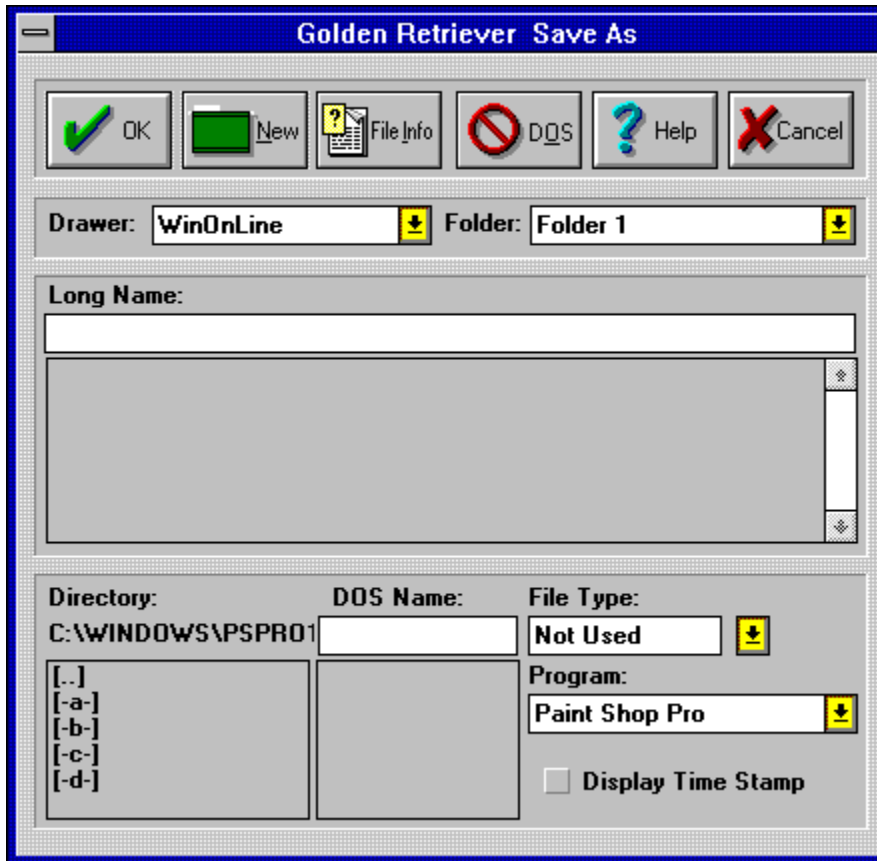

There have been other attempts at this very worthy concept, but their failing is always in the duality of troublesome additional "saves", first with DOS, and then a second step to index the file within the utility's database. Golden Retriever's method to eliminate this additional step is to intercept the program's save with its own. Unlike Sherlock, a similar program we've reviewed (see WOLR69.ZIP, January 14, 1993), this intercept works with most programs and does not require a specific driver for most programs. Golden Retriever even provides a work-around for those programs that do not use standard Windows open/save dialogs. I initiated an open file function using over two dozen assorted popular and obscure commercial and shareware word processing, graphics, financial, utility and other programs, all of which triggered the Golden Retriever open intercept as it should. The sudden appearance of the pop up is most convenient if you wish to organize all your files using Golden Retriever; it's an inconvenience that can quickly be dismissed with a click if the file is superfluous or temporary so you can use the usual save procedure.

This brings to mind another well thought out feature of the program. You may locate and then delete files through Golden Retriever, again avoiding the duality of deletion of the actual file and the "database" entry. Another trait to be admired is the ability of the program to generate multiple generations of a file as you edit it, leaving a sometimes desired audit trail of document revisions complete with time and date stamps. Multiple "aliases" are supported, so you can reference the same file from different folders if need be. DOS applications can also be integrated in addition to Windows.

The software further makes its own "desk" available to be configured, so you may launch other applications from within the program. Keep in mind, however, that Golden Retriever can remain iconized and stay in the background as you work, coming to life only when you open or save files. Some systems totally make you change the way in which you work to take advantage of longer file names, such as HP's New Wave. Golden Retriever will also demand some changes to your methodology, but its logic is easily followed and does not substantially change the manner in which you operate.

Setup is quick and automated and can be reactivated to include additional programs you may add to your drive. Above Software responsibly provides an uninstall feature to purge the program from your system if for some reason you feel it's not for you.

Earlier versions of Golden Retriever received some lukewarm reviews. Version 2.0b addresses many of those caveats and now requires less overhead, only about five percent of system resources.

I recommend that anyone who finds the sound of "old fashioned" organization appealing, and not "old" in the negative sense, check out Golden Retriever for this trait and many other helpful features. When your projects span several programs and file types, perhaps generations of revisions, this type of structure is most appealing and may help preserve your sanity and improve your productivity.

List price: \$99.00

*for further information contact:*

Above Software  
2698 White Road, Suite 200  
Irvine, California 92714  
714-851-2283



**Bob Gollihur**



## Staff Writer



[Click for Table Of Contents](#)

**Bob Gollhur, Wordsmith**

Seven Bayview Drive, Ocean View, NJ 08230 609-624-0966



## ATI Graphics Ultra + Video Accelerator Card

One of the first things you learn when switching from DOS applications to Windows is there is a definite difference in speed. Though Windows applications offer a WYSIWYG (What you see is what you get) display, you will often pay a price in overall speed to get the better screen appearance. To compensate for this speed problem a variety of different types of video systems have been developed. However, in most cases, each of these solutions have simply added some capabilities at the expense of others. Today, the best type of video card you can get for Windows is a graphic accelerator card. These video cards offer increased performance for both text and graphic as well as a wide range of colors. But, here again, the trade off with these accelerated video cards is cost. Quite often these cards may be more expensive than some monitors. But, to get the most from their systems, many users have paid these mega prices to maximize their Windows performance. Today, with the *ATI Graphics Ultra +* video accelerator, the correlation between high prices and high performance may very well be a thing of the past.

Resolution	Colors	1Mb	2Mb
1280 x 1024	256		○
1280 x 1024	16		○
1024 x 768	65,000		■
1024 x 768	256	■	■
800 x 600	16.7M		■
800 x 600	65,000	■	■
800 x 600	256	■	■
640 x 480	16.7M	■	■
640 x 480	65,000	■	■
640 x 480	256	■	■

○ Interlaced

The *ATI Graphics Ultra +* video accelerator card is one piece of hardware I plan on keeping as part of my system. This accelerator card offers both high performance and functionality at a price that will allow you to upgrade your system without applying for a bank loan. In fact at \$249.00 for the 1Mb card and \$299.00 for the 2Mb card, these cards are almost half the price of comparable cards on the market. (The 1Mb card is being discontinued soon, so if you want one you'd better act quickly.) As a member of the highly rated ATI family of thoroughbred video cards, the *Graphics Ultra +* carries a five-year warranty, so should something go wrong with your card, it will be repaired or replaced free for up to five years.

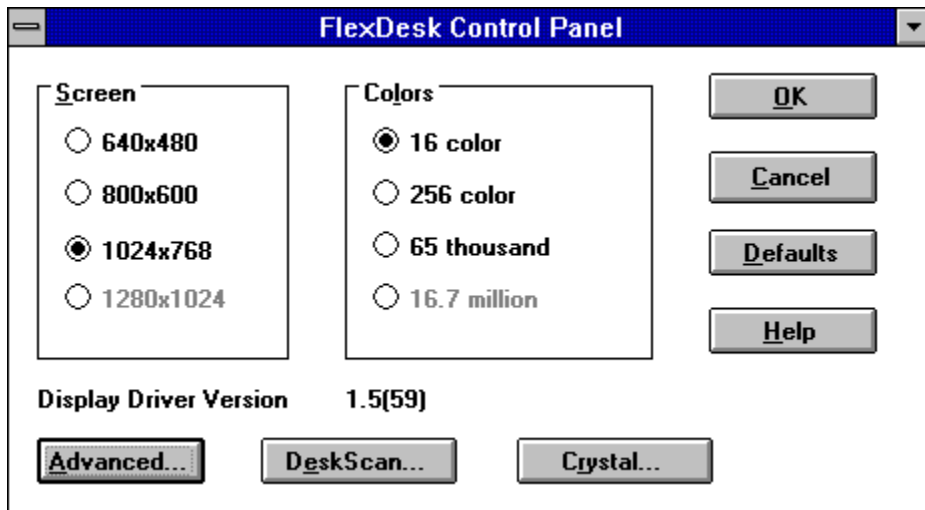

The video range of the *ATI Graphics Ultra +* card is also quite impressive. Depending on your monitor the card can display up to 16.7 million colors in resolutions from 640 x 480 to 1280 x 1040. The *ATI mach32 Graphics Accelerator®* includes BitBlt, line draw, polygon fill, hardware cursor and linear memory addressing functions plus 64 bit architecture. The drivers furnished with the card support virtually all applications. One unique addition for the Windows application is the *FlexDesk®* and *DeskScan®* controls. The *FlexDesk* controls the resolution, color, font, and desktop size from a single window. The *DeskScan* is a virtual desktop option for Windows that allows you to pan and zoom around your desktop. The drivers also include the *ATI Crystal* fonts for higher resolutions. This driver makes small fonts very legible by showing laser-quality fonts on your screen.

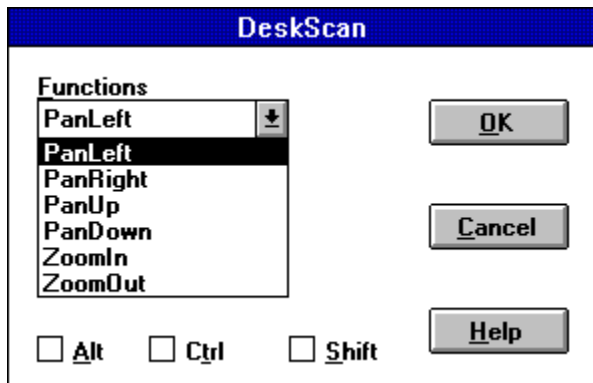

In addition to the standard Windows programs, the card also supports multimedia acceleration. So, if your running multimedia and video (AVI®) applications the *ATI Graphics Ultra +* card will also produce better images on your screen by eliminating color conflicts. A new set of drivers will soon be released to further enhance and support these applications.

An added feature of the card is a built-in mouse port to attach the three-button mouse that is included with the card. So, if you are looking for a new mouse, you'll get one free with the *ATI Graphics Ultra +* card. This built-in mouse port not only makes connecting the mouse

easier, but will free up one of your communications ports if you have a serial mouse or will let you reclaim a card slot if you have a bus mouse installed.

The *ATI Graphics Ultra +* video accelerator is one piece of hardware that is well worth the price. Whether you're running Windows, OS/2, UNIX, CAD or Multimedia applications, this is one card that can make your computing life a bit easier.

### *ATI Graphics Ultra + Video Accelerator Card*

(Retail cost: \$239.00 - 1Mb and \$299.00 2Mb)

ATI Technologies Inc.  
33 Commerce Valley Drive, East  
Thornhill, Ontario  
Canada L3T 7N6

Brought to you by:

*Ed Hoffman*

Staff Writer



[Click for Table Of Contents](#)

# Sketcher



Sketcher

## Fractal Design Sketcher

Fractal Design Sketcher is a versatile greyscale painting and image enhancing program. Sketcher can be used with either a mouse or stylus and pressure sensitive graphics tablets. Sketcher is easy to learn, with excellent documentation.

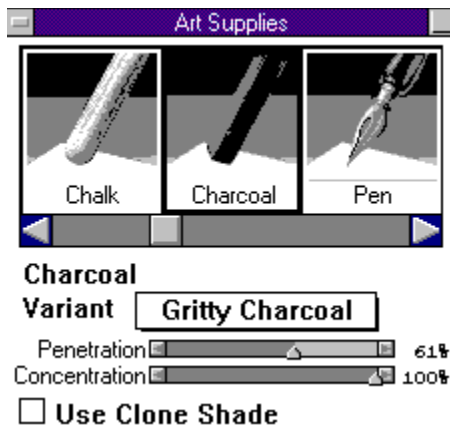

Sketcher's "natural media" brushes, papers, and media mimic those of traditional art supplies. This makes working with Sketcher very much like drawing on paper. When using the stylus, pressing harder makes the line thicker, and when using the mouse, dragging slower has the same effect.

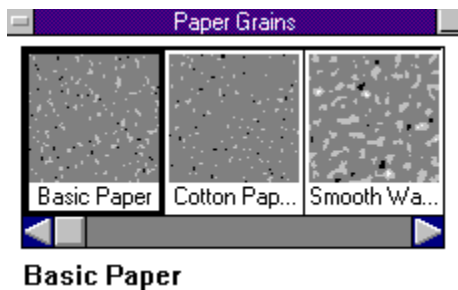

There are quite a few different paper grains to choose from when using Sketcher. This makes for some very interesting effects when painting. The paper grain reacts with the various art media, just as it would if you were actually using these papers and supplies.

A feature that is very exciting to work with is the "cloning" feature. With the cloning feature, an original bit mapped image is "cloned" and can be edited or enhanced in various ways. With "clones" Sketcher also has a tracing paper feature that will redraw the picture using another media. The following examples will show some of the things that can be done with a picture.



This is the original bit mapped image, a greyscale photograph of a lake.



This oil painting effect was achieved by cloning the picture, and from the clone, choosing the "tracing paper" option. After "tracing paper" was turned on, the image was then redrawn with the "hairy brush" and then the 3D brush stroke effect was applied.



This picture was done by cloning the original image, turning on "tracing paper," recording a brush stroke, and replaying it with the sharp chalk tool, to render a chalk drawing.



Another interesting feature is the frisket feature. A frisket is a template. To create this drawing, I created a text frisket, (which is the only way text can be used in Sketcher), feathered the edge and filled it with the black spray can. Then, I moved the frisket slightly, sharpened the edges, filled it with 40% grey, and added a paper texture effect only to the grey-filled frisket. Friskets do not have to be text, they can be any shape you wish. Friskets may not only be moved, they can be resized as well, and you can have multiple friskets in a given drawing.

Sketcher is very versatile, and although it is geared toward artists, even non-artists can create professional artwork with relative ease. Although I wouldn't normally mention the packaging, Sketcher's package is in keeping with its "natural media" feel, in that it comes in a very attractive pencil box.

Minimum requirements to run Sketcher are a 386SX or higher IBM PC or compatible, black and white monitor (will run on a color monitor, but it's not a requirement), VGA or better, hard disk 4 MB RAM, and Windows 3.0 or later. Also supported, though not required, are a Wacom, CalComp or Kurta pressure-sensitive graphics tablet and co-processor. In my opinion, a faster machine with more RAM and a co-processor would greatly improve speed and performance. I found that with Sketcher loaded on my 386/40 with 4MB, it ran slowly and I had problems running other applications at the same time.

For its \$99.00 list price, Sketcher is a great bargain. Contact Fractal Design at:

**Fractal Design Corporation**  
**335 Spreckels Drive, Suite F**  
**Aptos, California 95003**

Brought to you by:  
*Tami Brydone-Jack*





[\(Click Here\)](#)



Click for Table Of Contents





## Alki MasterWord

Word for Windows is one of today's most powerful word processing programs. But, quite often, it isn't until third party vendors develop auxiliary programs that the capabilities of even the best software are fully explored. Such is the case with Word for Windows and the *MasterWord* program. *MasterWord* integrates seamlessly with Word for Windows and provides a wealth of refinements and additions to the basic Word program.



The first addition you'll notice with *MasterWord* is an additional toolbar. This toolbar allows you to use a variety of pre-defined commands as well as adding your own macros or commands. This additional toolbar floats and may be positioned directly over the normal toolbar or anywhere else on your screen. This toolbar may also be positioned horizontally or vertically. The first button on this toolbar serves a variety of purposes. Clicking on this button shows you the date, time, number of words, template name, elapsed time, or a short reminder. The next button hides or displays the custom toolbar. The next group of four buttons access the *MasterWord* tools. These include a Nickname feature that allows you to access shortcut keys to run macros or commands with a two or three letter code. The last button in this group performs the same function with your style templates. The *MasterWord* Template Selector and *MasterWord* Manager are also selected with these buttons. These utilities allow you easy access and control of your templates, by permitting you to freely move and copy macros, styles, glossary entries from one document to another.



The next button is for the *MasterWord* Help Index. I must admit that this feature ranked very high on my Ho-Hum scale until I used it for the first time. Rather than the usual minimal assortment of often obvious information, the *MasterWord* help system is a genuine jewel. Not only are answers to the more routine questions completely addressed, but a wide range of more advanced topics are included as well. In addition, quite a few very useful points and procedures for both the basic Word for Windows program and *MasterWord* are also included and well explained. The help system may also be set to match your level of proficiency with Word for Windows. The default is Normal, but there are also *Beginner*, *Intermediate*, and *Advanced* levels as well. There is even a help level for *Kids*. (I found this level quite instructive and I plan on reading this section quite often.) The help system is also completely cross-referenced and a wide range of related topics are only a mouse click away.

The *MasterWord* program comes furnished with 20 sample CustomBar sets that you may use as they are or customize to suit your own requirements. A sizable assortment of images (over 500) are also furnished for your customized tool bars. If you don't really care for the images provided, there is also a button editor included in the program. With this editor you can either modify or create you own images for both the button bars or for the Template Selector. You may even wish to use the editor to add a bit of color to the standard Word for Windows toolbar. The program also includes over 50 useful macros. You can use these macros as they are or as a sample for writing your own macros.

Another unique addition to the *MasterWord* program are a series of additional file commands. For example, the File Open command shows the file date, size, type, of any file and the summary information for Word for Windows files. The File New and Save As are also improved. Four new entries are also added to the File Menu to make Word for Windows a bit easier to use. These commands include: File Close All, File Delete, File Rename and File Directory.

The *MasterWord* program is truly a useful addition to the Word for Windows program. The tools and utilities included with the program are well thought out and actually quite beneficial. A demonstration disk showing the major features of the program is also available from Alki Software. Members of Windows OnLine can find this demo as ALKIDEMO.ZIP in Directory #150 (Windows - New Uploads). Anyone who uses Word for Windows, from the novice to the experienced power user will find *MasterWord* offers a range of beneficial and time saving features. I'm not sure, but I think the combination of Word for Windows and *MasterWord* might be causing some sleepless nights at the other word processing houses.

*Alki MasterWord* (Retail price: \$59.95)

Alki Software Corporation  
300 Queene Anne Ave. North, #410  
Seattle, WA 98109-9803

Brought to you by:

*Ed Hoffman*

Staff Writer



[Click for Table Of Contents](#)

