



INTERNATIONAL TELECOMMUNICATION UNION

ITU-T

TELECOMMUNICATION
STANDARDIZATION SECTOR
OF ITU

I.520

(03/93)

**INTEGRATED SERVICES DIGITAL
NETWORK (ISDN)
INTERNETWORK INTERFACES**

**GENERAL ARRANGEMENTS FOR NETWORK
INTERWORKING BETWEEN ISDNs**

ITU-T Recommendation I.520

(Previously "CCITT Recommendation")

FOREWORD

The ITU Telecommunication Standardization Sector (ITU-T) is a permanent organ of the International Telecommunication Union. The ITU-T is responsible for studying technical, operating and tariff questions and issuing Recommendations on them with a view to standardizing telecommunications on a worldwide basis.

The World Telecommunication Standardization Conference (WTSC), which meets every four years, established the topics for study by the ITU-T Study Groups which, in their turn, produce Recommendations on these topics.

ITU-T Recommendation I.520 was revised by the ITU-T Study Group XVIII (1988-1993) and was approved by the WTSC (Helsinki, March 1-12, 1993).

NOTES

1 As a consequence of a reform process within the International Telecommunication Union (ITU), the CCITT ceased to exist as of 28 February 1993. In its place, the ITU Telecommunication Standardization Sector (ITU-T) was created as of 1 March 1993. Similarly, in this reform process, the CCIR and the IFRB have been replaced by the Radiocommunication Sector.

In order not to delay publication of this Recommendation, no change has been made in the text to references containing the acronyms "CCITT, CCIR or IFRB" or their associated entities such as Plenary Assembly, Secretariat, etc. Future editions of this Recommendation will contain the proper terminology related to the new ITU structure.

2 In this Recommendation, the expression "Administration" is used for conciseness to indicate both a telecommunication administration and a recognized operating agency.

© ITU 1993

All rights reserved. No part of this publication may be reproduced or utilized in any form or by any means, electronic or mechanical, including photocopying and microfilm, without permission in writing from the ITU.

CONTENTS

	<i>Page</i>
1 Introduction.....	1
2 Scope.....	1
3 Required information and information handling	1
4 Description of ISDN-ISDN interworking configurations	4
4.1 ISDN-ISDN interface where circuit mode bearer services are provided by both ISDNs.....	4
4.2 ISDN-ISDN Interface where both ISDNs provide X.31 case B based packet mode bearer services	4
4.3 ISDN-ISDN interface where a circuit mode bearer service is provided by one ISDN to access either a PSPDN, or a PH and an X.31 case B packet mode bearer service provided by another ISDN	5
4.4 ISDN-ISDN interworking via a transit network.....	5
4.5 ISDN-ISDN interface for additional packet mode bearer services.....	5
4.6 ISDN-ISDN interface where an X.31 case B based packet mode bearer service is provided on one ISDN and an additional packet mode bearer service is requested on another ISDN	6
4.7 ISDN-ISDN interface for circuit mode to additional packet mode service	6
5 Interworking functions.....	7
5.1 Echo control processing and speech processing	7
5.2 Generation of in-band tones and announcements for speech and 3.1 kHz audio bearer services ...	7
5.3 Call negotiation between ISDNs.....	7
5.4 Compatibility checking between end users of different ISDNs	9
6 Functional interworking requirements for data transmission services	9
7 References	10
Appendix I – ISDN connections involving restricted 64 kbit/s transfer capability.....	10
I.1 General	10
I.2 Interworking with ISDNs providing restricted 64 kbit/s	10
1.3 Considerations for terminal designed to operate with restricted 64 kbit/s transfer capability	12

GENERAL ARRANGEMENTS FOR NETWORK INTERWORKING BETWEEN ISDNs

(Melbourne, 1988; amended at Helsinki, 1993)

1 Introduction

The number of ISDNs existing in the world is increasing and more than one ISDN may exist even within a single country. Therefore, ISDN-ISDN network interfaces should be standardized to facilitate the interworking between ISDNs and to extend connectivity world-wide.

2 Scope

The purposes of this Recommendation are

- 1) to identify the general arrangements for ISDN-ISDN interworking, and
- 2) to define the functions and other requirements for the ISDN-ISDN interface.

Recommendation I.324 defines the reference point between two interconnected ISDNs to be the N_x reference point. This Recommendation identifies other Recommendations which should be applied to the N_x reference point and clarifies the functions and requirements for interworking at the N_x reference point.

3 Required information and information handling

Figure 1 illustrates the general configuration for interworking between two ISDNs. The information given in Tables 1, 2 and 3, when required, has to be carried by Signalling System No. 7 (SS No. 7) ISUP and X.75, and is handled at the IWF in one of the following ways:

- i) information is terminated at the IWF and is not transferred to other ISDNs;
- ii) information is interpreted at the IWF and is transferred to other ISDNs;
- iii) information is transferred through the IWF transparently;
- iv) information is newly generated at the IWF.

Tables 1, 2 and 3 also show the classification of information into the above four categories for circuit mode bearer services, circuit mode supplementary services and packet mode bearer services, respectively.

Additional information required specifically for OAM (Operational, Administrative and Maintenance) functions is for further study.

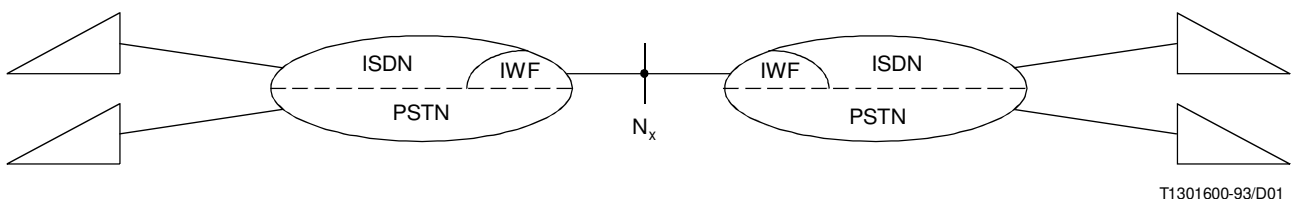

FIGURE 1/I.520

General configuration for interworking between two ISDNs

TABLE 1/I.520

Information required for IWF between ISDNs for circuit mode bearer services

Category	Required information	Rec. Q.931 information element	Rec. Q.763 parameter name
i	First transit network subsequent to IWF	Transit network selection	Transit network selection
ii	Called party number (Note 1)	Called party number/Key pad	Called party number/Subsequent number
	Calling party's category (Note 2) Bearer capability	(Unnecessary) Bearer capability	Calling party's category Transmission medium requirements User service information
	Call indicators (Note 3)	(Unnecessary)	Forward call indicators Backward call indicators
	Use of satellite (Note 4)	(Unnecessary)	Nature of connection indicators
iii (Note 8)	Calling party number	Calling party number	Calling party number
	Subaddress	Subaddress	Access transport
	Calling party's category	(Unnecessary)	Calling party's category
	Terminal compatibility (Note 5)	Low layer compatibility High layer compatibility	Access transport
	User-to-user signalling	User-to-user information element	User-to-user information
	Cause	Cause	Cause indicator
	Charge	(Unnecessary)	Charge information
iv	Cause for interworking	Cause	Cause indicator
	Charging information (Note 6)	(Unnecessary)	Charge information
	Change of services (Note 7)	(Should be defined)	(Should be defined)

NOTES

- 1 For charging use.
- 2 For discrimination of priority call/ordinary call.
- 3 These indicators are used to identify:
 - a) international incoming call,
 - b) available end-to-end signalling system,
 - c) charged call/noncharged call.
- 4 When a satellite circuit is employed for an interworking call at the interworking point, this information is processed at the IWF. If a satellite circuit is not employed for a call, this information is transferred through the IWF transparently.
- 5 There may be cases where the terminal compatibility information is processed (see 5.4).
- 6 This information is used only when access charging is necessary.
- 7 All ISDNs do not necessarily provide identical services (or connection types). When a change of services occurs at the IWF, the network should send the indication for change of services and may solicit acceptance of change of services to a calling user in certain cases (see 5.3.1).
- 8 The information in this category is transferred through the IWF transparently.

TABLE 2/I.520

Information required for IWF between ISDNs for circuit mode supplementary services

Category	Required information	Rec. Q.931 information element	Rec. Q.763 information element
ii	Supplementary service request	Network specific facility Key pad facility Feature activation Feature indication	(Should be defined)
iii	Progress indicator Suspend/Resume indicator	Progress indicator Notification indicator	Access transport Suspend/Resume indicator

TABLE 3/I.520

Information required for IWF between ISDNs for packet mode bearer services (in-band signalling)

Category	Required information	Rec. X.25 information	Rec. X.75 information
i	Transit network identification	ROA selection	Transit network identification
ii	Packet type Logical channel number Called party number Throughput class Window size Packet size Call identifier Transit delay selection User-to-user information	Packet type identifier Logical channel number Called DTE address Throughput class negotiation Flow control parameter negotiation Flow control parameter negotiation (Unnecessary) Transit delay indication/selection Fast select identifier	Packet type identifier Logical channel number Called DTE address Throughput class indication Window size indication Packet size indication Call identifier Transit delay indication Fast select indication
iii	Calling party number Terminal compatibility Subaddress Cause	Calling DTE address (Call user data) Calling address extension Called address extension Diagnostic code	Calling DTE address (Should be defined) Called address extension Calling address extension Diagnostic code
iv	Cause for interworking Charging	(Should be defined) Charging information	(Should be defined) (Should be defined)
NOTE – The relationship between X.25 facilities and ISDN supplementary services is for further study.			

4 Description of ISDN-ISDN interworking configurations

4.1 ISDN-ISDN interface where circuit mode bearer services are provided by both ISDNs

See Figure 2.

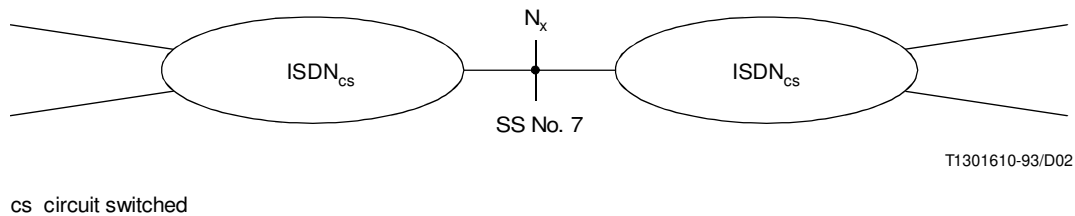

FIGURE 2/I.520
ISDN_{CS} interworking with ISDN_{CS}

4.1.1 Bearer services

Individual bearer service categories are defined in the I.230-Series Recommendations.

Layer 1 interworking specifications are recommended in Recommendation I.511. Layers 2 and 3 in the U-plane are passed transparently.

4.1.2 Supplementary services

4.1.2.1 Other than user-to-user signalling

For supplementary services other than user-to-user signalling, call control information is transferred via Signalling System No. 7 across the N_x reference point. The interface for user information transfer is not different from that of basic bearer services.

4.1.2.2 User-to-user signalling services

There are two methods of transferring user-to-user signalling. One is transfer of user-to-user signalling within Q.931 call control messages which have been mapped into Signalling System No. 7 messages and then are conveyed via the Signalling System No. 7 network. The other is transfer of user-to-user signalling within stand alone USER INFO messages (which have been mapped into Signalling System No. 7 messages and then are conveyed via the Signalling System No. 7 network), or optionally may be transferred via packet handlers (PHs) in some ISDNs. In the case where user-to-user signalling is transferred between packet handlers (PHs) in both ISDNs, the X.75 protocol may be applied to the internetwork interface to transfer user-to-user signalling. In the case where user-to-user signalling is transferred via Signalling System No. 7 networks in both ISDNs or at least in one ISDN, the Signalling System No. 7 protocol should be applied to the internetwork interface for user-to-user signalling.

4.1.3 Signalling System No. 7 for the control of circuit mode services at the N_x reference point

For the control of circuit mode services in the long term, Signalling System No. 7 with ISUP will be used at the N_x reference point.

4.2 ISDN-ISDN Interface where both ISDNs provide X.31 case B based packet mode bearer services

See Figure 3.

The X.75 protocol is used to transfer X.31 based packet mode services at the N_x reference point. Layers 1, 2, and 3 for this interface are specified in Recommendation X.75.

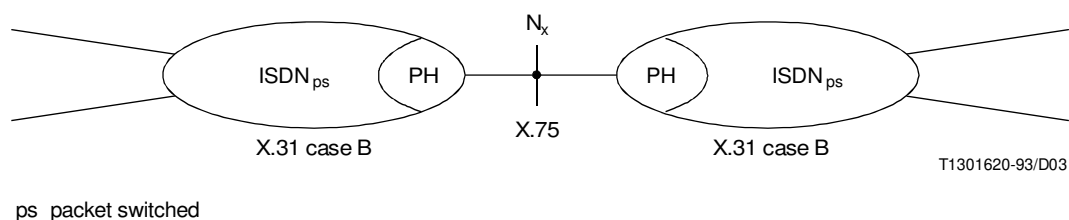

FIGURE 3/I.520
ISDN_{ps} interworking with ISDN_{ps}

4.3 ISDN-ISDN interface where a circuit mode bearer service is provided by one ISDN to access either a PSPDN, or a PH and an X.31 case B packet mode bearer service provided by another ISDN

With this type of interworking, two different configurations are considered, I and II. In configuration I, interworking between the two ISDNs utilizes X.75 interexchange signalling. See Figure 4.

In configuration II, a circuit switched access to the PH in the ISDN_(ps) is provided, and the interworking between the two ISDNs utilizes a Signalling System No. 7 protocol.

This interworking arrangement applies for data transmission services. General arrangements are covered in 6.3/X.320. There are two possibilities:

- i) X.31 case A interworking with X.31 case B. Case A refers to the situation where a transparent circuit switched access to PSPDN is provided by ISDN. Case B refers to the situation where a packet mode bearer service is provided by an ISDN PH.
- ii) ISDN circuit switched access to an ISDN PH (this case may exist if the originating ISDN does not have PH functionality).

Several aspects of interworking for data transmission services as well as their application to other transmission services are for further study.

4.4 ISDN-ISDN interworking via a transit network

ISDN-ISDN interworking via a transit network (see Figure 5) may be a useful configuration in the short term for extending specific ISDN services on an end-to-end basis. Special transmission, switching and signalling capabilities may have to be deployed in the transit network to ensure that the specific ISDN service is available end-to-end.

The detailed interworking functions and interfaces for this configuration are for further study.

4.5 ISDN-ISDN interface for additional packet mode bearer services

For packet mode services that are currently under study, out-band call control signalling is used. The same out-band call control is used for circuit mode services. Two alternatives can be considered for this out-band call control: enhancement of Signalling System No. 7 and enhancement of the D-channel protocol. The choice between the two alternatives is for further study.

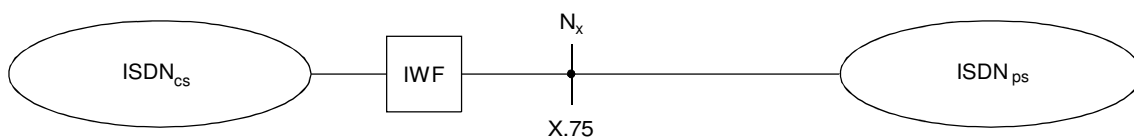

NOTE – The IWF is logically part of the ISDN_{CS}. For further details, see Recommendation X.320.

a) Configuration I: ISDN_{CS} interworking with ISDN_{PS}

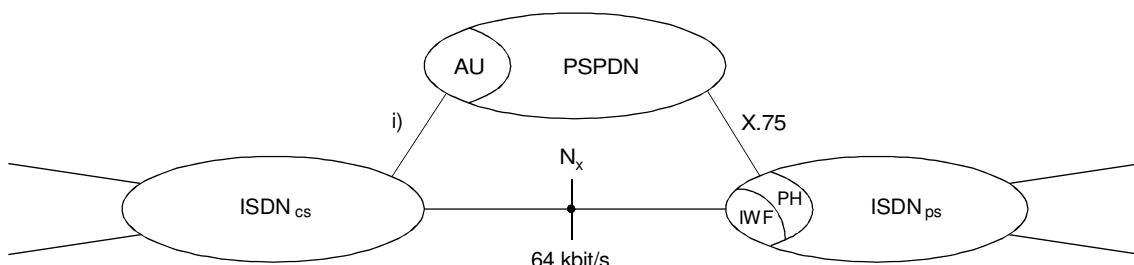

T1301630-93/D04

NOTE – For accessing the PH, the IWF must include access unit (AU) functionality as defined in Recommendation X.31 for the PSPDN.

b) Configuration II: ISDN_{CS} interworking with ISDN_{PS}

FIGURE 4/I.520

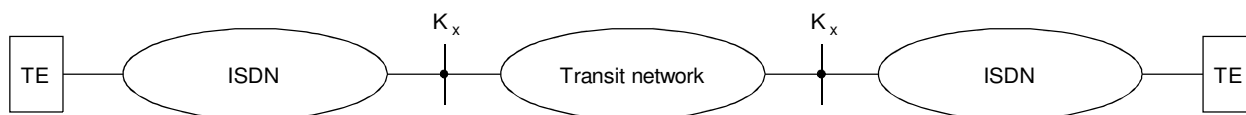

T1301640-93/D05

FIGURE 5/I.520

Interworking of two ISDNs via a transit network

4.6 ISDN-ISDN interface where an X.31 case B based packet mode bearer service is provided on one ISDN and an additional packet mode bearer service is requested on another ISDN

Two alternatives can be considered: the first is based on in-band signalling (X.75), and the second is based on out-band signalling (Signalling System No. 7 or D-channel protocol). The choice between the two alternatives is for further study.

4.7 ISDN-ISDN interface for circuit mode to additional packet mode service

This subclause is for further study.

5 Interworking functions

Interworking functions commonly employed for various types of interworking are described in Recommendation I.510. The interworking functions specific to ISDN-ISDN interworking are described here.

5.1 Echo control processing and speech processing

Table 4 shows the permitted relationship between circuit mode bearer services and various forms of speech processing functionality. These speech processing functions include digital speech interpolation (DSI), low rate encoding (LRE) and digital circuit multiplication (DCM). Depending upon the particular relationship to the circuit mode bearer services, these processing functions are specified as essential, optional, prohibited or functionally disabled.

For a speech, 3.1 kHz audio, or 64 kbit/s unrestricted call within an ISDN, appropriate network control is required to ensure that the relationship shown within Table 4 is realized. An example of this control might be routing (to exclude or include a function) or out-band signalling (to disable a function). Further, it is to be noted that a disabling tone (see Recommendations V.25 and I.530) may be used to functionally remove echo control devices on a 3.1 kHz audio bearer service connection.

For a call which involves communication through different ISDNs, the network information regarding control of these functions needs to be extended across the ISDN-ISDN internetwork interfaces. This information transfer is realized between the exchanges in interworking ISDNs by means of

- 1) the Signalling System No. 7 ISUP bearer capability information element, and
- 2) the use of a disabling tone (see Recommendations V.25 and I.530) by terminals, in the case of a 3.1 kHz audio bearer service.

The control of speech processing functions (DCM, A- μ law conversion, echo control, etc.) by exchanges is

- a) not needed when a disabling tone (see Recommendations V.25 and I.530) is used, in conjunction with the 3.1 kHz audio bearer service by a terminal(s), and
- b) to be implemented using out-band call processes (currently under study) when needed.

The procedures in the case of alternate speech/64 kbit/s unrestricted bearer services, are for further study.

5.2 Generation of in-band tones and announcements for speech and 3.1 kHz audio bearer services

NOTE – This function is also necessary for a call within one ISDN, which does not involve network interworking nor internal ISDN interworking.

5.2.1 Unsuccessful call delivery

The point of call failure (i.e. the point at which the connection cannot proceed further) should generate the appropriate out-band clearing message toward the calling exchange. In response to this message, the calling exchange should send the appropriate out-band message to the calling user. However, for speech and 3.1 kHz audio bearer services, the network must be capable of generating the appropriate in-band tones or announcements. In this case, the clearing message should not be sent prior to the completion of the announcements.

5.2.2 Successful call delivery

For speech and 3.1 kHz audio bearer services, the terminating exchange should generate in-band ring back tone towards the calling user upon successful delivery of the call.

5.3 Call negotiation between ISDNs

There are two aspects of call negotiation between ISDNs: service agreement and connection agreement.

TABLE 4/I.520

**Relationship between speech processing and bearer services
within an ISDN and for an ISDN-ISDN interworking**

Speech processing functions	Bearer service					
	1	2	3	4		5
	Speech	3.1 kHz audio ^{a)}	64 kbit/s unrestricted	Alternate speech/64 kbit/s unrestricted ^{b)}		Multi-use
Speech				64 kbit/s		
Echo control ^{c)}	E ^{d) e)}	E ^{d) e)}	FD	e)	FD	FD ^{j)}
A- μ law conversion ^{f)}	E	E	FD	E	FD	FD ^{k)}
DSI	O	O ^{g)}	FD	O	FD	FD
LRE	O	O ^{g)}	FD	O	FD	FD
DCM	O	O ^{g)}	FD ^{h)}	O ⁱ⁾	FD ⁱ⁾	FD ^{h)}
Analogue facilities	O	O ^{g)}	P	P	P	P

E Essential
O Optional
P Prohibited
FD Functionally disabled
DSI Digital speech interpolation
LRE Low rate encoding (e.g. Recommendation G.721)
DCM Digital circuit multiplication employing LRE and DSI and having controllable flexibility in modes of operation.

a) For the 3.1 kHz audio bearer service, echo control is included in the connection at the time of call set-up. It is disabled for the transmission of voice-band data by use of the disabling tone (see Recommendations V.25 and I.530).

b) The exchange may set up a 64 kbit/s unrestricted bearer path with echo control devices and A- μ law converters (if necessary) enabled for speech. In any case, the set up of parallel paths for speech and 64 kbit/s unrestricted must be avoided.

c) Echo control needs to be disabled when continuity check is performed.

d) Although echo control may not be required in ISDN-ISDN interworking for digital telephones (for further study), its inclusion for possible internetworking reasons for the speech bearer service is essential (see also Recommendation I.530).

e) The necessity for network or terminal provided echo control in 4-wire end-to-end speech connections is for further study.

f) The IWF converting A- μ laws should also make the necessary bit translation in the bearer capability information element to indicate the law used.

g) The network may include signal processing techniques provided they are appropriately modified or functionally removed prior to information transfer.

h) The 64 kbit/s transparent capability will be invoked, subject to the available transmission capacity, by the adjoining exchange over a dedicated out-band signalling system.

i) The provision of this bearer service using DCM is subject to the ability of the out-band signalling system and the DCM equipment to execute in-call modifications initiated by the adjoining exchange.

j) As the multi-use call progresses through the international gateway (or other) exchange, it may be necessary to associate an echo control device(s) with the circuit, but in a disabled state. If subsequently interworking with the PSTN occurs, the device(s) can then be enabled by a Signalling System No. 7 backward message.

k) A- μ law conversion may need to be enabled when interworking occurs (refer to Recommendation I.501).

NOTE – The bearer services in columns 1, 2 and 3 of the table permit control of speech processing devices only at call set-up as required for the particular bearer service requested. The bearer service in column 4 requires additional post set-up user-to-network signalling (out-band by D-channel messages) in order to perform the required in-call service modifications between the relevant alternative services.

5.3.1 Service agreement between ISDNs

Service agreement between ISDNs is defined as established compatibility between the two networks on a requested service. The service agreement does not necessarily occur on a call-by-call basis, but in a pre-determined way which has been agreed by bilateral negotiation between the two ISDNs. If the service agreement is established, connection agreement then begins between the two ISDNs.

If the service agreement is not established, procedures are for further study, including the following four alternatives. Additionally, the impact of these alternatives on user-to-network protocols or internetwork protocols is for further study.

- 1) The call may be established without the service compatibility (e.g. in the case of a supplementary service request).
- 2) The call may be cleared.
- 3) Either of the ISDNs may negotiate with the originating user to change or abandon the user's service request.
- 4) Another alternative may be selected from the originating user's service profile.

5.3.2 Connection agreement between ISDNs

Connection agreement between ISDNs is defined as negotiation on the connection element between the two networks. Connection agreement is required when the connection elements employed in each ISDN are different, even if service agreement exists. (For example, see Appendix I.) The use of call progress indicators for this purpose is for further study.

In a speech bearer service, the objects for connection agreement might be the use of one of the following: UDI (unrestricted digital information)/RDI (restricted digital information), satellite circuits, DSI circuits, the difference of PCM coding rules, circuit selection between digital networks having different hierarchical structures, etc. Parameter exchange, if required, are executed by the two networks.

The connection agreement does not necessarily occur on a call-by-call basis, but in a pre-determined way which has been established by other Recommendations (e.g. Recommendation G.802 for interworking between hierarchies and Recommendation G.711 for A- μ law conversion) or agreed between two ISDNs.

5.4 Compatibility checking between end users of different ISDNs

When the connection path between two terminals on different ISDNs is established, low level compatibility (LLC), high layer compatibility (HLC) or user defined compatibility may be examined on an end-to-end basis.

Compatibility checking items between end users are as follows:

1) *Low layer compatibility*

LLC information would normally be used for user-to-user call negotiation and would be passed transparently through the networks. The IWF may, where required, examine and act on LLC information (see 2.2.1.3/I.515) in the cases where the LLC checking lists (see Recommendation Q.931) employed by the relevant ISDNs are different.

2) *High layer compatibility*

The HLC is to be conveyed transparently and the networks need not operate on it. The examination and action on HLC information by the IWF is for further study, in the case where the HLC checking lists employed by the relevant ISDNs are different.

3) User defined compatibility checking

User defined compatibility checking is the user responsibility. The network does not participate in this compatibility checking.

6 Functional interworking requirements for data transmission services

See Recommendation X.320 on general arrangements for interworking between ISDNs for the provision of data transmission services.

Network interworking requirements for the case where an X.31 based packet mode bearer service is requested on one ISDN and a new packet mode bearer service is requested on another ISDN will be provided when new packet mode bearer services are defined.

7 References

See Recommendation I.500.

Appendix I

ISDN connections involving restricted 64 kbit/s transfer capability

(This appendix does not form an integral part of this Recommendation)

I.1 General

For an interim period the existence of networks or parts of networks only capable of transferring 64 kbit/s in a restricted manner (i.e. 64 kbit/s octet structured transfer capability with the all-zero octet not permitted) will have to be taken into account for international interworking.

For those networks, or parts of networks, the following rules apply in order to allow communication with networks, or parts of networks, that already provide unrestricted 64 kbit/s transfer capability. The necessary interworking functions (e.g. interworking units, rate adaptors) have to be provided by the network with restricted 64 kbit/s transfer capability. Signalling provisions should be incorporated in Recommendation I.451/Q.931. The network with unrestricted 64 kbit/s transfer capability will not be affected by this interworking, other than transporting the appropriate signalling across this network to and from the terminal connected to the 64 kbit/s network.

I.2 Interworking with ISDNs providing restricted 64 kbit/s (see Figure I.1)

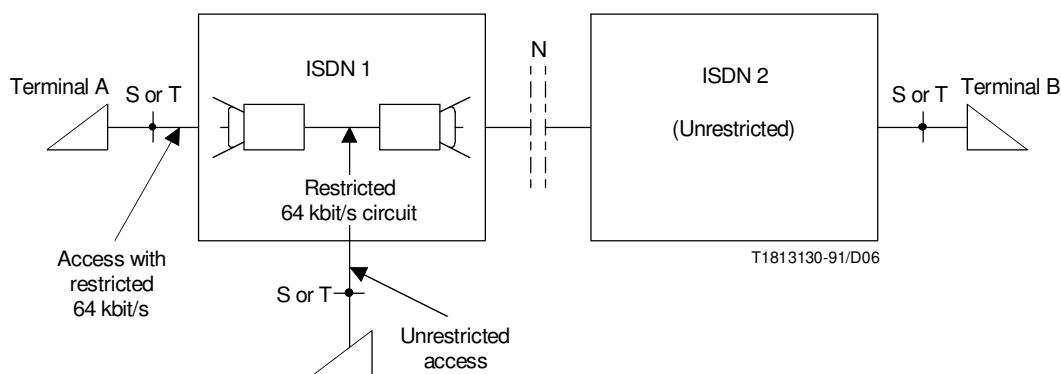

FIGURE I.1/I.520

Interworking with ISDNs providing restricted 64 kbit/s

ISDN 1 may have some arrangements having only restricted 64 kbit/s transfer capability. ISDN 2 is unrestricted. In both cases, at the reference points S or T, the I.412 user-network interfaces are provided. However, where restricted 64 kbit/s arrangements are involved, only information streams not having the all-zero octet are possible.

Four possible cases of interworking for circuit switched connections between terminals A and B are considered (UDI means unrestricted digital information and RDI means restricted digital information). (See Table I.1.)

TABLE I.1/I.520

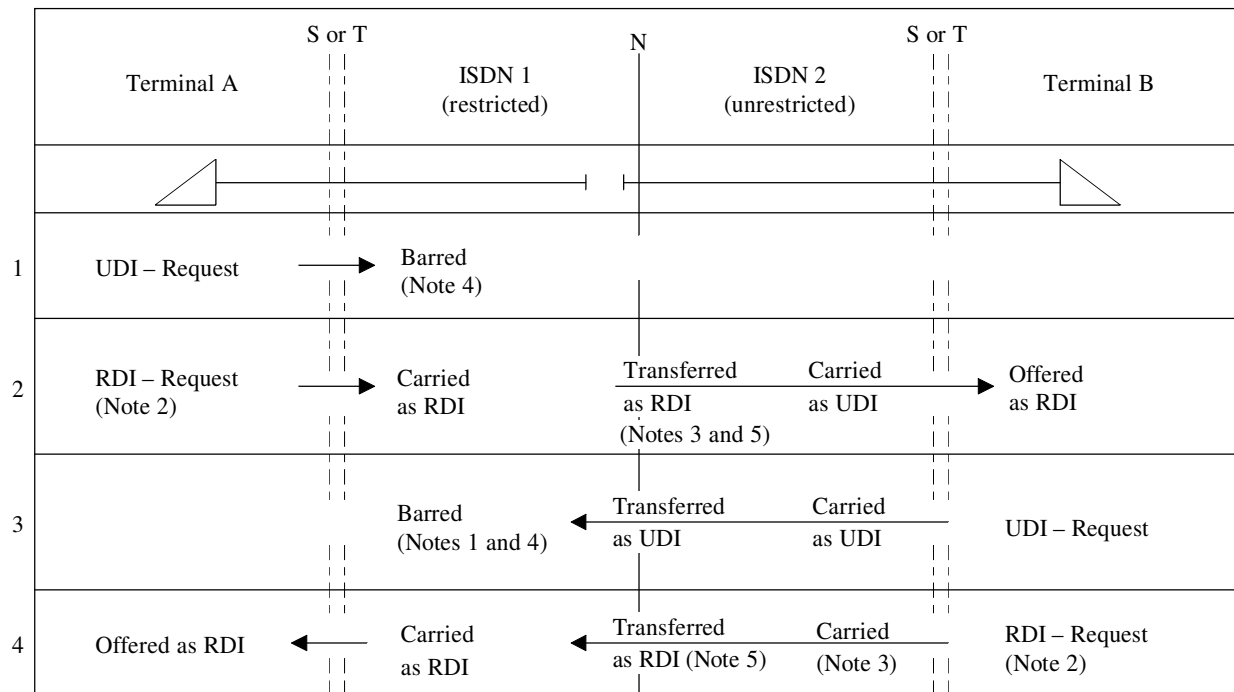

T1813140-91/D07

UDI Unrestricted digital information

RDI Restricted digital information

NOTES

- 1 Dependent upon national implementation, a UDI-request may also be barred at some place in ISDN 2, provided that it has a record of the restricted destinations/circuits.
- 2 The first and fourth columns of the table contain the signalling messages as generated or received by the terminals. The second and third columns are the transport capabilities of ISDN 1 and ISDN 2. The signalling messages would be transferred without change through the network signalling systems.
- 3 Some ISDN 2s may not recognize bearer capability coded as RDI, thus rejecting call request.
- 4 Dependent upon national implementation, UDI requests carrying rate-adapted information streams not having the all-zero octet, may be accepted by ISDN 1. For example, a UDI request indicating a user rate of 56 kbit/s and V.110 may be allowed by ISDN 1.
- 5 Only refers to the transfer of signalling information.
- 6 Choice of interworking implementation option, including scenarios not included in this table, is possible by bilateral agreement.

1.3 Considerations for terminal designed to operate with restricted 64 kbit/s transfer capability (see Figure I.2)

Existing terminals at rates less than 64 kbit/s will require rate adaptation to operate with restricted 64 kbit/s transfer capability (see Recommendation I.464).

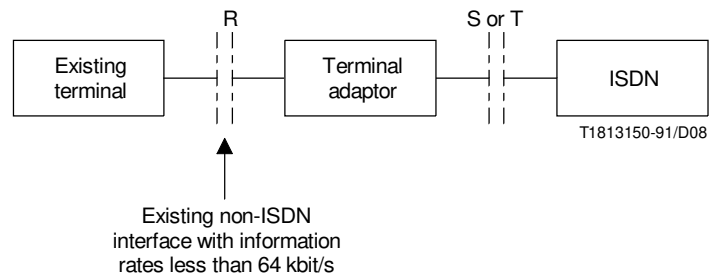

FIGURE I.2/I.520

Considerations for terminals with restricted 64 kbit/s transfer capability