



INTERNATIONAL TELECOMMUNICATION UNION

ITU-T

TELECOMMUNICATION
STANDARDIZATION SECTOR
OF ITU

I.372

(03/93)

**INTEGRATED SERVICES DIGITAL
NETWORK (ISDN)**

**OVERALL NETWORK ASPECTS AND
FUNCTIONS**

**FRAME RELAYING BEARER SERVICE
NETWORK-TO-NETWORK INTERFACE
REQUIREMENTS**

ITU-T Recommendation I.372

(Previously "CCITT Recommendation")

FOREWORD

The ITU Telecommunication Standardization Sector (ITU-T) is a permanent organ of the International Telecommunication Union. The ITU-T is responsible for studying technical, operating and tariff questions and issuing Recommendations on them with a view to standardizing telecommunications on a worldwide basis.

The World Telecommunication Standardization Conference (WTSC), which meets every four years, established the topics for study by the ITU-T Study Groups which, in their turn, produce Recommendations on these topics.

ITU-T Recommendation I.372 was prepared by the ITU-T Study Group XVIII (1988-1993) and was approved by the WTSC (Helsinki, March 1-12, 1993).

NOTES

1 As a consequence of a reform process within the International Telecommunication Union (ITU), the CCITT ceased to exist as of 28 February 1993. In its place, the ITU Telecommunication Standardization Sector (ITU-T) was created as of 1 March 1993. Similarly, in this reform process, the CCIR and the IFRB have been replaced by the Radiocommunication Sector.

In order not to delay publication of this Recommendation, no change has been made in the text to references containing the acronyms "CCITT, CCIR or IFRB" or their associated entities such as Plenary Assembly, Secretariat, etc. Future editions of this Recommendation will contain the proper terminology related to the new ITU structure.

2 In this Recommendation, the expression "Administration" is used for conciseness to indicate both a telecommunication administration and a recognized operating agency.

© ITU 1993

All rights reserved. No part of this publication may be reproduced or utilized in any form or by any means, electronic or mechanical, including photocopying and microfilm, without permission in writing from the ITU.

CONTENTS

Page

1	Introduction	1
2	Definitions	1
3	Network-to-network interface reference model	2
3.1	Locations of network-to-network interface	2
3.2	PVC Network-to network multi-network reference model	2
4	Network-to-network interface performance parameters	3
5	Frame relaying network functional architecture	4
5.1	Data transfer (U-plane)	4
5.2	Control plane (C-plane) requirements	5
5.3	Network management	5
5.4	Operation Administration and Maintenance (OAM)	5
6	Congestion management	6
7	PVC Management/Provisioning requirements	6
7.1	PVC network-to-network parameter coordination.....	6
7.2	PVC network-to-network management.....	7
8	SVC call control requirements	9
8.1	SVC network-to-network parameter negotiation.....	9
9	Lower layer requirements.....	9
9.1	Digital hierarchies	9
9.2	Broadband ISDN.....	10

FRAME RELAYING BEARER SERVICE NETWORK-TO-NETWORK INTERFACE REQUIREMENTS

(Helsinki, 1993)

1 Introduction

Recognizing the range of data applications and bit rates supported by frame relaying bearer services (FRBS) there is a need to develop the functionalities of the ISDN FRBS network-to-network interface as well as the UNI.

Recommendation I.233.1 defines the frame relaying bearer service (FRBS) requirements at the user-to-network interface. The bearer service provides, bi-directional transfer of protocol data units (PDU) (layer 2 frames) from one S- or T-reference point to another with the order preserved (see 3.1/I.233.1) and uses Recommendation Q.922 core functions (see Annex A/Q.922). The congestion management and control procedures are described in Recommendation I.370. The interworking requirements for the FRBS and other services are to be described in a future Recommendation.

The scope of this Recommendation is to define network-to-network interface requirements independently of the Lower Layer transport used (see Figure 1).

This Recommendation primarily defines permanent virtual circuit (PVC) requirements. Switched virtual circuit (SVC) requirements are outlined in 8, however, additional details are for further study.

Lower Layer requirements:

- digital hierarchies up to level 3 rates (34 368 kbit/s or 44 736 kbit/s) (see 9.1);
- broadband ISDN (B-ISDN) (see 9.2).

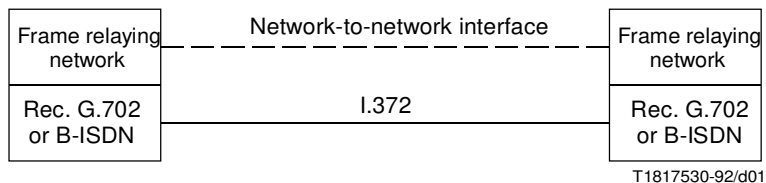

FIGURE 1/I.372
Definition of scope

2 Definitions

Terms and definitions are given in Recommendations I.113, I.233.1 and I.370.

3 Network-to-network interface reference model

3.1 Locations of network-to-network interface

Figure 2 illustrates possible locations of the network-to-network interfaces in a generic frame relaying network. The interfaces connect public frame relaying networks.

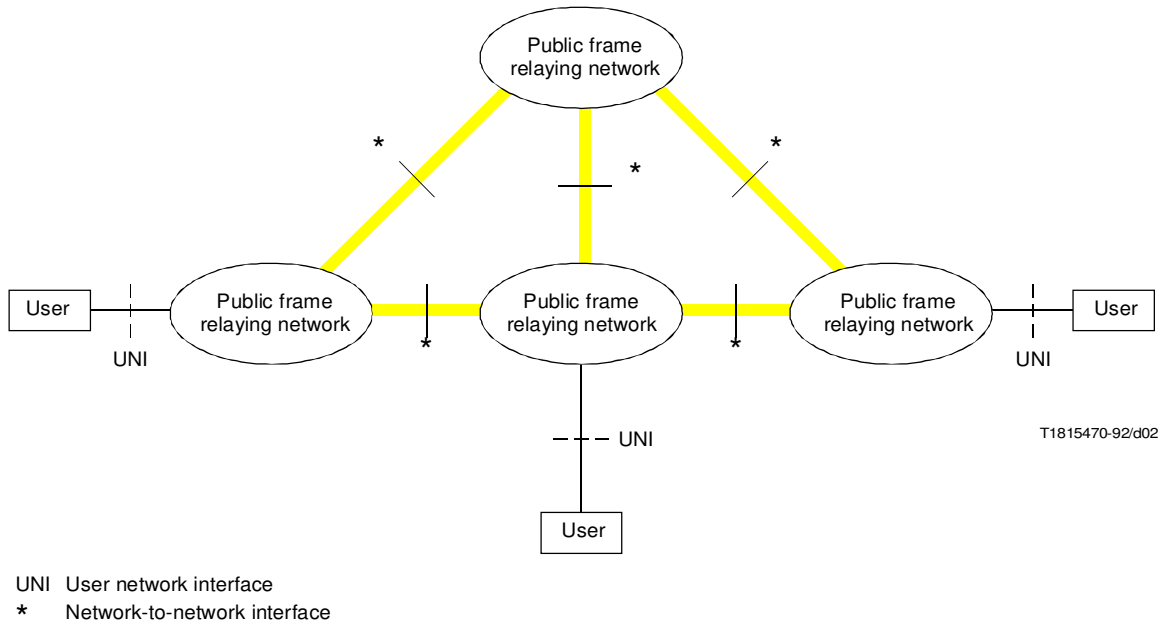

FIGURE 2/I.372

Reference model locations of network-to-network interface

Network-to-network interface requirements will be developed based on the above mentioned generic frame relaying networks and will address only the inter-network requirements. These requirements, as a minimum, should cover the following aspects:

- the U-plane information flows across the Network-to-Network Interface;
- the C-plane information flows across the Network-to-Network Interface;
- Operation, administration and maintenance (OAM).

Note – It is anticipated that the Network-to-network interface as given in this Recommendation may also be applied to public to private frame relaying network interfaces and private to private frame relaying network interfaces.

3.2 PVC Network-to network multi-network reference model

A multi-network PVC is a concatenation of two or more single PVC segments. A multi-network PVC should appear to each user as if only one network and one PVC were involved; the multi-network aspects should not appear (see Figure 3).

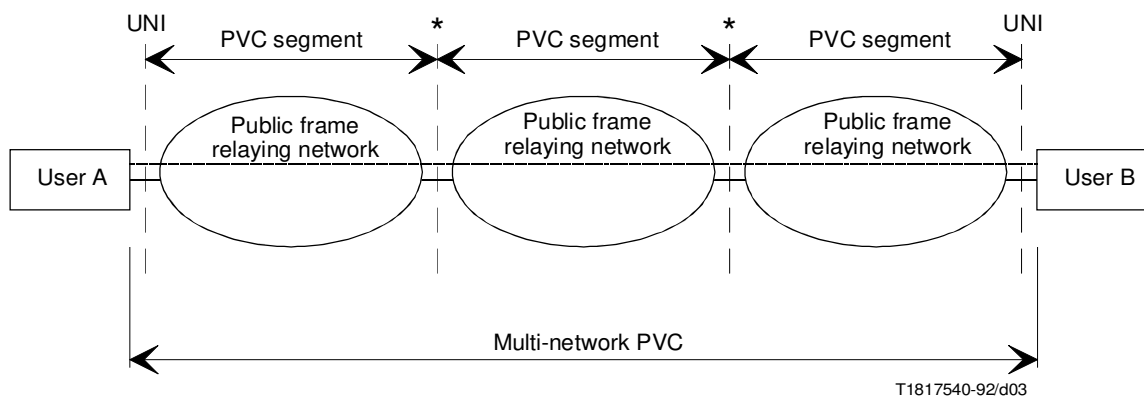

FIGURE 3/I.372
Multi-network PVC reference model

4 Network-to-network interface performance parameters

Frame relaying quality of service refers to service performance from the end-user standpoint. network-to-network performance parameters apply at different interfaces in the network. For a multi-network frame relaying service, the values of performance parameters at the network-to-network interface contribute to the service performance from the end-user standpoint.

The frame relaying quality of service parameters defined in Recommendation I.233.1 also apply at the network-to-network interface. These parameters are:

- throughput;
- access rate (AR);
- committed information rate (CIR);
- committed burst size (Bc);
- excess burst size (Be);
- transit delay;
- residual error rate;
- delivered errored frames;
- delivered duplicated frames;
- delivered out-of-sequence frames;
- lost frames;
- misdelivered frames.

The following descriptions identify other network-to-network interface performance parameters which should be taken in account:

- Availability which refers to the percentage of time that the Frame Relaying service is available within a long term scheduled service interval. The service is viewed as unavailable if it does not meet minimum acceptable service performance thresholds.
- Mean time between service outages: The mean time between service outages (MTBSO) is the average duration of any continuous interval during which the service is available.
- Mean time to restore: The mean time to restore (MTTR) is the average elapsed time from the time that loss of service is detected by the service provider to the time the service is fully restored. The time of loss of service is measured from the moment the first network-to-network interface detects its occurrence.

5 Frame relaying network functional architecture

The frame relaying network node functional architecture is composed of four functional groups, as shown in Figure 4.

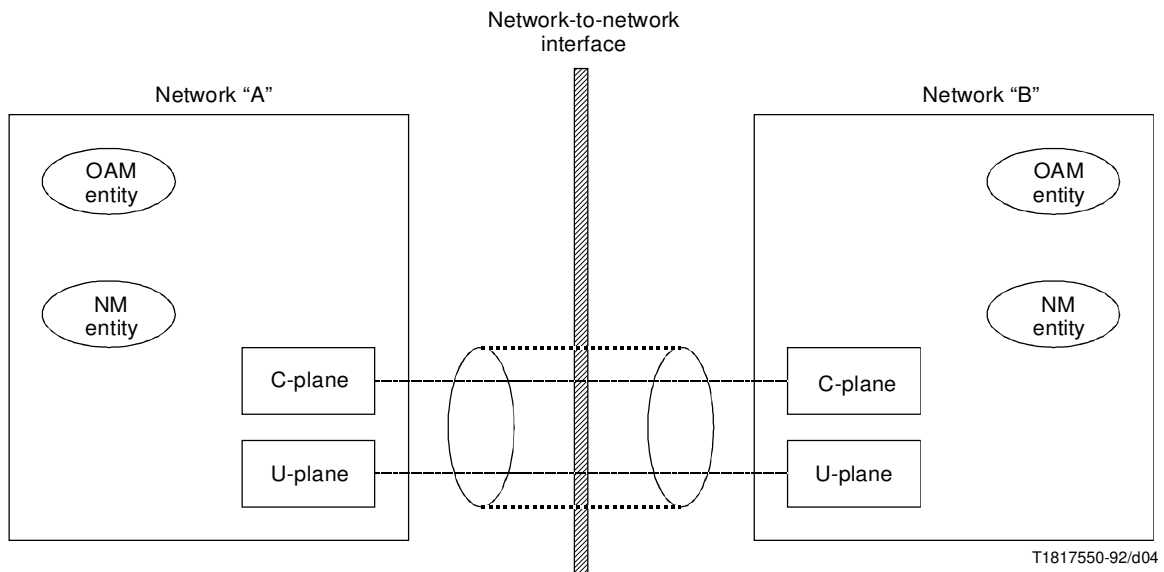

FIGURE 4/I.372

Frame relaying network functional architecture

The four functional groups are called the signalling plane (C-plane functional group), the user plane (U-plane functional group), the network management entity (NM-entity), and the operation, administration, and maintenance entity (OAM-entity).

A C-plane functional group is required to perform all the necessary processing and transmission of signalling information through the signalling link between those network nodes sharing the network-to-network interface.

A U-plane functional group is required to perform all the necessary processing and transmission of data through the data transfer link between any two nodes providing the network-to-network interface.

Within each network node providing a network-to-network interface, separate functional entities are required to govern the nodal operation. These entities can be grouped into the NM-entity and the OAM-entity. The NM-entity is the entity which performs the necessary network management functions, while the OAM-Entity is the entity which performs the necessary OAM functions. OAM and NM-entities interact with C and U-Planes for exchanging and updating status information about the C- and U-planes.

5.1 Data transfer (U-plane)

The network-to-network interface shall use core functions as specified in 3.1.1/I.233.1 and as given in Annex A/Q.922, for the user-network interface. Figure 5 shows the U-plane reference architecture for the transport of FRBS.

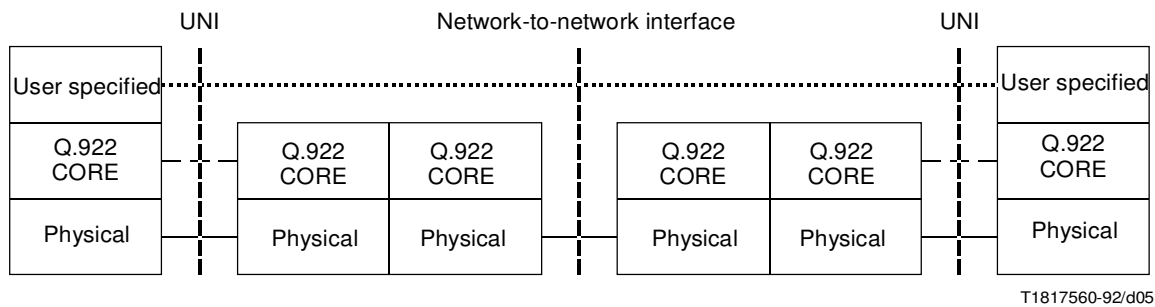

FIGURE 5/I.372
U-plane protocol reference architecture

The network-to-network interface must support a two octet DLCI address field.

In situations requiring more than two octets in the address field, the network-to-network interface should support a 4 octet address field length with a 17 bit DLCI field and the fourth octet used as a DL control field. The procedures for the DL-CORE control are for further study.

Note – The use of other Recommendation Q.922 defined address field formats is for further study.

The Frame Relaying Bearer service provides the U-plane core functions at the network-to-network interface as described in Annex C/I.233.1. The overview of core services, features of the core services, and data transfer are described in C.4.2/I.233.1, C.4.3/I.233.1, and C.4.4.5/I.233.1 respectively.

5.2 Control plane (C-plane) requirements

The C-plane within each frame relaying node (network) is responsible for all messaging between peer level network entities (e.g. the network management entity) connected via the network-to-network interface. In particular, the C-plane shall transport all network management entity and network-to-network related OAM information between two frame relaying nodes at the network-to-network interface reference point.

5.3 Network management

Network management functions include:

- network-to-network interface trunk management;
- route management;
- PVC identification management.

Additional details and specific requirements are for further study.

5.4 Operation Administration and Maintenance (OAM)

The OAM functions include:

- human (network operator) interface support;
- alarms reporting;
- control and network procedures for problem diagnosis.

Additional details and specific requirements are for further study.

6 Congestion management

Congestion management and control are described in Recommendation I.370.

Additional congestion management principles applicable to the network-to-network interface are as follows:

Each network is responsible for protecting itself against congestion scenarios at the network-to-network interface (e.g. a given network should not rely solely on the prior network's setting of the DE bit).

Data relayed between the UNI and the network-to-network interface may modify traffic characteristics at the network-to-network interface. If rate enforcement is performed at the network-to-network interface, using the same parameter values (CIR, Bc, Be) as used at the UNI, frames accepted as Bc data at the UNI may be discarded or marked DE (and subsequently treated as Be data) at the network-to-network interface.

Committed burst size (Bc) data should not be discarded at the network-to-network interface under normal operating conditions. One method to assure this, is to limit the sum of the subscribed CIRs (egress from the network) of all PVCs on a given network-to-network interface to be less than the network-to-network interface transmission rate.

7 PVC Management/Provisioning requirements

Coordination of service parameters is to be achieved through bilateral agreement of the network operators.

Permanent virtual circuit (PVC) status management procedures should be implemented using symmetric operations between networks.

Data link connection identifier (DLCI) assignment between networks is to be achieved through bilateral agreement.

Bandwidth allocation between networks is to be achieved through bilateral agreement.

Routing between networks is to be achieved through bilateral agreement.

A PVC that spans multiple frame relaying networks will be engineered to an agreed quality of service through bilateral agreement. This may be in accordance with Recommendation I.370 or other agreed upon means.

Each Frame Relaying service provider is responsible for the OAM of the PVC segment within its network boundaries only.

Two service categories, which may impact parameter coordination, should be supported by frame relaying networks. One service category has characteristics expressed by a committed information rate (CIR) of 0. The other service category has characteristics expressed by a CIR of > 0. These values are used to determine the measurement interval parameter T in Table 1.

Table 1 shows the possible relationships of CIR, Committed Burst Size (Bc), and Excess Burst Size (Be). It should be noted that the two cases of CIR > 0 have been combined for simplicity of expressing service category characteristics.

7.1 PVC network-to-network parameter coordination

The core service provided by the frame relaying bearer services, is described in C.4.3/I.233.1. The network-to-network interface should provide the same quality of service as that supported between peer core service users. The FRBS service quality is characterized by quality of service (QOS) parameters as defined in 3.1/I.233.1. For PVCs, these parameters are administratively coordinated at subscription time.

TABLE 1/I.372

Possible relationships of CIR, Bc and Be

CIR	Committed burst size (Bc)	Excess burst size (Be)	Measurement interval (T)
> 0	> 0	> 0	$T = Bc/CIR$
> 0	> 0	= 0	$T = Bc/CIR$
= 0	= 0	> 0	(Note)

NOTE – T is a network dependent value. The ingress and egress access rates (AR) do not have to be equal; however, when the ingress AR is substantially higher than the egress AR, continuous input of Be frames as the ingress interface may lead to persistent congestion of the network buffers at the egress interface, and a substantial amount of the input Be data may be discarded.

The QOS parameter values administratively coordinated at the network-to-network interface include: committed information rate, transit delay, and frame loss ratio. Additional parameters including Bc, Be, frame size, and DLCI should also be administratively coordinated at the network-to-network interface. If a user does not specify a value for a particular parameter, then a network default value is assumed. Default values may be network specific or may be established by subscription. This applies to both QOS and link layer core parameters.

7.2 PVC network-to-network management

Figure 3 illustrates PVC segments connected in a multi-network configuration.

A multi-network PVC is a concatenation of two or more single PVC segments. A multi-network PVC should appear to each user as if only one network and one PVC were involved; the multi-network aspects should not appear.

PVC network-to-network management functions include, but are not limited to

- bi-directional status enquiry (symmetry);
- link status queries and responses;
- PVC status enquiries and responses;
- asynchronous PVC status changes.

The management functions of the network-to-network interface for Frame Relaying PVC service includes the management functions of the UNI (Annex A/Q.933) plus the following list of enhancements:

- A PVC status response protocol that does not restrict the total number of PVCs provisioned on the interface.
- Loop back control to assist in fault sectionalization and additional procedures for aiding real time identification of failed PVCs, such as continuity checking, and performance measurements. This capability may use the transfer of OAM frames interleaved with user frames in the U-plane.
- Report of network-to-network trunk error statistics.

A reference model for a simple OAM protocol layer supported directly on the core functions of Recommendation Q.922 is shown in Figure 6. This protocol should be carried within a specific logical link at the network-to-network interface. The use of this protocol will allow the networks to communicate the status of provisioned PVC connections.

Figure 7 illustrates protocol architecture for implementations that require coexistence of PVCs and SVCs on the same interface. As users migrate to SVCs, use of the functionality of Annex B/Q.933 should be encouraged.

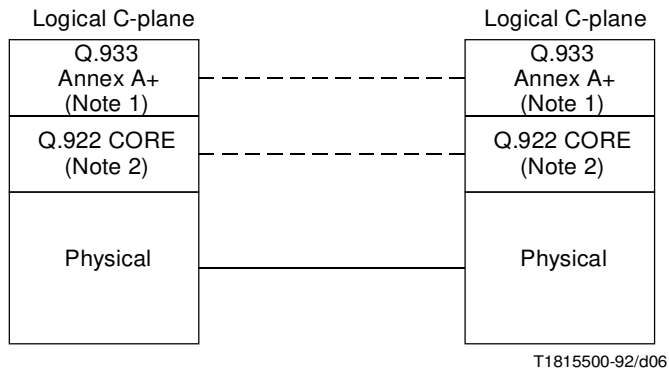

NOTES

- 1 Annex A+ represents the enhanced version of Annex A to support additional network-to-network requirements.
- 2 As specified in Annex A/Q.933, unacknowledged information (UI) frames are used above Q.922 core.

FIGURE 6/I.372
OAM information exchange for PVCs only

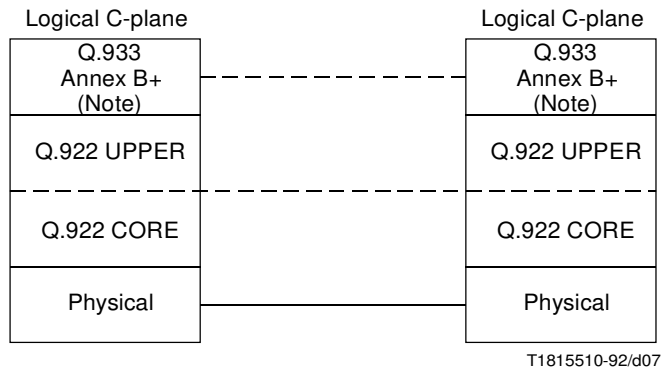

NOTE – Annex B+ represents the enhanced version of Annex A to support additional network-to-network requirements.

FIGURE 7/I.372
OAM information exchange for SVCs/PVCs

This OAM capability is required at both the user-network interface and the network-to-network interface. The protocol architecture should be the same at both interfaces.

8 SVC call control requirements

During call set-up, the network-to-network interface should carry both the information needed for the network to set up the call and to subsequently provide end-to-end transparent transport of user information.

Symmetrical signalling procedures are to be used across the network-to-network interface. Data link connection identifier negotiation is executed at call set-up via signalling procedures.

Bandwidth allocation is executed at call set-up via signalling procedures.

Routing is executed at call set-up via signalling procedures. In a public network environment, network-to-network interface selection may be based on a transit network selection information element provided in the originating user-to-network setup message.

Parameter negotiation including QOS is executed at call set-up (see 5.1.3.3/Q.933).

NOTES

1 For SVC service in large single networks, or in multiple networks, the value of connection establishment and connection release timers may have to be increased from the default values in Recommendation Q.933.

2 The use of Q.933 and/or Signalling System No. 7 is for further study.

Two service categories, which may impact parameter negotiation, should be supported by frame relaying networks. One service category has characteristics expressed by a CIR of 0. The other service category has characteristics expressed by a CIR of > 0 . These values are used to determine the measurement interval parameter T in Table 1.

Table 1 shows the possible relationships of CIR, Bc, and Be. It should be noted that the two cases of CIR > 0 have been combined for simplicity of expressing service category characteristics.

8.1 SVC network-to-network parameter negotiation

The core service provided by the Frame Relaying Bearer Service is described in C.4.3/I.233.1. The network-to-network interface should provide the same quality of service as that supported between peer core service users. The FRBS service quality is characterized by Quality of Service (QOS) parameters as defined in 3.1/I.233.1.

For SVCs, QOS parameters are negotiated during frame relaying call establishment. This will also involve negotiation at the network-to-network interface. Additional QOS parameters for SVCs are for further study.

The QOS parameter values exchanged at the network-to-network interface include committed information rate, transit delay, and frame loss ratio. Additional parameters including Bc, Be, and frame size should also be exchanged at the network-to-network interface. If a user does not specify a value for a particular parameter, then a default value is assumed. Default values may be network specific or may be established by subscription. This applies to both QOS and link layer core parameters.

9 Lower layer requirements

9.1 Digital hierarchies

Digital hierarchies are defined in Recommendation G.702.

The network-to-network trunk interfaces may include Digital hierarchy bit rates up to level 3 (34 368 kbit/s or 44 736 kbit/s) as defined Recommendation G.702. The recommended trunk interfaces supported are:

- Recommendation G.703 – Physical/Electrical characteristics of hierarchical digital interface;
- Recommendation G.704 – Synchronous frame structures at primary and secondary hierarchical levels;
- Recommendation G.751 – Digital multiplex equipment operating at the third order bit rate.

9.2 Broadband ISDN

Broadband ISDN lower layers are defined in Recommendations I.150, I.321, I.361, I.362, and I.363.

As the network traffic grows, the use of ISDN rates may limit the evolution of the frame relaying network. Therefore, support of higher rate network-to-network interface transmission will be required. Figure 8 shows the U-plane protocol reference architecture for the transport of frames via ATM cells and the supporting SDH physical layer. The ATM layer transports frames mapped into cells across the network-to-network interface.

When two frame relaying networks are connected by B-ISDN/ATM, the B-ISDN virtual connection (virtual path/virtual channel) will be treated as a trunk between networks. The B-ISDN virtual connection will have the following characteristics: connection mode, message mode, unassured service, variable bit rate, and timing not required. Frames are carried by ATM transport between the two frame relaying networks.

Figure 8 shows the U-plane reference architecture for the transport of frames using B-ISDN. The ATM layer transports frames that are mapped into cells between the Frame Relaying networks.

Figure 8 shows that some core functions need to be carried transparently through B-ISDN. Other functions, e.g. loop back control, may need to be mapped into the AAL and ATM layers.

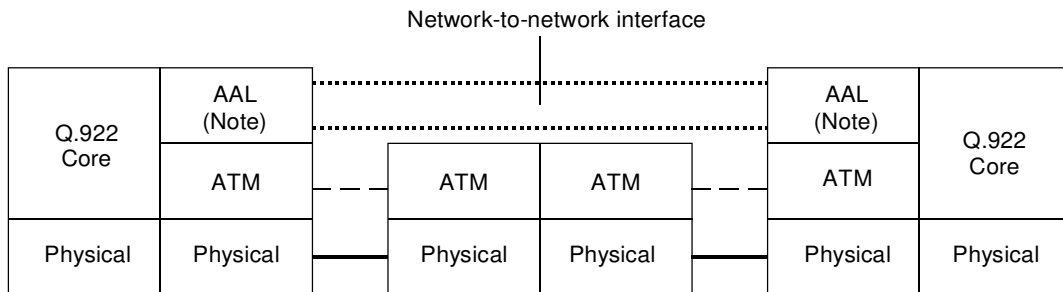

T1817570-92/d08

- NOTE – AAL will provide the necessary functions such as:
- segmentation, reassembly, and error detection;
 - frame multiplexing/demultiplexing using the address field;
 - inspection of the frame to ensure that it consists of an integer number of octets;
 - inspection of the frame to ensure that it is neither too short;
 - congestion control function.

The details of this functionality are to be the subject of a future Recommendation.

FIGURE 8/I.372
**Network-to-network interface using B-ISDN/ATM virtual connection
(virtual path or virtual channel)**