



INTERNATIONAL TELECOMMUNICATION UNION

**ITU-T**

TELECOMMUNICATION  
STANDARDIZATION SECTOR  
OF ITU

**I.210**

(03/93)

**INTEGRATED SERVICES DIGITAL  
NETWORK (ISDN)  
SERVICE CAPABILITIES**

---

**PRINCIPLES OF TELECOMMUNICATION  
SERVICES SUPPORTED BY AN ISDN  
AND THE MEANS TO DESCRIBE THEM**

**ITU-T Recommendation I.210**

(Previously "CCITT Recommendation")

---

## FOREWORD

The ITU Telecommunication Standardization Sector (ITU-T) is a permanent organ of the International Telecommunication Union. The ITU-T is responsible for studying technical, operating and tariff questions and issuing Recommendations on them with a view to standardizing telecommunications on a worldwide basis.

The World Telecommunication Standardization Conference (WTSC), which meets every four years, established the topics for study by the ITU-T Study Groups which, in their turn, produce Recommendations on these topics.

ITU-T Recommendation I.210 was revised by the ITU-T Study Group XVIII (1988-1993) and was approved by the WTSC (Helsinki, March 1-12, 1993).

---

## NOTES

1 As a consequence of a reform process within the International Telecommunication Union (ITU), the CCITT ceased to exist as of 28 February 1993. In its place, the ITU Telecommunication Standardization Sector (ITU-T) was created as of 1 March 1993. Similarly, in this reform process, the CCIR and the IFRB have been replaced by the Radiocommunication Sector.

In order not to delay publication of this Recommendation, no change has been made in the text to references containing the acronyms "CCITT, CCIR or IFRB" or their associated entities such as Plenary Assembly, Secretariat, etc. Future editions of this Recommendation will contain the proper terminology related to the new ITU structure.

2 In this Recommendation, the expression "Administration" is used for conciseness to indicate both a telecommunication administration and a recognized operating agency.

© ITU 1993

All rights reserved. No part of this publication may be reproduced or utilized in any form or by any means, electronic or mechanical, including photocopying and microfilm, without permission in writing from the ITU.

## CONTENTS

	<i>Page</i>
1 General.....	1
2 Service concepts.....	1
3 Customer access to telecommunication services supported by an ISDN .....	2
4 Capabilities to support a telecommunication service.....	3
5 Telecommunication service classification.....	5
5.2 Bearer services supported by an ISDN.....	5
5.3 Teleservices supported by an ISDN .....	6
5.4 Supplementary services supported by an ISDN.....	8
6 Provision of telecommunication services .....	9
Annex A – Structure for prose service definition and description – Step 1.1 of description method .....	9
A.1 Structure of prose service definition and description.....	9
A.2 Explanation of the terms and content of the items in the service prose definition and description .....	10
Annex B – List of attributes and their possible values for describing bearer services – Step 1.2 of description method.....	12
B.1 Framework for the static description of bearer services supported by an ISDN.....	12
B.2 List of bearer service attributes.....	12
Annex C – List of attributes and their possible values for describing teleservices – Step 1.2 of description method.....	18
C.1 Framework for the static description of teleservices supported by an ISDN.....	18
C.2 List of the teleservice attributes .....	18
C.3 List of the service component attributes.....	25
Annex D – Dynamic description of the service using graphic means – Step 1.3 of description method .....	27
D.1 Introduction .....	27
D.2 Overall specifications and description language (OSDL) diagrams.....	27



## **PRINCIPLES OF TELECOMMUNICATION SERVICES SUPPORTED BY AN ISDN AND THE MEANS TO DESCRIBE THEM**

*(Malaga-Torremolinos, 1984; amended at Melbourne, 1988 and at Helsinki, 1993)*

### **1 General**

An ISDN will support a wide range of services as described generally in Recommendation I.120. The purpose of this Recommendation is to provide a classification of such services, the means for the description of such services based on the description method as defined in Recommendation I.130, and to give a basis for the definition of the network capabilities required by an ISDN. These network capabilities are defined in the I.300-Series Recommendations.

Using the service concepts and the means for the description of services as given in this Recommendation, recommended bearer services are defined and described in the I.230-Series Recommendations, recommended teleservices are defined and described in the I.240-Series Recommendations and recommended supplementary services are defined and described in the I.250-Series Recommendations.

### **2 Service concepts**

**2.1** Services supported by an ISDN are the communication capabilities made available to customers by telecommunication service providers. An ISDN will provide a set of network capabilities which are defined by standardized protocols and functions and enable telecommunication services to be offered to customers.

A service provision by a telecommunication service provider to a customer connected to an ISDN may cover the whole or only part of the means required to fully support the service. The operational and commercial features associated with provision of the service are included in the service concept.

The service classification and descriptions which follow are independent of different possible arrangements for ownership and provision to the customer of the means required to support a service. The customer may therefore be offered, by the Administration, services or service support.

**2.2** The method used for the characterization of telecommunication services is described in Recommendation I.130 "Method for the characterization of telecommunication services supported by an ISDN and network capabilities of an ISDN". Within this method the first stage is an overall service description from the user's point of view. In stage 1 there are three steps:

- Step 1.1: Prose service definition and description;
- Step 1.2: Static description of the service using attributes;
- Step 1.3: Dynamic description of the service using graphic means.

Together these three steps define the service characteristics as they apply at a given reference point where the customer accesses the service.

Annexes A to D give the format of stage 1 service descriptions as follows:

- Annex A: Structure for prose service definition and description;
- Annex B: List of attributes and their possible values for describing bearer services;
- Annex C: List of attributes and their possible values for describing teleservices;
- Annex D: Dynamic description of the service using graphic means.

#### **NOTES**

- 1 Recommendation I.140 describes the use of attributes for this purpose.
- 2 The use of attributes for describing supplementary services is for further study.

This format allows the information contained within stage 1 to be structured in a consistent, comprehensive and logical manner. Only one overall format is recommended but it is recognized that certain sections of this format are only applicable to certain types of services.

**2.3** Telecommunication services are classified using their static characteristics described by attributes. Therefore this Recommendation (except Annexes A and D) deals mainly with step 1.2 of the description method.

A telecommunication service is, from the static point of view, composed of

- technical attributes as seen by the customer; and
- other attributes associated with the service provision, e.g. operational and commercial attributes.

Realization of the technical attributes of a telecommunication service requires a combination of network and terminal capabilities and other service providing systems.

**2.4** Telecommunication services are divided into two broad families, i.e.

- bearer services; and
- teleservices.

A supplementary service modifies or supplements a basic telecommunication service. Consequently, it cannot be offered to a customer as a stand alone service. It must be offered together with or in association with a basic telecommunication service. The same supplementary service may be common to a number of telecommunication services.

NOTE – The concept of supplementary services corresponds to the concept of optional user facilities in the X-Series Recommendations.

The concepts introduced here are illustrated in Table 1 and are defined in more detail in 5.

TABLE 1/I.210

**Classification of telecommunication services**

Telecommunication service			
Bearer service		Teleservice	
Basic bearer service	Basic bearer service + supplementary services	Basic teleservice	Basic teleservice + supplementary services

### 3 Customer access to telecommunication services supported by an ISDN

**3.1** Considering the reference configurations defined in Recommendation I.411, customers can access various telecommunication services at different access points. Figure 1 shows these access points.

This figure takes into account the fact that the network provider may offer to a customer connected to an ISDN the whole or only part of the means to fully support the service.

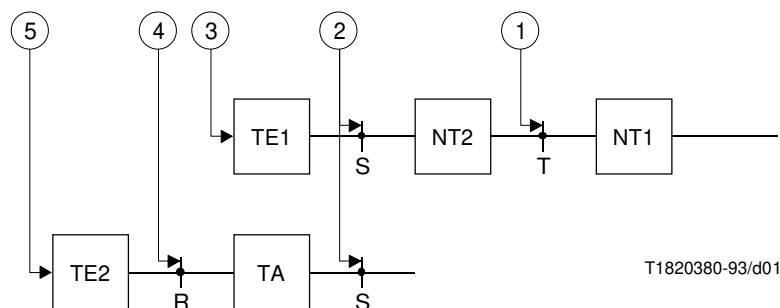

FIGURE 1/I.210

**Customer access to services supported by an ISDN**

**3.2** The definitions of the access points introduced in Figure 1 are as follows:

- i) Access points 1 (reference point T) and 2 (reference point S) are the access points for bearer services supported by an ISDN. The choice between access point 1 (T) and 2 (S) depends on the ownership and form of provision (to the customer) of the communications equipment at the customer premises. The service classification and descriptions in the following are independent of different possible arrangements for such provision.
- ii) At access point 4 (reference point R), depending on the type of terminal adaptors provided, other CCITT standardized services may be accessed, e.g. according to the X- and V-Series Recommendations.
- iii) At access points 3 and 5 (user-to-terminal interface), teleservices are accessed – the teleservice concept includes the terminal capabilities.

**3.3** The following customer entities may be connected at access points 1 and 2:

- customer terminals;
- customer systems, e.g. PABXs, LANs, service vendor systems;
- private networks.

NOTE – Customer terminals and systems may be private or provided by Administrations.

All customer equipment connected to an ISDN interface at one of these access points should meet the specifications of the protocols at that interface for all the layers that are included in the definition of the telecommunication service used.

For some telecommunication services the service definition also covers some terminal functions and characteristics in addition to those specified by the protocols at the interface. This relates in particular to teleservices, and also to supplementary services (see Recommendation I.250).

**3.4** From the user's point of view the telecommunication services as defined in the I.200-Series Recommendations will be used for some applications. For example, the telephony teleservice will be typically used for a human conversation (application). Likewise bearer services will be used for applications. The area of applications is outside the scope of the I-Series Recommendations. The user's application of services is the responsibility of the user and not of the network. The network can have no knowledge of what application is being used at any given time.

**3.5** The telecommunication service, as described in this Recommendation, is time-independent, that is to say that the description is valid for all the time the service is available. Whenever a demand or reserved service is invoked by a user, then the particular instance of the service is referred to as a *call*. Similarly, the instance also applies to the application as described in 3.4. The instance of an application is referred to as a *communication*.

## **4 Capabilities to support a telecommunication service**

**4.1** The capabilities required to fully support a telecommunication service for a customer connected to an ISDN include:

- network capabilities;
- terminal capabilities, when required;
- other services providing capabilities, when required;
- operational and commercial features associated with the service provision (i.e. sales or marketing aspects).

**4.2** Network capabilities are described in detail in Recommendation I.310. Two different levels of ISDN network capabilities are introduced in that Recommendation:

- low layer capabilities which relate to bearer services;
- high layer capabilities which together with low layer capabilities relate to teleservices.

The low layer capabilities are defined as a set of low layer functions (LLF) (relating to layers 1-3 in Recommendation X.200) which provide the capability for the carriage of user information over an ISDN connection. These functions include:

- basic low layer functions (BLLF) supporting the necessary layer 1-3 requirements;
- additional low layer functions (ALLF) supporting, in addition to BLLFs, lower layer requirements of supplementary services.

High layer capabilities are defined as a set of high layer functions (HLF) generally associated with layers 4 to 7 in Recommendation X.200.

High layer functions are sub-divided into basic high layer functions (BHLF) and additional high layer functions (AHLF).

NOTE – Depending on national regulations, ALLF, BHLF, and AHLF may be provided by administrations, or other suppliers.

**4.3** The concept of describing network capabilities in terms of low layer capabilities and high layer capabilities can equally be applied to describe terminal capabilities. In the description of teleservices the HLF and LLF are included in the service definition. In the case of bearer service definition the terminal capabilities are not included but the terminal must conform to the LLF of the bearer service.

NOTE – The relationships between service categories, network/terminal capabilities and functions are illustrated in Table 2.

TABLE 2/I.210

**Relationship between service categories, network/terminal capabilities and functions**

Telecommunication service	Network capabilities specified				Terminal capabilities specified				Commercial features/Operational capabilities
	LLF		HLF		LLF		HLF		
	BLLF	ALLF <sup>a)</sup>	BHLF <sup>a)</sup>	AHLF <sup>a)</sup>	BLLF	ALLF	BHLF	AHLF	
Bearer service	X	Optional	–	–	–	–	–	–	X
Teleservice	X	Optional	Optional	Optional	X	Optional	X	Optional	X
<sup>a)</sup> Depending on national regulations, ALLF, BHLF and AHLF may be provided by administrations or other suppliers. X Specified – Not specified									

**4.4** The operational service capabilities associated with a service offering may include capabilities for maintenance, charging, user control of service features, etc.

The use of such capabilities may involve terminal-network communication and may therefore be viewed as specific applications.

A more precise description of these capabilities and the relationship to Recommendation X.200 needs further study.



## 5 Telecommunication service classification

5.1 The static characteristics of a telecommunication service supported by an ISDN are described by service attributes. They are given in Annexes B and C.

There are two groups of service attributes applicable to user information flow:

- low layer attributes;
- high layer attributes.

Bearer services are defined as including only low layer attributes. Teleservices are defined as including both low layer attributes and high layer attributes.

The relationship between telecommunication service attributes and low/high layer functions is illustrated in Figure 2.

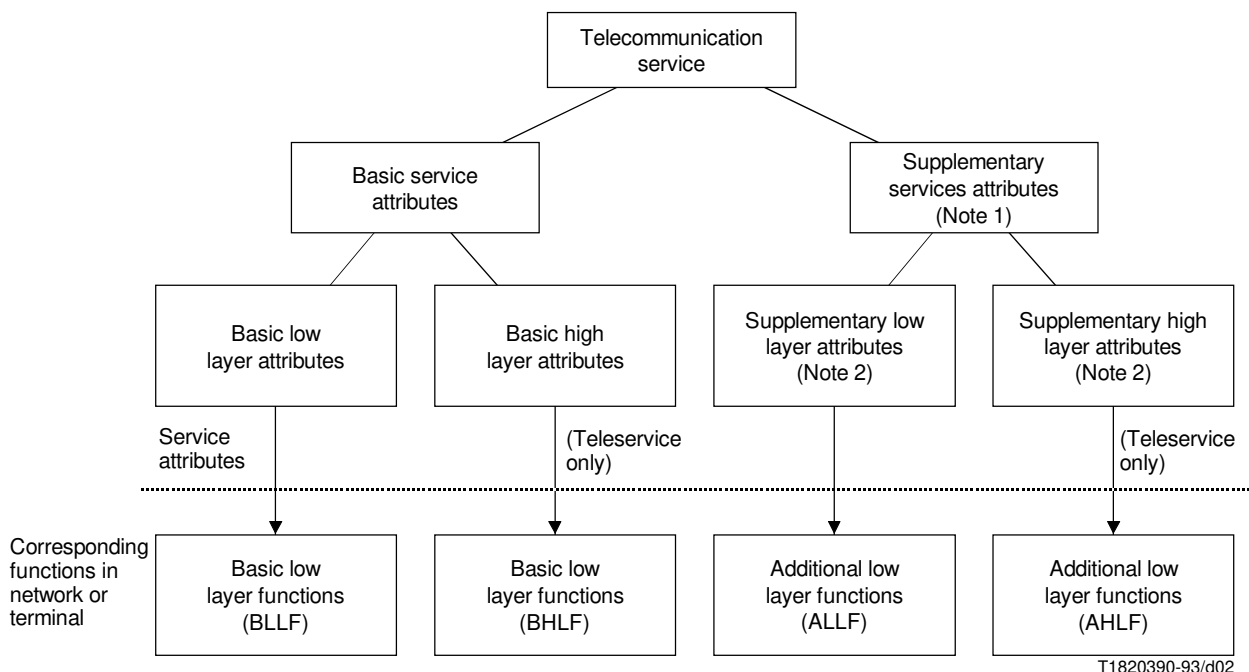

### NOTES

- 1 A supplementary service cannot be offered as a stand alone service. This attribute is mainly concerned with supplementary services associated to basic telecommunications services. It could be split into sub-attributes depending on results of further studies. Supplementary services could also have an influence on some attributes characterizing basic telecommunication services.
- 2 The characterization of supplementary services using attributes requires further studies.

FIGURE 2/I.210  
Relationship between service attributes and low/high layer functions

## 5.2 Bearer services supported by an ISDN

5.2.1 Bearer services supported by an ISDN provide the capability for information transfer between ISDN access points 1 or 2 and involve only low layer functions.

The customer may choose any set of high layer (at least 4 to 7) protocols for his communication, and the ISDN does not ascertain compatibility at these layers between customers. An example of a bearer service is a demand circuit-mode, 64 kbit/s unrestricted, 8 kHz structured bearer service.

**5.2.2** Bearer services are characterized from a static point of view by a set of low layer attributes given in Annex B. These attributes are classified into three categories:

- information transfer attributes;
- access attributes; and
- general attributes, including operational and commercial attributes.

The bearer capability defines the technical features of a bearer service as they appear to the user at the appropriate access point (1 or 2).

The bearer capability is characterized by information transfer and access attributes. A bearer capability is associated with every bearer service.

NOTE – It is likely that some Quality of Service parameters – such as error rate or call set-up delay – should be extracted in order to form a new attribute allocated to the information transfer category. Identification and definition of such parameters require further consideration.

Individual bearer services categories are defined and described in the I.230-Series Recommendations.

**5.2.3** A bearer service provides the user with the possibility of gaining access to various forms of communication, covering for example:

- information transfer between users employing the same access points (1 or 2) and access attributes (see Figure 3 a);
- information transfer between users employing different access attributes at the access points (1 or 2) involved (see Figure 3 b); and
- information transfer between a user and a separate resource providing high layer functions (see Figure 3c).

### **5.3 Teleservices supported by an ISDN**

**5.3.1** Teleservices provide the full capacity for communication by means of terminal and network functions and possibly functions provided by dedicated centres.

A teleservice supported by an ISDN should use only one (or a small number of) bearer capability(ies) recommended by the CCITT. It should be noted that in the case where more than one of the recommended bearer capabilities is used for a given teleservice, network interworking functions may be required under the responsibility of the teleservice provider. However, a user operating a specific application is not prevented from using a terminal compatible with a given teleservice in association with a bearer capability not recommended for this teleservice. Examples of teleservices are telephony, teletex and videotex.

**5.3.2** Teleservices are described from a static point of view by a set of low layer and high layer attributes, and operational and commercial attributes, as given in Annex C.

Low layer attributes are those used to characterize the bearer capability (see 5.2.2). High layer attributes are used in Recommendation I.241 to describe message-related (i.e. message on layer 7) characteristics of a service (basic high layer attributes) or of a supplementary service (supplementary high layer attributes). They refer to the functions and protocols of layers 4 to 7 in the Recommendation X.200 framework which are concerned with the transfer, storage and processing of user messages (provided by a subscriber's terminal, a retrieval centre, or a network service centre).

Therefore, not all these attributes can be applied directly at the user-to-terminal interface (access points 3 or 5) as they represent two kinds of features, the bearer capability and the terminal features, that are not directly perceived by the user.

The definition of appropriate attributes and the specifications of teleservices at this access point from the user point of view (man-machine interface) is for further study and the subject of E- and F-Series Recommendations.

Individual teleservices are defined and described in the I.240-Series Recommendations.

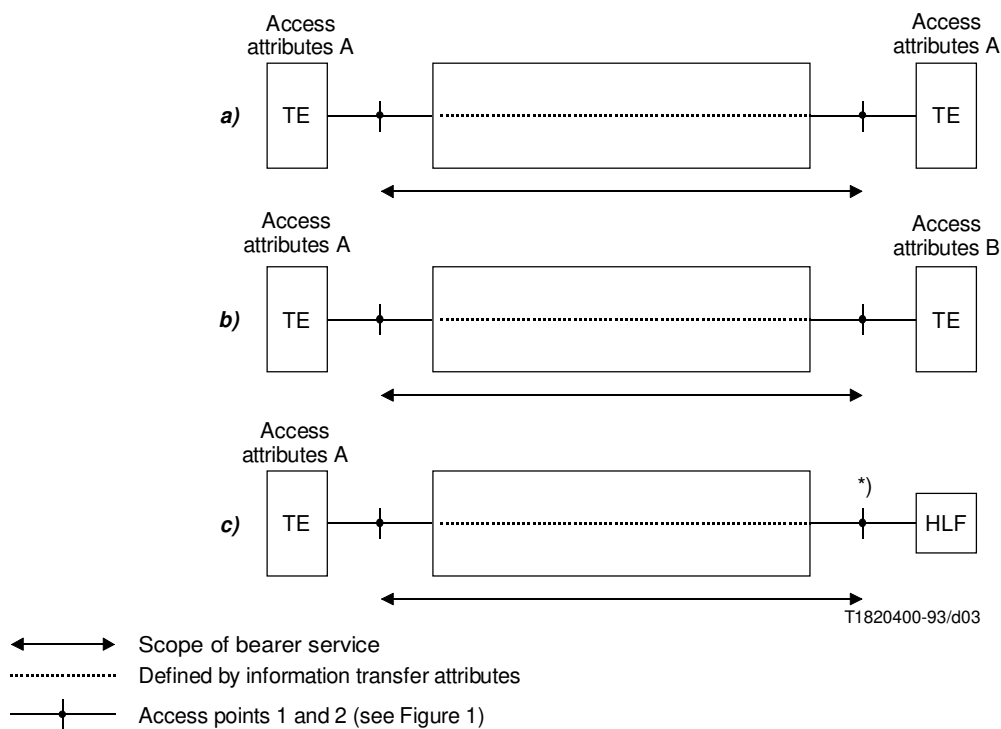

\*) Access point to be defined but not necessarily subject to CCITT Recommendations (See Recommendation I.324).

#### NOTES

- 1 Further study is required on bearer services extending beyond the ISDN.
- 2 Further study is required on possible communications involving bearer services with different values allocated to information transfer attributes.

FIGURE 3/I.210  
Examples of bearer service operation

**5.3.3** A teleservice provides the user with the possibility of various forms of applications (or teleservice applications) covering, for example:

- teleservice application involving two terminals providing the same teleservice attributes at both access points (3 or 5) (see Figure 4 a);
- teleservice application involving a terminal at one access point (3 or 5) and HLF functions located within the ISDN (see Figure 4 b);
- teleservice application involving terminals based on different teleservice attributes at each access point – in this case, the use of HLF functions in the ISDN is necessary (interworking situation) (see Figure 4 c);
- teleservice application involving a terminal at one access point (3 or 5) and a system providing HLF functions (see Figure 4 d);
- teleservice application involving two terminals at both access points (3 or 5) and an intervening system providing HLF functions (see Figure 4 e). In this case, teleservice attributes can be different at each terminal access point.

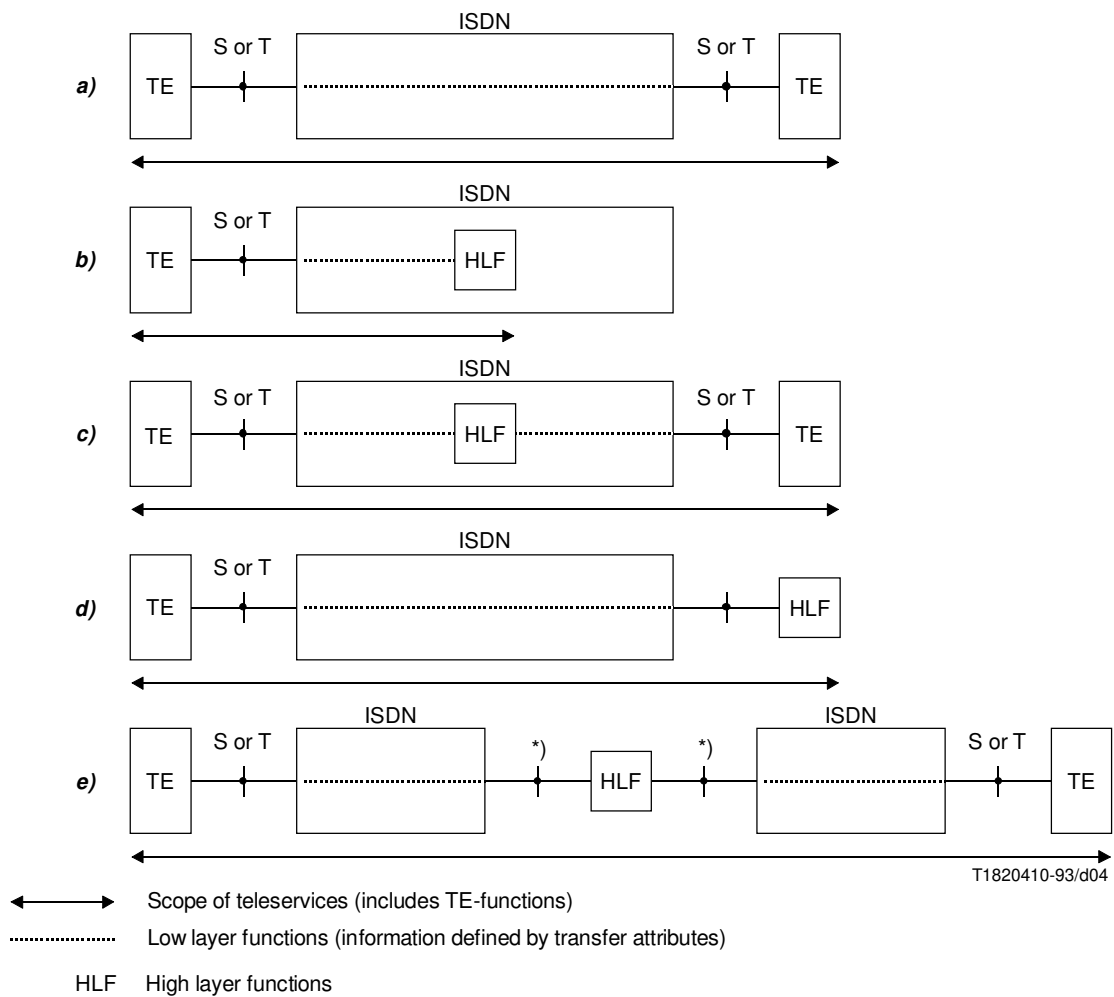

\*) Access point to be defined but not necessarily subject to CCITT Recommendations (See Recommendation I.324).

NOTE – Teleservices are accessed at access points 3 or 5 (see Figure 1).

FIGURE 4/I.210  
Examples of teleservice application

#### 5.4 Supplementary services supported by an ISDN

Supplementary services supported by an ISDN provide additional capabilities to be used with bearer services and teleservices. They cannot be offered to a customer as a stand alone service.

Supplementary services are characterized by a prose definition and description following the layout given in Annex A and a dynamic description applying the means given in Annex D.

The use of the attribute technique for supplementary services is for further study. The individual supplementary services are described in the I.250-Series Recommendations.

## **6 Provision of telecommunication services**

**6.1** A telecommunication service is provided by an Administration, and/or other service providers. Customer terminals and systems may be privately owned or provided by Administrations. Depending on the nature of customer ownership within the customer premises (TE or TE and NT2), a telecommunication service is provided at different access points.

**6.2** The provision of telecommunication services implies:

- subscription ensuring the basic service and possibly subscription to supplementary services;
- registration into a service directory in the case where demand services are used;
- compatibility between terminals;
- interworking capabilities (this point needs further study).

**6.3** The provision of individual bearer services is given in the I.230-Series Recommendations, the provision of individual teleservices is given in the I.240-Series Recommendations and the association of supplementary services to bearer services and teleservices is given in Recommendation I.250.

### **Annex A**

#### **Structure for prose service definition and description – Step 1.1 of description method (Recommendation I.130)**

(This annex forms an integral part of this Recommendation)

#### **A.1 Structure of prose service definition and description**

Prose service definition and description is the first step (1.1) of the stage 1 overall service description from the user's point of view (see Recommendation I.130). The prose definition of a telecommunication service will be structured as follows:

1. Definition
2. Description
  - 2.1 General description
  - 2.2 Specific terminology
  - 2.3 Qualifications
3. Procedures
  - 3.1 Provision/withdrawal
  - 3.2 Normal procedures
    - 3.2.1 Activation/deactivation/registration
    - 3.2.2 Invocation and operation
    - (3.2.3 Interrogation/editing)
  - 3.3 Exceptional procedures
    - 3.3.1 Activation/deactivation/registration
    - 3.3.2 Invocation and operation
    - (3.3.3 Interrogation/editing)
  - 3.4 Alternative procedures
    - 3.4.1 Activation/deactivation/registration
    - 3.4.2 Invocation and operation
    - (3.5 Verification)

4. Network capabilities for charging
5. Interworking requirements
6. Interaction with other supplementary services

#### NOTES

1 Where a particular section would not be appropriate for a particular service (basic or supplementary) “not applicable” appears in that section for that service. Some such items have been identified by paragraph numbering in parenthesis.

2 Where information contained under one item (e.g. 3.2.1) for a particular service is extensive, then this item may be further sub-divided under sub-headings as necessary.

3 In a Recommendation containing prose definitions and descriptions, an additional digit is prefixed to the above numbering structure to make the section numbering conform to the presentation rules laid out in Recommendation A.15.

## **A.2 Explanation of the terms and content of the items in the service prose definition and description**

### **1 Definition**

This clause provides a short description of the service in terms of the perceptions of the user receiving the service and any other users involved in the service.

### **2 Description**

This clause expands on the definition and summarizes the operation of the service in a generic form which does not constrain terminal or network design. It is intended to allow an understanding of the service without regard to implementation. It also includes any specific terminology used within the prose definition and description, and any qualifications. For basic services this clause details the applications which could utilize the service whilst for supplementary services this clause details their applicability to particular telecommunication services.

### **3 Procedures**

The overall operation of the service in its various states is described in this clause 3. These procedures relate to all actions between the user(s) and the network during the period that the service is available.

#### **3.1 Provision/withdrawal**

This clause describes the means by which the service is made available by the service provider, e.g. it may be generally available to all customers, or only be available to those customers who have made a prior arrangement.

#### **3.2 Normal procedures**

The paragraphs under this heading describe the normal procedures for activation, deactivation, registration, invocation and operation for the service as appropriate. This clause describes only the successful outcome of each procedure, and the procedures which are executed as a result of such successful outcomes. The procedures are described in a time-based sequence of events. They describe the interactions of the users involved in the service with the service provider and with each other which lead to, and are elements of, the successful operation of the service.

##### **3.2.1 Activation/deactivation/registration**

The procedures for activation, which is the operation of bringing the service into the “ready for invocation” state, and deactivation, which is the complementary action, are described in this clause. For some services there may be a specific user procedure to allow activation and deactivation as necessary, whilst for others the service is permanently activated on provision and thus no procedure is provided.

Registration describes the procedures by which any specific information, necessary for the successful operation of the supplementary service, is given to the network. The need to register information with the network, e.g. a forwarding number, only applies to certain supplementary services.

### **3.2.2 Invocation and operation**

This clause describes the procedures for invocation, which is the action and conditions under which the service is brought into operation; in the case of a supplementary service this may only be on a particular call. It should be noted that although a supplementary service may be activated, it may not necessarily be invoked on all calls. (Invocation takes place either subsequent to or simultaneously with activation.)

In the case of basic services this clause describes the events, perceived at the service access point, during the establishment, information transfer and clearing phases.

Operation is the procedure which occurs once a service has been invoked. In the case of a supplementary service this is described in terms of the way in which the supplementary service modifies/enhances the network's treatment of a call. This description gives details of the significant actions of the network, treated in principle as a single entity, and the perception of the users involved on the call. It includes details of the information exchanged between the network and relevant users and the indications given to each user, by the network, concerning the states of the call.

### **3.2.3 Interrogation/editing**

Interrogation is the facility which enables a served user to determine, from the service provider, the current status of a particular service. Whether this facility is provided for the service being described, and if so, the procedures that accompany it, are detailed in this clause.

Editing describes the process whereby any registered information (see clause 3.2.1 under this A.2) specific to a service may be erased or modified by the served user.

## **3.3 Exceptional procedures**

The paragraphs under this heading describe, for each of the items shown under 3.2 of A.2, the exceptional procedures which result in an unsuccessful outcome of the call. Included within this description are the details for such situations as invalid user action and the handling of certain network and interface conditions. For the case of basic services this includes the handling of such network conditions as congestion.

## **3.4 Alternative procedures**

The subsections under this heading describe any alternative procedures, where available, for each of the items shown under 3.2 of A.2. These either allow an alternative way of activating or invoking the service, or detail a possible alternative treatment of the call by the network.

## **3.5 Verification**

This clause describes the facilities that are provided by the network to enable the subscriber to verify the operation of the service once it has been activated. Not all services allow provision for verification of the operation of the service.

## **4 Networking capabilities for charging**

This clause details only those charging aspects specific to the service in question and includes, where necessary, both static (subscription) and dynamic (call related) aspects.

## **5 Interworking requirements**

This clause describes special aspects of the individual service, if the service is used in a connection which exists partly inside and partly outside a given ISDN, or which, for certain operational aspects, routes through more than one ISDN.

## **6 Interaction with other supplementary services**

This clause only applies in the case of supplementary services and describes all interactions of the supplementary service being described with other supplementary services as far as they have been identified and which are relevant for standardization.

For example, for some supplementary service pairs there is no interaction as the two supplementary services are not permitted to be both in operation at the same time. For other pairs, one or both supplementary services may be modified whilst the pair of services are in operation simultaneously.

It is recognized that although the layout, and the detailed work to date, has only dealt with the interactions between two supplementary services, further work is necessary on combinations of more than two supplementary services.

## Annex B

### List of attributes and their possible values for describing bearer services – Step 1.2 of description method (Recommendation I.130)

(This annex forms an integral part of this Recommendation)

#### B.1 Framework for the static description of bearer services supported by an ISDN

Static description of the service using attributes is the second step (1.2) of the stage 1 overall service description from the user's point of view (see Recommendation I.130). These attributes are described and defined in Recommendation I.140. Attributes to describe bearer services are intended to be independent and are grouped into three categories:

- i) information transfer attributes which characterize the network capabilities for transferring information from one S- or T-reference point to one (or more) other S- or T-reference point(s), corresponding to access points 2 and 1 as defined in Recommendation I.210;
- ii) access attributes which describe the means for accessing network functions or facilities as seen at one S- or T-reference point; and
- iii) general attributes which deal with the service in general.

Figure B.1 shows the relation between the groups of attributes and their fields of applicability. Subclause B.2 gives the list of the attributes. For the definitions and possible values of these attributes, see Recommendation I.140.

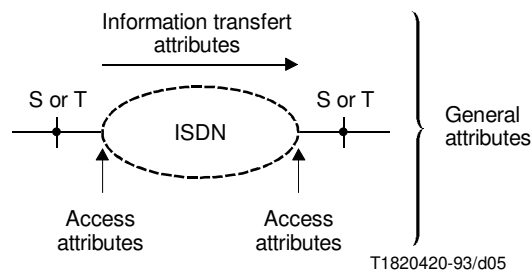

FIGURE B.1/I.210

**Relationship between the groups of attributes and fields of applicability**

#### B.2 List of bearer service attributes

##### B.2.1 Service attributes for 64 kbit/s-ISDN bearer services

###### *Information transfer attributes*

1. Information transfer mode
2. Information transfer rate



3. Information transfer capability
4. Structure
5. Establishment of communication
6. Symmetry
7. Communication configuration

*Access attributes* (see Note)

8. Access channel and rate
9. Access protocol
  - 9.1 Signalling access protocol layer 1
  - 9.2 Signalling access protocol layer 2
  - 9.3 Signalling access protocol layer 3
  - 9.4 Information access protocol layer 1
  - 9.5 Information access protocol layer 2
  - 9.6 Information access protocol layer 3

*General attributes*

10. Supplementary services provided
11. Quality of Service
12. Interworking capabilities
13. Operational and commercial aspects

NOTE – Different access attributes may apply at each of the (two or more) network interfaces involved in the use of a bearer service.

Table B.1 presents a list of possible values for each attribute. Where options exist for a given attribute, the selection is subject to agreement between the customer and the Administration.

According to this Recommendation the bearer capability defines the technical features of a bearer service as they appear to the user at the SART reference point. The bearer capability is characterized by information transfer and access attributes. A bearer capability is associated with every bearer service.

### **B.2.2 Service attributes for broadband ISDN mono/media and multimedia bearer services**

*General descriptions of ATM related attributes*

In the following, additional sub-attributes characterizing the service requirements on ATM-based networks are described.

Broadband bearer services may be associated to bearer service sub-categories characterized by the values of attributes Nos. 1.1 to 1.2 (see Table 2) in accordance with the classification of the AAL functions described in Recommendation I.362.

- *Information transfer mode* – This attribute describes the operational mode for transferring (i.e. transporting and switching) user information through the ISDN (e.g. ATM).

For a clearer characterization of the services' bearer capabilities, four sub-attributes should be added to this attribute:

- *Connection mode* – Describing a connection oriented or connectionless transfer;
- *Traffic type* – Describing bit streams with constant (CBR) or variable bit rates (VBR) supported by the service in one or several VC or a VP (see 3.1);
- *Timing end-to-end* – Describing the timing relation between source and destination of signals to be transferred via one or several VC or a VP. End-to-end timing is necessary for real-time information, e.g. video signals;

TABLE B.1/I.210

## Values for each bearer service attribute

Attributes <sup>a)</sup>	Possible values of attributes									
<i>Information transfer attributes</i>										
1. Information transfer mode	Circuit							Packet		
2. Information transfer rate	Bit rate (kbit/s)							Throughput		
	64	2 × 64	384	1536	1920	Other values for further study		Options for further study		
3. Information transfer capability	Unrestricted digital information		Speech	3.1 kHz audio	7 kHz audio	15 kHz audio	Video	Others for further study		
4. Structure	8 kHz integrity		Service data unit integrity <sup>b)</sup>			Unstructured		TSSI <sup>c)</sup>	RDTD <sup>d)</sup>	
5. Establishment of communication <sup>e)</sup>	Demand		Reserved			Permanent				
6. Symmetry	Unidirectional		Bidirectional symmetric			Bidirectional asymmetric				
7. Communication configuration	Point-to-point		Multipoint			Broadcast <sup>f)</sup>				
<i>Access attributes</i>										
8. Access channel and rate	D (16)	D (64)	B	H <sub>0</sub>	H <sub>11</sub>	H <sub>12</sub>	Others for further study			
9.1 Signalling access protocol layer 1	Rec. I.430/ Rec. I.431	Rec. I.461	Rec. I.462	Rec. I.463 (Rec. V.120) Rec. I.465		Others for further study				
9.2 Signalling access protocol layer 2	Rec. I.440/ Rec. I.441		Rec. I.462	Rec. X.25		Others for further study				
9.3 Signalling access protocol layer 3	Rec. I.450/ Rec. I.451		Rec. I.461	Rec. I.462	Rec. X.25	Rec. I.463	Others for further study			
9.4 Information access protocol layer 1	Rec. I.430/ Rec. I.431	Rec. I.460 <sup>g)</sup>	Rec. I.461	Rec. I.462	Rec. I.463	(Rec. V.120) Rec. I.465	Rec. G.711	Rec. G.722	Others for further study	
9.5 Information access protocol layer 2	HDLC LAPB	I.440/ I.441	Rec. X.25	Rec. I.462			Others for further study			
9.6 Information access protocol layer 3 <sup>h)</sup>	T.70-3		Rec. X.25	Rec. I.462			Others for further study			
<i>General attributes</i>										
10. Supplementary services provided	Under study									
11. Quality of service										
12. Interworking capabilities										
13. Operational and commercial aspects										
<sup>a)</sup> The attributes are intended to be independent of each other.										
<sup>b)</sup> The need for a “data sequence integrity” attribute is for further study.										
<sup>c)</sup> Time slot sequence integrity (TSSI).										
<sup>d)</sup> Restricted differential time delay (RDTD).										
<sup>e)</sup> A definition of the establishment of communication is given in Recommendation I.140.										
<sup>f)</sup> The characterization of the information transfer configuration attribute “broadcast” is for further study.										
<sup>g)</sup> The inclusion of Recommendation I.460 implies the support of non-ISDN CCITT standardized services (e.g. at X.1 rate). The necessary user-network signalling is provided in Recommendation I.451.										
<sup>h)</sup> The use of Recommendation I.451 as an information access protocol is for further study.										

- *VCI transparency* – This sub-attribute is relevant for virtual path (VP) bearer services. Its value describes the unrestricted use and multiplexing of virtual channels within the VP by the users.

Attribute information transfer rate: the bit rate of VBR services available to the user for the transfer of user's information via one or several VC or a VP are mainly described by two parameters which should be defined as sub-attributes:

- *Peak bit rate* – the maximum bit rate offered to the user for a given time period (to be defined) for the transfer of a bursty signal:
- *Mean bit rate* – the average bit rate available to the user for a given time period (to be defined).

The bit rate offered by a CBR service will be characterized by the sub-attribute peak bit rate.

The source traffic may be further characterized by additional attributes e.g. "burstiness" and "peak duration". The definitions of those attributes are for further study.

Access protocols: the access protocol attribute should be amended by sub-attributes describing the ATM layer and ATM adaptation layer access protocols for signalling, OAM and user information:

- Signalling access protocol – Physical layer
- Signalling access protocol – ATM layer
- Signalling access protocol – ATM adaptation layer (AAL)
- Information access protocol – Physical layer
- Information access protocol – ATM layer
- Information access protocol – ATM adaptation layer (AAL)

#### *Information transfer attributes*

1. Information transfer mode
  - 1.1 Connection mode
  - 1.2 Traffic type of virtual channels or virtual path<sup>1)</sup>
  - 1.3 Timing end-to-end of virtual channels or virtual path<sup>1)</sup>
  - 1.4 VCI transparency (for virtual path services)
2. Information transfer rate: peak bit rate, mean bit rate for virtual channels or virtual path<sup>1)</sup>
3. Information transfer capability of virtual channels or virtual path<sup>1)</sup>
4. Structure of virtual channels or virtual path<sup>1)</sup>
5. Establishment of communication
6. Symmetry of virtual channels or virtual path<sup>1)</sup>
7. Communication configuration

#### *Access attributes*

8. Access channels and rates
  - 8.1 For user information
    - 8.1.1 Number of channels
    - 8.1.2 Type of channels
  - 8.2 For signalling

---

<sup>1)</sup> Virtual path for virtual path bearer services is for further study.

9. Access protocols
  - 9.1 Signalling access protocol – Physical layer
  - 9.2 Signalling access protocol – ATM layer
  - 9.3 Signalling access protocol – ATM adaptation layer (AAL)
  - 9.4 Signalling access protocol – Layer 3 (above AAL)
  - 9.5 Information access protocol – Physical layer
  - 9.6 Information access protocol – ATM layer
  - 9.7 Information access protocols – ATM adaptation layer (AAL) for virtual channels or virtual path<sup>1)</sup>
  - 9.8 Information access protocols-layers above AAL for virtual channels or virtual path<sup>2)</sup>

*General attributes*

10. Supplementary services provided
11. Quality of Service of virtual channels or virtual path (sub-attributes are for further study)<sup>2)</sup>
12. Interworking capabilities
13. Operational and commercial aspects

NOTE – This attribute may have multiple values when more than one virtual channel (VC) or virtual path (VP) is used by the service.

TABLE B.2/I.210

**Possible values for service attributes of mono/media and multimedia B-ISDN bearer services**

Bearer service attributes	Possible values of attributes for B-ISDN services					
<i>Information transfer attributes</i>						
1. Information transfer mode	ATM					
1.1 Connexion mode	Connection oriented			Connectionless		
1.2 Traffic type (Note 6)	Constant bit rate (CBR)	Variable bit rate (VBR)	User defined	Others for further study		
1.3 Timing end-to-end (Note 6)	Required	Not required				
1.4 VCI transparency	Transparent	Non transparent				
2. Information transfer rate: Peak bit rate, mean bit rate (Notes 1, 5 and 6)	Specific bit rates for CBR traffic are for further study		VBR for further study			Others for further study
3. Information transfer capability (Note 6)	Unrestricted	Speech		3.1 kHz audio	7 kHz audio	
4. Structure (Note 6)	Unstructured	8 kHz integrity (Note 2)	ATM-SDU integrity (Note 3)	AAL-SDU integrity	CL-SDU integrity (Note 4)	Others for further study
5. Establishment of communication	As in the Table B.1					
6. Symmetry (Note 6)						
7. Communication configuration						

<sup>2)</sup> Virtual path for virtual path bearer services is for further study.

TABLE B.2/I.210 (end)

**Possible values for service attributes of mono/media and  
multimedia B-ISDN bearer services**

Bearer service attributes	Possible values of attributes for B-ISDN services					
<i>Access attributes</i>						
8. Access channels						
8.1 For user information						
8.1.1 Number of channels						
8.1.2 Type of channels	VC	VP				
8.2 For signalling	Signalling virtual channel					
9. Access protocols						
9.1 Signalling access protocol – physical layer	Rec. I.432	Others for further study				
9.2 Signalling access protocol – ATM layer	Recs. I.150 and I.361	Others for further study				
9.3 Signalling access protocol – ATM adaptation layer (AAL)	For further study					
9.4 Signalling access protocol – layer 3 (above AAL)	Recs. Q.930/Q.931 (to be amended for broadband)				Others for further study	
9.5 Information access protocol – physical layer	Rec. I.432	Others for further study				
9.6 Information access protocol – ATM layer	Recs. I.150, I.361		Others for further study			
9.7 Information access protocols – ATM adaptation layer (AAL) (Note 6)	Recs. I.362, I.363 – Type 1	Recs. I.362, I.363 – Type 2	Recs. I.362, I.363 – Type 3	Recs. I.362, I.363 – Type 4	User defined	Others for further study
9.8 Information access protocols – layer 3 above AAL (Note 6)	User defined		Others for further study			
<i>General attributes</i>						
10. Supplementary services	64 kbit/s-ISDN supplementary services when supporting 64 kbit/s-ISDN services				Supplementary services for B-ISDN services	
11. Quality of Service (sub-attributes are for further study)	See Rec. I.356					
12. Interworking capabilities	CO-, CL-broadband- and 64-kbit/s-bearer services in ISDN and other networks					
13. Operational and commercial aspects	For further study					
<b>NOTES</b>						
1 As described in Recommendations I.432 and I.211, the maximum service bit rate at the 155.52 Mbit/s interface will be less than 135.631 Mbit/s. The maximum service bit rate supported by the 622.08 Mbit/s interface is for further study. The actual value depends on the capacity required by signalling, OAM, and ATM adaptation overheads (for further study). Also granularity of the actual service bit rates offered by the network is for further study.						
2 This will be used for 64 kbit/s-ISDN circuit mode bearer services.						
3 i.e. 48-octet integrity.						
4 Structure & function of CL-SDU is for further study.						
5 For CBR services: the mean bit rate is equal to the peak bit rate.						
6 This attribute may have multiple values when more than one VC or VP offered by the service.						

## Annex C

### List of attributes and their possible values for describing teleservices – Step 1.2 of description method (Recommendation I.130)

(This annex forms an integral part of this Recommendation)

#### C.1 Framework for the static description of teleservices supported by an ISDN

A static description of the service using attributes is the second step (step 1.2) of the stage 1 overall service description from the user's point of view (see Recommendation I.130). These attributes are described and defined in Recommendation I.140.

Attributes to describe teleservices supported by an ISDN are intended to be largely independent. They are grouped into three categories:

- a) low layer attributes
  - information transfer attributes;
  - access attributes;
- b) high layer attributes;
- c) general attributes.

NOTE – Teleservices generally make use of underlying lower layer capabilities of bearer services specified in the I.230-Series Recommendations. However, where teleservices are provided by a single Administration, ROAs or other service providers, the combination of values of lower layer attributes applicable to specific teleservices may not necessarily be identical to any of those identified for the bearer services appearing in the I.230-Series Recommendations.

Figure C.1 shows the relationship between the different categories of service attributes and their scope within a teleservice.

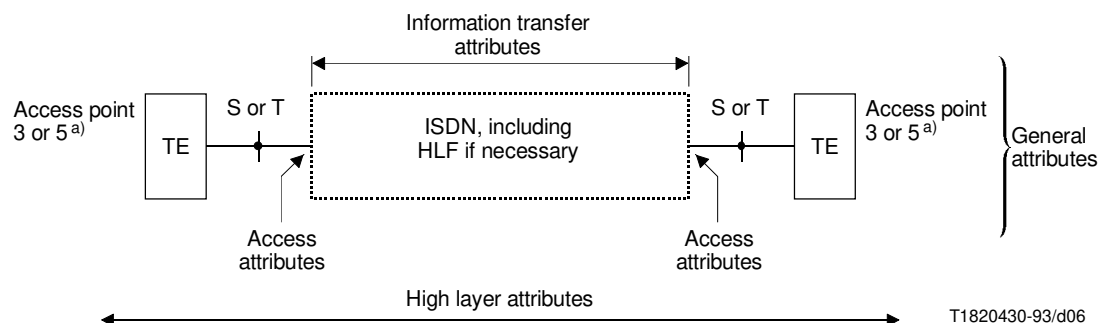

a) See Figure 1.

FIGURE C.1/I.210

Relationship between the categories of service attributes  
and their scope with a teleservice

#### C.2 List of the teleservice attributes

##### C.2.1 Service attributes for 64 kbit/s ISDN teleservices

*Low layer attributes*

*Information transfer attributes*

1. Information transfer mode
2. Information transfer rate

3. Information transfer capability
4. Structure
5. Establishment of communication
6. Symmetry
7. Communication configuration

*Access attributes*

8. Access channel and rate
9. Access protocol
  - 9.1 Signalling access protocol layer 1
  - 9.2 Signalling access protocol layer 2
  - 9.3 Signalling access protocol layer 3
  - 9.4 Information access protocol layer 1
  - 9.5 Information access protocol layer 2
  - 9.6 Information access protocol layer 3

*High layer attributes*

10. Type of user information
11. Layer 4 protocol functions
12. Layer 5 protocol functions
13. Layer 6 protocol functions
  - Resolution (if applicable)
  - Graphic mode (if applicable)
14. Layer 7 protocol functions
  - TE-to-TE protocol functions [if applicable (see Note)]
  - TE-to-HLF protocol functions [if applicable (see Note)]

*General attributes*

15. Supplementary services provided
16. Quality of Service
17. Interworking capabilities
18. Operational and commercial

NOTE – These attribute values are shown in order to give an example of a description of a teleservice application involving terminals at both access points (3 or 5) and an intervening system providing HLF functions (see diagrams *c* and *e* of Figure 4). A specific teleservice attribute description for this case is for further study.

Table C.1 presents a list of possible values for each service attribute. Where optional values of given attributes are offered, their selection is subject to agreement between the customer and service provider.

NOTE – Different access attributes may apply at each of the (two or more) network interfaces involved in the use of a bearer service.

Table C.1 presents a list of possible values for each attribute. Where options exist for a given attribute, the selection is subject to agreement between the customer and the Administration.

Table C.2 presents a list of possible values for service attributes of B-ISDN bearer services.

According to Recommendation I.210 the bearer capability defines the technical features of a bearer service as they appear to the user at the S- or T-reference point. The bearer capability is characterized by information transfer and access attributes. A bearer capability is associated with every bearer service.

TABLE C.1/I.210

## Possible values for each teleservice attribute

Attributes <sup>a)</sup>	Possible values of attributes							
<i>Information transfer attributes</i>								
1. Information transfer mode	Circuit						Packet	
2. Information transfer rate	Bit rate (kbit/s)						Throughput	
	64	Other values for further study					Options for further study	
3. Information transfer capability	Unrestricted digital information	Speech	3.1 kHz audio	7 kHz audio	Others for further study			
4. Structure	8 kHz integrity	Service data unit integrity			Unstructured	Others for further study		
5. Establishment of communication <sup>b)</sup>	Demand	Reserved			Permanent			
6. Symmetry	Unidirectional	Bidirectional symmetric			Bidirectional asymmetric			
7. Communication configuration	Point-to-point	Multipoint			Broadcast <sup>c)</sup>			
<i>Access attributes</i>								
8. Access channel and rate	D (16)		D (64)		B		Others for further study	
9.1 Signalling access protocol layer 1	Rec. I.430/ Rec. I.431	Rec. I.461	Rec. I.462	Rec. I.463	Rec. I.465 (Rec. V.120)	Others for further study		
9.2 Signalling access protocol layer 2	Rec. I.440/ Rec. I.441		Rec. I.462	Rec. X.25	Others for further study			
9.3 Signalling access protocol layer 3	Rec. I.450/ Rec. I.451		Rec. I.461	Rec. I.462	Rec. X.25	Rec. I.463	Others for further study	
9.4 Information access protocol layer 1	Rec. I.430/ Rec. I.431	Rec. I.460	Rec. I.461 (Rec. X.30)	Rec. I.462 (Rec. X.31)	Rec. I.463 (Rec. V.110)	Rec. I.465 (Rec. V.120)	Rec. G.711	Others for further study
9.5 Information access protocol layer 2	HDLC LAPB		Rec. I.440/ Rec. I.441	Rec. X.75 SLP	Rec. X.25 LAPB	Others for further study		
9.6 Information access protocol layer 3	ISO 8208 <sup>d)</sup> (Rec. X.25 PLP)			Rec. X.25 PLP		Others for further study		



TABLE C.1/I.210 (end)

**Possible values for each teleservice attribute**

Attributes <sup>a)</sup>	Possible values of attributes								
10. Type of user information	Speech (telephony)	Sound	Text (teletex)	Facsimile (telefax 4)	Text-facsimile (mixed mode)	Videotex	Video	Text interactive (telex)	Other
11. Layer 4 protocol	Rec. X.224			Rec. T.70		Others for further study			
12. Layer 5 protocol	Rec. X.225			Rec. T.62		Others for further study			
13. Layer 6 protocol	T.400-Series Recs.		Rec. G.711	Rec. T.61	Rec. T.6	Others for further study			
Resolution <sup>e) f)</sup>	200 ppi		240 ppi	300 ppi	400 ppi	Others for further study			
Graphic mode <sup>f)</sup>	Alpha-mosaic		Geometric	Photographic		Others for further study			
14. Layer 7 protocol	Rec. T.60			T.500-Series		Others for further study			
<i>General attributes</i>	Under study								
SLP Single link protocol PLP Packet layer protocol ppi Picture elements per inch a) The attributes are intended to be independent of each other. b) A definition of the establishment of communication is given in Recommendation I.140. c) The characterization of the information transfer configuration attribute "broadcast" is for further study. d) For those teleservices that use circuit mode bearer capability X.25 PLP description is as per ISO 8208. e) These attribute values are mentioned in order to give an example of a specific presentation description of characteristics such as coding of the user information, resolution, and graphic mode. Attribute values for other presentation characteristics are for further study. f) If applicable.									

**C.2.2 Service attributes for broadband ISDN mono/media and multimedia teleservices****Multimedia related attributes**

Multimedia services support the transfer (and in some cases also the retrieval, messaging, or distribution) of several types of information (service components). The service characteristics are described by the values of their attributes. These are the service dependent attributes (bearer service and teleservice attributes) describing the means of communication offered by the service, and the service component attributes describing the characteristics of the types of information to be transferred such as video, audio, data, etc. The service (dependent) attribute values are applicable for all the communication relations of the service including all types of information supported by the service. The service component attribute values are dedicated to a specific type of information independent from the service. The service component descriptions are also part of the descriptions of teleservices providing the transfer of such information types.

In the following additional or modified service attributes and service component attributes are described characterizing the information transfer capabilities of multimedia (and partly also mono/media) services (via virtual channels or virtual path of the B-ISDN).

TABLE C-2/I.210

Possible values for service attributes of B-ISDN teleservices <sup>a)</sup>

Teleservice attributes	Possible values of attributes for B-ISDN services			
<i>Information transfer attributes</i>				
1. Information transfer capability, Service components				
1.1 Mandatory service components	High quality video	High quality audio	Unrestricted digital information	Others for further study
1.2 Optional service components	User-to-user messages: voice, text, graphics, still images, etc.		Others for further study	
2. Information transfer mode	ATM			Others for further study
2.1 Connection mode	Connection oriented			
2.2 Traffic type (service specific) (Note 4)	Constant bit rate (CBR)	Variable bit rate (VBR)		
2.3 Timing end-to-end (service specific) (Note 4)	Required		Not required	
3. Information transfer rate (service specific): Peak bit rate, mean bit rate (Notes 1 and 4)	Specific bit rates for CBR traffic for further study		VBR for further study	
4. Structure (Service specific) (Note 4)	As in Table C.1	TSSI	RDTD between VCs (Note 3)	Others for further study
5. Establishment of communication	As in Table C.1			
6. Symmetry (Note 5)				
7. Communication configuration				
<i>Access attributes</i>				Others for further study
8. Access channels and rates 8.1 For user information	Virtual channels (VC) for service components (SC) Virtual channel connections via the 155.52 Mbit/s or 622.08 Mbit/s interfaces. The maximum service bit rates are for further study (Notes 2 and 6)			
8.2 For signalling	Signalling virtual channel			
9. Access protocols				
9.1 Signalling access protocol – physical layer	Rec. I.432	Others for further study		
9.2 Signalling access protocol – ATM layer	Recs. I.150 and I.361		Others for further study	
9.3 Signalling access protocol – ATM adaptation layer (AAL)	For further study			

TABLE C-2/I.210 (end)

**Possible values for service attributes of B-ISDN teleservices <sup>a)</sup>**

Teleservice attributes	Possible values of attributes for B-ISDN services				
9.4 Signalling access protocol – layer 3 (above AAL)	Rec. Q.930/Q.931 (to be amended for broadband)			Others for further study	
9.5 Information access protocol – physical layer	Rec. I.432	Others for further study			
9.6 Information access protocol – ATM layer	Recs. I.150 and I.361		Others for further study		
9.7 Information access protocols – ATM adaptation layer (AAL) (Note 6)	Recs. I.362, I.363 – Type 1	Recs. I.362, I.363 – Type 2	Recs. I.362, I.363 – Type 3	Recs. I.362, I.363 – Type 4	Others for further study
<i>General attributes</i>					
10. Supplementary services provided	As for telephony so far as applicable for conversational broadband services		Others for further study		
11. Quality of service (service specific) (sub-attributes are ffs.) (Note 4)	Under study				
12. Interworking capabilities	With other services supporting the same service components				
13. Operational and commercial aspects	For further study				
<sup>a)</sup> This table could cover both monomedium and multimedia services. NOTES 1 For CBR services, the mean bit rate is equal to the peak bit rate. 2 As described in Recommendations I.432 and I.211, the maximum service bit rate at the 155.52 Mbit/s interface will be less than 135.631 Mbit/s. The maximum service bit rate supported by the 622.08 Mbit/s interface is for further study. The actual value depends on the capacity required by signalling, OAM, and ATM adaptation overheads (for further study). Also granularity of the actual service bit rates offered by the network is for further study. 3 This may also be described as a QOS subattribute value. 4 This attribute may have multiple values when than one VC or VP are offered by the service. 5 To be described separately for each service component. 6 The exact mapping of VCIs to service component's is for further study.					

**Service attributes**

Multimedia bearer services and teleservices via an ATM-based network may offer several virtual channels (VC), one VC for each service component. Adapted to the special requirements of the service components to be supported, each of the VC may have particular characteristics described by particular attribute values. So, for the consideration of multimedia aspects most of the service attributes should be amended by sub-attributes describing the characteristics of the individual VC or service component where applicable.

Mono/media services and multimedia services offering only one VC or virtual path (VP) for the unrestricted use including multiplexing by the user can also be described using the same description method without VC specific sub-attributes.

### **Information transfer capabilities, service components (for teleservices)**

This is a modified teleservice attribute describing by its sub-attributes the types of information, i.e. service components, which are mandatorily or optionally supported by this service. Two groups of sub-attributes are proposed:

- mandatory service components;
- optional service components.

The values of these sub-attributes contain the names of the service components, e.g. voice, audio, data, video. These service components are characterized by their attribute values.

### **Information transfer capability (for bearer services)**

By this attribute the transfer capabilities (unrestricted or dedicated to specific information types as defined in this Recommendation and in Recommendation I.140) of one or several VC or a VP are described.

### **Structure (service specific)**

The attribute values characterize the information structure to be preserved when transporting the information via the network. An individual structure may be preserved for each VC or a global structure for all VCs or a VP covering the requirements of all service components supported by the service.

### **Symmetry**

The values of this attribute (defined in Recommendation I.140) characterize for each information type (service component) supported by this service the direction of the information flow depending on the type of communication. The information flow of each service component in one or several VC or a VP may be, e.g. bidirectional when used in an interactive service or unidirectional in a distribution service.

### **Access channel and rate**

Two sub-attributes should be added to describe the access channels and their bit rates for user information and signalling separately. A multimedia service may offer one individual virtual channel for each type of user information or one common virtual for all types of user information. For teleservices, also the association of the service components to the virtual channels should be described.

### **Quality of Service (service specific)**

The value of this attribute characterizes either the overall QOS covering the individual QOS requirements of all service components of this service or individual QOS for each virtual channel depending on the service component to be transferred. The QOS sub-attributes to describe the overall QOS or the VC specific QOS are under study.

### **Low layer attributes**

#### *Information transfer attributes*

1. Information transfer capability, service components
  - Mandatory service components<sup>3)</sup>
  - Optional service components<sup>3)</sup>
2. Information transfer mode
  - 2.1 Connection mode
  - 2.2 Traffic type (service specific<sup>3)</sup>)
  - 2.3 Timing end-to-end (service specific<sup>3)</sup>)

---

<sup>3)</sup> This attribute may have multiple values when more than one virtual channel (VC) or service component (SC) are used/supported by the service.

3. Information transfer rate (service specific): Peak bit rate, mean bit rate<sup>4)</sup>
4. Structure (service specific)<sup>4)</sup>
5. Establishment of communication
6. Symmetry of service components<sup>4)</sup>
7. Communication configuration

#### *Access attributes*

8. Access channels and rates
  - 8.1 For user information, service components<sup>4)</sup>
  - 8.2 For signalling
9. Access protocols
  - 9.1 Signalling access protocol – Physical layer
  - 9.2 Signalling access protocol – ATM layer
  - 9.3 Signalling access protocol – ATM adaptation layer (AAL)
  - 9.4 Signalling access protocol – Layer 3 (above AAL)
  - 9.5 Information access protocol – Physical layer
  - 9.6 Information access protocol – ATM layer
  - 9.7 Information access protocol – ATM adaptation layer (AAL)<sup>4)</sup>

#### *General attributes*

10. Supplementary services provided
11. Quality of Service (service specific) (sub-attributes are for further study)<sup>4)</sup>
12. Interworking capabilities
13. Operational and commercial aspects

### **C.3 List of the service component attributes**

#### **Service component attributes**

These attributes describe by their values the specific characteristics and network requirements of one service component independent of the communication relations and support of a service (see Table C.3).

The service component (SC) attributes with information type specific values are

- traffic type (SC specific) characterizing the bit stream of the individual information type;
- timing end-to-end (SC specific) characterizing the information type specific time relations between source and destination;
- information transfer rate (as described in 2.2, but with values required by the individual information type);
- structure (as defined in this Recommendation and Recommendation I.140) required by the individual SC;
- layer 3 to 7 protocol functions as applicable for the SC;
- quality of Service (information type specific QOS, see also service specific QOS in 3.1.6).

The same service component can be used by different services. The service independent standardization of the service components provides compatibility between services offering the same service component(s).

---

<sup>4)</sup> This attribute may have multiple values when more than one virtual channel (VC) or service component (SC) is used/supported by the service.

TABLE C.3/I.210

**Possible values for service component attributes**

Service component (SC) attributes	Possible values of attributes			
<i>Information transfer attributes</i>				
1. Traffic type (SC specific)	Constant bit rate (CBR)		Variable bit rate (VBR)	
2. Timing end-to-end (SC specific)	Required		Not required	
3. Information transfer rate (SC specific)				
3.1 Peak bit rate	Specific bit rates for further study		For further study	Others for further study
3.2 Mean bit rate	(Note)		For further study	
4. Structure (SC specific) (sub-attributes are for further study)	As in Table C.1	TSSI	Others for further study	
<i>Attributes of layers above AAL</i>				
5. Layer 3 protocol functions	For further study (dependent on information type)			
6. Layer 4 protocol functions	Under study (dependent on information type)			
7. Layer 5 protocol functions				
8. Layer 6 protocol functions				
9. Layer 7 protocol functions				
<i>General attribute</i>				
10. Quality of Service (SC specific) (sub-attributes are for further study)	7 kHz audio mono/stereo	15 kHz audio mono/stereo	Existing TV (625-line or 525-line) standards	Others for further study
NOTE – For CBR services, the mean bit rate is equal to the peak bit rate.				

*Information transfer attributes*

1. Traffic type (service component specific)
2. Timing end-to-end (service component specific)
3. Information transfer rate (service component specific)
  - 3.1 Peak bit rate
  - 3.2 Mean bit rate
4. Structure (service component specific)

*Attributes of layers above AAL*

5. Layer 3 protocol functions

*High layer attributes*

6. Layer 4 protocol functions
7. Layer 5 protocol functions

8. Layer 6 protocol functions
  - Resolution (if applicable)
  - Graphic mode (if applicable)
9. Layer 7 protocol functions
  - TE-to-TE protocol functions [if applicable (see Note to attribute list in C.2)]
  - TE-to-HLF protocol functions [if applicable (see Note to attribute list in C.2)]

*General attribute*

10. Quality of Service (service component specific) (sub-attributes are for further study)

## **Annex D**

### **Dynamic description of the service using graphic means – Step 1.3 of description method (Recommendation I.130)**

(This annex forms an integral part of this Recommendation)

#### **D.1 Introduction**

Dynamic description of the service using graphic means is the third step (1.3) of the stage 1 overall service description from the user's point of view (see Recommendation I.130).

The dynamic description of a service contains all the information that is sent and received by the user from activation/invoke of the service to completion of the service. The information is presented in the form of an overall specification and description language (SDL) diagram or state transition diagrams.

NOTE – Currently, state transition diagrams are not used for the dynamic descriptions of services.

An overall SDL diagram shows the flow of events and states within the service, in a time-sequenced format, and identifies all possible actions relevant to the service as perceived by the user. It treats the network as a single entity, that is, no information flows between nodes within the network are considered.

SDL diagrams, drawn according to the principles laid down in Recommendation Z.100, are included in step 1.3 in order to help to clarify and support the processing and information flows necessary for each service.

#### **D.2 Overall specifications and description language (OSDL) diagrams**

In this third step of stage 1 each service state is shown in conjunction with all the external or internal actions which cause state changes. The actions may be inputs from users or the outcome of an internal process. Ideally all situations are included in a single diagram although the diagram may have to be distributed over more than one document because of its complexity.

The symbols used in OSDL diagrams and their meanings are as follows:

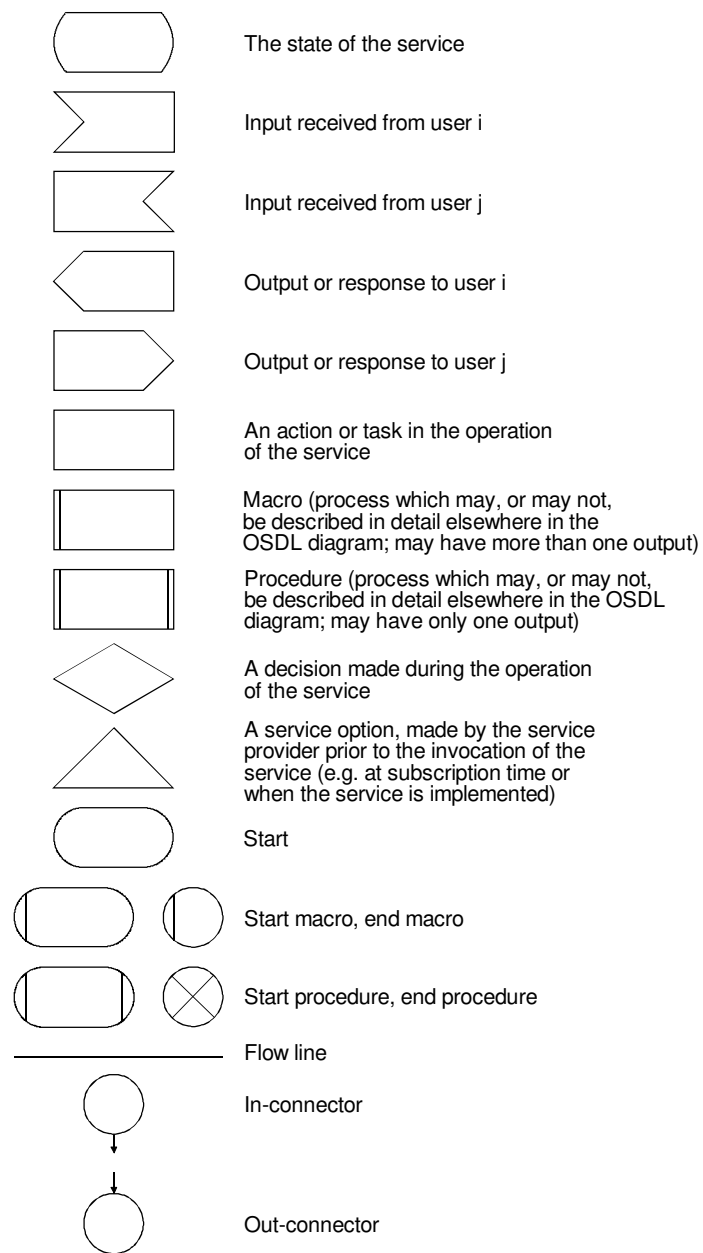

T1820440-93/d07