

# NUTS AND VOLTS

www.nutsvolts.com  
January 2013

EVERYTHING FOR ELECTRONICS

## Build Your Own GRAVIMETER

And measure differences in the Earth's gravitational field.

**Try The New!**  
**Nuts & Volts**  
**Mobile App**  
Available For  
iOS - Android  
Kindle Fire



### ◆ Inverting DC-DC Converter

Put +V in and get -V out.

### ◆ The Sirius Metronome

Impressive features that even expensive commercial units can't provide.

# Now with 32MB Flash and 64MB RAM!

## MOD54415 Core Module

32-bit 250 MHz processor  
64MB DDR2 RAM  
32MB flash  
10/100 Mbps Ethernet  
44 general purpose I/O  
Eight UARTs  
Five I2C  
Two CAN  
3 SPI  
1-Wire®  
5 pulse width modulators (PWM)  
SSI  
MicroSD flash card  
8 analog to digital converters (ADC)  
Two digital to analog converters (DAC)

## NANO54415 Core Module

32-bit 250 MHz processor  
64MB DDR2 RAM  
8MB flash  
10/100 Mbps Ethernet  
30 general purpose I/O  
Eight UARTs  
Four I2C  
Two CAN  
3 SPI  
1-Wire®  
8 pulse width modulators (PWM)  
SSI  
MicroSD flash card ready  
6 analog to digital converters (ADC)  
Two digital to analog converters (DAC)



NANO54415

\$69<sup>00</sup>  
Qty. 100



MOD54415

\$89<sup>00</sup>  
Qty. 100

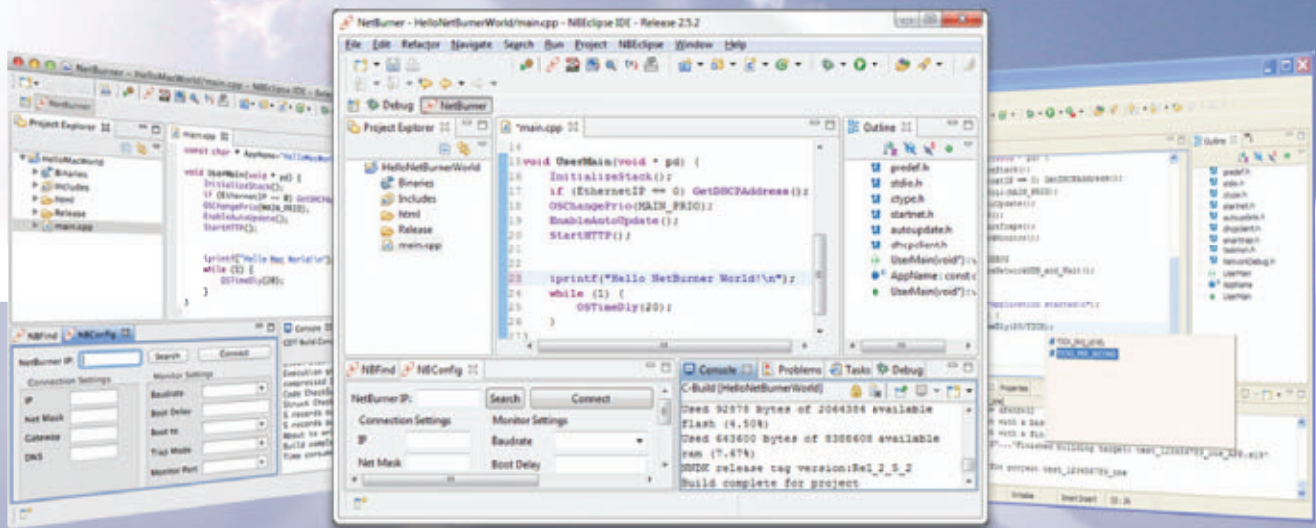

## Quickly create and deploy applications from your Mac or Windows PC

**Low cost NetBurner development kits** are available to customize any aspect of operation including web pages, data filtering, or custom network applications. The kit includes platform hardware, ANSI C/C++ compiler, TCP/IP stack, web server, e-mail protocols, RTOS, flash file system, Eclipse IDE, debugger, and cables. The kit enables you to communicate with peripherals that use SD/MMC Flash Card (including SDHC), SPI, I<sup>2</sup>C, or the general purpose digital I/O interface. The NetBurner security suite option includes SSH v1, v2 and SSL support.

**Development Kit** for MOD54415  
Part No. NNDK-MOD54415-KIT  
\$99.00 for a limited time

**Development Kit** for NANO54415  
Part No. NNDK-NANO54415-KIT  
\$99.00



Information and Sales | sales@netburner.com  
Web | www.netburner.com  
Telephone | 1-800-695-6828





# one SOCKET

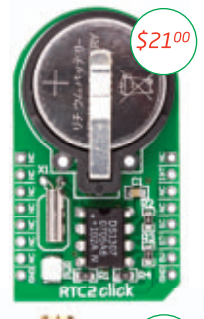
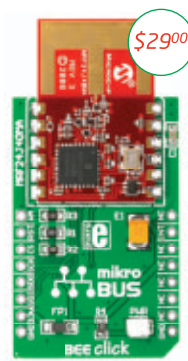
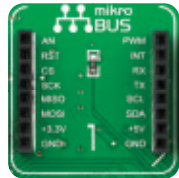

# for ALL boards

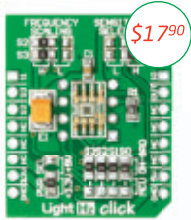
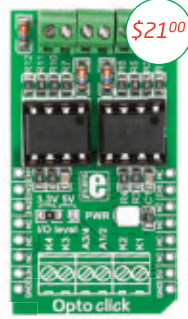

Just place the **Click™** board you need into the innovative new **mikroBUS™** socket and it's ready to work right away.

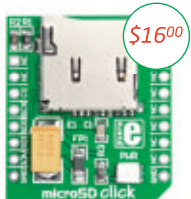
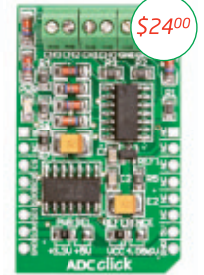
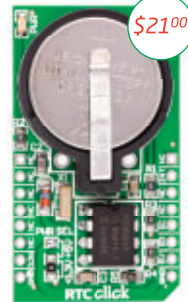
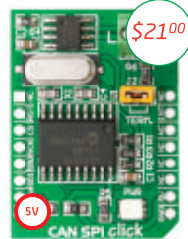
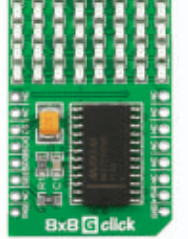
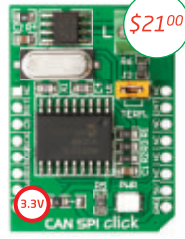
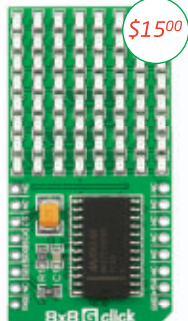
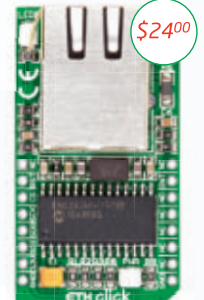
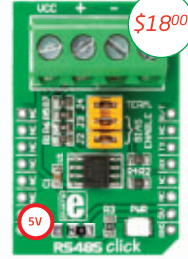
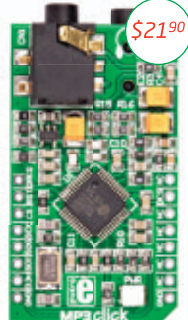
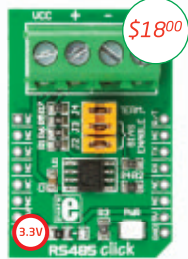
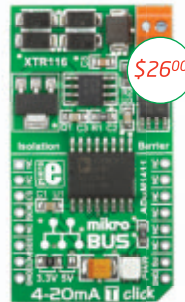
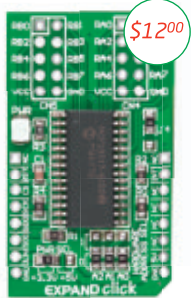
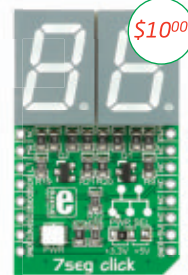
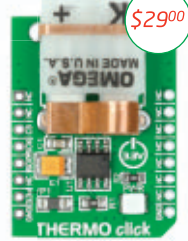

[www.libstock.com](http://www.libstock.com)

**GET IT NOW**  
[www.mikroe.com](http://www.mikroe.com)

NOTE: Two 2x8 male headers are included in the package with each click board.

# Get a little pushy.

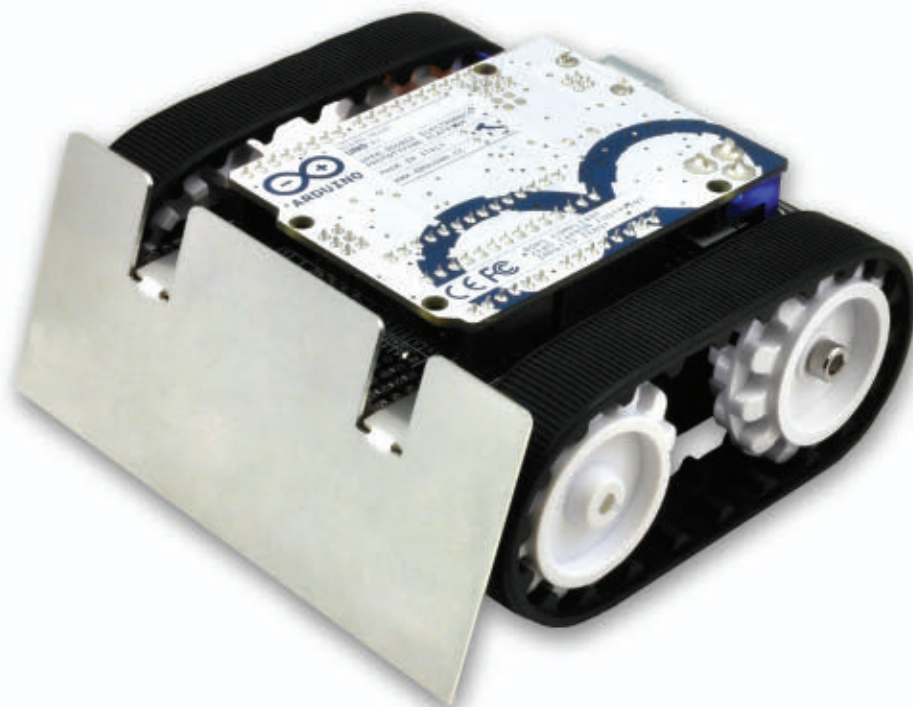

## Zumo

Small enough for Mini-Sumo;  
flexible enough to make it your own.

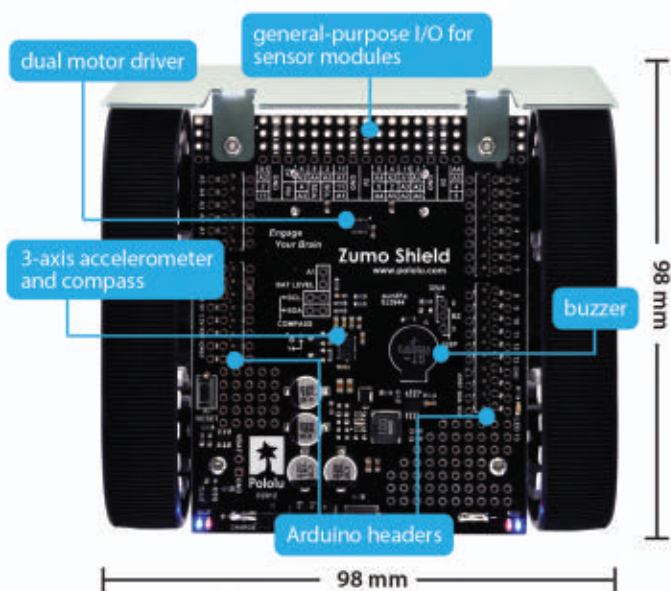

Put your Arduino on the right tracks with the new Zumo chassis and Arduino shield! The Zumo is a small, tracked robot platform that works with a variety of micro metal gearmotors to allow for a customizable combination of torque and speed. Add a Zumo shield, which includes a dual motor driver, buzzer, and three-axis accelerometer and compass, to make an Arduino-controlled robot that can really throw its weight around!

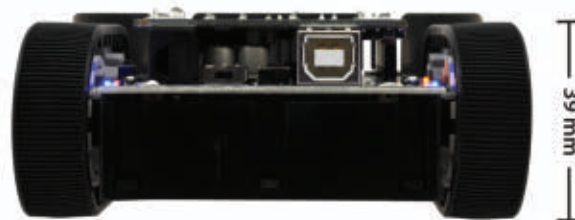

Motor Controllers • Arduino • Signal Generators • FM Transmitters • Timers • Audio Amplifiers

**200 KHz Function Generator**



**\$49.95**  
ASSEMBLED

UK307

**4-Port USB Relay Controller with 6-Channel Analog/Digital Interface**

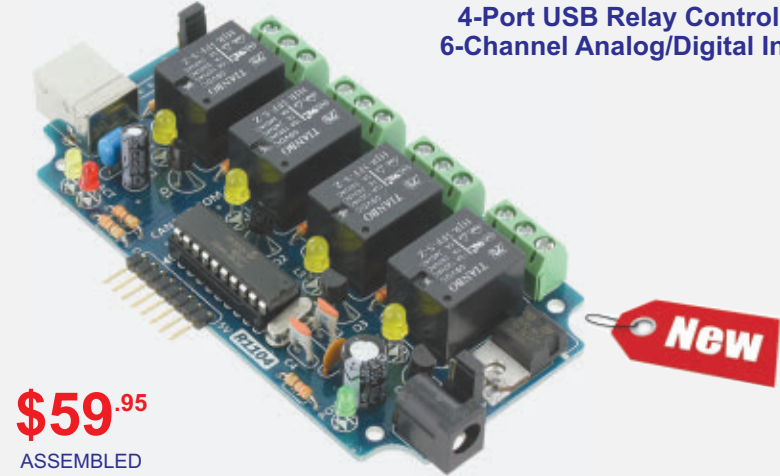

**\$59.95**  
ASSEMBLED

UK1104

**5A Motor Speed Controller (PWM)**



**\$22.95**  
ASSEMBLED

UK1102

**Stereo Audio Amplifier (10W)**



**\$35.95**  
ASSEMBLED

UK560

**Plug-In Breadboard Power Supply**



**\$19.95**  
ASSEMBLED

UK277

**7A Bi-Directional Motor Speed Controller (PWM)**



**\$39.95**  
ASSEMBLED

UK1125

**USB PIC Programmer (MPLAB Compatible)**



**\$69.95**  
ASSEMBLED

UK1300

**Digital LED Timer (Up/Down)**



**\$46.95**  
ASSEMBLED

UK258

\* Limit one per customer. Can not be combined with other coupons or volume discounts. Does not apply to products already on sale. Prices subject to change without notice.

# January 2013

**NEW!**  
NV Mobile App  
now available!  
Details on  
Page 80!



Page 32

## Projects & Features

### 32 The Sirius Metronome for the Serious Musician

One of the most important tools any musician needs is a metronome. The circuit described here sports a number of impressive features that even more expensive commercial units can't provide.

■ By Thomas Henry

### 40 Build an Inverting DC-DC Converter

Ever need negative voltage when all you can get is positive? This voltage mirror device will give you -V out when you put +V in, and works over a range of voltages without adjustment.

■ By Jim Stewart

### 46 King Tut's Pyramid Gravimeter

Use this novel assembly to determine the gravity of most any situation.

■ By Ron Newton

## Columns

### 10 TechKnowledgey 2013 *Events, Advances, and News*

Some of this month's tidbits include a supercomputer that hits 20 petaflops/s, the next-gen of the iMac family, and how to record your entire life effortlessly.

### 14 Smiley's Workshop *Programming • Hardware • Projects* The Arduino Proto Shield Alarm Clock.

### 24 Q & A *Reader Questions Answered Here* Questions about a voltage converter, a trigger LED from a distributor, and a bench top power supply are answered, plus a digital pressure gauge is revisited this time around.

### 52 The Design Cycle *Advanced Techniques for Design Engineers* I'm in an LMX-ISM-242 State of Mind.

### 60 The Spin Zone *Adventures in Propeller Programming* New Life for an Old LCD.

### 72 Near Space *Approaching the Final Frontier* Using the Nearspace Simple Flight Computer.

## Departments

08	DEVELOPING PERSPECTIVES	67	ELECTRO-NET
09	READER FEEDBACK	68	NV WEBSTORE
28	NEW PRODUCTS	71	CLASSIFIEDS
31	SHOWCASE	80	TECH FORUM
		81	AD INDEX

# ALL ELECTRONICS

C O R P O R A T I O N

**QUALITY Parts**  
**FAST Shipping**  
**DISCOUNT Pricing**

CALL, WRITE, FAX or E-MAIL  
for a FREE 96 page catalog.  
Outside the U.S.A. send \$3.00 postage.

## STANDARD RACING SERVO

Analog servo motor. Standard size, 1.55" x 0.73" x 1.46". 49oz-in torque @ 6 Vdc. Speed" 0.23sec/60° @ 4.8V, 0.19 sec/60° @ 6V. 6.5" leads with standard 3-conductor female connector.



**CAT# DCS-110**

5 for \$6.75 each

**\$6.95**  
each

## COMMUNICATION SPEAKER

Extension speaker for Ham, CB, marine or business communications. Improves clarity in noisy environments.



4 ohms. Black case and grill. Adjustable mounting bracket with hardware. 6.5' cord with 3.5 mm mini plug. 2.90" x 2.70" x 1.28" deep, not including bracket.

**CAT# SK-256**

**\$3.50**  
each

## NDIR CARBON DIOXIDE SENSOR

GE, Telaire T6004. Compact Carbon Dioxide sensing module designed to integrate into existing controls and equipment. NDIR (Non-dispersive infrared) gold-plated optics. Diffusion or Flow-through sampling. Module size: 57 x 51 x 19mm.



**CAT# CDS-1**

**\$10.00**  
each

## EL BACKLIGHT, 2.8" X 2.2"

For backlighting displays, control panels, special effects and model lighting. Flexible, produces practically no heat. Operates on 80-120Vac and will run off of inverter or standard "house" electricity. Salmon color in off-state. Glows white when energized. Solderable pins.

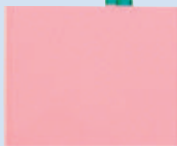

**CAT# EL-15**

100 for \$1.00 each

**\$1.35**  
each

## 33,000UF 50V COMPUTER GRADE CAPACITOR

Nippon Chemi-con U32D 105C. 35mm dia. x 123mm high (excluding terminals). Screw terminals.

**CAT# EC-335**

10 for \$4.50 each

**\$4.75**  
each



## 12 VDC 1.25A SWITCHING POWER SUPPLY

Globtek, Inc. #GTM21089-1512-W2. Input: 100-240V 50-60Hz. Output: 12Vdc, 1.25A 15W. Wall plug-in switching power supply designed for medical use. 72" SPT-1, 18AWG output cord with coax power plug. 5.5 x 2.5 x 11mm, center positive. cULus, VDE.



**CAT# PS-12225**

5 for \$9.35 each

**\$9.95**  
each

## 19 LED HEADLAMP

High intensity, long-lasting LED light with adjustable headstrap for "hands-free" illumination. 3 light levels and flash mode. Adjustable beam angle. Requires 3 AAA batteries (not included). LED lifetime of 100,000 hours.



**CAT# HL-2**

**\$12.95**  
each

## ALPHA-NUMERIC LED DISPLAY

Ledtech # LA3921-11B. 0.4" high character. 14-segment with decimal point. Green LEDs on grey background. Common anode. Fits 18-pin DIP socket. 0.93" x 0.39".



**CAT# SDA-24**

**\$1.25**  
each

## 21MM PIEZO ELEMENT

50mm wire leads.

**CAT# PE-56**

**\$1.00**  
each



10 for 85¢ each

## PROTECTIVE LAPTOP CASES

Great price for a padded case for your 13" or 15" laptop. Designed for MacBook Pro®, will work for other low-profile laptops. Custom fitted inner neoprene sleeve, triple layer ballistic polyester outer cover. Ultra-soft lycra prevents scratching. Adjustable shoulder strap.



13" CASE

**CAT# CSE-013**

**\$7.95**  
each

15" CASE

**CAT# CSE-015**

**\$8.50**  
each

## SOLDERLESS BREADBOARD, 840 CONTACTS

Accommodates all sizes of dips and discrete components. Interconnect with AWG 22 solid hook-up wire. Wires and components can be re-used many times without damage to board or components. Dual row of buss terminals on each side of terminal strip.

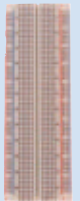

**CAT# PB-840**

**\$7.65**  
each

## 12 VDC XENON FLASHER

Bright strobe assembly with horseshoe flashtube. Approximately 80 flashes per minute. 12 Vdc operation. 65 x 75mm

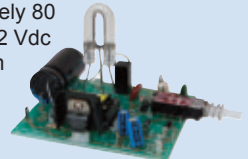

**CAT# FSH-13**

**\$5.50**  
each

## PUSH ON/PUSH OFF

SPST 6A pushbutton. Black plastic body, actuator and panel nut. 3/8-27 threaded bushing. 4 1/2" stranded wire pigtailed. UL listed. Moisture-resistant cap/nut, CAT# WPC-3, 50¢ each.



**CAT# PB-13**

100 for \$1.50 each

**\$1.85**  
each

Shop ON-LINE [www.allelectronics.com](http://www.allelectronics.com)  
ORDER TOLL FREE 1-800-826-5432

MAIL ORDERS TO:  
ALL ELECTRONICS CORP.  
14928 OXNARD ST., VAN NUYS, CA 91411-2610

FAX (818) 781-2653 • INFO (818) 904-0524  
E-MAIL [allcorp@allcorp.com](mailto:allcorp@allcorp.com)



NO MINIMUM ORDER • All Orders Can Be Charged to Visa, MasterCard, American Express or Discover • Checks and Money Orders Accepted by Mail • Orders Delivered in the State of California must include California State Sales Tax • NO C.O.D • Shipping and Handling \$7.00 for the 48 Continental United States - ALL OTHERS including Alaska, Hawaii, P.R. and Canada Must Pay Full Shipping • Quantities Limited • Prices Subject to change without notice.

MANUFACTURERS - We Purchase EXCESS INVENTORIES... Call, Write, E-MAIL or Fax YOUR LIST.



by Bryan Bergeron, Editor

# DEVELOPING PERSPECTIVES

## Cosmic Ray Detector

One of the perks of my position as editor of *Nuts & Volts* is that I get to work with experimentalists, hobbyists, engineers, and scientists who are eager to share their experiments and projects with other readers. While there is the occasional perpetual motion machine or circuit that seems like something repurposed from a 1970's electronics magazine, most are right on. And sometimes there are contributions that are intriguing but don't have the scientific underpinnings to make it into print — it just wouldn't be fair to readers.

For example, I recently had to turn down an article that described how to build a "cosmic ray detector." The author was an exceptional writer and builder, but he couldn't back up his assertion that the device he described actually detected cosmic rays. In fact, he couldn't specify the type of cosmic rays his device was designed to detect.

It apparently detected something, but it could have been static electricity just as well as gamma or beta radiation from the cosmos or from radon gas. Unfortunately, the author didn't have a standard radiation source or radiation detector at his disposal, and so there was no way to verify what — if anything — was being detected.

Although the article didn't make the pages of *Nuts & Volts*, I hope that the author continues his investigation. Many notable inventions and discoveries come about without a solid or even

incorrect scientific backing, and often with no homage paid to the scientific method. Take the Crookes radiometer as an example.

As you may be able to see in the photo of my radiometer, the device consists of four vanes — each of which has one blackened side and one white side. It is encased in a clear glass bulb that has a near perfect vacuum. Crookes believed — incorrectly — that light falling on the device turned the vanes so that the black surfaces were pushed away by the light.

The problem with Crookes' logic is that light falling on the black side should be absorbed, while light falling on the white side should be reflected. Meaning the white side

should be pushed away by the light. It turns out that the radiometer only works in a near vacuum, which supports the current theory that the movement is the result of gasses passing over the edges of the vanes. In a perfect vacuum, the radiometer doesn't operate.

Crookes' radiometer remains a curiosity that's popular with the science crowd, but as a detector it has been supplanted by quantitative, calibrated instruments.

The point is that it's possible for someone to create a device that's operational and yet operates on principles unknown to the inventor. With this in mind, I had waves of second thoughts about the author's cosmic ray detector. However,

lacking any evidence supporting the claim that the signals being detected were — in fact — of cosmic origin, I was forced to place the article in the rejected pile.

By chance, I set the article aside just before the discovery of the long-awaited Higgs Boson. The particle was verified nearly 50 years after its existence was postulated, using multi-million dollar advanced instruments run by teams of scientists.

I suppose I'll never know whether the 'cosmic ray detector' (constructed with perhaps \$50 in parts) could have detected the Higgs Boson.

I hope, however, the experimenter who was temporarily turned away continues with his experiments. Sometimes it takes science a while to catch up with what experimentalists develop by intuition, sweat, and most of all, persistence. **NV**





Published Monthly By  
**T & L Publications, Inc.**

430 Princeland Ct.  
Corona, CA 92879-1300

(951) 371-8497

FAX (951) 371-3052

Webstore orders only **1-800-783-4624**

[www.nutsvolts.com](http://www.nutsvolts.com)

## Subscriptions

Toll Free **1-877-525-2539**

Outside US **1-818-487-4545**

P.O. Box 15277

North Hollywood, CA 91615

## FOUNDER/ASSOCIATE PUBLISHER

Jack Lemieux

## PUBLISHER

Larry Lemieux

[publisher@nutsvolts.com](mailto:publisher@nutsvolts.com)

## ASSOCIATE PUBLISHER/ VP OF SALES/MARKETING

Robin Lemieux

[display@nutsvolts.com](mailto:display@nutsvolts.com)

## EDITOR

Bryan Bergeron

[techedit-nutsvolts@yahoo.com](mailto:techedit-nutsvolts@yahoo.com)

## CONTRIBUTING EDITORS

Jeff Eckert

Russ Kincaid

Joe Pardue

Fred Eady

Thomas Henry

Ron Newton

Jim Stewart

Jon McPhalen

Paul Verhage

## CIRCULATION DEPARTMENT

[subscribe@nutsvolts.com](mailto:subscribe@nutsvolts.com)

## SHOW COORDINATOR

Audrey Lemieux

## MARKETING COORDINATOR WEBSTORE

Brian Kirkpatrick

[sales@nutsvolts.com](mailto:sales@nutsvolts.com)

## WEB CONTENT

Michael Kaudze

[website@nutsvolts.com](mailto:website@nutsvolts.com)

## ADMINISTRATIVE ASSISTANT

Debbie Stauffacher



## PRODUCTION/GRAPHICS

Sean Lemieux

Copyright © 2013 by T & L Publications, Inc.

All Rights Reserved

All advertising is subject to publisher's approval. We are not responsible for mistakes, misprints, or typographical errors. *Nuts & Volts Magazine* assumes no responsibility for the availability or condition of advertised items or for the honesty of the advertiser. The publisher makes no claims for the legality of any item advertised in *Nuts & Volts*. This is the sole responsibility of the advertiser. Advertisers and their agencies agree to indemnify and protect the publisher from any and all claims, action, or expense arising from advertising placed in *Nuts & Volts*. Please send all editorial correspondence, UPS, overnight mail, and artwork to: **430 Princeland Court, Corona, CA 92879**.

Printed in the USA on SFI & FSC stock.  

# READER FEEDBACK

## XBee for ZigBee

In his December issue article "Build Your Own Sensor Network..." Tom Kibalo provides helpful information about using XBee modules. I highly recommend *The Hands-On XBee Lab Manual* by Jon Titus for more details in a step-by-step lab experiment format. People interested in using XBee modules for ZigBee mesh networks should read Robert Faludi's *Building Wireless Sensor Networks*.

Millard Johnson

New York, NY

## Lost in Space

On page 11 of the December 2012 issue there is a mention about the Curiosity (MSL) rover simulator. However, the photo is of a Spirit/Opportunity class rover – not Curiosity. You might want to print a correction.

Mark Lewus

Denville, NJ

*Jeff Eckert's response:* Yep. My mistake. Here's the right one. They do have a strong family resemblance, however.



Here's a recent self-portrait:



As described by NASA ... the *Curiosity* rover used the *Mars Hand Lens Imager (MAHLI)* to capture a set of 55 high-resolution images which were

Continued on page 71

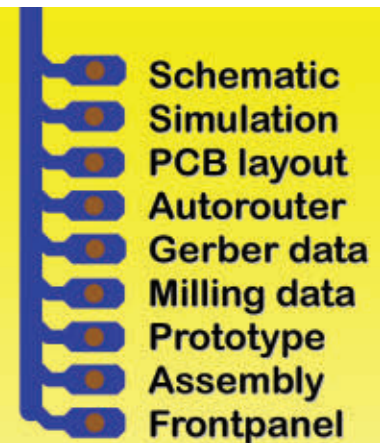

# TARGET 3001!

## PCB Layout CAD Software

Easy to use. All in one.

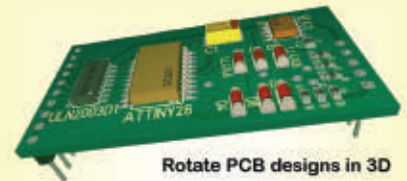

Rotate PCB designs in 3D



## SQL database

Over 35,000 parts  
Search for parts  
by parameter  
Draw custom parts  
Direct part links to  
Newark®-Farnell®  
DigiKey®, etc.



## Assembly

SMT and THT  
Calculate the price  
of your PCB within  
the software and  
get prototypes back  
even fully assembled



## Free version

Fully functional  
250 pins, 2 layers  
No registration  
No codes, no dongle  
No time restriction  
Max. size: 47" x 47"

Call Jim Schaefer

(530) 763 2299

[jim@target-3001.com](mailto:jim@target-3001.com)



[www.target-3001.com](http://www.target-3001.com)

## ADVANCED TECHNOLOGY

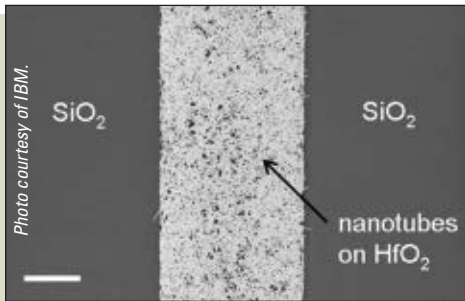

Photo courtesy of IBM.

### WATCHING THE TUBES

For a couple decades, universities and research labs have been touting the wonders of carbon nanotubes, but it has seemed like — somehow — nothing

practical ever emerges from the technology. Indeed, "Carbon nanotubes ... have largely been laboratory curiosities as far as microelectronic applications are concerned," noted a researcher at IBM Labs ([www.research.ibm.com](http://www.research.ibm.com)). However, IBM recently announced a breakthrough that defines a serviceable manufacturing process for carbon semiconductors that are cheaper and faster than silicon-based devices.

A carbon nanotube is just a one-atom-thick sheet of carbon that has been rolled up to form a tube. The tube can be used to form the core of a transistor, with the advantage that it takes up less than 10 nm of space (half the size of the most advanced silicon devices) and yet offers between five and ten times better performance. They come with two basic problems, though. First, when you generate the things (via arc discharge, laser ablation, or other methods), they come in a mix of metallic and semiconducting versions. You have to somehow separate the two, as only the semiconducting ones are useful for electronic devices. Second, you have to precisely control the alignment and placement of them on a device substrate, which is not exactly something you can do with a magnifying glass and a pair of tweezers. It has been reported in various journals that the two types can be separated fairly easily by various chemical processes, so that doesn't seem to be the fly in the ointment. To overcome the second hurdle, IBM has developed a "novel method based on ion-exchange chemistry that allows precise and controlled placement of aligned carbon nanotubes on a substrate at a high density."

The bottom line is that researchers have succeeded in depositing more than 10,000 of them on a single chip using readily-available mainstream manufacturing processes. We're still not looking at commercial devices in the immediate future, but, "As this new placement technique can be readily implemented involving common chemicals and existing semiconductor fabrication, it will allow the industry to work with carbon nanotubes at a greater scale and deliver further innovation for carbon electronics." ▲

## SUPERCOMPUTER HITS 20 PETAFLOPS/S

The position of top dog in the battle for supercomputer supremacy is constantly shifting. In November 2010, it belonged to China's Tianhe-1A system, with a demonstrated performance of 2.57 petaflops per second (as rated by [www.top500.org](http://www.top500.org)). By June 2011, it had shifted to Japan's K Computer (8 petaflops/s), which retained the title the following November after pushing its performance to 10.51 petaflops/s.

However, the USA regained its traditional dominance in June 2012 thanks to the IBM BlueGene/Q system (16.32 petaflops/s) installed at the Lawrence Livermore Lab. By the time you read this, the Oak Ridge National Lab should have picked up the torch with Titan — the first machine to achieve 20 petaflop/s.

In case you have forgotten, a petaflop is a quadrillion floating-point operations, so we're talking about 20,000 trillion calculations per second. To try to put that into perspective, imagine that there is no such thing as hair loss. Then, take the number of hairs on the heads of all seven billion people on Earth and multiply it 23 times. That's pretty close to the number we're talking about.

For those who are interested in Titan's guts, note that it is a Cray XK7 system that contains 18,688 nodes — each of which operates with a 16-core AMD Opteron 6274 processor and an NVIDIA Tesla K20 GPU accelerator. These have access to 7,000 TB of memory. Titan will be harnessed to provide computing power for research in energy, climate change, efficient engines, materials, and other disciplines. Even though Titan is at the top of the heap now, competitors will be nipping at its heels as time goes by. In fact, in early October 2012, China announced that it is building a machine that — when deployed in 2015 — will run at 100 petaflops/s. ▲

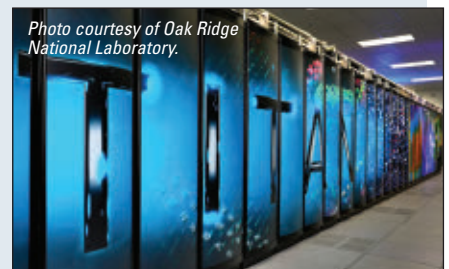

Photo courtesy of Oak Ridge National Laboratory.

■ The Titan supercomputer hits 20 petaflops/s performance.

Discuss this article in the Nuts & Volts forums at <http://forum.nutsvolts.com>.

## COMPUTERS AND NETWORKING

### NEXT-GEN iMAC FAMILY

As of the most recent data from DisplaySearch ([www.displaysearch.com](http://www.displaysearch.com)), the Apple iMac remains the leader in the all-in-one market, with a 32.9 percent share as compared to machines from Lenovo (22.7 percent) and HP (21.4 percent). Aimed at maintaining that lead is the latest lineup, billed as "the most advanced desktop Apple has ever made." According to Apple, the new aluminum and glass enclosure takes up 40 percent less volume than the previous models, with 5 mm perimeters that are almost literally cutting edge. The reengineered display reduces reflection by 75 percent via a laminated cover glass and a plasma-deposited anti-reflective coating, and each unit is individually color calibrated using a spectroradiometer to ensure optimal color and contrast.

The guts include third-generation quad-core Intel Core i5 processors with an upgrade to Core i7 available, and NVIDIA GeForce processors for 60 percent faster gaming and graphics processing. Both the 21.5 and 27 inch models come standard with 8 GB of 1,600 MHz RAM and a 1 TB drive, but you can upgrade to as much as 32 GB of memory, 3 TB of disk storage, or a 768 GB Flash. Also standard are two Thunderbolt and four USB

■ Thinner iMacs offer 21.5 and 27 inch displays.



3.0 ports. Those interested in "green" considerations will appreciate that they meet Energy Star 5.2 requirements and use 50 percent less idle energy than their ancestors. Plus, the LED-backlit displays are mercury free and made with arsenic free glass. Prices haven't changed much, with the smaller model running \$1,299 base or \$1,499 loaded, and the larger one at \$1,799 or \$1,999. ▲

### MICROSOFT REFOCUSSES ON DEVICES AND SERVICES

Other than the Xbox, Microsoft hasn't made much of a dent in the hardware world. (Remember the Kin family of mobile phones? Well, neither does anyone else.) But that hasn't stopped the company from pushing ahead. In fact, CEO Steve Ballmer recently advised shareholders that the company has officially shifted its focus "both in what we do and how we see ourselves — as a devices and services company" rather than just a software vendor. Hence, the Surface line of tablets announced last June 2012 and hitting the stores in October that same year.

Two versions are available: one packaged with Windows 8 Pro (with Intel CPU) and the other with Windows RT (ARM powered). Both feature the VaporMg molded magnesium case, allowing the units to weigh in at only 1.5 lb (680 g), and include an integrated kickstand, a 10.6 x 16.9 inch display, and a choice of optional keyboard covers. The "touch cover" allows users to touch type on a flat surface, whereas the "type cover" adds moving keys for those who prefer a traditional typing feel.

Worth noting is that you can't install any of your existing Windows 7 applications on the RT model, as they won't run on an ARM processor. You are therefore — at least for now — limited to whatever you can buy at the Windows store. The RT version will run you between \$499

■ Microsoft's Surface tablet, available in both Intel and ARM versions.



and \$699. Prices for the 8 Pro models were not available as of this writing, but you can likely find them and other details at [www.surface.com](http://www.surface.com).

It's not yet clear how well the Surface will do against competitors, but one survey of 7,500 consumers indicated that about a third would buy one if priced in the same ballpark as an iPad. A Morgan Stanley analyst has predicted that Microsoft will sell about nine million units this year, giving it a market share of about 14 percent. ▲

# CIRCUITS AND DEVICES

## BIG IMAGE, SMALL PROJECTOR

Long ago in the dark ages of large image projection, you had to spend a couple thousand dollars or more for a machine that took two people to lift, produced dim fuzzy images, and generated more heat than a Cummins diesel. Things have changed radically these days, as evidenced by the 3M Streaming Projector from — appropriately enough — 3M ([www.3m.com](http://www.3m.com)). The company has teamed with Roku ([www.roku.com](http://www.roku.com)) to provide "a truly unique and affordable entertainment experience by bringing back big screen viewing." Even though it is small enough to hold in one hand, the device allows you to project an image of up to 120 inches on almost any flat surface: a wall, ceiling, or even the side of your house.

The projector is equipped with Roku's Streaming Stick which gives it access to 600+ channels from Netflix, Hulu Plus, Amazon Instant Video, and a range of free channels. The device is said to operate for up to 2.5 hr on a battery charge, making it useful for things like "family movie nights, sleepovers, and evening backyard parties." Or, you can run it continuously on AC power. It even has a stereo audio output, so you can plug it into a good sound system.

On the negative side, this isn't exactly HD as the maximum resolution is 800 x 480, and the underwhelming 60 lumens output (a 23W CFL emits about 1,500 lm) means that it works best in total darkness. Obviously, you won't be using the thing for a stockholder's meeting in a big auditorium which makes the \$299.99 price tag a little iffy, but you can also project material from a TV equipped with an MHL port or even your computer. So, you can set it up outside and horrify your neighbors with those "art movies" you shot back in college. You have to consider the fun factor. ▲

■ The Streaming Projector from 3M and Roku.



■ The Autographer camera from OMG Life.

## RECORD YOUR ENTIRE LIFE EFFORTLESSLY

If you are a career politician, televangelist, motivational guru, or other form of pathological narcissist, you're going to love Autographer — the first consumer product from the UK's OMG Life ([www.omgplc.com/companies/life](http://www.omgplc.com/companies/life)). If not, meh. Autographer is a wearable digital camera that dangles from a neckstrap and takes a continuous stream of photos that document the marvelousness that is your life. It can capture literally thousands of pictures per day, allowing you to "live the experience while Autographer spontaneously captures the stories that unfold."

This is accomplished using an extreme wide-angle (136°) lens, so you don't even have to aim it. The kicker, however, is that you don't even need to decide when it is appropriate to grab a snapshot. Rather, it uses five internal sensors and a GPS to make that decision based on "subtle changes in light, color, motion, direction, and temperature."

Then, when the day is done, you can use stop-frame video to relive all of your activities in just a few minutes. Autographer is initially available in the UK at a list price of £399 (\$639 as of this writing), where the manufacturer believes that it will serve a market of up to 4.5 million buyers (about seven percent of the population). Uh, huh. ▲

# INDUSTRY AND THE PROFESSION

## NO RISK FOUND

For many years, there has been speculation about the possible hazards of cell phones and other transmitting devices, but the word from a Norwegian expert committee appointed by the Norwegian Institute of Public Health is that you can put your fears to rest. The committee has assessed the health hazards from low-level electromagnetic fields generated by radio transmitters such as mobile phones, wireless phones and networks, mobile phone base stations, broadcasting transmitters, and other communications equipment. After evaluating the power of such fields, whether they pose a health risk,

current regulatory practices, and whether the threshold limit values for exposure are observed, they released a report entitled, "Low-level Radiofrequency Electromagnetic Fields — an Assessment of Health Risks and Evaluation of Regulatory Practice." The group found no evidence that the low-level fields around mobile phones and other transmitters increase the risk of cancer, impair male fertility, cause other reproductive damage, or lead to other diseases and adverse health effects, such as changes to the endocrine and immune systems. So keep on talking, folks. If you want a PDF of the 200 page report, just log onto [www.fhi.no](http://www.fhi.no). **NV**

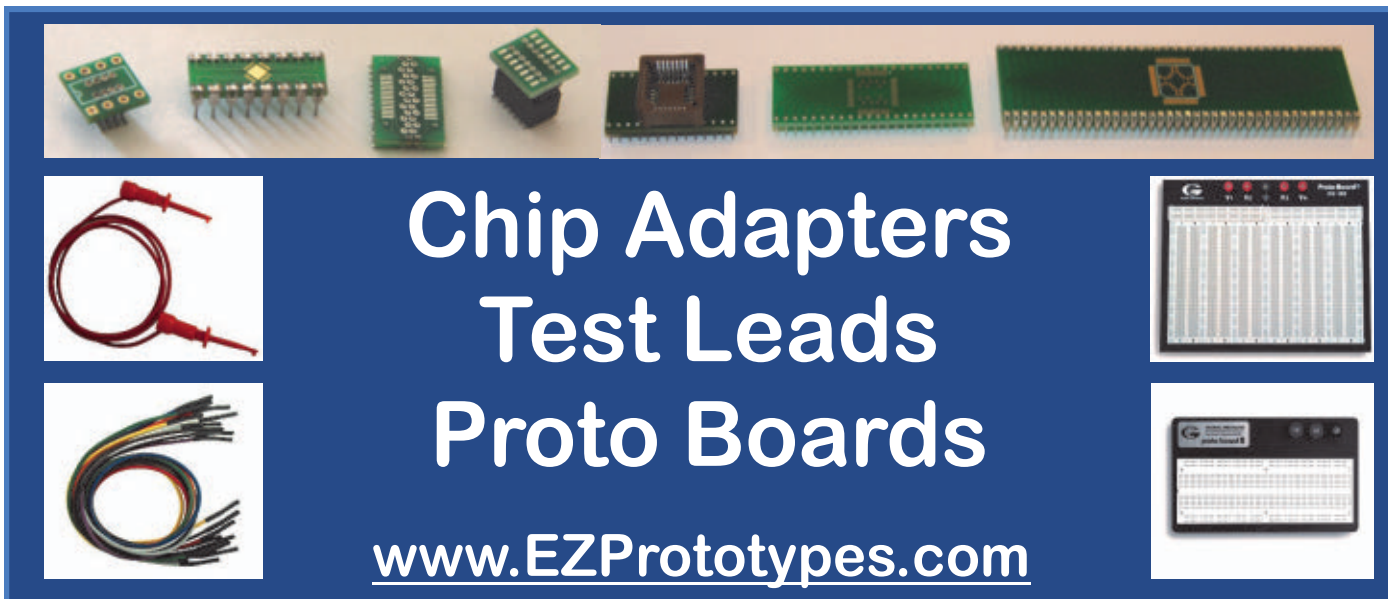

**Chip Adapters  
Test Leads  
Proto Boards**

[www.EZPrototypes.com](http://www.EZPrototypes.com)



Visit our website at <http://www.elexp.com>

<p><b>RSR</b>— 3MHZ SWEEP FUNCTION GENERATORS 6 Waveform Functions, Int/Ext Counter, lin/log sweep <b>MODEL FG-30</b> (No Digital Display) \$135<sup>00</sup> <b>MODEL FG-32</b> (5 Digit Display) \$195<sup>00</sup></p>	<p><b>GW INSTEK</b> <b>OSCILLOSCOPE</b> <b>MODEL GDS1042</b> Dual Channel 40MHZ DSO</p>	<p><b>DC POWER SUPPLIES</b> <b>MODEL HY3003</b> - DIGITAL DISPLAY Variable output, 0-30 VDC, 0-3 Amp \$95<sup>00</sup> <b>MODEL HY3003-3</b> - TRIPLE OUTPUT Two 0-30 VDC, 0-3 Amp variable outputs plus 5V 3A fixed. Digital Display. \$184<sup>00</sup></p>	<p><b>Weller</b>® SOLDERING STATION #1 BEST SELLING \$46<sup>50</sup> <b>STATION</b> <b>MODEL WLC 100</b> 0603WLC100</p>																												
<p><b>BENCH DMM WITH RS232 INTERFACE</b> <b>MODEL DM9803R</b> True RMS, digital and bar graph display, AC/DC Cap, Res, frequency functions. Includes software, AC or DC operation. \$139<sup>95</sup></p>	<p><b>DIGITAL MULTIMETER</b> <b>32 Ranges - 3 1/2 Digit</b> <b>MODEL MY-64</b> \$33<sup>95</sup> AC/DC Volt/Current, Res. Cap., Frequency. Rubber Holster Included</p>	<p><b>ALLIGATOR LEADS</b> SET OF 10 \$3<sup>50</sup></p>	<p><b>RSR</b>— HIGH PERFORMANCE 3-WIRE IRON #060509 \$7<sup>50</sup></p>																												
<p><b>SWITCHES</b></p> <table style="width: 100%; border-collapse: collapse;"> <tr> <td></td> <td style="text-align: center;">1-9</td> <td style="text-align: center;">10+</td> </tr> <tr> <td>8 POS DIP (V17DIP8SS)</td> <td style="text-align: center;">.90</td> <td style="text-align: center;">.85</td> </tr> <tr> <td>Toggle Mini SPDT (17TOGSD-M)</td> <td style="text-align: center;">1.40</td> <td style="text-align: center;">1.20</td> </tr> <tr> <td>Toggle Mini DPDT (17TOGDD-M)</td> <td style="text-align: center;">\$1.55</td> <td style="text-align: center;">1.35</td> </tr> </table>		1-9	10+	8 POS DIP (V17DIP8SS)	.90	.85	Toggle Mini SPDT (17TOGSD-M)	1.40	1.20	Toggle Mini DPDT (17TOGDD-M)	\$1.55	1.35	<p><b>POTENTIOMETERS</b></p> <table style="width: 100%; border-collapse: collapse;"> <tr> <td></td> <td style="text-align: center;">1-9</td> <td style="text-align: center;">10-99</td> <td style="text-align: center;">100+</td> </tr> <tr> <td>Cermet (STS Series)</td> <td style="text-align: center;">85¢</td> <td style="text-align: center;">75¢</td> <td style="text-align: center;">65¢</td> </tr> <tr> <td>Multiturn (MTT Series)</td> <td style="text-align: center;">70¢</td> <td style="text-align: center;">60¢</td> <td style="text-align: center;">45¢</td> </tr> <tr> <td>Panel Mount (PMA Series)</td> <td style="text-align: center;">\$1.15</td> <td style="text-align: center;">80¢</td> <td style="text-align: center;">70¢</td> </tr> </table> <p style="text-align: center; font-size: small;">Standard Values Available</p>		1-9	10-99	100+	Cermet (STS Series)	85¢	75¢	65¢	Multiturn (MTT Series)	70¢	60¢	45¢	Panel Mount (PMA Series)	\$1.15	80¢	70¢	<p><b>SOUND SENSOR CAR</b> <b>REQUIRES SOLDERING</b> Reverses direction whenever it detects noise, or touches an obstacle. \$9<sup>95</sup> #3221881</p>	<p><b>RSR</b>— DIGITAL SUPER ECONOMY MULTIMETER \$6<sup>50</sup> <b>MODEL 820B</b> 1-9 . . . . \$7.50 #01DM820B</p>
	1-9	10+																													
8 POS DIP (V17DIP8SS)	.90	.85																													
Toggle Mini SPDT (17TOGSD-M)	1.40	1.20																													
Toggle Mini DPDT (17TOGDD-M)	\$1.55	1.35																													
	1-9	10-99	100+																												
Cermet (STS Series)	85¢	75¢	65¢																												
Multiturn (MTT Series)	70¢	60¢	45¢																												
Panel Mount (PMA Series)	\$1.15	80¢	70¢																												

**TERMS: Min. \$20 + shipping. School Purchase Orders, VISA/ MC, Money Order, Prepaid. NO PERSONAL CHECKS, NO COD. NJ Residents: Add 7% Sales Tax.**

In NJ: 732-381-8020  
FAX: 732-381-1006

**900 Hart Street • Rahway, NJ 07065**  
**800-972-2225**

<http://www.elexp.com>  
email: [electron@elexp.com](mailto:electron@elexp.com)



# SMILEY'S

# #54 WORKSHOP

C PROGRAMMING - HARDWARE - PROJECTS

## Part 6

# ARDUINO PROTO SHIELD ALARM CLOCK

Last month, we finished our Fritzing workshops by tying up a few loose ends and then introduced some practical applications with a couple of very useful new hardware project kits that will let us easily implement Fritzing designs. We looked at an Arduino proto shield and a breadboard battery that we used with Fritzing to design an Arduino based alarm clock on a mini breadboard. This month, we will transfer the components from the mini breadboard to the underlying Arduino PCB prototyping area on the proto shield as shown in Figure 1. This will provide a robust prototype that we will then use to write some alarm clock software that is not only useful in itself, but provides a good basis for more advanced data logging projects. You can get the Arduino proto shield, the breadboard battery, and the alarm clock kit from the *Nuts & Volts* webstore. But first, we have some great news from Fritzing! They are fixing that bad ol' parts editor, so let's see what they did, then move on to the proto shield based alarm clock.

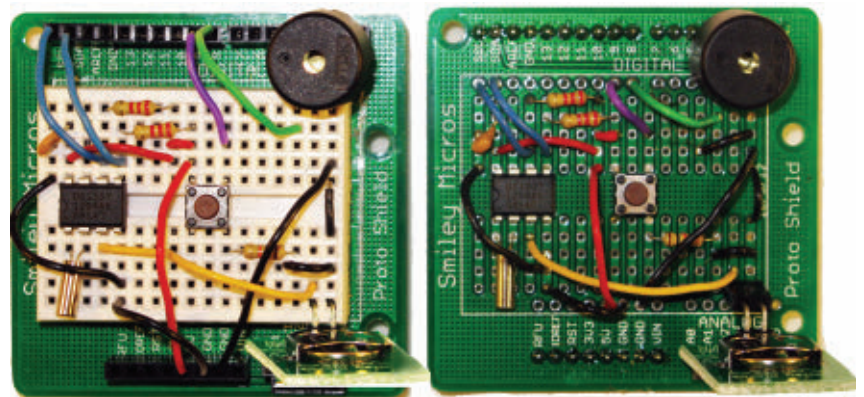

■ FIGURE 1. Proto shield alarm clock on breadboard and PCB.

## FRITZING NEW PARTS EDITOR!

The folks at Fritzing just released a new version for their parts editor. If you remember from earlier articles, the old parts editor starts with a warning that it really isn't ready for serious use being a beta and all, but I used it anyway and provided a bunch of examples in earlier articles. Now that stuff is no longer exactly valid. Swell!

You can get some information on this new thing at <http://fritzing.org/news/new-parts-editor-released>. Who knows, by the time you read this that link may still be valid, but I'd suggest looking around a bit since no telling what may happen between the time my finger hits the keys and the ink dries on the paper.

So, to help keep us up-to-date, I'll discuss how to create a simple part with the new parts editor. First, you'll need to download the newest Fritzing (as of this writing, that's 0.7).

We are going to recreate the breadboard battery part that we discussed in an earlier article. I chose this since I already had the artwork and it only involves two pins. [Also, I upgraded to Win8 and lost the part in the process — oh well.] To create a

part, you start by selecting a pre-existing part such as the generic IC or — as we'll do here — the Mystery Part as shown in **Figure 2**.

The next step is to set the pin number to 2 as shown in **Figure 3**.

Then, right-click on the Mystery

Part and click on the "Edit (new parts editor)" as shown in **Figure 4**.

This will open a new window as shown in **Figure 5**.

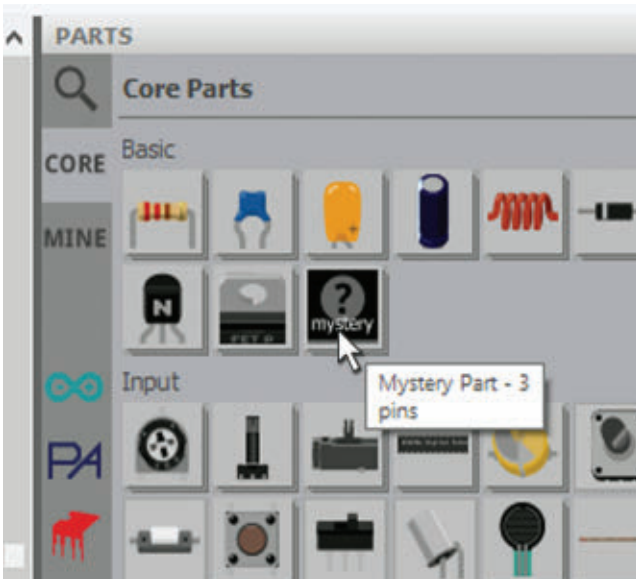

■ FIGURE 2. Use the Mystery part.

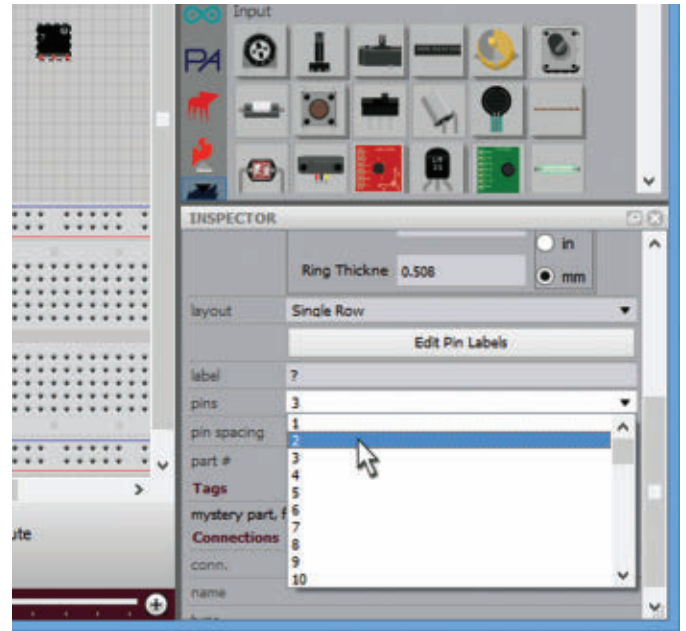

■ FIGURE 3. Set it to two pins.

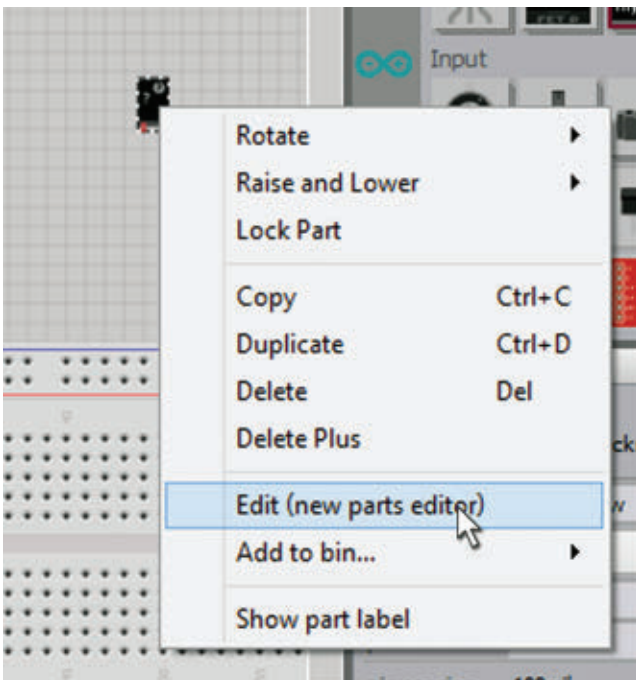

■ FIGURE 4. Open the new parts editor.

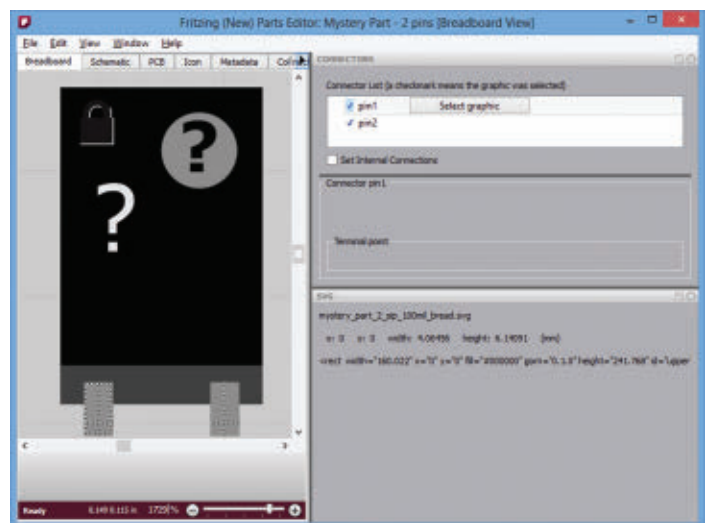

■ FIGURE 5. The new parts editor.

With the Breadboard tab selected, click on 'File\Load image for view...' as shown in **Figure 6**.

Now, browse to the svg (scaled vector graphics) file that you are going to use. We discussed a little about creating svg files in Inkscape in an earlier article. Unfortunately, you have to modify the svg file, but fortunately the modification is simple.

Open the svg file in a good text editor like Programmer's Notepad, and have it search and delete all occurrences of "px." This is necessary to get the text to show in Fritzing. (Thank you Jonathan Cohen for telling me how to fix this on the Fritzing forum; he says they'll fix it in Fritzing.) Once you make the deletion, you can load the file in **Figure 7**.

The schematic drawing is shown in **Figure 8**. I had to

create this drawing from scratch, keeping in mind that the schematic drawings are much bigger than the breadboard drawings. I'm not sure why, but the breadboard drawings have pin spaces as they are in the real world. Thus, the GNE and VBAT pins are 0.1" apart, but in the schematics most of the pins are 0.3" apart (meaning that I had to make the schematic image three times larger than the breadboard image).

For the PCB drawing, we will just keep the default image that we inherited from the Mystery Part as shown in **Figure 9**.

Just keep in mind when you are laying out a PCB that you'll need to allow a full 0.5" width to accommodate the part.

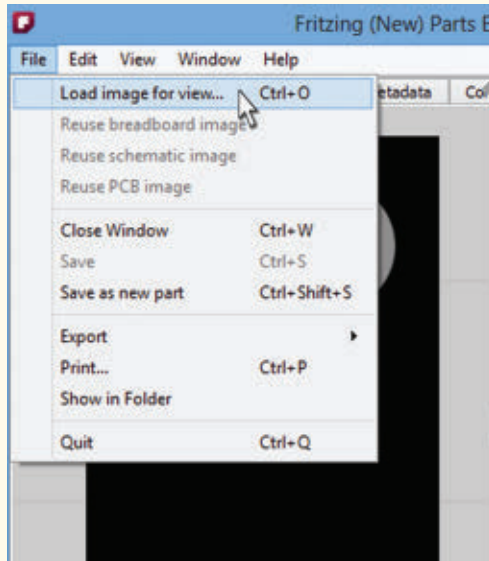

■ FIGURE 6. Load the breadboard image.

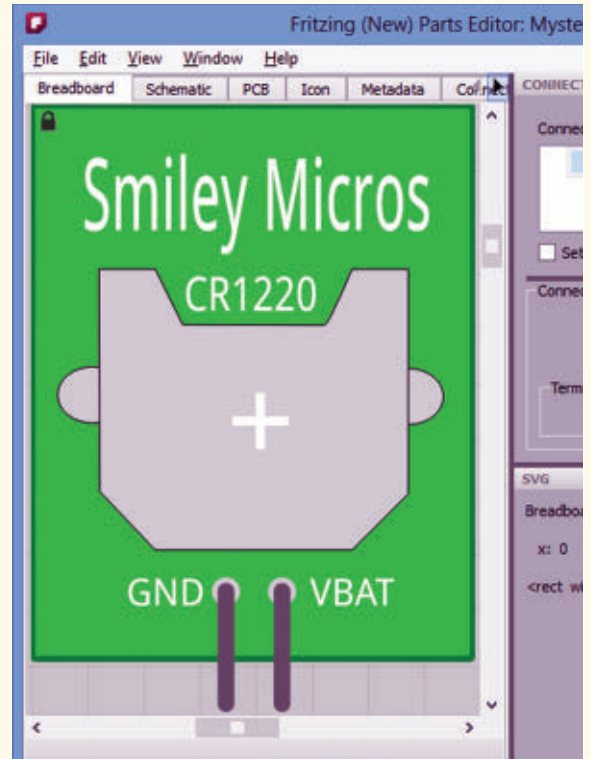

■ FIGURE 7. The breadboard image.

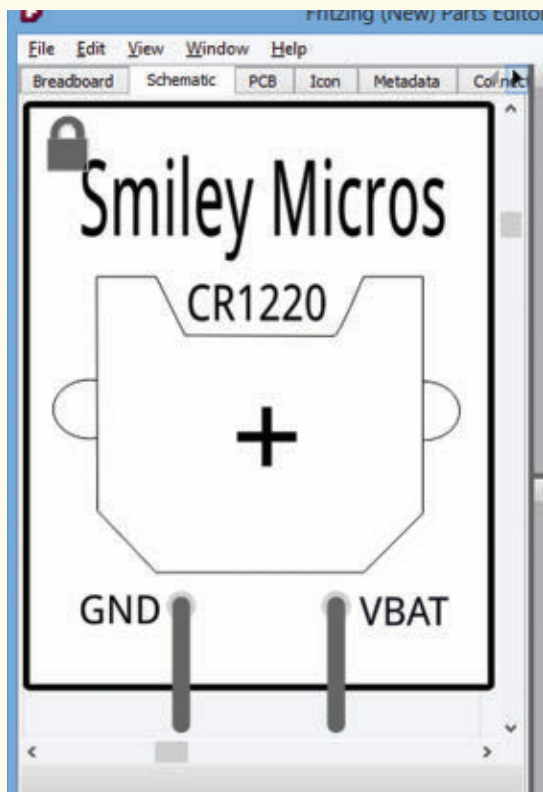

■ FIGURE 8. The schematic image.

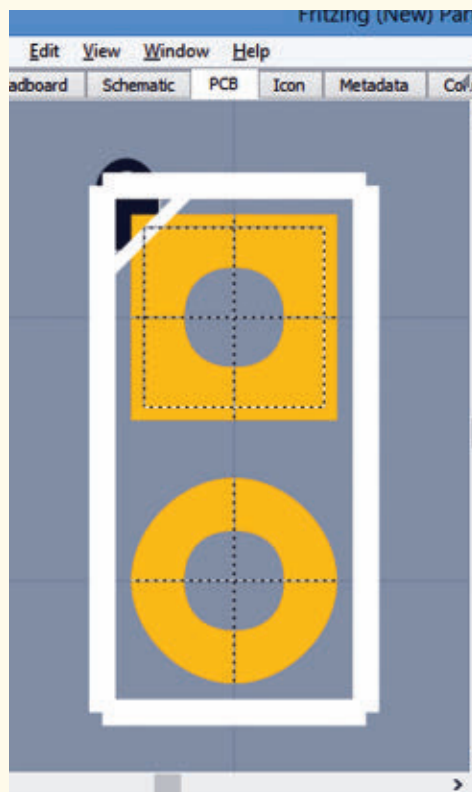

■ FIGURE 9. The PCB image.



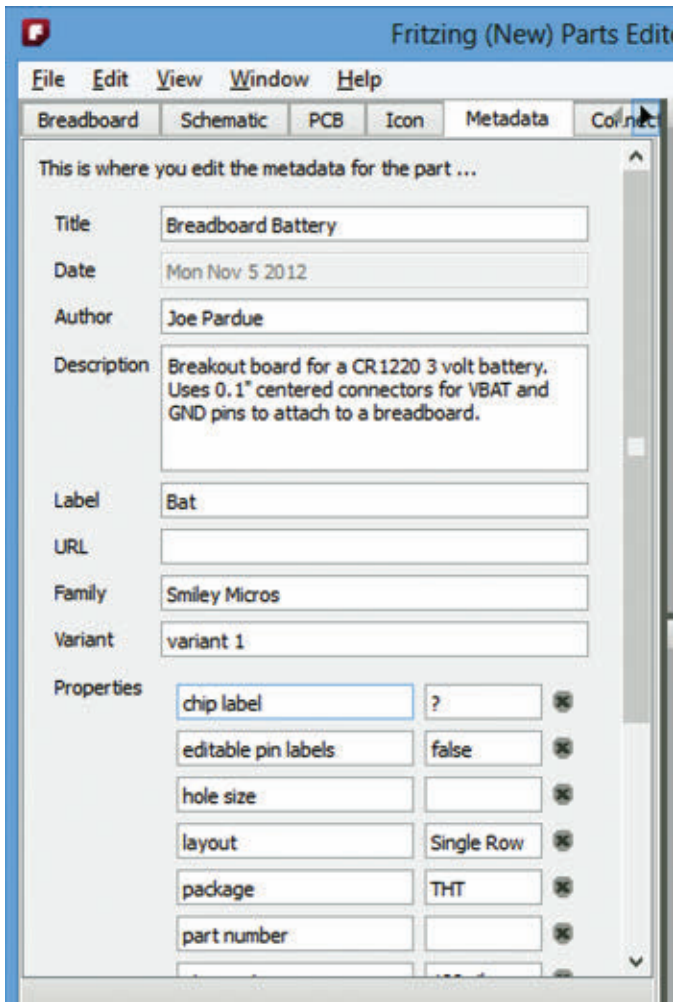

■ FIGURE 10. Metadata.

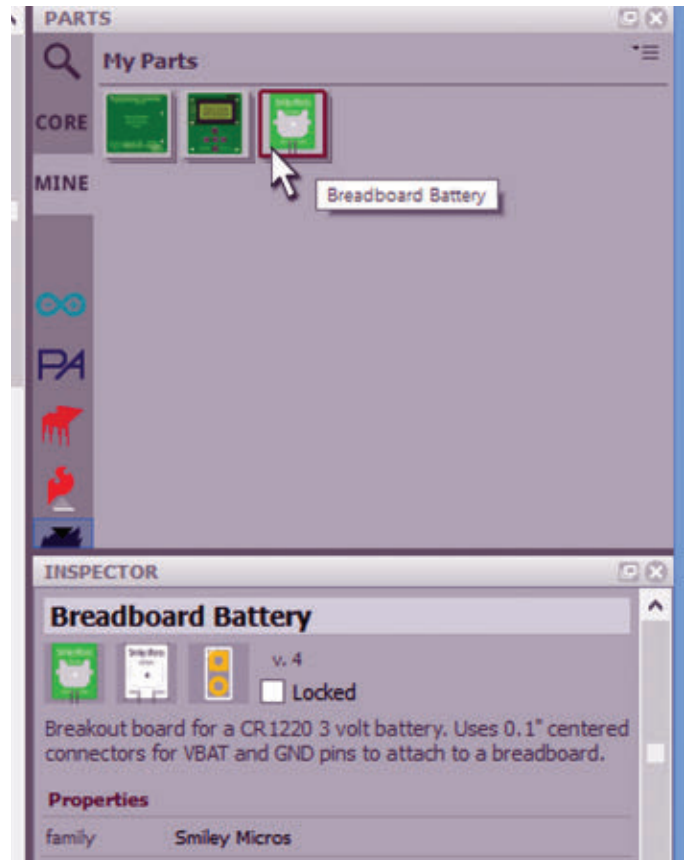

■ FIGURE 11. Metadata in Inspector.

■ FIGURE 12. Pin 1 Select graphic.

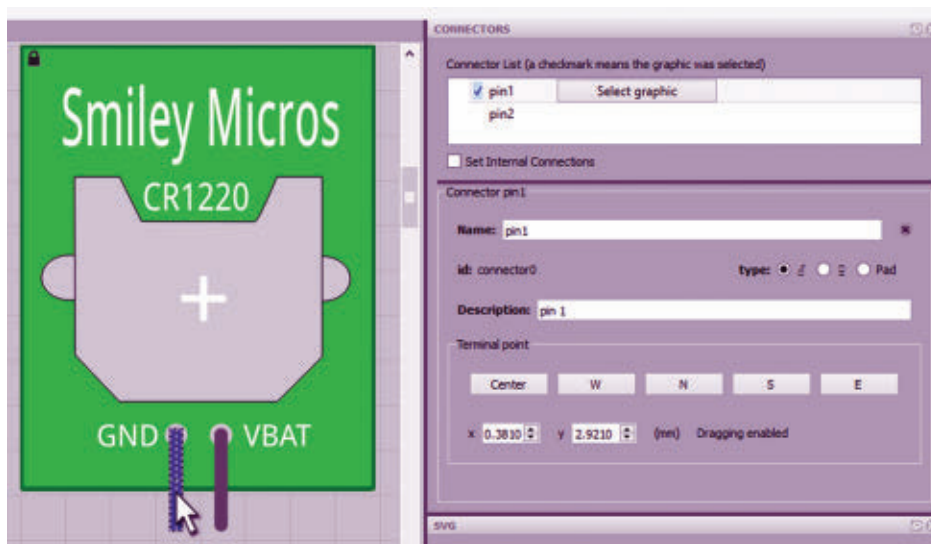

Next, we open the Metadata tab and fill in some relevant information as shown in **Figure 10**. When you save the part, it will be in your Mine bin. If you highlight it, you can see the metadata shown in **Figure 11**.

Now, we go back to the breadboard image and assign the pins. Click on the 'Select graphic' item for the pin and then click on the indicated pin (**Figure 12**).

Now, click on the pin and you'll see dotted lines forming a box with a cross in the middle. Grab the cross point and move it to

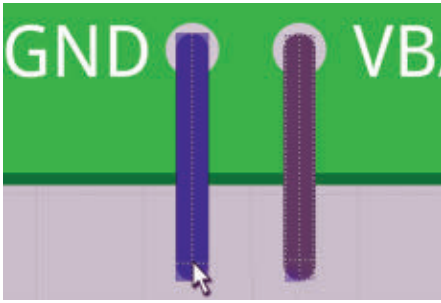

■ FIGURE 13. Move the anchor point center.

near the end of the pin as shown in **Figure 13**. This action sets the anchor point for wires drawn between pins.

Repeat the process for the schematic image and then save the part. It will show up in your Mine bin as we saw before in **Figure 11**. Then what? Is that all? Yup! This is a lot easier to use than the old parts editor and it didn't flake out even once. Of course, I messed up (only once with the "px" thing), but I got an almost

instant response back to my query on the Fritzing forum.

So, yes I'm happy with this. Not only for what it does, but also for what it bodes for the future of Fritzing. I would like to give one more big shout-out to Jonathan Cohen of **Fritzing.org** for all he has done. This was the Phase 1 release; I can't wait till the Phase 2 version comes out!

## MOVING THE PARTS FROM THE BREADBOARD TO THE PCB

Let's take a look at the proto shield PCB in **Figure 14**.

We can see the Arduino pins around the periphery of the PCB, but also notice that there is a matching

set of pins just inside the white box border. These pins are attached to the Arduino pins which are highlighted in yellow in **Figure 15**.

We have two basic ways to use the proto shield: with the mini breadboard or without the mini breadboard. Notice in the center area of the PCB you see a bunch of columns of pins that are highlighted in **Figure 16**.

These columns exactly match the connections in the mini breadboard.

## ATTACHING THE HEADERS

There are two ways to use the headers on the proto shield, depending on which kit you get. In one, the headers are intended to pass

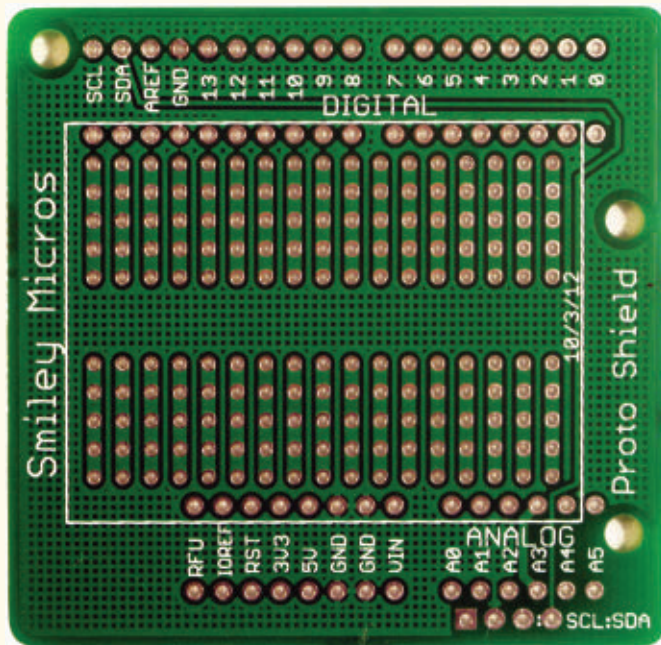

■ FIGURE 14. Proto shield PCB.

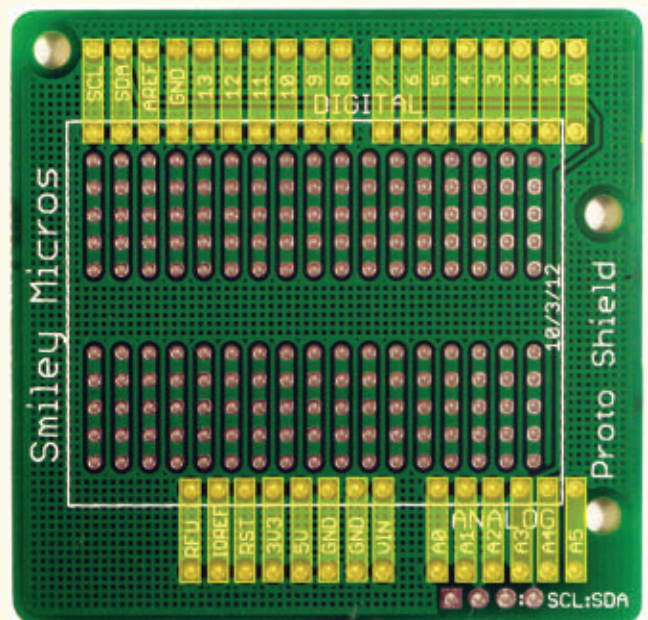

■ FIGURE 15. Proto shield PCB with pins highlighted.

the Arduino signals through the PCB and make them available via female sockets to additional shields that can stack on top of the pass-through header. In the other, regular male headers are used to attach the proto shield to an Arduino, but do not have female extensions. Therefore, they will not allow the use of additional shields above the proto shield. The pass-through male/female headers are more delicate and expensive than the cheaper and more robust male headers.

■ FIGURE 16. Breadboard with matching columns highlighted.

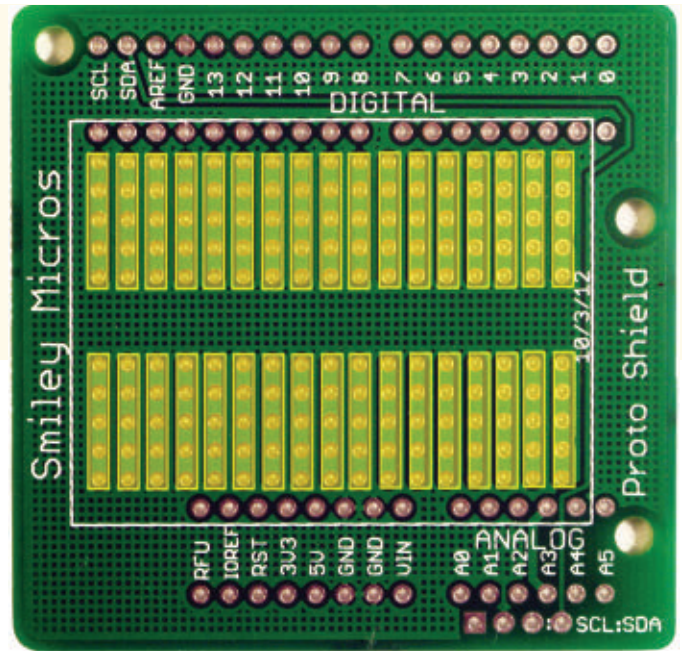

## ATTACHING THE MALE/FEMALE PASS-THROUGH HEADERS

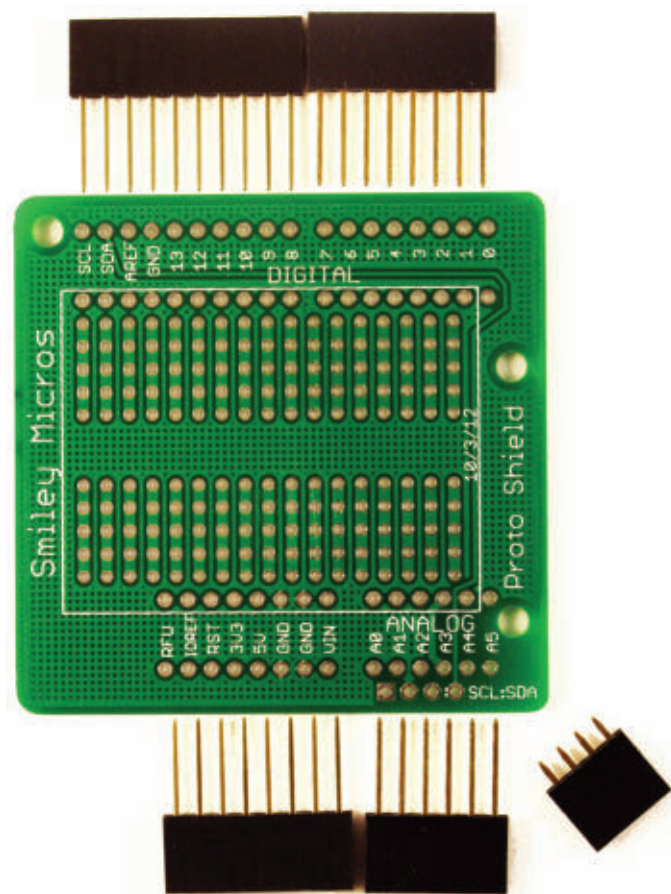

■ FIGURE 17. Male/female headers.

The proto shield comes with five headers. Four of the headers have long pins and are used to connect with an Arduino. The short four-pin header is used for I<sup>2</sup>C signals and will be discussed in a later article. You must be VERY careful when you are soldering the long pin headers since the pins are narrow and easily bent. If you bend these pins a couple of times they will almost certainly break, so it's best to get them perfectly aligned before soldering them.

Place the header from the top of the proto shield PCB with the pins passing downward through the holes. Make sure you use the correct header for the particular set of holes. (Look at **Figure 17** to see which header is matched to which set of holes.) Carefully make certain that the header is exactly perpendicular to the PCB, and then lightly solder only one pin. Visually inspect it to make sure that the pins are exactly 90 degrees to the PCB. Once you get these pins soldered in you won't be able to fix any problems, so make darn sure you've got them correct before you finish the soldering.

Once the pins are all soldered, VERY CAREFULLY place them onto the matching Arduino header sockets, visually inspecting this to make sure that you have exact alignment before gently pushing them into the Arduino. This is absolutely not the place for heavy handedness. With the pins pushed in place, it should now be easy to remove or reset the proto shield on your Arduino.

When you remove the proto shield, make certain that you store it in a way that won't bend the pins. Gently plugging it into a chunk of Styrofoam is probably your best bet.

## ATTACHING THE MALE ONLY NON PASS-THROUGH HEADERS

The headers shown in **Figure 18** are much easier to solder than the male/female headers. You simply insert these headers into an Arduino, then put the PCB on top and solder each pin.

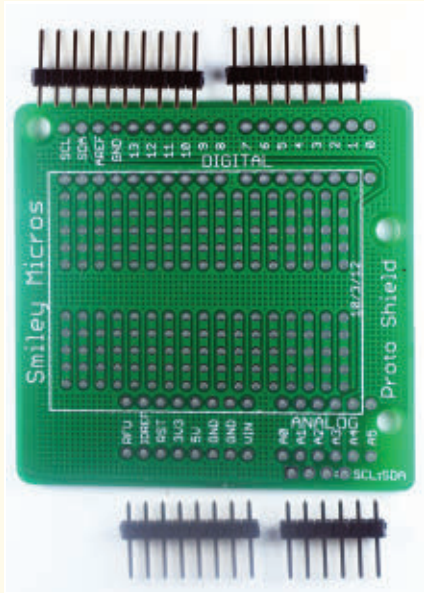

■ FIGURE 18. Male headers.

## HEADER PLACEMENT FOR SOLDERING

Note in **Figure 19** that we place the male/female pass-through headers through the top of the PCB so that the black plastic is all above the board. We do just the opposite for the male-only headers, where we place the short pins from the bottom of the PCB so that the plastic and the long pins are on the bottom.

These latter headers are easier to get straight since you can push them into the Arduino female headers and then lay the PCB on the pins so they are held in position before soldering.

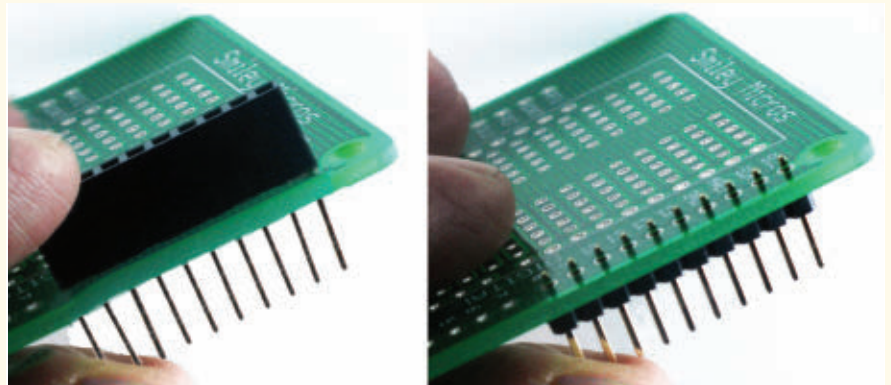

■ FIGURE 19. Header placement for soldering.

## ATTACHING THE BREADBOARD

We can use the PCB with or without the mini breadboard. If we want to use it with the mini breadboard, we can remove the yellow base coat from the bottom of the breadboard and stick it on where we see a box marked out in white; refer to **Figure 20**. Or, we can make it more reusable by leaving the yellow base tape coat on and using some double-sided sticky tape on the bottom of the breadboard (on top of the yellow base coat) as shown in **Figure 21**. This makes it easier to attach and detach. Either way, the final position of the breadboard should resemble **Figure 22**.

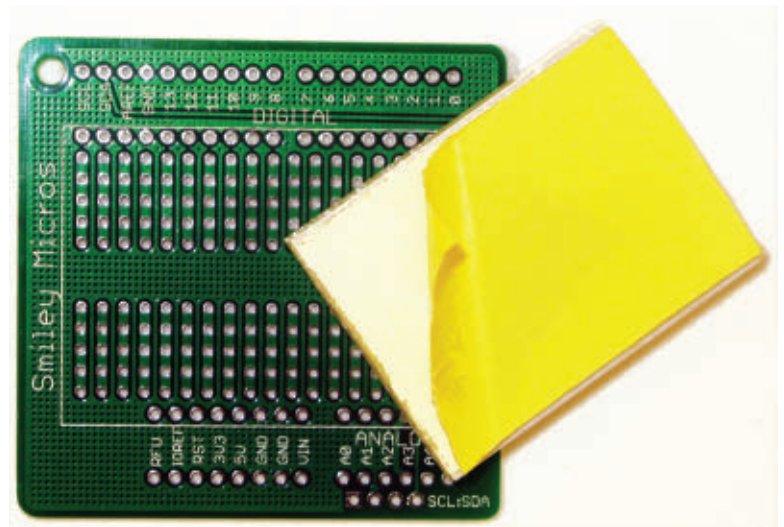

■ FIGURE 20. Foam tape backing.

## MOVING A DESIGN FROM THE BREADBOARD TO THE PCB

Last month, we built a DS1307 RTC (real time clock) based alarm clock on the breadboard. Referring back to **Figure 1**, it shows two proto shields: one with a breadboard containing components from last month's

project, and the other shows exactly the same components moved to and soldered on the PCB. The main difference is that on the breadboard version, the

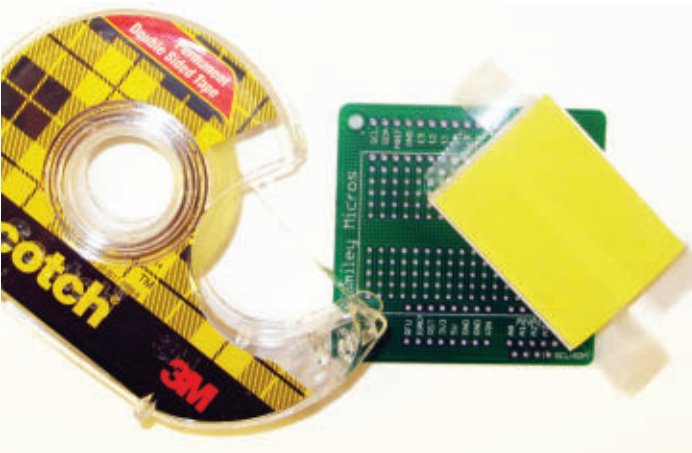

■ FIGURE 21. Using double-sided sticky tape on the base of the mini breadboard.

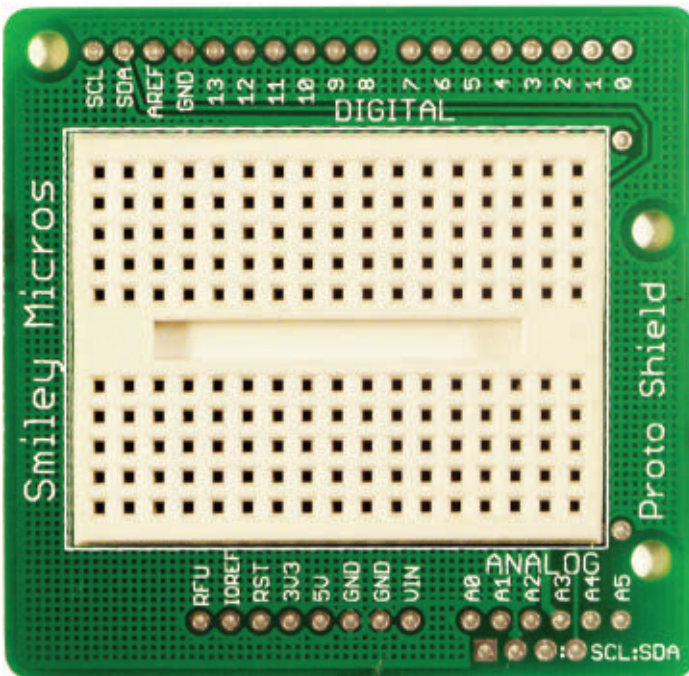

■ FIGURE 22. PCB with mini breadboard.

## USING THE ARDUINO ALARM CLOCK

Figure 23 shows the Windows dialog box for opening communications with the Arduino. If you've been following these Workshops for a while, you may notice the resemblance of this dialog to the one we created way back in Smiley's Workshops 18, 19, and 20 on serial communications (the January, February, and March 2010 issues).

wires go to the Arduino header, while on the PCB version the wires go to the matching second set of Arduino pins just inside the white box.

I recommend that you take a picture of your working breadboard design before moving the parts to the PCB. It would be even better if you have duplicate parts for your design along with two proto shield PCBs, so that you can keep the breadboard design handy to use for debugging your PCB version.

## ARDUINO ALARM CLOCK SOFTWARE

Generally with the Arduino, I like to reuse other folks' code as much as possible, but I was surprised that I didn't find a really useful alarm clock program. There were lots of similar projects, but none seemed to be doing the job I wanted. So, I decided to recycle some concepts we discussed a while back that are gone over in more detail in my book *An Arduino Workshop* (available from the *Nuts & Volts* webstore).

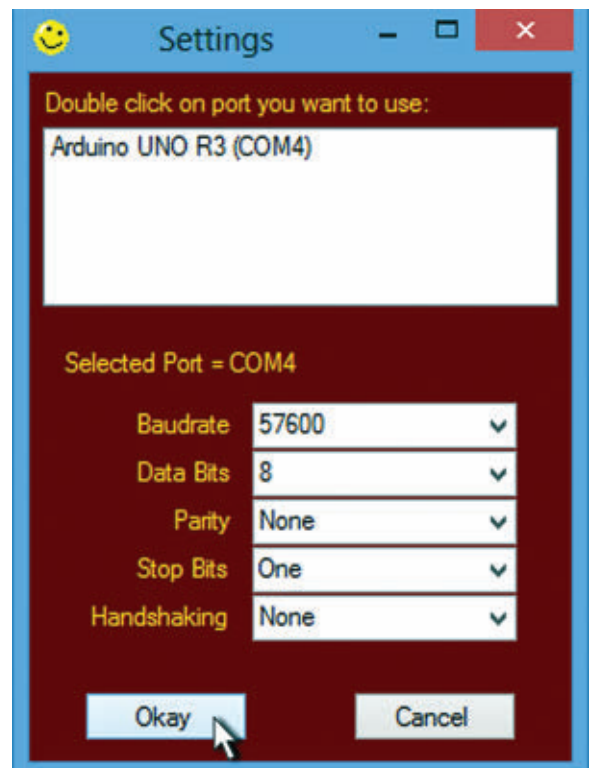

■ FIGURE 23. Open communications with the Arduino.



■ FIGURE 24. Arduino alarm clock application.

This dialog box and the alarm clock application shown in **Figure 24** are both built on top of C# Express software created in those Workshops.

We will briefly look at how to use this application, and then next month we will go into more depth on

how this software was written.

You can see from **Figure 24** that the Arduino alarm clock application is evenly divided into halves with the left for the 'PC Time + Date' and the right for the 'Arduino Time + Date.'

This program lets us use a PC to

communicate with our Arduino alarm clock, allowing us to set the date and time, and also five alarms.

These alarms can be either one shot that trip only once or daily (which will trip every day at the hour set).

Notice that the dates and times are shown in different formats on the PC and Arduino sides. The PC time is shown in a 12 hour format with either AM or PM; the Arduino time is shown in a 24 hour format.

The PC date is shown in the American standard way with the month/day/year, while the Arduino date is year/month/day.

These differences are because it is very easy to display the date and time in the common American format on a PC using C#, but is somewhat more difficult on the Arduino.

You have access to the source code, so you can rewrite it to display whichever way suits you.



GOD-LIKE ENGINEERS & PROGRAMMERS:

BUILD A 23<sup>RD</sup> CENTURY MEDICAL DEVICE

Butterfly Network is a fully-funded startup backed by entrepreneurs who have already shaped our future. Be at the intersection of Computer Science, Electrical Engineering and Medicine as we develop advanced diagnosis and treatment technologies that will transform medicine.



WANT TO CHANGE THE WORLD? JOIN US.

- FPGA and Embedded Design Engineer
- 3D Visualization Computer Scientist
- Device Driver and Software Engineer
- Signal and Image Processing Specialist
- Electrical Engineer or Applied Physicist

info@butterflynetinc.com | www.butterflynetinc.com

## BARGAIN SCOPES

**WORLD'S SMALLEST**  
 World's smallest MSO! This DIP-sized, 200KHz, 2-ch scope includes a spectrum analyzer and Arbitrary Waveform Generator. Measures only 1 x 1.6 inches in size! - XPROTOLAB \$49

**IPHONE SCOPE**  
 5MHz mixed signal scope adapter for iPhone, iPad and iPod Touch! FREE IMSO-104 app available from Apple App Store. - IMSO-104 \$297.99

**30MHZ SCOPE**  
 Remarkable 30MHz, 2-ch 250MS/s sample rate oscilloscope. 8-in color TFT-LCD and AutoScale function. Includes FREE carry case + 3 yr warranty! - SDS5032E \$299

**60MHZ SCOPE**  
 Best selling 60MHz 2-ch scope with 500MSa/s rate + huge 10MSa memory! 8" color TFT-LCD. Includes FREE carry case! - SDS6062 \$349

**100MHZ SCOPE**  
 High-end 100MHz 2-ch 1GSa/s benchscope with 1MSa memory and USB port + FREE scope carry case. New super low price! - DS1102E \$399

INCREDIBLE LOW PRICES, FREE TECHNICAL SUPPORT  
 EXCELLENT CUSTOMER SERVICE [WWW.SAELIG.COM](http://WWW.SAELIG.COM)

## OPEN AND CLOSE THE PORT

On the menu bar at the top of the application, you see the 'Select Device' and 'Open Port' menu items.

The Select Device will open the Setting dialog shown in **Figure 24**.

You can click on the 'Open Port' dialog that will toggle to 'Close Port' after you've opened it. If you are working with the Arduino IDE on that side of the code, you will need to close the port before you can upload your code to your Arduino from the Arduino IDE.

After your code has uploaded, you'll need to open the port for the application to communicate with the Arduino.

The black text window on the left side shows the messages that are *sent* to the Arduino marked by '>' and those *received* from the Arduino marked by '<.'

## WHAT DOES AN ALARM DO?

In our design, the alarm causes the piezo element to beep using the code discussed last month. It should be noted that you could easily rewrite the Arduino code so that the alarm can instigate any action an Arduino is capable of.

You could have it turn on the light by your bed, start the coffee pot brewing, and even turn on a hotplate with a skillet full of bacon (though that might be a bit dangerous).

## LAST BELL

This was a very brief introduction to the alarm clock software. We will go into greater detail next month. You can find links to this software at the article link. Questions? *Nuts & Volts* is hosting forums for its writers and you can find mine at <http://forum.nutsvolts.com>. **NV**



## NEW! Nuts & Volts Mobile App!

You can now enjoy *Nuts & Volts Magazine* on-the-go from your mobile device. Our new mobile app is now live and available for iOS, Android, and Kindle Fire devices.

Right now, you can find the latest issues in the brilliant replica format that you know and love, and also text formatted articles designed for maximum readability on any size screen.

You can download each issue and return anytime to read offline. *Nuts & Volts* print subscribers get free access to any issues that are included in their subscription and available within the app. Other back issues are available through a special in-app purchase feature.

**Check it out now at your favorite App Store!**

## The Convenient All-in-One Solution for Custom-Designed Front Panels & Enclosures



ONLY \$90.24 with custom logo engraving

**You design it** to your specifications using our FREE CAD software, Front Panel Designer

**We machine it** and ship to you a professionally finished product, no minimum quantity required

- Cost effective prototypes and production runs with no setup charges
- Powder-coated and anodized finishes in various colors
- Select from aluminum, acrylic or provide your own material
- Standard lead time in 5 days or express manufacturing in 3 or 1 days



FrontPanelExpress.com  
1(800)FPE-9060



### Bi-Directional Level Shifter

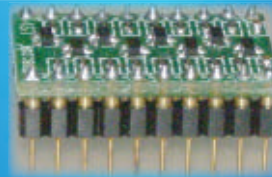

- Program in BASIC
- 32-bit integers
- 64-bit Floating Point
- Sin, Cos, Log and more
- String processing
- 30k RAM, 64k Flash
- \$59-95

- 8 Channel
- 3.3V to 5V
- I2C Compatible
- Only \$4-95

20% Discount with code "NUTS" at Checkout for January



Visit us today @ [www.EZSBC.com](http://www.EZSBC.com)

# QUESTIONS

WITH  
RUSSELL KINCAID

# & ANSWERS

In this column, Russ answers questions about all aspects of electronics, including computer hardware, software, circuits, electronic theory, troubleshooting, and anything else of interest to the hobbyist. Feel free to participate with your questions, comments, or suggestions. Send all questions and comments to: [Q&A@nutsvolts.com](mailto:Q&A@nutsvolts.com)

## VOLTAGE CONVERTER QUESTION

**Q** As a retired electrical contractor, I now have time to work in an area where I have very little experience. I have installed equipment with PLC (Programmable Logic Controller) controls and now have found time to experiment with them. I have installed a PLC to control my outside lighting, with motion detectors and wireless Christmas lighting controls. The PLC's have 24 volt DC inputs, but the motion detectors are 120 volt AC output, so I have experimented with the H11AA1 optoisolator for the 120 volt AC to 24 volt DC control.

The circuit I sent you has worked for now, but the voltage drop through the 2N222A is about four volts. The PLC will operate between 16 and 24 volts, but why a four volt drop? Is there a better way to do this?

— Al Bochter

**A** I actually redrew the circuit diagram you sent (Figure 1). The current through the gallium arsenide diodes in

the H11AA1 is about 20 mA, so the output transistor is fully turned on. I would expect the drop across the 2N222A to be one volt or less, unless the load current is over 500 mA.

I am not familiar with PLCs but assume that the 24 volt input is just a logic level and draws little current. If the load current was 500 mA or more, the transistor would get very hot. So if it is not hot, the only other thing I can suggest is that the .1  $\mu$ F cap is very leaky. Try taking it out; it is only slowing down the switching time. Oh! Switching! No doubt you are measuring the average of zero and 24 volts.

## BENCH TOP POWER SUPPLY

**Q** I give your column first priority when I receive my *Nuts & Volts*. I find it very interesting and it stimulates my thinking. I have a request which will take advantage of your demonstrated ingenuity

I came from a ham family. After WWII service, I got my own license, W0QKT. It was a vacuum tube world

then (1945). Later, around 1950, I began to start to understand and apply transistors ... particularly in R/C model airplanes and in an in-field duck caller.

To minimize the loss of transistors during my early clumsy experiments, I came up with a controlled power supply. In particular, it could be set not only for a given voltage out but also a max current limit. Its proper use saved many experimental transistors.

I have been using this supply consistently for 60 years. It was capable of max adjustable current settings of 5 to 25 mA with a second switched range of 30 mA to 200 mA. The voltage range was two to 40 volts.

It was crudely implemented with a high current series variable resistor, followed by a voltage adjustable high current shunt transistor. The approximate voltage and current settings were made by two labeled pots.

Just last week, my old supply went belly up and I really miss it. I'm used to setting a max current with all my circuits, including the buried cable exciter I sell on the net.

What a mess the old circuit is inside and there's no schematic. Some 20 or 30 years ago, Heathkit sold such a supply (I didn't need it then). I'm ready to make a new and classier one.

So, I am requesting a modern circuit design from you. It doesn't have to have the same specs as my

■ FIGURE 1.

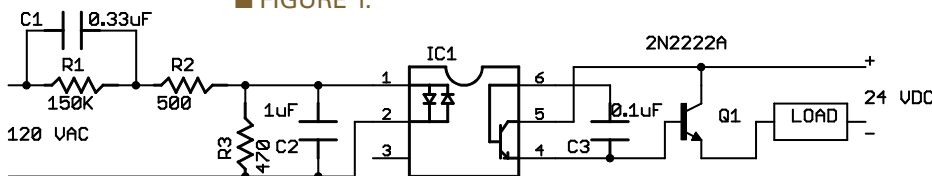



■ FIGURE 2.

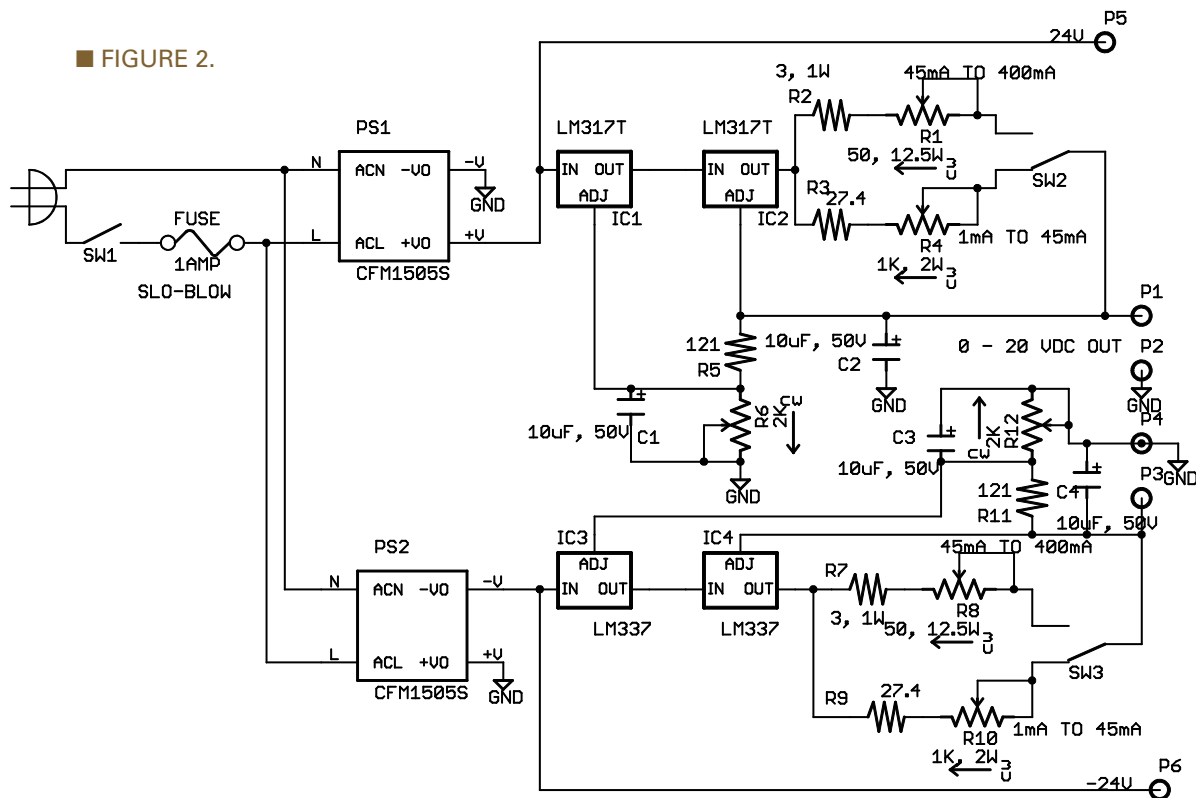

old one. A max of 24 volts and 150-200 mA would be great. (I once thought it would be ideal if it produced both plus and minus outputs, simultaneously.)

Thank you for all your past efforts. Looking forward to your design.

— **Walt Brackmann**  
**Brackmannengineering.com**

**A** My solution is in **Figure 2** and the Parts List is in **Figure 3**. It uses a universal AC input switching supply with an output of 24 volts. A 30 volt output would be nicer because the variable output could go to 24 volts, but to save costs I opted to tap the 24 volts directly when that voltage is

needed. The CFM1505S supply provides the voltage step-down and isolation while saving a lot in space and weight.

The variable voltage is provided by an LM317 positive regulator and LM337 negative regulator. The current limit is provided by another LM317 and LM337 regulator. When

**PARTS LIST FOR VIDEO SWITCH**

■ FIGURE 3.

PART	DESCRIPTION	PKG	PART NUMBER	PRICE EA
PS1, PS2	UNIVERSAL SWITCHING SUPPLY		418-CFM1505S	19.28
IC1, IC2	VARIABLE DC REGULATOR	TO-220	595-LM317KCSE3	0.53
IC3, IC4	NEGATIVE DC REGULATOR	TO-220	88K5437	0.77 NEWARK
C1, C2, C3, C4	10 µF, 20%, 50V	5MM	140-RGA100M1HBK0511G	0.08
R1, R8	50 OHM POT, 10%, 12.5W	PNL	588-RES50RE	27.52
R4, R8	1K POT, 10%, 2W	PNL	882-RV4NAYSD102A	13.12
R2	3 OHMS, 5%, 1W	1W	588-41F-3.0	0.44
R3	27.4, 1%, 1/8W	1/4W	71-CCF55-27.4	0.09
R5	121, 1%, 1/8W	1/4W	71-CCF55-121	0.09
R6, R12	2K POT, 1/2W	PNL	31VA302-F	1.55
R6, R12 ALT.	1.5K POT, 5%, 2W	PNL	785-53C31500	8.13
SW1, SW2, SW3	SPDT, 5A, SILVER	PNL	612-100-A1421	2.63
HEATSINK	3.4 DEG C/W, 2" HIGH		588-FA-T220-51E	1.96

ALL PARTS ARE MOUSER EXCEPT NEWARK AS NOTED; prices are subject to change.

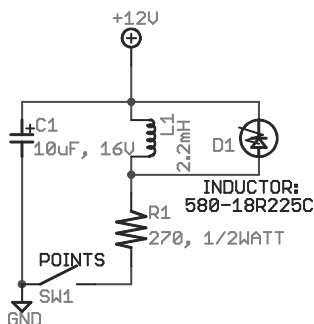

■ FIGURE 4.

the load current is less than the set current, the regulator is in saturation with minimum voltage drop. If the load tries to draw more than the set current, the output voltage reduces.

There are two pots controlling the current because all of the load current goes through the pot. In this case, the max current is 400 mA and the resistance to limit the current to 1 mA is 1.25K (1.25V/1 mA).

So, 400 mA squared times 1.25K = 200 watts; using a lower power rating would risk burning out the resistance element. Two watt pots are available and inexpensive, so if  $I^2 \cdot R = 2$  watts and  $R = 1,000$ , then  $I = 45$  mA.

The resistance to limit the current to 45 mA is 27.8 ohms, and the power in that resistor is 56 mW. The resistor to limit the current to 400 mA is  $1.25/.4 = 3.125$  ohms (use three ohms/one watt). I already know that the resistance to limit the current to 45 mA is 27.8 ohms, but 30 or 50 ohms are available; 30 ohms at 400 mA requires 4.8 watts (use five or 10 watts).

The DC/DC regulator needs 10 mA current to operate; that is provided by the bias resistors R5, R6, and R11, R12;  $R5 = 1.25V/.01A = 125$  ohms — 121 ohms is a standard 1% value that I stock. To be able to set 20 volts output:  $I = 1.25/121 = .0133A$ ;  $R6 = 20V/.0133A = 1504$  ohms.

A 1.5K pot is uncommon and

pricey, so I will use a 2K pot realizing that its full range will not be usable.

IC1 and IC3 will dissipate 7.6 watts when delivering 400 mA at five volts, so a 10 watt heatsink is indicated.

## TRIGGER LED FROM DISTRIBUTOR

**Q** I work on engines for pre-911 Porsches — the four cylinder 356 cars. I put together a testing machine that allows me to run distributors at speeds up to 3,500 rpm. This machine has a degree wheel I use with an ordinary automobile timing light to check the advance and see if there's any wobble or dither of the points.

To do that, however, I have to hook up a coil with some plugs and supply that coil with 12 volts. I'd rather just use the points to trigger an LED. This would flash four times per revolution instead of once, but that's okay; that would check the repeatability of the point's opening. So, I'm looking for a circuit I can connect to the points that will flash an LED when the points open. The pulse time at 3,500 rpm is 47 microseconds per degree; I think an LED can do that.

If you can suggest a circuit, I think I could wire/solder it up. Thanks!

— Curt Crowell

**A** The circuit I designed is in **Figure 4**. I think a super-bright clear LED would work best. Check out part #RL5-W8045 from **superbright leds.com**. R1 limits the current to 45 mA; when the points open, the current flows through D1 for about 25 µs. Using 1 mH for L1 will shorten the on time, and reducing R1 to 180 ohms/one watt will increase the brightness if needed. The inductor should be low resistance; Mouser #580-18R225C would work (rated 190 mA, 2.2 ohms).

## DIGITAL PRESSURE GAUGE REVISTED

**Q** Referring to the Q & A answer column for November 2012, page 22, Figure 7: Is it possible to use a substitute transducer with the schematic diagram that you designed? I noticed the main difference is the operating voltage.

I already have the Mouser part number 841-MPX4115AP on hand. Also referring to the schematic diagram, I don't know what part number IC1 is. Thanks in advance.

— Jeff Miller

**A** IC1 is NJM2370 — a five lead voltage regulator in a SOT89-5 package. Sorry about the omission. The Freescale part is a different animal than the Honeywell part.

The MPX4115AP has a range from 2.175 PSI (0.2 volts) to 16.675 PSI (4.8 volts). It does not go to zero, so there is no point to a zero adjust.

The sensitivity to power supply variation is not specified, so I suspect that it varies directly (1:1). As long as the supply is well regulated, the cal adjustment will take care of any deviation from 5.1 volts; see **Figure 5**. The voltage divider is designed to produce 0.2 volts output when the pressure is 15 PSI. If you want the meter to read 115 mV at 15 PSI, change R3 to 75 ohms.

My understanding of how this works is if the circuit is sitting on the bench — not connected to a vacuum pump — it will read 14.7 PSI.

As the vacuum is pulled, the pressure goes down to a minimum of 2 PSI. If you want the meter to read the other way, e.g., maximum volts at minimum pressure, use the circuit in **Figure 6**.

The inverting amplifier has a gain of one and the bias on the positive input is close to 2.5 volts which

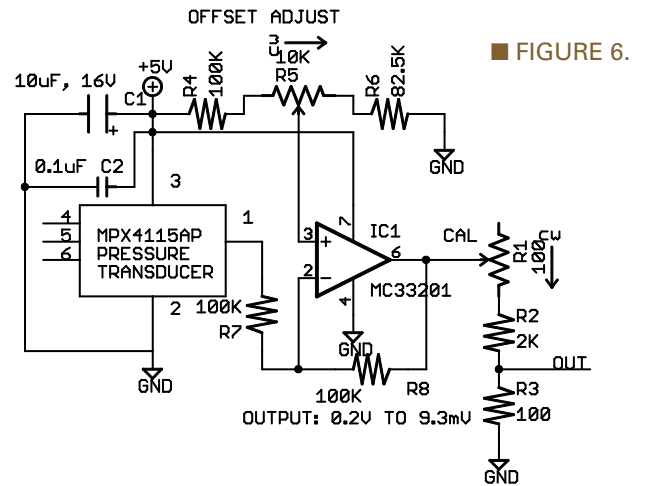
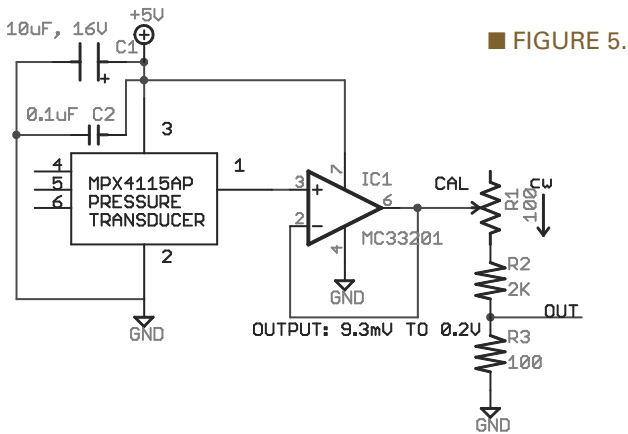

allows the output to pivot about that point.

For ease of adjustment, I suggest that you adjust cal for the desired span without regard to the actual voltages, then adjust the offset. **NV**

**Remember!**  
Send any questions and/or comments to:  
[Q&A@nutsvolts.com](mailto:Q&A@nutsvolts.com)

Superior Quality Soldering Tools from





NEW

FX-951

HIGH PERFORMANCE SOLDERING STATION

- Digital temperature display
- Superior heat transfer
- Fast thermal recovery
- 400°- 840°F (200°- 450°C)
- Low temperature alarm
- Sleep mode for longer tip life

FX-601

TEMP-ADJUSTABLE SOLDERING IRON

- Electronic "closed loop" control
- 464°-1004°F (240°- 540°C)
- Ceramic heating element
- Lightweight (2.4oz w/o cord)
- Extra long 3-plug, 6 ft.cord
- UL/CSA Approved

FX-888D

LOW COST, DIGITAL SOLDERING STATION

- Digital display (°F or °C)
- Adjustable temperature
- 120°-899°F (50°- 480°C)
- Idle temp within 1.8°F (1°C)
- Ergonomic, handpiece
- Ceramic heater

For complete information, visit [HakkoUSA.com/NutsVolts](http://HakkoUSA.com/NutsVolts)



# NEW PRODUCTS

- HARDWARE
- SOFTWARE
- GADGETS
- TOOLS

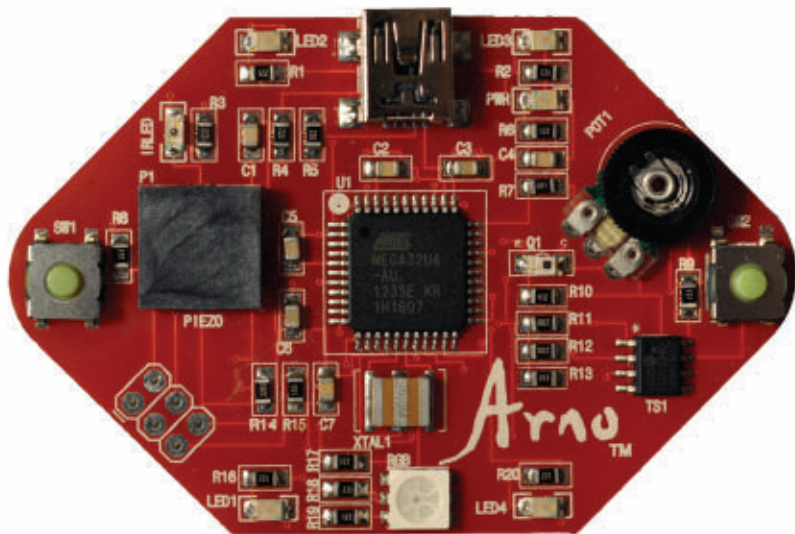

## ARNO KIT FOR ARDUINOS

The Arno Kit from Olympia Circuits is an innovative new approach to learning and teaching about Arduino. The Arno provides beginners with interesting circuits built right into the board, so they can focus on learning the basics of electronics and the Arduino language without needing to assemble and troubleshoot circuits.

The kit consists of the Arno circuit board and a new book that gives step-by-step instructions for more than 40 projects, without the need for external components and wiring.

Olympic Circuits' goal is to eliminate the barriers that keep many people from jumping into Arduino. The Arno is fully compatible with the Arduino programming language and integrated development environment (IDE).

The Arno board is based on an ATmega 32U4 processor from Atmel. To support learning projects, the following devices are integrated onto the board:

- Four green LEDs.
- One RGB LED.
- One infrared LED.
- Two momentary pushbutton switches for digital inputs.
- One thumbwheel

potentiometer to introduce analog measurements and controls.

- One piezo element to create tones and measure vibrations.
- One phototransistor to detect infrared and visible light.
- An I<sup>2</sup>C digital temperature sensor to introduce between-device digital communication.

The included book *Learning Arduino with the Arno* gives all the information needed to move into advanced projects. It won't send users to the Internet looking for help; instead it is a thorough text to teach a wide range of programming concepts.

It starts with introductions to electronics and programming, then provides code and explanations for over 40 projects using the Arno board, as mentioned previously.

The projects range from common beginner programs like "blink," to more complex concepts using multiple inputs and outputs.

With its wide variety of built-in components, the Arno can also be used to quickly test code.

For more information, contact:  
**Olympia Circuits**  
Web: [www.olympiacircuits.com](http://www.olympiacircuits.com)

## AFFORDABLE RF MODULES

Lemos International has launched a new line of affordable low-power 2.4 GHz radios. The LMX-ISM-242 series of 2.4 GHz data radios are available in DIP and SMD configurations. A long-range version

— the LMX-ISM-242-LR — is also available.

All of the LMX-ISM-242 radios operate in the 2.40 GHz-2.4835 GHz segment of the license free industrial scientific and medical band. All members of this LMX family feature programmable output power and data rate. Low voltage operation

between 1.9 and 3.6 volts allows the LMX data radios to easily fit in embedded applications.

Configuration information and payload data are passed to and from the LMX radio via an industry standard 8 MHz four-wire SPI interface.

The LMX-ISM-242 line is



supported by the LMX development kit which includes hardware and firmware support for all of the LMX-ISM-242 variants.

The development kit comes loaded with an LMX driver and demo code to get your project up and operational in the shortest amount of time.

Lemos International also offers a programmable LMX data radio module that consists of either a standard LMX-ISM-242 or LMX-ISM-242-LR data radio under the control of a powerful microcontroller.

The LMX family's small form factor makes any LMX data radio a perfect fit for the following applications:

- Scientific Telemetry
- Building Security
- Remote Monitoring
- Remote Control
- Home Automation
- Consumer Electronics

The LMX series and the development kit are available now.

For more information, contact:  
**Lemos International**  
 Web: [www.lemosint.com](http://www.lemosint.com)

## IPHONE-ENABLED WIRELESS MULTIMETER

**S**aelig Company, Inc., announces the availability of iDVM – an iPhone-enabled multimeter that wirelessly connects to an iPhone, iPad, or iPod Touch that allows users to acquire, visualize, and share electrical measurements. The iDVM app – with its familiar appearance of a standard digital voltmeter – can be downloaded for free from Apple.

iDVM allows a user to log data over an extended period of time using an iPhone or iPad as an electrically isolated storage device. Service engineers could use iDVM to collect data and store it in a report for submission to clients, or retain the data on the voltmeter for their own records. Using the GeoTag feature of the iPhone or iPad, engineers can even identify their location as part of the data.

This unique voltmeter measures voltage, current, and resistance. iDVM wirelessly links to the Apple devices to function as an interface to electrical measurement acquisition. Users can acquire data, save it, email it, post it to a web server, or display it for further visualization. Using the iOS integrated speech function, iDVM can even "speak" the measurement through the iPhone/iPad integrated speaker or earphones.

Apple's typical user interface allows the pinch, pan, zoom, and scroll of data. iDVM features internal rechargeable batteries for additional economy, and iDVM is an ideal solution for making isolated measurements at up to 30 meters.

Product features include:



- Measurement range: AC/DC volts 0-300V; AC/DC current 0.1-4.0A; resistance: 0-4 megohms.
- Functions: Autorange/Min/Max/Avg/Hold/Continuity (Beep).
- User definable data acquisition rate up to 20 Hz.
- Data export via standard formats CSV, SQLite, and graphics files .PNG or .PDF.
- Customizable graphing functions (e.g., graph scales, colors).
- Operating temperature: -10°C to +35°C.
- Size: 2.75" x 4.75" x 1.1".
- Weight: 350 g 12.3 oz.
- Uses USB rechargeable batteries.
- Complies with AANSI/ISA S82.02.01, IEC 61010 to 300V Overvoltage Cat III.
- Input impedance: 10 megohms.

iDVM is suitable for a wide range of users, from automotive technicians, embedded systems engineers, electrical and building contractors, to field service techs. It's made by Redfish Instruments.

For more information, contact:  
**Saelig**  
 Web: [www.saelig.com](http://www.saelig.com)

## DELUXE BASS BIG MUFF PI

**E**lectro-Harmonix's new deluxe bass Big Muff is the latest in a

line of bass specific effects, and delivers enhancements to the classic bass Big Muff Pi that is specifically tailored to the needs of the modern bass player.



The new pedal adds to the bass Big Muff's volume, tone, and sustain controls beginning with a pad on the input that is switchable between 0 dB and -10 dB. This ensures that the pedal is equally effective with both passive and active pickups.

Blend allows the player to mix to taste the direct and distorted signals. With three outputs – a 1/4" effect out, 1/4" direct (buffered dry) out, and XLR DI out – players have complete control of their output signal and sound. A built-in noise gate with adjustable threshold eliminates unwanted hum.

The foot-switchable crossover section with a variable low-pass filter on the dry signal and a variable high-

pass filter on the distorted signal gives bassists the ability to sculpt their sound. This crossover circuit – in conjunction with the blend – also enables the player to keep the low end clear and focused with the low-pass filter, and the high end bright and cutting with the high-pass filter.

The new deluxe bass Big Muff pedal is housed in a solid die-cast package and is equipped with a nine volt battery, can be powered by an optional standard 9.6 volt/DC 200 mA AC adapter, and carries a US list price of \$153.20.

For more information, contact:  
**Electro-Harmonix**  
 Web: [www.ehx.com](http://www.ehx.com)

## RGB PIXEL CONTROL LIGHTING

**E**nvironmental Lights has launched a new family of individually addressable RGB LED pixel lighting. PixelPro LED lighting combines the

ability to produce millions of colors with the technology needed to achieve individual pixel control.

According to Alicia Cheng, Director of Product Development, each RGB module can be individually controlled at the same time which allows for creative freedom when the



LED lighting is paired with any DMX controller or light board control system. The RGB PixelPro line comes in an assortment of RGB LED pixel strip and modules in various shapes and sizes. Environmental Lights currently offers RGB PixelPro in five configurations: square, bullet, circular, dome, or strip (waterproof and non-waterproof).

PixelPro LED modules combine RGB LEDs with an intelligent WS2801 integrated circuit (IC) chip to produce eye catching animated effects. There is one IC chip per module and one IC chip per LED on the strip lights. The pixel "bullet" or mini dome shapes (8 mm) are sold in strings of 50 and can be pushed through a display board to have the lights exposed for creating patterns with the light.

The 30 mm circle (three RGB LEDs) and 40 mm square modules (four RGB LEDs) are bigger and brighter, and are more suitable for animating backlit panels. They are sold in 20-module chains with about eight inches of wire between the modules, so they can be spliced easily at any point.

The biggest size are the 50 mm dome modules that can be used for exposed pixel board design because of their diffused plastic waterproof construction.

All the modules come with connector plugs on the input and output of the strings. Module strings can be easily linked at the beginning and end using the built-in connectors. Built-in mounting tabs with screw holes make installation simple with pixel LED modules and flexible wire.

The DMX512 pixel decoder is specifically designed to control digitally addressable RGB LED pixel lights using standard DMX512. It is capable of addressing individual LED nodes when used in conjunction with any of the RGB PixelPro strips or modules.

For more information, contact:  
**Environmental Lights**  
 Web:  
[www.environmentallights.com](http://www.environmentallights.com)

# EXPANDED LINEUP OF 32-BIT GENERAL-PURPOSE MICRO CONTROLLERS

Fujitsu Semiconductor America has introduced a new FM4 family of 32-bit general-purpose RISC microcontrollers based on the ARM® Cortex™ M4 processor core, featuring DSP and floating point (FPU) functions.

In addition, Fujitsu is introducing a new FM0+ family of devices based

on the Cortex-M0+ core.

The Fujitsu FM3 family, originally introduced in 2010, now includes 463 products. With the introduction of the FM4 and FM0+ families, Fujitsu will offer more than 700 ARM-based devices featuring a consistent architecture and maximum design

Continued on page 78

## SHOWCASE

Recycling & Remarketing High Technology

# WEIRDSTUFF<sup>®</sup> WAREHOUSE

Software, Computers, Electronics, Equipment, Doohickies

WE BUY/SELL EXCESS & OBSOLETE INVENTORIES

FREE COMPUTER AND ELECTRONIC RECYCLING

GIANT 10,000 SQ. FT. AS-IS SECTION

384 W. Caribbean Dr.  
Sunnyvale, CA 94089

Mon-Sat: 9:30-6:00 Sun: 11:00-5:00  
(408)743-5650 Store x324  
[WWW.WEIRDSTUFF.COM](http://WWW.WEIRDSTUFF.COM)

### PIC training course and development board

Easy-to-follow assembler and C tutorials introduce PIC programming, for baseline and mid-range PICs, through dozens of hands-on examples.

Ideal for beginners!



- Includes:
- Purpose-designed training and development board
  - CD containing all lessons and source code
  - five PIC devices
  - every component needed to complete each example

Fully assembled: \$89  
or in kit form: \$69

[www.gooligum.com.au](http://www.gooligum.com.au)

# QKITS.COM

USB Tutor Module

Make your first steps into the PC-USB world! Using this tutor module, learning how to master USB communication with the outside world becomes simple!

Examples and tutorial in Microsoft Visual Basic, C++, and C# editions.

**\$82.95**

Quantity discounts available.

1-888-604-KITS

NKC electronics

owon PREMIUM Distributor

# OSCILLOSCOPES

visit: store [NKCElectronics.com/owon](http://NKCElectronics.com/owon)

**SDS7102V**

100 MHz 2-Channel  
1 GSa/s Sample Rate  
10M Record Length  
8" 800x600 TFT Display  
USB - VGA - LAN

**PDS5022T**

25 MHz 2-Channel  
100 MSa/s Sample Rate  
8" 640x480 TFT Display  
USB Interface

**HDS1022M-N**

20 MHz 2-Channel  
100 MSa/s Sample Rate  
Handheld with Battery  
3.7" 640x480 TFT Display

Like **ARDUINO**? Try **Adrenaline!**

### It's Arduino with features.

128x64 Graphic LCD  
CAN network - boards together  
2 Light Sensors  
Buzzer

Instant Adaptors :  
MIDI, RS232,  
CAN, Wifi  
and more.

\$159

Actual product is different than shown

Direct Connect : [www.beyondkinetics.com](http://www.beyondkinetics.com)

Up to 8 RC Servos - OR -  
8 Bidirectional DC motors.  
2 Sonars.  
3 Lasers, Relays.  
LED bar

Program from the familiar Arduino dev environment

# www.Primecell.com

## Battery rebuilding service

Dead Batteries? Don't toss them.  
Send them to us - our rebuilds are better than original specifications.

**Tools**

Hilti Skil  
Milwaukee  
Panasonic  
B&D DeWalt  
Makita All  
2-36 Volts

**Electronics**

Bar Code  
Scanners  
Surveying  
Printers  
Laptops  
Photography

**Radios**

APELCO  
UNIDEN  
G.E. ICOM  
KENWOOD  
MOTOROLA  
MIDLAND  
MAXON  
YAESU  
ALINCO

Visit [www.primecell.com](http://www.primecell.com) for important details

24 Hr Secure recorder tel-fax (814) 623 7000  
Quotes email: [info@primecell.com](mailto:info@primecell.com)  
Cunard Assoc., Inc. 9343 US RT 220 Bedford PA 15522

# makerplot™

Data Acquisition and Graphical Plotting Software For Microcontrollers

- Works With Popular Microcontrollers
- Plots & Logs Analog & Digital Data
- Bi-Directional Data Acquisition & Control
- Interfaces Like These Come Standard
- No proprietary hardware required
- Completely Customizable
- "Make" Your Own Custom Interfaces
- Dozens of Full-Color Menus, Buttons, Switches, LEDs and Analog Controls To Choose From

Got Data? - MakerPlot It!™

\$ 39.00 - Single User License  
\$199.00 - Lab Pack License

[www.makerplot.com](http://www.makerplot.com)

# SDPSI

sdp-si.com  
800-819-8900

FREE CATALOG

Small Mechanical Components

SETTING IDEAS INTO MOTION

# ROBOT POWER™

Extreme Motor Speed Control!

MegaMoto - Motor Control for Arduino™

- ♦ 6V-28V - 13A / 30A peak
- ♦ Single H-bridge or dual half
- ♦ Current and Temp protected
- ♦ Jumper select Enable and PWM pins
- ♦ Up to three units stack on one Uno/Duemilanove

Dalf - \$250

- ♦ Closed-loop control of two axes
- ♦ Windows GUI for all features
- ♦ Full PID position/velocity loop
- ♦ Trapezoidal path generator
- ♦ Giant Servo Mode!
- ♦ [www.embeddedelectronics.net](http://www.embeddedelectronics.net)

>> Also H-bridges, gearmotors, plans, schematics <<

## www.robotpower.com

Phone: 253-843-2504 ♦ [sales@robotpower.com](mailto:sales@robotpower.com)



# THE SIRIUS METRONOME FOR THE SERIOUS MUSICIAN

By Thomas Henry

**One of the most important tools any musician needs is a metronome. Its purpose — of course — is to lay down a precise time frame within which a composition will be rehearsed. Yes, accurate tones in pitched music matter tremendously, but so does the timing and pacing of those notes. This is especially true when more than one player gets together.**





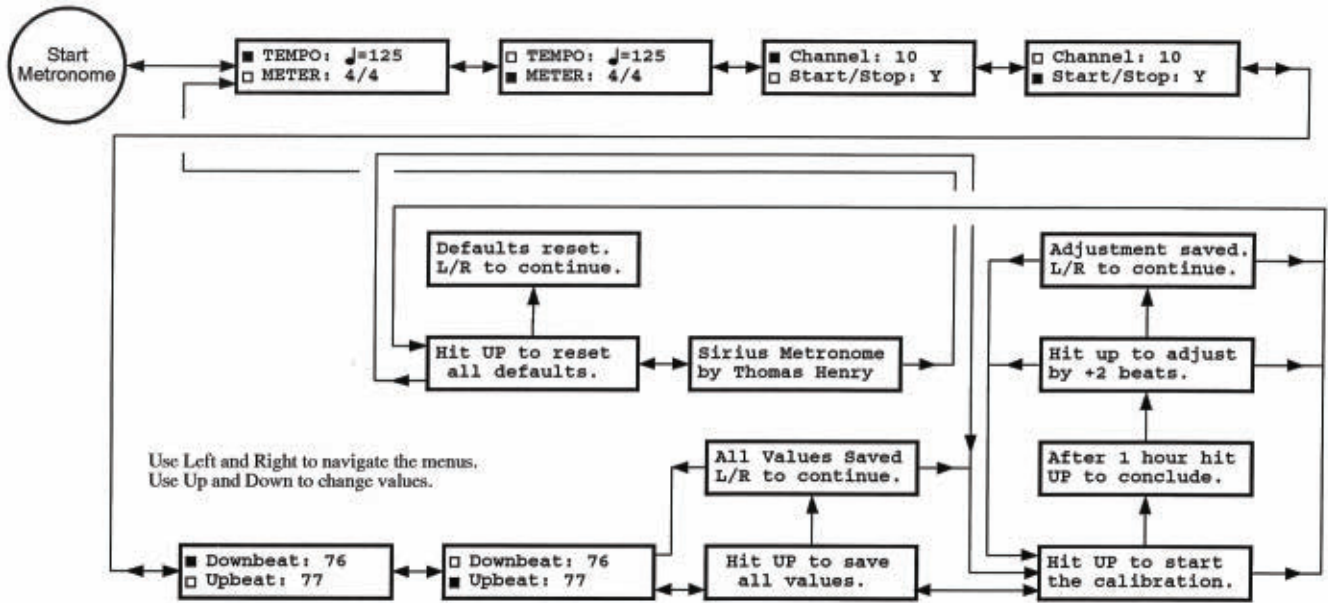

■ FIGURE 1. Menu structure of the Sirius Metronome.

The earliest metronomes were clockwork mechanisms, but with the advent of solid-state electronics, there are all sorts of new options for units with no moving parts.

The trouble with most DIY affairs that I've seen in the past is that they're based on overly-simple analog circuitry. They almost always drift with time or temperature, and are darn near impossible to calibrate decently. Commercial units may be better in that regard, but often produce cheesy electronic beeping sounds that puts one out of the mood, or aren't loud enough to cut through the din of a practice session.

Enter the Sirius metronome for the serious musician!

This neat circuit sports a number of interesting features that make it a delight to use:

- Exceedingly accurate, both short term and long term.
- Automatic self-calibration.
- One watt internal amplifier is beefy enough for most situations.
- Satisfying natural woodblock effect.

- Different sounds for upbeat and downbeats.
- Line output permits it to be connected to louder external amplifiers.
- MIDI output for even more instrument sounds.
- LCD display with a convenient menu system.
- Visual indication of downbeats (red) and upbeats (green).
- Plus lots of other niceties.

At the heart of it all is the common and inexpensive PIC16F88 microcontroller chip. Before you wince and think this is going to be difficult or expensive to deal with, hold on! The relatively sophisticated firmware is prepared with the excellent and easy-to-use Great Cow Basic compiler which I described in the November 2012 issue of *Nuts & Volts*. Recall that the price is zilch; this superior piece of software is absolutely free of charge, so there's no reason why you can't customize the metronome to your own liking without breaking the bank.

Let's take a moment to see what the menu structure looks like. This

will help you understand the many first-class features available within this unit.

## Close-up on the Menu

Our Sirius metronome has four pushbuttons labeled left, right, up, and down. These are used to navigate the menu system. Left and right take you from one menu to the next, while up and down are used to change the pertinent values within each menu. To ease the entry of large numbers, pressing and holding up (for instance) causes the values to increase by tens.

Check out **Figure 1** which shows how the menus are organized. The firmware to implement this structure is actually a state machine. Once you enter a given state (menu), various options become available until you leave that state. As a consequence, the firmware contains a ton of GOTO statements, but by using **Figure 1** as a guide, I had no trouble keeping things straight when composing the code. If you wish, you can laminate this chart and let it act

## GM DRUMS

The General MIDI protocol allows for many different musical sounds — from orchestral instruments to electronic effects. The percussive instruments are organized within Channel 10. If you're connected to a GM instrument like a synthesizer or even a computer sound card, you may choose any of the following for the downbeat and upbeat sounds.

- 35 Bass Drum 2
- 36 Bass Drum 1
- 37 Side Stick
- 38 Snare Drum 1
- 39 Hand Clap
- 40 Snare Drum 2
- 41 Low Tom 2
- 42 Closed Hi-hat
- 43 Low Tom 1
- 44 Pedal Hi-hat
- 45 Mid Tom 2
- 46 Open Hi-hat
- 47 Mid Tom 1
- 48 High Tom 2
- 49 Crash Cymbal 1
- 50 High Tom 1
- 51 Ride Cymbal 1
- 52 Chinese Cymbal
- 53 Ride Bell
- 54 Tambourine
- 55 Splash Cymbal
- 56 Cowbell
- 57 Crash Cymbal 2
- 58 Vibra Slap
- 59 Ride Cymbal 2
- 60 High Bongo
- 61 Low Bongo
- 62 Mute High Conga
- 63 Open High Conga
- 64 Low Conga
- 65 High Timbale
- 66 Low Timbale
- 67 High Agogo
- 68 Low Agogo
- 69 Cabasa
- 70 Maracas
- 71 Short Whistle
- 72 Long Whistle
- 73 Short Guiro
- 74 Long Guiro
- 75 Claves
- 76 High Wood Block
- 77 Low Wood Block
- 78 Mute Cuica
- 79 Open Cuica
- 80 Mute Triangle
- 81 Open Triangle

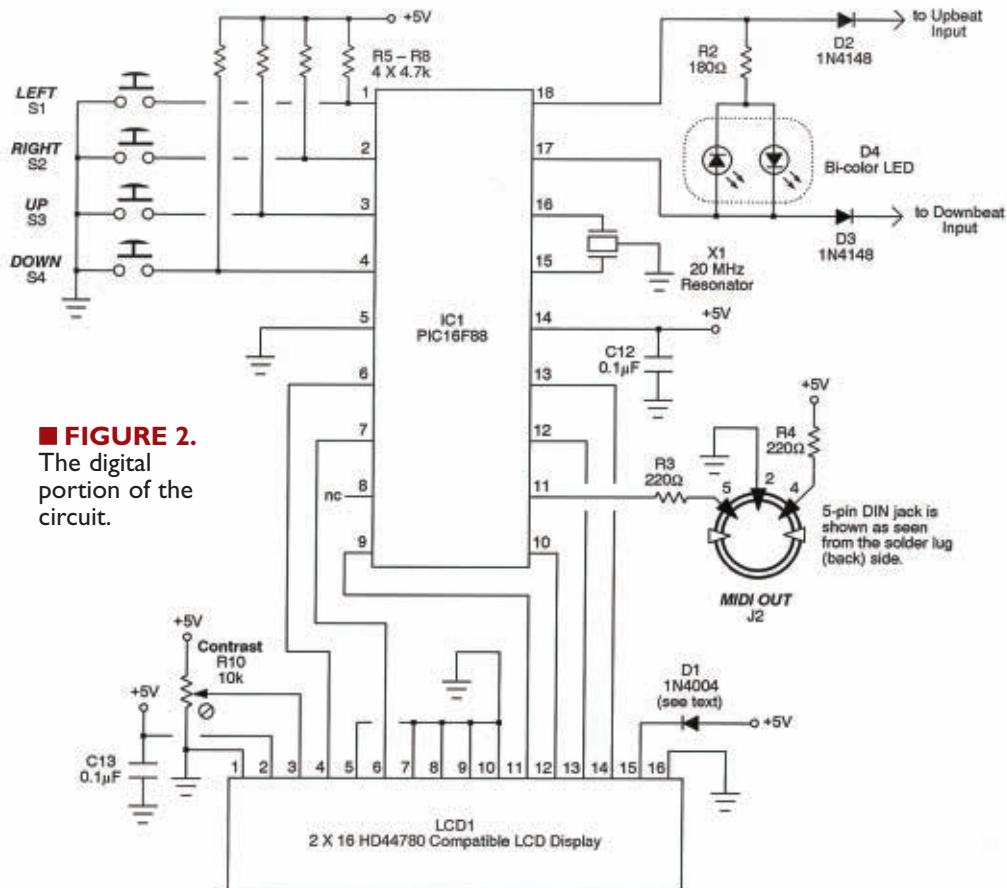

■ **FIGURE 2.**  
The digital portion of the circuit.

as your user guide. (A file is available at the article link.)

You can study it on your own, but let's take a broad look at some of the capabilities. The first two menus let you set the tempo and meter using standard music score notation. Tempo is indicated in quarter notes per minute and may range from 10 (very slow) to 240 (very fast). The numerator and denominator of the meter may be set independently.

The former can span one to nine beats per measure, while the latter may be specified in either quarter notes or eighth notes. While most popular music will perhaps hone in on 4/4 time, the ability to accommodate Brubeck, Mussorgsky, or Stravinsky is definitely there!

The next several menus let you adjust the various MIDI capabilities. This includes setting the MIDI channel that the Sirius will transmit on, whether a synchronizing MIDI start and stop byte should be sent, or MIDI note numbers to

be used for the downbeat and upbeat.

Typically, you'll want to connect to a General MIDI (GM) device on Channel 10, since this is where all of the percussive instruments reside. I've defaulted the note numbers to 76 and 77 which correspond to high woodblock and low woodblock sounds, respectively. Remember, there are 40 some other drums you could use; the **sidebar** shows what's available.

In the next menu, you have the option of saving any values you've changed so far in non-volatile memory. The next time you power up the unit, you'll resume right from where you left off. This is made possible by dint of the fact the PIC16F88 contains a goodly chunk of EEPROM right within the chip.

Now, the next menu is the coolest of all; this invokes the auto-calibration mode. Upon pressing the up button, the metronome begins playing at its fastest rate. You let it keep playing for exactly one hour, pressing the up button again to

conclude. (Use an ordinary clock with a second hand or your computer's clock to tell you when an hour has passed.) After this, the firmware does an internal calculation to determine how many beats — plus or minus — the timebase needs to be corrected for. It stores this correction in non-volatile memory.

Do the auto-calibration several times in a row to attain dead-on accuracy. The first time I ran mine, the timing was under by nearly 500 beats in an hour. The next time it was over by three beats. The third time it was perfect — exactly the correct number of beats in one hour.

Let me emphasize — Sirius does all of the work for you. There is no need to count beats, manipulate numbers, or anything else. The proper correction factor will be computed and stored in EEPROM, and you'll never have to calibrate again.

If, for some reason, you'd like to restore the metronome to its default state, the next menu let's you do so. All of the defaults are reset in the non-volatile memory. It's as though you're turning the unit on for the very first time after construction.

The last menu simply shows an "About" screen, displaying the name of the project and the author. (I always wanted my name in lights!)

We still haven't seen how to start the metronome, so keep moving left or right until you get to the very first menu which shows the meter and tempo. From this state, pressing the left button starts the unit. Press it again and the metronome stops.

## Bring on the Digital

Our metronome is a hybrid affair: half digital and half analog. The digital portion appears in the schematic in **Figure 2**. Refer to it now. As mentioned, the brains of the thing is the PIC16F88 which is a very easy-to-use and forgiving microcontroller. For good accuracy, we'll clock it at 20 MHz using

ceramic resonator X1. This connects to pins 15 and 16, with the center pin grounded.

The four momentary pushbuttons connect to port inputs A.2 through A.5 (pins 1 through 4). Note the pull-up resistors R5 through R8 which keep the port pins in a known state when no button is pressed. Also observe that the switches have a common ground connection which simplifies the wiring somewhat.

D4 is a two-lead, bi-color LED. When current flows in one direction it shines red; in the other direction, it lights up green. R2 limits the current to a safe value, either forward or backwards. As hinted at earlier, the LED blinks red on the downbeats (start of a measure), then blinks green for the remaining upbeats in the measure. By the way, 180Ω may seem to allow too much current to pass. However, the LED only flashes for 50 mS on each beat so it's

perfectly safe to push the limit here, and thus get a nice bright visual indication of your location in a measure.

Since this is a menu-based project, we'll turn to an LCD to provide the human interface. Here we have a typical two line by 16 character display, modeled around the HD44780 controller element. Don't let this gobbledygook put you off; almost all common displays follow this protocol, including the great bulk that you find at surplus houses for peanuts. I wanted something a little fancier for this project and went with a white-on-blue unit I picked up from Amazon for less than \$10.

Now, a word about the backlight on the LCD. These are generally a series-parallel combination of a couple dozen LEDs that light up the display nicely, making it visible in darker surroundings. You will



# EARN MORE MONEY Get your dream job!

## Be an FCC Licensed Radio Technician!

### Make up to \$100,000 a year and more with NO college degree

**Get your "FCC Commercial Radio License" with  
our proven Home-Study Course!**

- No costly school. No classes to attend.
- Learn at home. Low cost!
- No experience needed!
- GUARANTEED TO PASS - You get your FCC License or money will be refunded!



Turn your interest in electronics into a high paying career in Communications, Radio, Television, Avionics, Marine, Radar, Safety, Municipal and more... even start your own business!

**Call now for FREE info: 800-932-4268**  
Or, email us: [info@LicenseTraining.com](mailto:info@LicenseTraining.com) ext. 209  
**www.LicenseTraining.com**

**COMMAND PRODUCTIONS, Warren Weagant's FCC License Training**  
Industrial Center, 480 Gate Five Rd., PO Box 3000, Sausalito, CA 94966-3000

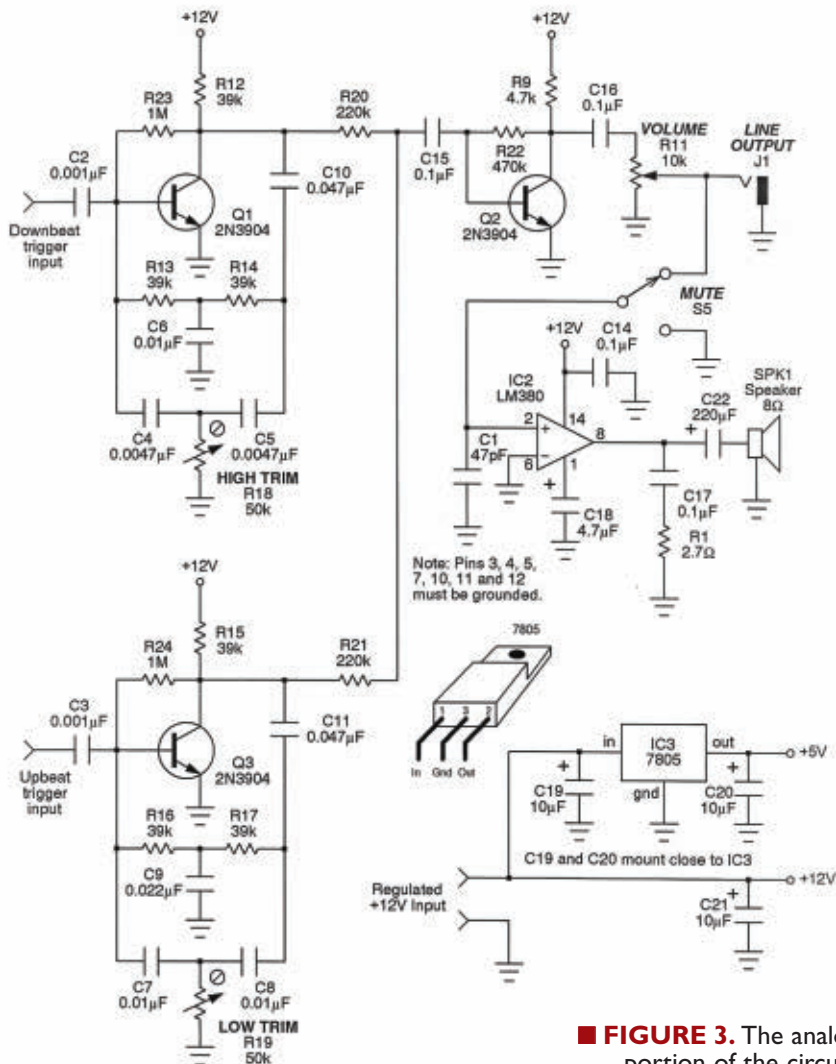

■ **FIGURE 3.** The analog portion of the circuit.

typically need to drop the voltage applied to the anode (at pin 15 of the LCD) by a small amount. Sometimes this is done with a resistor, but the unit I employed specified a rectifier which drops about 0.7V, bringing the current flow down to a safe value. Refer to the spec sheet for whatever you use.

To wrap up this discussion on the LCD, the PIC16F88 provides two control signals (pins 6 and 7 of the PIC) and four data lines (pins 9, 10, 12, and 13). The contrast of the LCD is adjusted by trimmer pot R10.

Great Cow Basic makes it a piece of cake to provide the MIDI output signals using the PIC's internal serial USART (universal synchronous

asynchronous receiver transmitter). Trust me, the compiler makes this so easy, you really don't have to know a thing about the messy details. The output appears at pin 11 of the PIC, and R3 and R4 create the usual current loop required by MIDI.

## Now for the Analog

Figure 3 shows the analog circuitry needed to get this creature pulsing. Remember, we have two different sounds available: one for a downbeat (higher pitched) and one for the upbeat (lower pitched). Other than the capacitors used to set the pitch, the sub-circuits to generate the

woodblock sounds are identical. So, let's focus on the downbeat portion surrounding transistor Q1.

At the core of the sound generator is a very high gain filter – almost at the point of self-oscillation. The filter network is the traditional Twin-T configuration. One of the "tees" is comprised of R13, R14, and C6. The other "tee" is made up of C4, C5, and R18. Trimmer R18 brings the filter close to (but not at) the point of oscillation. Thus, the circuit is just sitting there, teetering on the brink of yelping.

When a pulse from the PIC hits it (by way of C2), the system is disturbed and the filter begins to ring, dying off again in a moment. What we've created is a damped sinusoid – a wave that briefly comes on full-tilt, smoothly falling off to silence again. Remarkably, that's what a woodblock does when you strike it with a stick. Thus, we get a nice woody effect that sounds like an acoustic percussive instrument.

If you want to lower the pitch, then increase C4 and C5 (but keep them equal), and let C6 be double that value. The upbeat circuitry behaves similarly. So, feel free to customize the tones of these; the values I've used sound most appropriate to me.

The outputs of both the downbeat and upbeat oscillators are summed by R20 and R21, and sent to a simple preamplifier configured around transistor Q2. This then goes to volume control R11 and then to the line output at jack J1. The signal level is around 1 Vpp, making it suitable for running to an external instrument amplifier if desired.

Otherwise, the wiper of the volume control continues on to the internal amplifier built up around the ubiquitous LM380 chip. Running this chip on a +12V supply and applying it to an 8Ω loudspeaker gives a very usable one watt or so of power.

While IC2 may not be the most distortion-free amplifier chip around, here it works very well. Since we're generating percussive sounds,

distortion simply isn't an issue and for all I know may actually improve the replication of a real stick striking wood.

One last thing about IC2. Normally, when using this part at one watt, a heatsink would be required. In fact, I started by using one on the breadboard and couldn't help but note that it was dead cold all the time. That's because the amplifier is responding to percussive signals and is essentially "off" most of the time. So, don't let heat concern you here.

Finally, we come to the power supply. To simplify things, I bought an el-cheapo switching type wall wart off of Amazon for about five bucks. This provides the +12V voltage for the analog portion of the metronome. It also feeds IC3 – the common LM7805 voltage regulator – creating the +5V DC required by the PIC16F88.

Here's an important caveat: Analog ground and digital ground should connect at one point only. This is taken care of by the printed circuit board (PCB) about to be described.

## Are You Ready To Build?

Despite its potent features, the Sirius metronome is remarkably easy

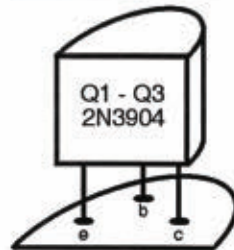
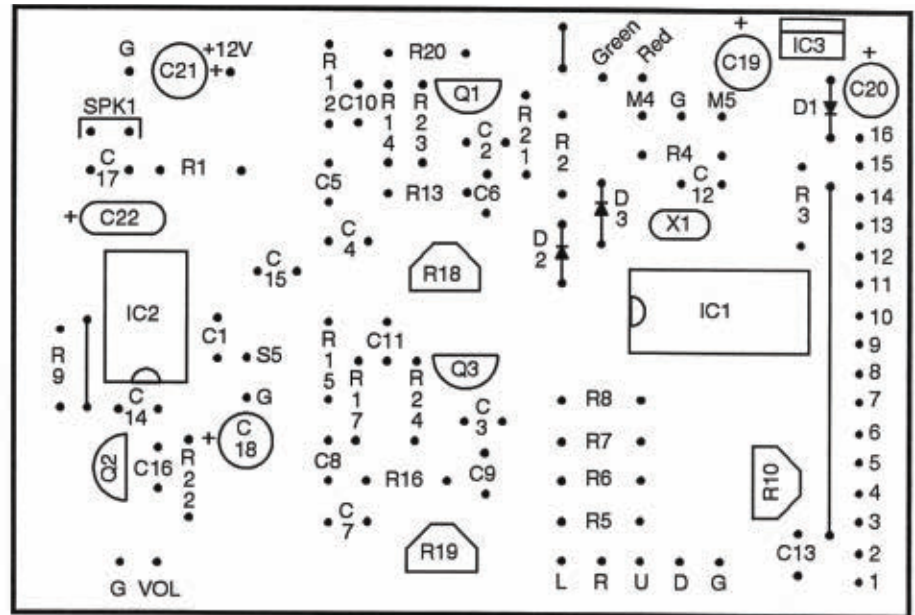

### Key to the Panel Connections

1-16:	LCD	L:	S1
VOL:	hot lug of R11	R:	S2
S5:	center lug of S5	U:	S3
SPK1:	speaker	D:	S4
+12V:	regulated +12V input	M4:	MIDI jack, pin 4
G:	ground	M5:	MIDI jack, pin 5
Green:	green LED element	Red:	red LED element

There are 3 jumpers indicated by straight lines.

■ FIGURE 4. Parts placement guide for the PCB.

to build. You could make it up on perfboard, as long as you are neat and tidy. Those Twin-T filters are very high gain, so rat's nest wiring is sure to cause headaches. A better

approach is to use a PCB.

I whipped up a circuit board in a trice, and it works very well. It's single-sided and sports fairly fat traces, making it a snap to etch at

## PARTS LIST

### ITEM DESCRIPTION

All fixed resistors are 1/4 watt, 5% values.

R1	2.7Ω
R2	180Ω
R3, R4	220Ω
R5 - R9	4.7K
R10	10K trimmer
R11	10K audio potentiometer
R12 - R17	39K
R18, R19	50K trimmer
R20, R21	220K
R22	470K
R23, R24	1M

Capacitors are 16V or better.

C1	47 pF disc
C2, C3	0.001 μF mylar
C4, C5	0.0047 μF mylar

C6 - C8	0.01 μF mylar
C9	0.022 μF mylar
C10, C11	0.047 μF mylar
C12 - C14	0.1 μF disc
C15 - C17	0.1 μF mylar
C18	4.7 μF electrolytic
C19 - C21	10 μF electrolytic
C22	220 μF electrolytic

### Semiconductors

D1	1N4004 rectifier (see text)
D2, D3	1N4148 diode
D4	Bicolor LED
Q1 - Q3	2N3904 transistor
IC1	PIC16F88
IC2	LM380 amplifier
IC3	7805 +5V regulator
X1	20 MHz ceramic resonator
LCD1	2 x 16 LCD display

### Other components

J1	1/4" OC phone jack
J2	Five-pin DIN jack
S1 - S4	SPST pushbutton switch
S5	SPDT toggle switch
SPK1	8Ω loudspeaker

Miscellaneous: +12V wall wart, circuit board, IC sockets, heatsinks, solder, wire, enclosure, etc.

The PIC16F88 is available from many supply houses, including Jameco ([www.jameco.com](http://www.jameco.com)), SparkFun Electronics ([www.sparkfun.com](http://www.sparkfun.com)), and Mouser ([www.mouser.com](http://www.mouser.com)).

All other parts are commonplace and available from general suppliers and even surplus houses.



■ **FIGURE 5.** The circuitry mounted inside a wooden box.



home. A file is provided at the article link. **Figure 4** shows the parts placement guide. I wanted a metronome that looked sort of "traditional" and decided to go with a wooden box. I found just the thing at Hobby Lobby for around \$5. After cutting the various holes (coping saw, drill, files, etc., required), I then painted the affair a dark brown. I knew ahead of time that hum and noise could be a problem due to the high gain nature of the analog circuitry, so I stuck some copper foil tape strategically around the inside of the cabinet and grounded it.

Being made of copper, I was able to solder a ground wire directly to the tape. If you use aluminum foil, however, then you'll have to screw in a solder lug instead to make electrical contact. In all

■ **FIGURE 6.** Front side of the Sirius Metronome.

honesty, I'll tell you right now that if I were doing this again, I'd go with a metal enclosure so I wouldn't have to deal with all that shielding business.

By the way, the PCB pattern provides some extra ground pads to make it easy to run shielded cable to the volume control, line output jack, and mute switch. **Figure 5** reveals the innards.

I hate wall warts with a passion, so I actually mounted this one internally. You'll notice that I glued it to the inside back with a cement called Goop (available at most hardware stores). I also used Goop — along with lots of heat shrink tubing — to make sure all 110 VAC connections were completely covered; an electrocuted performer can't make much music (except possibly on a harp).

The photograph in **Figure 6** shows what the front panel looks like. I deliberately kept it uncomplicated and somewhat Spartan in nature. The speaker, by the way, was a real find. I got it surplus from All Electronics and despite its 1-1/2 inch diameter, it has an amazingly rich sound. Inside a wooden box, it's even better.

Finally, in **Figure 7**, you'll see what the back looks like. From the top down, you'll spy the mute switch, the volume control, the line out jack, the power switch, the MIDI output jack, and the AC power cord.

## About the Code

I could tout the Sirius metronome for pages and pages; there really are some neat things going on here, both from the hardware and software aspects. The source code (available for download from the article link) has been heavily commented and documented, making its study a very practical way to learn the Great Cow Basic language as you build this unit.

If perusing the code, be sure to observe how simple the MIDI



■ **FIGURE 7.** Back side of the Sirius Metronome.

interface is thanks to the *hSerSend* command. There's a lot of action on the LCD, but again, the compiler makes this a snap.

Don't miss the *PRINT*, *CLS*, and *LOCATE* commands; these are pretty much self-explanatory. Also worthy of comment are the custom characters used (the checkboxes and the quarter note icon).

## Final Note

Yes, building the Sirius metronome is a great learning experience, but even better, it adds a serious musical weapon to your rehearsal arsenal.

Both your programming and performing chops will benefit, so have at it! **NV**

By Jim Stewart

# BUILD AN INVERTING DC-DC CONVERTER

It's often the case that you need +V and -V when all you have is +V. For example, you need +12V and -12V, but all that's available is +12V. It would be really handy to have a "black box" that would give you -V out when you put +V in, and work over a range of voltages without adjustment. In this project, we will build just such a thing. It's a voltage mirror that can supply over 100 mA without a significant drop in voltage. The circuit uses a switched inductor as described in the sidebar.

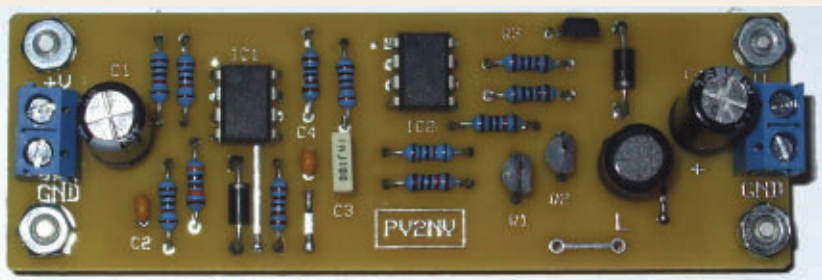

## How It Works

Figure 1 shows a block diagram of the circuit. A square wave oscillator drives a MOSFET that, in turn, drives a PNP switching transistor. The oscillator is enabled/disabled by the output of the comparator. A comparator is just an op-amp that compares a set point voltage ( $V_S$ ) to a feedback voltage ( $V_F$ ). Depending on which voltage is higher, the comparator's output goes either high (+V) or low (ground).

When  $V_{OUT}$  is the correct voltage,  $V_S$  exceeds  $V_F$  by a few micro volts and the oscillator is disabled. The PNP switch is off. When  $V_S$  is less than  $V_F$ , the oscillator is enabled and the PNP transistor switches on and off.

$V_S$  is half the input voltage ( $V_S = V_{IN}/2$ ) as set by the R-R voltage divider.  $V_F$  is set by the R-3R divider, and becomes  $V/2$  when the output voltage equals -V. The diode blocks the +V from the output while charging the inductor. It then provides a current path for the

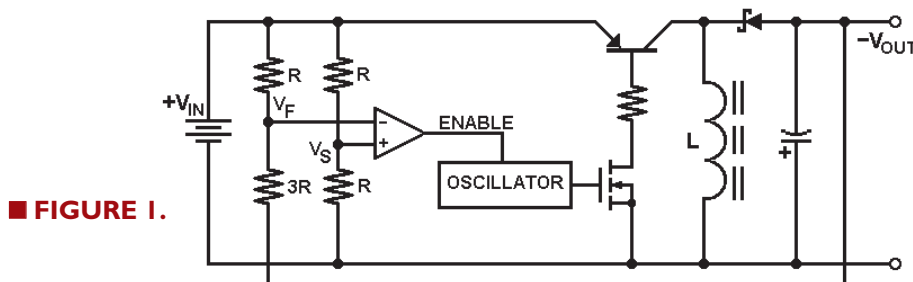

■ FIGURE 1.

discharging inductor to transfer charge to the output capacitor.

Because the diode turns on and off to control the inductor current, it's called a *commutating* diode. Commutating is an old term, often used with DC motors. It means to switch current from one path to another.

This type of circuit is often referred to as a *buck-boost* DC-to-DC converter. The term *buck* refers to the inductor opposing current through it while it charges. The term *boost* refers to the ability of the inductor to increase output voltage when it discharges. In this case, we have an *inverting* converter since a

positive input voltage produces a negative output voltage.

The oscillator causes the PNP transistor switch to open and close at a fixed frequency. When the switch closes (transistor ON), the inductor charges up. When the switch opens (transistor OFF), current from the inductor charges up the voltage on the capacitor.

The switching continues until the voltage on the capacitor becomes  $V_{OUT} = -V_{IN}$ . At that point, the comparator disables the oscillator and the PNP stays OFF. When voltage across the capacitor drops, the comparator enables the oscillator and the inductor is pumped up again.



## The Circuit

**Figure 2** shows the schematic. IC1 and IC2 are CMOS op-amps. IC1 is the comparator. IC2 forms a square wave oscillator with frequency given by  $f = 1/2.2(R7 \times C3)$ . IC2 drives Q2 through R10. IC1 controls the gate of Q1. When Q1 is off, the square wave is applied to the gate of Q2, which toggles Q3 on and off to pump up the inductor.

When Q1 is on, the gate of Q2 is grounded and Q3 stays off. Since there's a single input voltage, each op-amp uses a resistor divider to "split the rail" to create a signal ground.

That allows the negative input to see plus and minus voltages with respect to the positive input. C2 and C4 bypass the signal grounds to the supply voltage ground.

C1 and C5 are low ESR (Equivalent Series Resistance) aluminum electrolytic capacitors. Tantalum capacitors might be a bit better, but are more expensive.

ESR is a measure of how much power the capacitor will dissipate.  $P_{DISS} = I_{RC}^2 \times ESR$ , where  $I_{RC}$  is the AC "ripple current" in the capacitor. The capacitors chosen are rated for a maximum ripple current of 840 mA.

D1 and D2 are Schottky diodes. Schottky diodes can go from conducting to non-conducting very quickly, allowing a high switching frequency. They also have a low voltage drop when conducting.

In a switched inductor circuit, much of the power loss can be due to the voltage drop across the commutating diode. D1 is there in case the feedback fails and  $V_{OUT}$  becomes too negative.

Q3 is a ZTX550 PNP transistor, chosen because its specifications suit this application well:

- Maximum power dissipation:  
 $P_{MAX} = 1 \text{ watt @ } 25^\circ\text{C}$
- Maximum continuous collector current:  
 $I_C = \text{one amp}$
- Maximum collector-base voltage:  
 $V_{CBO} = 60 \text{ volts}$
- Maximum saturation voltage:  
 $V_{CE} = 0.25 \text{ volts @ } I_C = 150 \text{ mA}$
- Transition frequency:  
 $f_T = 150 \text{ MHz minimum}$
- Package:  
E-Line (slightly smaller than TO-92)

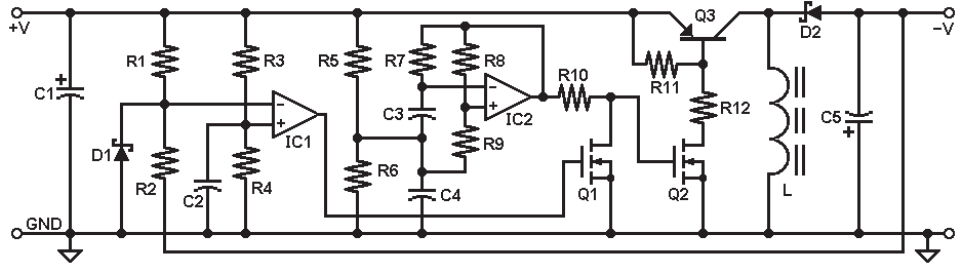

■ FIGURE 2.

## SWITCHED INDUCTORS

Like capacitors, inductors can be charged up. **Figure S1** shows a DC voltage applied to an inductor via a switch. Current ( $I_{IN}$ ) will increase according to  $I = (V/L) \times \Delta t$  where  $\Delta t$  is the length of time the inductor is charging. At maximum current ( $I_M$ ), the inductor stores energy (W) given by  $W = (L I_M^2) / 2$ . The energy is stored in the magnetic field around the inductor.

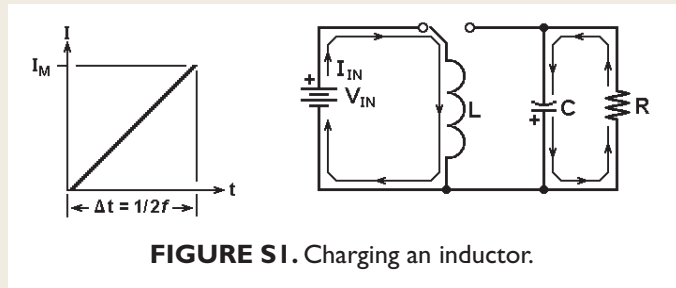

FIGURE S1. Charging an inductor.

### Current In Inductor

When the switch is moved from battery to load, the inductor discharges as shown in **Figure S2**.

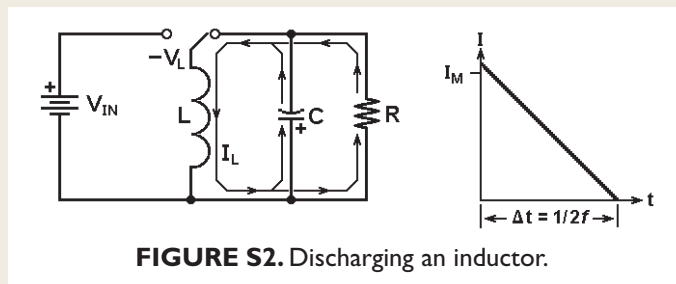

FIGURE S2. Discharging an inductor.

Four important things then happen:

First, the *magnitude* of the inductor current ( $I_L$ ) just *after* the switch is moved to the load is equal to the current ( $I_M$ ) just *before* the switch is moved. That's because energy is conserved.

Second, the *direction* of current just after the switch is moved is the same as the direction just before the switch is moved. Again, it's conservation of energy.

Third is the key point: To keep the current  $I_L$  flowing in the same direction, the voltage across the inductor will *switch polarity* as the discharging inductor acts like a generator.

Fourth, the voltage across it will become whatever value is necessary to keep the current flowing until all the energy is transferred to the capacitor or dissipated in the load resistance.

## PARAMETERS

How are  $L$ ,  $f$ , and  $R_{LOAD}$  related to each other in this circuit? We start with the requirement that the input power ( $P_{IN}$ ) be greater than the output power ( $P_{OUT}$ ). It's *greater than* instead of *equal to* because efficiency is not 100%; some power is lost. So, we need to find expressions for  $P_{IN}$  and  $P_{OUT}$ . We then let  $P_{IN} > P_{OUT}$  and see what we get. We do it for one oscillator cycle.

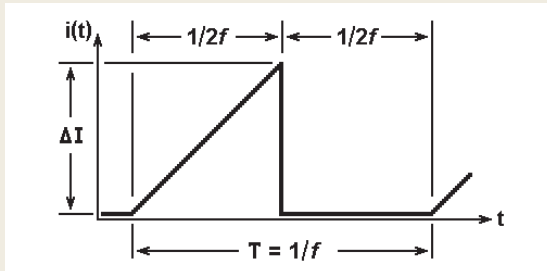

FIGURE P1.  $i$  vs.  $t$  for one cycle.

### Step 1: Find $P_{OUT}$

For the entire cycle ( $T = 1/f$ ), we have

$$\text{Equation 1: } P_{OUT} = V_{OUT}^2 / R_{LOAD}$$

### Step 2: Find $P_{IN}$

$P_{IN} = V_{IN} \times I_{IN}$  where  $I_{IN} = I_{DC} =$  average current ( $I_{AVG}$ ) during the entire cycle

For the first half-cycle,  $I_{AVG} = \Delta I / 2$  while for second half-cycle  $I_{AVG} = 0$

So, for the entire cycle  $I_{AVG} = (\Delta I / 2 + 0) \div 2 = \Delta I / 4$

In a charging inductor,  $V = L \times (\Delta I / \Delta t)$ , so  $\Delta I = (V_{IN} / L) \times \Delta t$

The inductor charges during  $\Delta t = T / 2 = 1 / 2f$

So,  $\Delta I = V_{IN} / 2fL$

And for the entire cycle  $I_{AVG} = \Delta I / 4 = V_{IN} / 8fL$

So,  $P_{IN} = V_{IN} \times I_{AVG} = V_{IN} \times (V_{IN} / 8fL)$  to give

$$\text{Equation 2: } P_{IN} = V_{IN}^2 / 8fL$$

### Step 3: Let $P_{IN} > P_{OUT}$ and solve

$P_{IN} > P_{OUT}$  gives  $V_{IN}^2 / 8fL > V_{OUT}^2 / R_{LOAD}$

Invert both sides to get  $1/P_{IN} < 1/P_{OUT}$

So,  $8fL / V_{IN}^2 < R_{LOAD} / V_{OUT}^2$

Re-arrange terms to get  $8fL < (V_{IN} / V_{OUT})^2 \times R_{LOAD}$  which gives

$$\text{Equation 3: } fL < (V_{IN} / V_{OUT})^2 \times (R_{LOAD} / 8)$$

And if,  $V_{OUT} = V_{IN}$  we get

$$\text{Equation 4: } fL < R_{LOAD} / 8$$

## Design Parameters

This design has five important parameters:

- Input voltage:  $V_{IN}$
- Output voltage:  $V_{OUT}$
- Load resistance:  $R_{LOAD}$
- Oscillation frequency:  $f$
- Inductance value:  $L$

The parameters are related to each other by the equation:

$$fL < (V_{IN} / V_{OUT})^2 \times (R_{LOAD} / 8)$$

(To see where the equation comes from, see the **sidebar**.)

We want the magnitudes of  $V_{IN}$  and  $V_{OUT}$  to be equal, so the equation becomes:

$$fL < (R_{LOAD} / 8)$$

For our circuit,  $L = 220 \text{ mH}$ ,  $f = 45 \text{ kHz}$ , and  $R_{LOAD} = 100 \Omega$ . To see if those values work, we need to verify that  $fL$  is less than  $R_{LOAD} / 8$ .

$$fL = (45 \times 10^3) \times (220 \times 10^{-6}) = 9900 \times 10^{-3} = 9.9 \Omega$$

$$R_{LOAD} / 8 = 100 / 8 = 12.5 \Omega$$

Since 9.9 is less than 12.5, the circuit should work. Note that increasing the load resistor makes  $fL$  even less than  $R_{LOAD} / 8$ .

**Note:** The above calculation just lets us verify that the values we use are in the ballpark. It's not an exact description.

I replaced the 220  $\mu\text{H}$  inductor with one that was 330  $\mu\text{H}$  and it worked just fine. Also, the value of an inductor usually drops as the DC current through it increases.

# Performance

**1. Mirror Effect:** A 1 kΩ load was connected to the output and V<sub>OUT</sub> was measured for various values of V<sub>IN</sub>. The results are shown in **Table 1**. Note that the differences are more or less constant. That means the circuit has a fixed offset of about 0.11 volts. That could be “zeroed out” by adjusting R1 or R2.

**2. Efficiency (η):** V<sub>IN</sub> was set to +12V and a 110 Ω load was connected to the output. Input current was measured to obtain input power P<sub>IN</sub> = V<sub>IN</sub> × I<sub>IN</sub>. Output power was V<sub>OUT</sub> / 110 Ω. The result was:

$$I_{IN} = 150 \text{ mA}$$

$$P_{IN} = 12\text{V} \times 150 \text{ mA} = 1.80 \text{ watts}$$

$$P_{OUT} = (11.86 \text{ V})^2 / 110 \Omega = 1.28 \text{ watts}$$

$$\eta = (P_{OUT} / P_{IN}) \times 100\% = (1.28\text{W} / 1.80\text{W}) \times 100\% = 71.1\% \text{ efficiency}$$

**3. Load Regulation:** With 12 volts in, V<sub>OUT</sub> was 11.87 volts with a 1 kΩ load and 11.86 volts with a 110 Ω load. That gives a load regulation of:

$$\text{LOAD-REG} = [ (11.87 - 11.86) / 11.87 ] \times 100\% = 0.08\%$$

A load regulation of 0.08% is not bad for such a simple circuit.

**4. Ripple Voltage:** With V<sub>IN</sub> = 12 volts and a 110 Ω load on the output, ripple voltage was 50 mV<sub>pp</sub> as measured with an oscilloscope.

V <sub>IN</sub>	V <sub>OUT</sub>	Difference
6.0V	- 5.90V	0.10V
7.0V	- 6.89V	0.11V
8.0V	- 7.89V	0.11V
9.0V	- 8.89V	0.11V
10.0V	- 9.88V	0.12V
12.0V	- 11.87V	0.13V
12.0V	- 11.86V across 110 Ω	0.14V
15.0V	- 14.86V	0.14V

**Table 1: V<sub>OUT</sub> vs. V<sub>IN</sub>**

# Construction

The printed circuit board (PV2NV) component layout is shown in **Figure 3**. The optional terminal blocks are not shown. The solder side is shown in **Figure 4**. An ExpressPCB file (PV2NV.PCB) is available at the article link.

There is a mounting hole at each corner of the board that's big enough for a #4 screw. The mounting hole with the square outline is connected to circuit ground by a thin strip of copper, so mounting the board to a metal chassis will connect ground to the chassis. If that's not desirable, you can cut the strip.

Board dimensions are 3.8 inches by 1.25 inches.

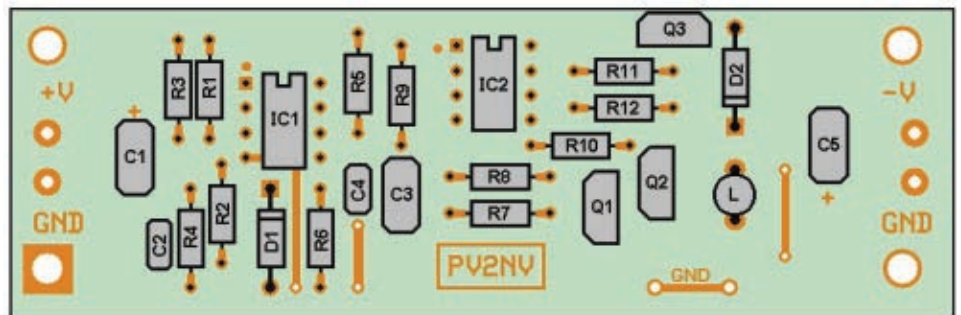

**FIGURE 3.**

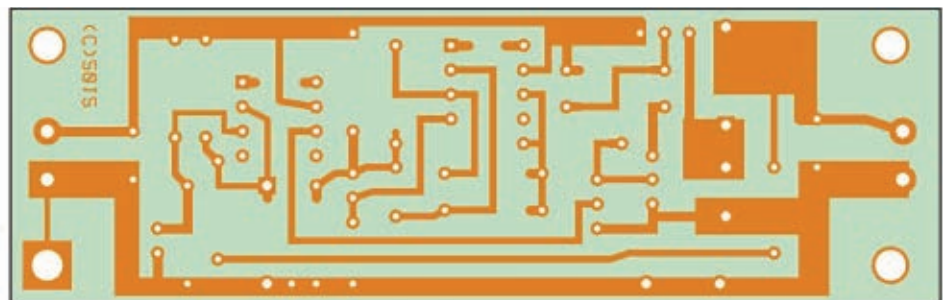

**FIGURE 4.**

A set of parts is available from the *Nuts & Volts* Webstore at <http://store.nutsvolts.com>.

## Procedure

If you have a lead forming tool (**Figure 5**), bend the resistor and diode leads to a 0.4 inch spacing. Such tools (Electronix Express part #0664ST010; Jameco part #106884) are inexpensive and handy to have. (When inserting components into the board, bend the leads slightly on the solder side to secure them in place.)



■ **FIGURE 5.**

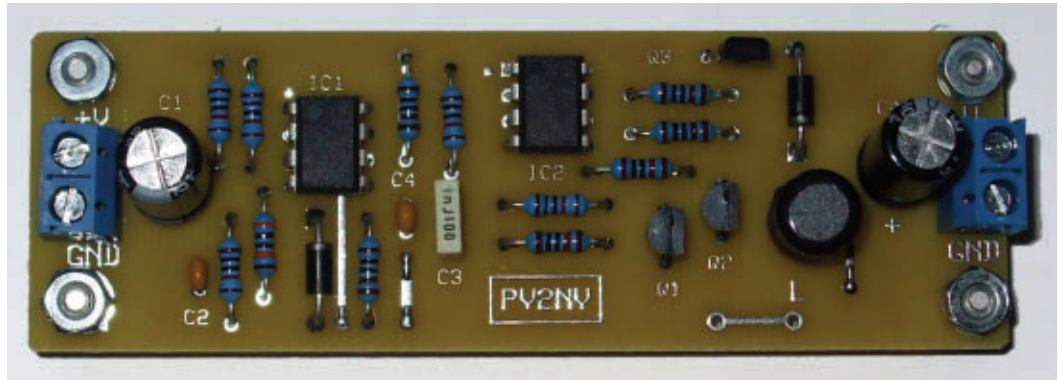

■ **FIGURE 6.**

Here is a suggested sequence for mounting the components:

- Insert R3, R1, R5, R9, and solder. Clip off excess leads.
- Insert R4, R2, R6, and solder. Clip off excess leads.
- Insert R11, R12, R10, R8, R7, and solder. Clip off excess leads.

- Insert D1, D2, Q1, Q2, Q3, and solder. Clip off excess leads.
- Insert IC1 then IC2. Verify pin 1 is in the proper hole and then solder.
- Insert the inductor and capacitors. Note polarity of C1 and C5. Solder and clip off excess leads.
- If using terminal blocks (optional), mount and solder them.
- Clean off the solder side with

some rubbing alcohol and a scrub brush. Give the assembled board a good visual inspection and fix any problems you find.

Assembly is now complete. A photograph of the assembled board is shown in **Figure 6**.

## Testing

Now for the moment of truth: Apply  $V_{IN}$  and measure  $-V_{OUT}$  with your multimeter. Verify that the magnitudes of  $V_{IN}$  and  $V_{OUT}$  are equal. If not, remove power and examine the board. Check for the usual suspects:

- Any solder bridges or bad solder joints?
- Are components in the right place?
- Are any components missing?
- Are the cathode and anode of a diode swapped?
- Are the transistors in backwards?
- Are the polarities of the electrolytic caps reversed?
- Do the ICs have pin 1 in the correct hole?



**SERVO**  
MAGAZINE  
2012 CD-ROM  
Order yours today!

For personal use only. Copyright 2012-2013 T & L Publications, Inc. All rights reserved. May NOT be posted on a public or corporate internet site.

**SERVO**  
MAGAZINE  
2012  
Volume 10, Nos. 1-12

**Only \$24.95**  
**Free Shipping!**

[www.servomagazine.com](http://www.servomagazine.com)

## PARTS LIST

ITEM	DESCRIPTION
R1:	100 k $\Omega$ , 1/4W, 1%
R2:	301 k $\Omega$ , 1/4W, 1%
R3:	100 k $\Omega$ , 1/4W, 1%
R4:	100 k $\Omega$ , 1/4W, 1%
R5:	1 k $\Omega$ , 1/4W, 1%
R6:	1 k $\Omega$ , 1/4W, 1%
R7:	10 k $\Omega$ , 1/4W, 1%
R8:	100 k $\Omega$ , 1/4W, 1%
R9:	100 k $\Omega$ , 1/4W, 1%
R10:	10 k $\Omega$ , 1/4W, 1%
R11:	1 k $\Omega$ , 1/4W, 1%
R12:	1 k $\Omega$ , 1/4W, 1%
L:	220 $\mu$ H Digi-Key part #811-1316-ND or equivalent
C1:	220 $\mu$ F, 35V Digi-Key part #493-1578-ND or equivalent
C2:	0.1 $\mu$ F, 50V, ceramic
C3:	1 nF film, 5% Digi-Key part #399-5871-ND or equivalent
C4:	0.1 $\mu$ F, 50V, ceramic
C5:	220 $\mu$ F, 35V Digi-Key part #493-1578-ND or equivalent
Q1:	2N7000
Q2:	2N7000
Q3:	ZTX550 PNP
D1:	Schottky, one amp, 1N5819 or equivalent
D2:	Schottky, one amp, 1N5819 or equivalent
IC1:	CA3140
IC2:	CA3140

Printed Circuit Board: An ExpressPCB file called PV2INV.PCB is available for download from the article link.

Terminal Blocks (optional): Two-position, 5 mm spacing, Jameco part #2094485 or equivalent.

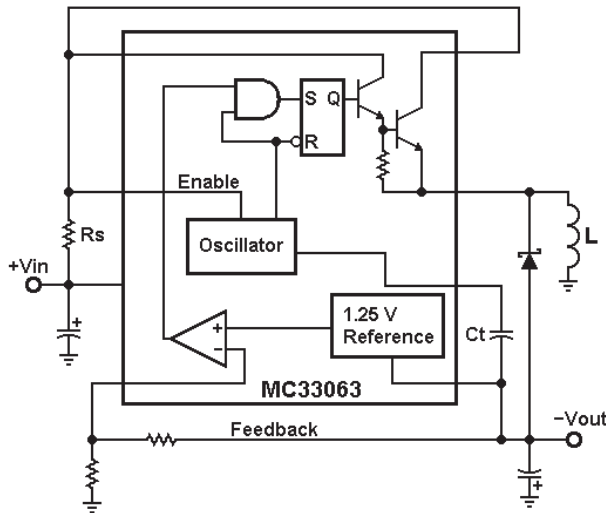

■ FIGURE 7.

## Wrapping Up

Most buck-boost converters use pulse width modulation (PWM) to control the voltage applied to the inductor. Feedback voltage is compared to a fixed reference voltage and the pulse width is adjusted to obtain the desired output voltage. An example circuit using the MC33063 IC is shown in **Figure 7**.

Note that the output voltage of such a circuit depends only on the reference and does not change with the input voltage. For our circuit, output voltage is a mirror image of input voltage. Since I've never seen a similar circuit, I'm tempted to think there aren't any like it. That, however, is not very likely. **NV**

Need a small and cost-effective device?  
Look no further.



### PoScope Mega1+

Smallest USB 2.0 portable 1MS/s oscilloscope  
Data acquisition of analog and digital signals  
Data recording  
Export to CSV, XLS, PDF and HTML  
Simple usage of advanced features  
Examples for C++, VB, Delphi and LabView  
Free software and updates



### PoKeys 56

Smallest USB HID or ETHERNET I/O interface  
Keyboard and joystick simulator (USB)  
55 digital I/O (configurable)  
LCD and LED matrixes driver  
6 PWM outputs, 26 encoder inputs  
Supports up to 10 I2C, 1-Wire sensors,  
up to 7 analog sensors  
Expandable with PoNet  
Free software and web interface (Ethernet)

Visit [www.poscope.com](http://www.poscope.com)

**PoLabs**





# KING TUT'S PYRAMID GRAVIMETER

By Ron Newton

**Gravity is that mysterious force that most of us fight when we step on the scales. Actually, it is not our weight we need to worry about, but our mass. If it wasn't for Isaac Newton, we would all be floating around space as he discovered gravity. Some people believe that the pyramids were built by aliens using an anti-gravity technique. So, the weight for this project is in the shape of a pyramid. Its name may be a little tongue in cheek, however, this is a very serious working instrument.**

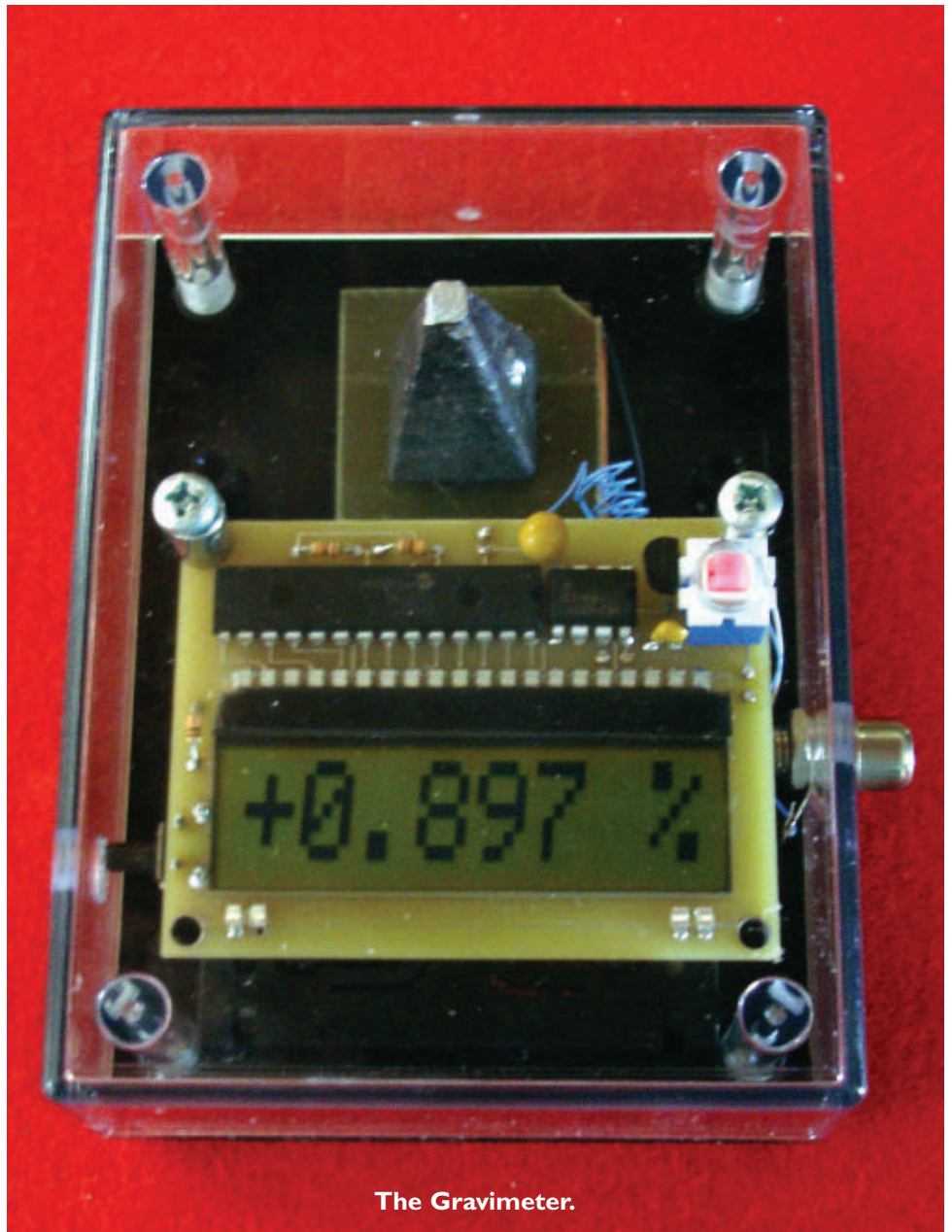

**The Gravimeter.**

This project can be built for about \$30 and is easy to construct because it has no surface-mount components. It uses an inexpensive LCD display that does graphics and alpha numeric characters which are all driven by 11 inputs.



## Electronics

The sensor is a variable resistor comprised of electro-conductive foam. It changes resistances when squeezed together. It has a resistance of approximately 1,000 ohms when constructed. The PIC uses a process for calculating the time it takes the resistor to charge a capacitor.

The formula for charging a capacitor is  $R * C = t$ .

R is in ohms and C is in farads; "t" is in seconds.

$$1,000 * 100 \mu F = .1 \text{ seconds}$$

The TMR0 register is used as it advances one count every .000, 001

of a second. When it rolls over to 255, it causes an interrupt and increments two more registers until the voltage exceeds a preset amount in the comparator, so 1,000,000 per second x .1 seconds = 100,000 counts. Since gravity can vary  $\pm 2\%$ , the count can vary by 2,000 counts.

There are a number of algorithms built into the software which perform addition, subtraction, multiplication, and division.

Once a base count is established, the difference in counts between the base count and the new

count is determined. This difference is then divided by the base count times 100. This will give a percent change of the gravity field. (Refer to **Equation 1.**)

The microprocessor used has memory areas to store previous data. When pressing the zero switch, this "zeros" the base count number and stores it in the EEPROM area. Pushing the zero button while pressing the on/off switch will load the base count. If it's not pushed, it will calculate a new base count after averaging 25 counts.

**Equation 1.** 
$$\frac{\text{Difference between new count and base count}}{\text{Base count}} * 100 = \% \text{ change of gravity}$$

## The Detector

Cut two 1.25" square single-sided copper boards. Solder two 4" wire-wrap wires to each plate. Cut the wire off of the bottom of the 2 oz pyramid sinker; sand flush and glue it to the top pad on the non-conductive side.

**Do not use** steel weights because they are subject to magnetic fields.

Using double-sided tape, press the other copper board face up to the bottom of the chassis center, about 1/8" from the side opposite the battery compartment. The wire should be facing the battery compartment.

Cut a 1" square of conductive 1/4" foam (the stuff that electronic parts are often shipped in). Put a small drop of graphite-filled conductive wire glue (RadioShack #64-146) on the bottom corners (1 and 3) of the conductive foam and place this on the bottom copper board.

Add a drop of glue on corners 2 and 4 on the top side of the foam, and center the other board. Allow this to dry overnight.

Do not use too much glue as it will flow through the foam and short it out. You must use conductive glue. Treat the sensor gently because the foam can tear from the boards. The sinker will help hold the sensor while it sets.

After it's dry — using an ohmmeter — check the resistance of the two plates; it should be around 500 to 1,000 ohms.





## Component Specifics

The unit is powered by a nine volt battery. IC3 is an LM7805 five volt voltage regulator. The circuit draws 3.5 mA, and the battery should last about six days.

C1 smoothes out any ripples. If you are going to leave it on all the time, use a nine volt battery eliminator.

The PIC shorts out the charging capacitor C2 and then voltage is applied across the sensor. The capacitor will charge and when its voltage reaches a preset value of the

comparator, it signals the microprocessor to calculate the number of counts the TRM0 register has made during this charging period.

The math functions take over from there. The display shows up to three decimal places. The DAC is a 12-bit digital-to-analog converter. Its voltage is centered at 2.5 volts for a zero position on chart recorders. The  $\pm$  percent change is added or subtracted from 2.5 volts.

This gives a very sensitive graph. My first recording went off the chart, so I reduced the chart reading by two ( $\therefore \pm$  one volt from 2.5 volts = 2% gravity change).

## The Chassis

The first thing to do is put the box together with screws as they have to form threads. This will make it easier to assemble when you put everything together.

Download the chassis templates from the article link. Cut the template and glue it on the top of the box. Drill the five holes as called for on the drawing. The templates can be removed by hot water.

Place the jack from the left outside of the box and secure it with its nut.

## Gravigram

I have several chart recorders that I've used throughout the years. They use reams of expensive paper, so I have replaced them with my old computers, and data acquisition units with software.

Dataq ([www.dataq.com](http://www.dataq.com)) makes a data acquisition module which sells for under \$30 and measures four analog signals, along with two digital inputs. This is a must for any mad scientist's laboratory.

I have been using several of their products for 20 years or more. You just connect the module to your computer and it charts your data. With their free software, you can compress a month of data into one page for printing.

The DAC produces 0-5 volts. Connect the data acquisition unit by using an RCA plug. Plug it into your computer and call up the software. There are a plethora of commands; just refer to the software manual. It will monitor a live display of the voltages, and it will sample up to 240 Hz, giving you a magnetogram.

I have used these types of modules for seismograph recording, gathering a month's worth of data at a time. You can save the data and call it back to look at individual periods of one minute.

If you don't want to tie up a computer, have this for field use, or be a stand-alone, Dataq makes voltage monitors that

plug into a USB port and chart the results. The EL-USB-3 USB data logger sells for \$75. It will sample from one second for nine hours, or every minute for 22 days. For other applications, it will sample 12 hours for approximately two years.

Start the EL-USB-3 USB data software and set its parameters. You can use an immediate start or a delay start. It even has alarm LEDs. Connect it to the red and white wires, noting the polarity. You can remove it at anytime and download its data using the USB port; it will chart your data for you.

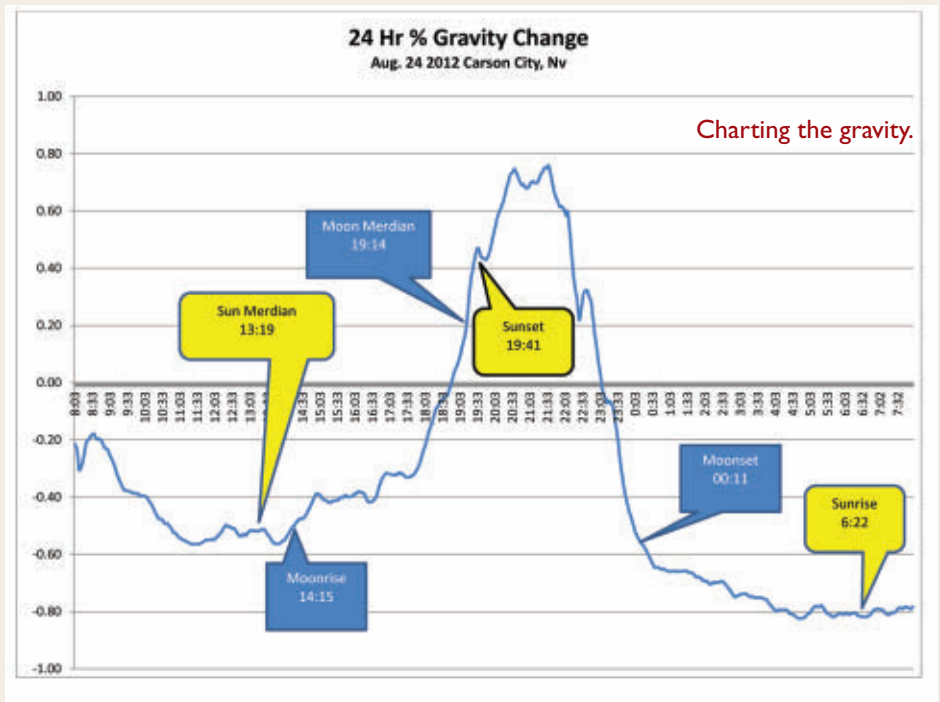

## The Circuit Board

The circuit board files are generated using ExpressPCB and are also at the article link, along with Hints and Tips, a source list, and ASM files. (The boards are also available in the *Nuts & Volts* webstore, along with kits and preprogrammed microprocessors.)

Use a 6-32 tap and tap the two corner holes.

Solder R1, R2, R3, and C1. Note the polarity of C2 and solder the positive terminal to the square pad. Solder IC1 and IC2, noting pin 1 goes to the square pads. Solder IC3 with its flat side pointing towards the edge of the switch. Solder in opto 1. Solder the on/off switch. Turn over the board and solder the momentary switch to the bottom side. (If you purchase a preprogrammed chip, skip the next paragraph.)

The chip can be programmed using the five program pads under the LCD. Use a PIC 2 or PIC 3 programmer. The assembly file is at the article link.

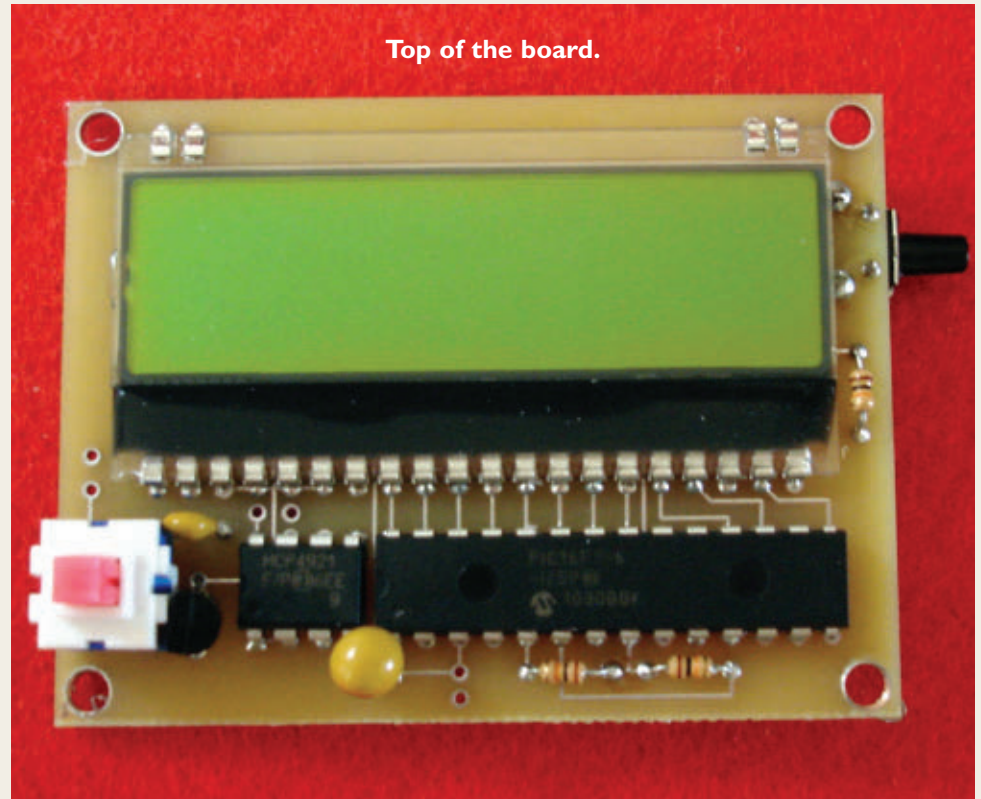

Top of the board.

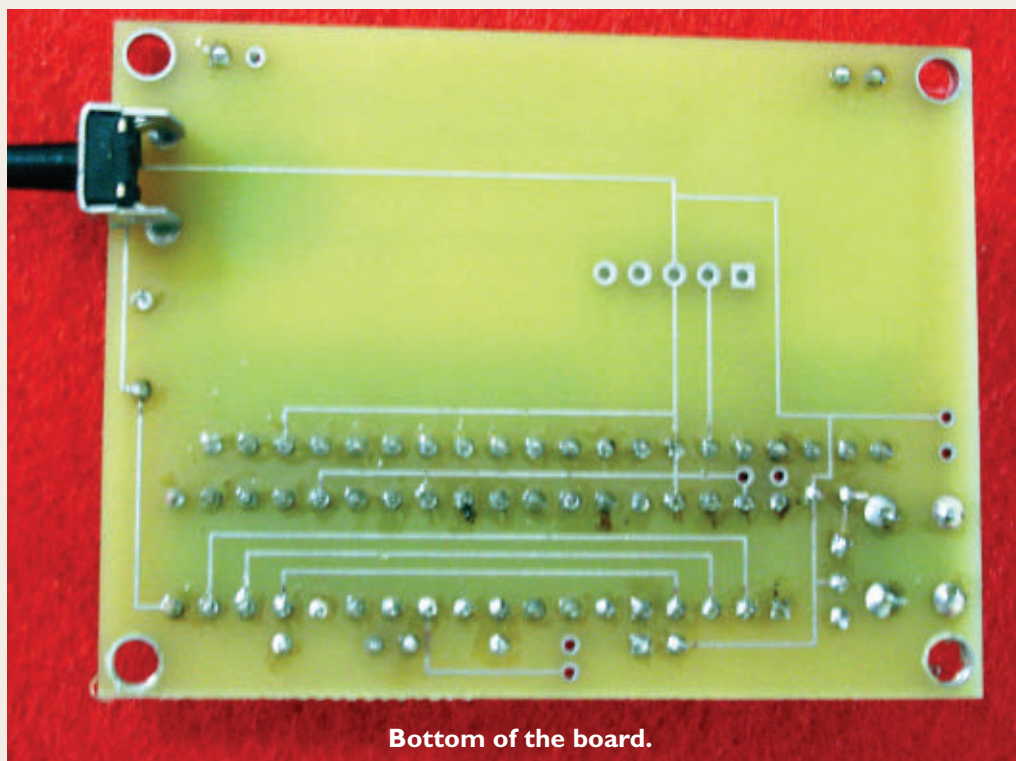

Bottom of the board.

Use two different 4" colored wire-wrap wires to the pads next to pin 7 and pin 8 of the DAC. The wire from pin 8 goes to the center post of the RCA jack, and pin 7 goes to ground. Pass the two wires from the nine volt

battery holder through a hole in the battery compartment, then through the strain hole. Solder the red wire to the + terminal and black to the - pad. Solder the two wires coming from the detector to the "in" pads. They have no polarity.

Place two 1" 6-32 screws in the two holes from the top side of the chassis. Turn it over and add the 3/8" standoff to the screw opposite the switch. Screw the board to the top of the chassis. The tapped holes will act as nuts. When finished, add a drop of finger nail polish to the ends of the screws to prevent them from turning.

Complete kits are available from the Nuts & Volts Webstore at <http://store.nutsvolts.com>.

## Using the Unit

Add a nine volt battery. If using data logging software, plug the data acquisition module into the jack.

Place the unit on a flat, level surface and push the on switch. The unit will display "LOADING." Push the zero button; the display should change and display "STANDBY."

After about 30 seconds, the display will change to "STORING" and then display the percentage. You can zero the instrument any time by pushing the zero button on the side. It will store the base

## PARTS LIST

ITEM	QTY	DESCRIPTION	PART #	SOURCE
C1	1	.1 $\mu$ F 50 volt		
BH	1	Heavy duty 9V snap connector		
Box	1	4.38 x 3.25 x 2.00 9V (black)	SR232-CB	Serpac
IC1	1	Microprocessor	Pic 16F916-I/SP	Microchip
IC2	1	DAC 12-bit	MCP4921-E/P	Microchip
IC3	1	Five volt regulator 7805		
J1	1	RCA phone jack		
Opto 1	1	LCD display	EADOGM081LA	Electronic Assembly
R1-R3	3	10K 1/6 watt		
S1	1	Switch push DPST	PVA1 EE H1	C&K
S2	1	Momentary SPST rt angle	EVQ-PF0008K	Panasonic
<b>HARDWARE</b>				
Conductive foam	1	1/4" x 1" x 1"		
Conductive glue			#64-146	RadioShack
Lead weight	1	2 oz sinker pyramid		
Screw	2	6-32 1"		
Standoff	1	#6 3/8"		
Wire-wrap wire		Two colors		
Nine volt battery				

readings in the EEPROM.

Keep in mind that the unit will be subject to temperature change and probably barometric pressure due to the foam bubbles. (It also makes a

good seismic detector.)

Always remember, to determine the gravity of any situation, you must weigh all the facts. **NV**



## Intelligent Display Modules

4D Systems designs and manufactures intelligent and cost effective display modules. Our intelligent display modules offer a simple yet effective interface to any host processor, and our comprehensive workshop software suite is suitable for almost any level of developer.

**Browse Products and More Details at**

- ★ Easy to Program
- ★ Application Ready in Minutes
- ★ Plug & Play Experience
- ★ Free Software Tools and Support

**[www.4dsystems.com.au](http://www.4dsystems.com.au)**

## I'M IN AN LMX-ISM-242 STATE OF MIND

In the previous installment of Design Cycle, we did some serious bug squashing. In the midst of the carnage, we managed to put together some BASIC I/O routines that would be needed when the hardware was ripe. While you were gone, I managed to get my hands on the official Lemos hardware. Now that we have some silicon and fiberglass that can harness the electrons we'll be pushing around with our firmware, the next logical steps are to finish the data radio drivers and write a sensor-based data radio application.

### IT'S OFFICIAL

The new line of Lemos data radios are officially identified as affordable RF modules. There are two variants: an SR (short range) model and an LR (long range) module. The SR variant answers to LMX-ISM-242-SR (LMX-SR for short) and is shown standing on its pads in **Photo 1**.

The LMX-SR logically and electrically attaches to a host microcontroller via its four-wire SPI portal. The LMX-SR comes alive when a power source between 1.9 and 3.6 volts is applied to its power pins. The maximum current consumed by it is 23 mA, which means the LMX-SR is a perfect fit for battery-powered applications.

Although its power consumption figures are impressive, I'm more interested in the data handling features of this data radio. The LMX-SR can participate in a six-node star network. Data packet handling is automatic if we choose to let the LMX-SR drive. A data packet can be stuffed with a maximum of 32 bytes. The LMX-SR is also capable of packetizing a single byte.

### AN LMX-ISM-242-SR STATE OF MIND

The LMX-SR cannot do its job until we do ours. Its transmit tasks include packetizing, transmitting, and re-transmitting data packets. The re-transmission of packets is dependent

on whether or not the auto-acknowledge mechanism is active. For our purposes, the LMX-SR's auto-acknowledge feature will be activated.

The advantage of enabling auto-acknowledge is that the LMX-SR controls its own destiny by way of its internal state machine. We can easily override the auto-acknowledge function using one of the LMX-SR's special transmit commands and still take advantage of the functionality of its state machine. With auto-acknowledge disabled, we must code every aspect of the transmit and receive processes. There's no need to do that. So, we won't.

Receiving requires a bit more work. In receive mode, the LMX-SR must sense a carrier, sync up with the incoming preamble, receive, buffer, and CRC (cyclic redundancy check) the incoming raw data, check the packet's destination address, and extract the payload data.

There are six 32-byte receive pipes (buffers) which allow up to six messages to be in the receive queue at the same time. If instructed to do so, the receiving LMX-SR will also acknowledge the received packet. Auto-acknowledge plays the same part in receive mode as it does in transmit mode.

With the LMX-SR state machine in charge, we only need to manipulate the LMX-SR's pair of internal register banks to wirelessly transmit and receive. To enter

■ **PHOTO 1.** Lots of radio is stuffed in the LMX-ISM-242-SR's 16.8 x 12.8 x 1.0 mm package. Data packets are transferred to the host microcontroller over a four-wire SPI portal. At maximum transmit power, the LMX-SR draws 23 mA.

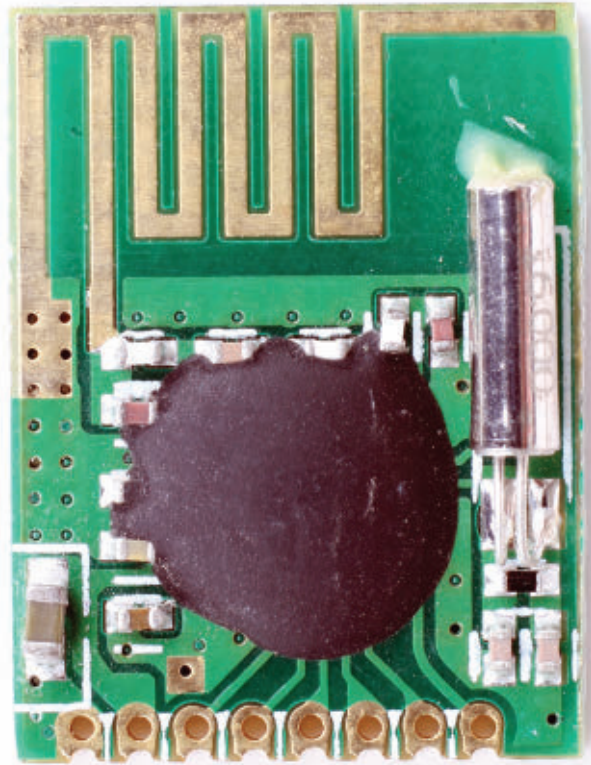

transmit state at power-up, we must set the *PWR\_UP* bit. Setting this bit moves the LMX-SR's state machine into *Standby-I* which is the lowest power consuming active state. The *PWR\_UP* bit is set in the initialization code. However, we can set and clear the *PWR\_UP* bit at any time.

The LMX-SR's SPI portal is active in *Standby-I* and we can clear the *PRIM\_RX* bit at this time, which readies us for transmit operation. The *PRIM\_RX* bit is cleared in this manner with the *txMode* function:

```
void txMode()
{
    BYTE data;

    //LMX-ISM-242-LR
    bit_set(rTREN);
    bit_set(rPAEN);
    delay_ms(50);

    spi_wrt_cmd(FLUSH_TX,0);
    //read CONFIG register
    bit_clear(rCE);
    data=spi_rd_reg(CONFIG);
    //clear PRIM_RX bit
    data &= 0xFE;
    spi_wrt_reg(CONFIG, data);
    bit_set(rCE);
}
```

The LMX-ISM-242-LR (LMX-LR for short) code you see in the *txMode* function controls the power amplifier transmit and receive states. The LMX-LR is a high-power version of the LMX-SR. The LMX-LR and LMX-SR are pinned out identically with the LMX-LR sporting the extra TREN (Transmit Enable) and PAEN (Power Amplifier Enable) pins.

Once everything is good with the auto-acknowledge status, we clear the LMX-SR's *CE* (Chip Enable) bit and twiddle the *PRIM\_RX* bit to a logical low. With the *CE* bit held logically high, we only need to place a byte in the *TX FIFO* (First In, First Out) to kick off a transmission. Loading a byte into the *TX FIFO* sends the byte and forces the state machine into *Standby-II*. When the next byte is loaded into the *TX FIFO*, it is sent and the state machine returns to *Standby-II*. This process repeats until the *CE* bit is cleared, which returns the state machine to *Standby-I*.

If an acknowledgement is expected, the *CE* bit would be pulsed low-high-low after the *TX FIFO* is loaded. The byte is transmitted and the LMX-SR's state machine falls into receive mode and awaits the acknowledgement. If the acknowledgement is received before its timeout, the state machine pushes into *Standby-I* and awaits another *CE* pulse.

Entering receive mode is very similar to entering transmit mode. The only real difference for the LMX-SR is a logical OR instead of a logical AND operation against the *CONFIG* register:

```
void rxMode()
{
    BYTE data;

    //LMX-ISM-242-LR
    bit_clear(rTREN);
    bit_set(rPAEN);
    delay_ms(50);

    spi_wrt_cmd(FLUSH_RX,0);
    //read CONFIG register
    data = spi_rd_reg(STATUS);
    spi_wrt_reg(STATUS,data);

    bit_clear(rCE);
    data = spi_rd_reg(CONFIG);
    // read register CONFIG's value

    //set PRIM_RX bit
    data |= 0x01;
    spi_wrt_reg(CONFIG, data);
    bit_set(rCE);
}
```

Note the states of the LMX-LR's TREN and PAEN inputs for receive mode. Setting the *CE* bit with the *PRIM\_RX* bit cleared forces the LMX-SR's state machine from *Standby-I* mode to receive mode. As long as the *CE* bit is logically high, the LMX-SR looks for a preamble, demodulates the incoming data signal, looks for a valid address and CRC, and places the incoming data packet

into the appropriate pipe. If an acknowledgement is required, the state machine will switch to transmit mode and return to receive mode once the acknowledgement is transmitted.

## CONFIGURING THE LMX-ISM-242-SR

You've gotten a taste of how to manipulate the bits in the LMX-SR's *CONFIG* register. So, let's take a closer look at the registers and their configuration bits.

The LMX-SR register set consists of two banks of configuration registers. Most all of the post initialization work is done in Register Bank 0. Register Bank 1 is primarily a write-only register bank that is populated in the *initialize* routine. The Chip ID and register bank selection (0 or 1) are the only readable registers in Register Bank 1.

All of the Register Bank 1 registers are 32 bits in length with the exception of the *RAMP* register which is 88 bits long. Most of these registers are loaded with predefined values that are laid out in the LMX-SR datasheet. However, you can do things like select the receive sensitivity, enable the RSSI (Received Signal Strength Indicator), and set the RSSI threshold. The Register Bank 1 data we will use in this discussion looks like this:

```

//*****
/** BANK1 REGISTER INITIALIZATION VALUES
//*****
unsigned int32 const Bank1_Reg0_13[]={
0xE2014B40, //0 Send LSB First
0x00004BC0, //1 Send LSB First
0x028CFC0, //2 Send LSB First
0x41390099, //3 Send LSB First
0x1B8296D9, //4 Send LSB First
0xA67F0224, //5 Send LSB First
0x00000000, //6 Send LSB First
0x00000000, //7 Send LSB First
0x00000000, //8 Send LSB First
0x00000000, //9 Send MSB First
0x00000000, //10 Send MSB First
0x00000000, //11 Send MSB First
0x00127300, //12 Send MSB First
0x46B48000, //13 Send MSB First
};

BYTE const Bank1_Reg14[]={0x41,0x20,0x08,0x04,
0x81,0x20,0xCF,0xF7,0xFE,0xFF,0xFF};

```

Note that some of the Register Bank 1 values must be sent LSB (Least Significant Byte) first, while others are sent MSB (Most Significant Byte) first. The byte reversal process is outlined in the *init* function of the LMX-SR driver source code.

Basically, the individual bytes are masked and copied into a buffer in the order we wish to send them. The 11 bytes that are to be written to Register Bank 1 register 14 are populated in the correct order in the Flash-resident array *Bank1\_Reg14*. Once we place the reordered bytes into the buffer, the *spi\_wrt\_buf* function is used to transfer the values to the registers that make up the LMX-SR's Register Bank 1:

```

//*****
/** SPI WRITE BUFFER
//*****
void spi_wrt_buf(BYTE reg, BYTE *buf, BYTE len)
{
    BYTE i;
    reg |= WRITE_REG;
    bit_clear(rCSN);
    SSP1BUF = reg;
    while(!bit_test(BF));
    wr_status = SSP1BUF;
    for(i=0; i<len; i++)
    {
        SSP1BUF = buf[i];
        while(!bit_test(BF));
        wr_status = SSP1BUF;
    }
    bit_set(rCSN);
}

```

The SPI code in the *spi\_wrt\_buf* function should look familiar. The byte that is sent initially is a combination of the register address and the *WRITE\_REG* command. And, yes. The LMX-SR driver also includes a Read Buffer function:

```

//*****
/** SPI READ BUFFER
//*****
void spi_rd_buf(BYTE reg, BYTE *buf, BYTE len)
{
    BYTE i;

    bit_clear(rCSN);
    SSP1BUF = reg;
    while(!bit_test(BF));
    wr_status = SSP1BUF;
    for(i=0; i<len; i++)
    {
        SSP1BUF = 0x00;
        while(!bit_test(BF));
        buf[i] = SSP1BUF;
    }
    bit_set(rCSN);
}

```

The Read Buffer function operates just like you think it does. This function is used to read multi-byte resources such as the LMX-SR's *RX FIFO* and the Register Bank 0 transmit/receive address registers.

We've already seen the SPI register read and write routines in action. The byte-wide data communicated by the aforementioned functions is arranged in the LMX-SR driver code like this:

```

//*****
/** BANK0 REGISTER INITIALIZATION VALUES
//*****
BYTE const Bank0_Reg[][2]={
{0,0x0F}, //RX_DR\TX_DS\MAX_RT = active low
//IRQ,Enable 2-byte CRC,POWER
//UP,receive mode
{1,0x3F}, //Enable auto acknowledgement data
//pipes 5\4\3\2\1\0
{2,0x3F}, //Enable RX Addresses pipes
//5\4\3\2\1\0
{3,0x03}, //RX/TX address field width 5 bytes
{4,0xFF}, //auto retransmission delay
// (4000us), auto retransmission
//count (15)

```

```

{5,0x0A}, //2.410GHz
{6,0x07}, //data rate-1M,out power 5dbm,high
//LNA gain,for LMX-ISM-242 bit 4
//must set to 0
{7,0x07}, //Status
{8,0x00}, //Observe TX
{9,0x00}, //Carrier Detect
{12,0xC3}, //LSB Receive address for data pipe
//2, MSB byte = RX_ADDR_P1 bits
//[39:8]
{13,0xC4}, //LSB Receive address fpr data pipe
//3, MSB byte = RX_ADDR_P1 bits
//[39:8]
{14,0xC5}, //LSB Receive address for data pipe
//4, MSB byte = RX_ADDR_P1 bits
//[39:8]
{15,0xC6}, //LSB Receive address for data pipe
//5, MSB byte = RX_ADDR_P1 bits
//[39:8]
{17,0x20}, //Number of bytes in RX payload in
//data pipe0 (32 BYTES)
{18,0x20}, //Number of bytes in RX payload in
//data pipe1 (32 BYTES)
{19,0x20}, //Number of bytes in RX payload in
//data pipe2 (32 BYTES)
{20,0x20}, //Number of bytes in RX payload in
//data pipe3 (32 BYTES)
{21,0x20}, //Number of bytes in RX payload in
//data pipe4 (32 BYTES)
{22,0x20}, //Number of bytes in RX payload in
//data pipe5 (32 BYTES)
{23,0x00}, //FIFO Status
{28,0x3F}, //Enable dynamic payload length data
//pipes 5\4\3\2\1\0
{29,0x07 //Enables Dynamic Payload Length,
//Payload with ACK,W_TX_PAYLOAD_NOACK
//command
};

```

The Register Bank 0 data is arranged as register address, register data. The bit values represented here will become crystal clear when you compare them to the datasheet bit positions. Once you are comfortable with the bits and their meanings, the fog surrounding the register load routines in the *init* function will also lift.

## TRANSMITTING A PACKET

Now that we know how to manipulate the LMX-SR's register banks and push it into transmit or receive mode, all we need to send a packet is some data and an SPI driver:

```

void xmitPacket(BYTE cmd, BYTE *buf, BYTE len)
{
    BYTE fifostat,i;

    txMode();

    fifostat = spi_rd_reg(FIFO_STATUS);
    if((fifostat & FIFO_STATUS_TX_FULL) == 0)
    {
        bit_clear(rCSN);
        SSP1BUF = cmd;
        while(!bit_test(BF));
        wr_status = SSP1BUF;
        for(i=0; i<len; i++)
        {
            SSP1BUF = buf[i];
            while(!bit_test(BF));
            wr_status = SSP1BUF;
        }
    }
}

```

```

        bit_set(rCSN);
        redON;
        delay_ms(100);
        redOFF;
    }
}

```

The *xmitPacket* function can be summoned with this line of code:

```
xmitPacket(W_TX_PAYLOAD_NOACK_CMD,packetBuf,17);
```

The *W\_TX\_PAYLOAD\_NOACK\_CMD* is an LMX-SR command that instructs the LMX-SR to send a packet without expecting an acknowledgement. The *packetBuf* contains the packet payload. In this case, the packet payload is 17 bytes long. Once transmit mode has been entered, we must check the LMX-SR's TX FIFO. If the *FIFO\_STATUS\_TX\_FULL* bit is clear, we can proceed with our packet transmission.

Transmitting a packet involves utilizing the LMX-SR's SPI portal. The LMX-SR is configured as an SPI slave. With that, we must select the LMX-SR by driving its CSN (Chip Select Not) pin logically low. The LMX-SR is expecting a command to be sent before the payload data. So, we'll drop the *W\_TX\_PAYLOAD\_NOACK\_CMD* command byte into the PIC's SPI buffer. The command has left the building and a status byte from the slave

## RF Specialists

### Affordable RF Modules

Introducing the LMX-ISM-242-SR and LMX-ISM-242-LR



### Data Loggers

Stand Alone and Wireless Mesh Networking Logger



### Industrial Bluetooth

OEM, Modules, Wireless Device Servers, RS-232 Long range options, low cost



### ZigBee Pro

OEM Modules and USB ZigBee Sticks, Mesh Networks



### Low Power, High Performance

### Semiconductors

Excellent Sensitivity, Very Efficient Power Amplifiers

Narrow Band, General Purpose, TSSOP, RF Microcontrollers

Typical Sensitivities are in the range of -110dBm to -126 dBm for 1.2 kbps

### RF Design Services

Prepared to work with your in-house engineers, or support your RF project from initial design to implementation. Industrial • Military • Space • Medical • Smart Grid Metering • SCADA • Lighting Control



**LE MOS**  
INTERNATIONAL

www.lemosint.com  
866.345.3667  
sales@lemosint.com

"Making your RF ideas into profitable products."





## THE LMX-ISM-242 DEVELOPMENT BOARD

All of that LMX-ISM-242 driver code is just another bucket of bits without some supporting hardware. A development board is available to complement the LMX-ISM-242 driver and provide you with a developmental boost. As you can see in **Schematic 1**, the development board is a USB-enabled wireless development system built around a Microchip PIC18F46J13.

This board offers a pair of programmable pushbutton switches, a quad of LEDs, and a header for attaching external devices. The PIC18F46J13 features an internal RTCC and the development board takes advantage of it. Its USB portal is realized with an industry standard FTDI FT232RL.

The FT232RL enables the LMX-ISM-242 developer to communicate with the development board using a PC. A 10-pin 1.27 mm female header allows you to plug in an LMX-SR or an LMX-LR data radio. The development board is shown with an LMX-SR mounted in **Photo 2**.

The LMX-ISM-242 is a low-power radio designed for embedded sensor applications. Battery power and embedded sensor applications seem to always show up at the same place. Our development board is equipped with an onboard MCP1703 voltage regulator that is being fed from the USB portal.

However, the MCP1703 and its USB benefactor can be isolated to allow the development board to be powered by a 3.0 volt battery pack. You can also isolate the USB power to allow the battery power to be regulated by the MCP1703.

## WHAT'S NEXT

The development board looks to be the final word in LMX-ISM-242 development. However, it's not the final word in the creation of additional LMX-ISM-242 projects. When we discuss this series of data radios again, we'll concentrate on mixing the LMX-SRs and LMX-LRs with microcontrollers and sensors on dedicated field-ready embedded platforms.

The LMX-SR gives you the power to design and build a license free, postage stamp sized smart RF platform. It's a tiny — but powerful — addition to your Design Cycle.

**NV**

bit, and the *MAX\_RT* bit. Obviously, we're interested in the *RX\_DR* bit. So, despite the *IRQ* pin status, we still do a double-check on the interrupt source. This check begins with a read of the *STATUS* register. Writing a 1 to the three interrupt bits will clear them. If we read the *STATUS* register and the *RX\_DR* bit is set, all we have to do is write back the original value to the *STATUS* register to clear the *RX\_DR* bit.

According to our previously listed Register Bank 0 initialization values, Dynamic Payload Length (DPL) is enabled. That means we can use the *R\_RX\_PL\_WID* command to read the six bits of packet length data from the nine-bit packet control area of the incoming packet. Once we know how many bytes make up the packet payload, we can issue SPI reads until the LMX-SR's *RX FIFO* is empty.

The receive process is completed with a CRC check followed by a write to the *STATUS* register to clear the interrupt bits. Everything I just said is translated to code here:

```
//*****
//* RECEIVE PACKET
//*****
void recvPacket(void)
{
    BYTE i,rstat,fifostat,chksum;
    //get current status
    rstat = spi_rd_reg(STATUS);
    //check for receive data ready (RX_DR)
    //interrupt
    if((STATUS_RX_DR & rstat) == 0x40)
    {
        togRed;
        do
        {
            msglen = spi_rd_reg(R_RX_PL_WID_CMD);
            if(msglen <= MAX_PACKET_LEN && msglen
            0)
            {
                spi_rd_buf(RD_RX_PLOAD,rxBuf,msglen);
            }
            else
            {
                spi_wrt_cmd(FLUSH_RX,0);
            }

            fifostat = spi_rd_reg(FIFO_STATUS);
        }while((fifostat & FIFO_STATUS_RX_EMPTY)
        == 0); //while not empty

        chksum = 0;
        for(i=0;i<16;i++)
        {
            chksum += rxBuf[i];
        }
        if(chksum == rxBuf[16] && rxBuf[0]== 0x30)
        {
            bluON;
            delay_ms(100);
            bluOFF;
        }
    }
    // clear RX_DR or TX_DS or MAX_RT interrupt
    // flags
    spi_wrt_reg(STATUS,rstat);
}
```

**Lemos International**

LMX-ISM-242-SR

LMX-ISM-242-LR

LMX-ISM-242 Development Board

LMX-ISM-242 Driver Source Code

[www.lemosint.com](http://www.lemosint.com)

Model 324

# WORLD'S MOST VERSATILE CIRCUIT BOARD HOLDERS

Our line of Circuit Board Holders add versatility & precision to your DIY electronics project. Solder, assemble & organize with ease.

**MONTHLY CONTEST**  
Visit us on Facebook® to post a photo of your creative PanaVise project for a chance to win a PanaVise prize package.

**PANAVISE®**  
Innovative Holding Solutions

7540 Colbert Drive • Reno • Nevada 89511  
**1 (800) 759-7535** | [www.PanaVise.com](http://www.PanaVise.com)

Model 201

VISIT US ON  

## Save Up To 60% On Electronic Components

### Ultrasonic Range Finder

- Measures up to 3M
- Suitable for Arduino and Most Microcontrollers
- No Set-Up Required

**Only \$14.90**

### Dual Battery Solar Charger

- Automatically Switches From One Battery to the Other, Once Charging is Complete
- High Efficiency Charging with PWM
- Suitable for Both 12V and 24V Systems

**Only \$42.90**

### Mini USB Board

- Includes FTDI FT232RL USB to UART Converter
- Easy USB Interfacing for Your Microcontroller System
- Suitable for Both 3.3V and 5V Microcontrollers

**Only \$12.90**

We are your one-stop shop for Microcontroller Boards, PCB Manufacture and Electronic Components

**[www.futurlec.com](http://www.futurlec.com)**



THE ORIGINAL SINCE 1994  
**PCB-POOL®**  
Beta LAYOUT

**FREE Stencil**  
with every prototype order

**EAGLE order button**  
[pcb-pool.com/download-button](http://pcb-pool.com/download-button)  
**20% off!** on your first order

Call Tyler: 1 707 447 7744  
[sales@pcb-pool.us](mailto:sales@pcb-pool.us)

PCB-POOL® is a registered trademark of **Beta LAYOUT**

**[www.pcb-pool.com](http://www.pcb-pool.com)**

# RS485/422/232/TTL

ASC24T  
RS232<=>RS485 ATE Converter

IBS485HV  
5 Port Isolated RS485 Repeater  
\$349.00

Enclosures, Cables, Power Supplies and other Accessories

\$45.00 board only

Converters / Repeaters  
Multi-Repeaters / Hubs  
Fiber Optics / Isolators  
Extended Distance Units  
Serial to Digital I/O  
Large Multi-Drop Networks  
Custom Units & Smart Units  
Industrial, 3.0 KV Isolation  
Call the RS485 Wizards  
**513-874-4796**

**RES** = R.E. Smith Inc.  
**[www.rs485.com](http://www.rs485.com)**

**2012 CD Now Available !!**

**Free Shipping!**

**8 CD-ROMs & Hat Special**  
Only \$ 169.95 or \$24.95 each.  
[www.servomagazine.com](http://www.servomagazine.com)

**\$51<sup>For 3</sup> PCBs**

**FREE Layout Software!**  
**FREE Schematic Software!**

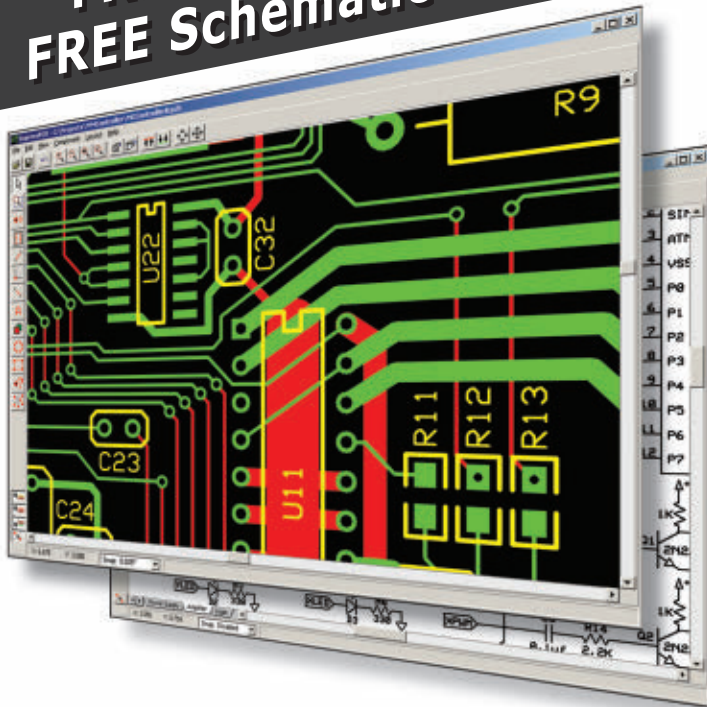

- 01 DOWNLOAD our free CAD software
- 02 DESIGN your two or four layer PC board
- 03 SEND us your design with just a click
- 04 RECEIVE top quality boards in just days

[expresspcb.com](http://expresspcb.com)

# BitScope

## Digital + Analog



### 100 MHz Digital Oscilloscope

- ✓ Dual Channel Digital Storage Oscilloscope with up to 12 bit analog sample resolution and high speed real-time waveform display.

### 40 MSPS x 8 Channel Logic Analyzer

- ✓ Captures eight logic/timing signals together with sophisticated cross-triggers for precise multi-channel mixed signal measurements.

### Serial Logic and Protocol Analyzer

- ✓ Capture and analyze SPI, CAN, I2C, UART & logic timing concurrently with analog. Solve complex system control problems with ease.

### Real-Time Spectrum Analyzer

- ✓ Display analog waveforms and their spectra simultaneously in real-time. Baseband or RF signals with variable bandwidth control.

### Waveform and Logic Generators

- ✓ Generate an arbitrary waveform and capture analog & digital signals concurrently or create programmable logic and/or protocol patterns.

### Multi-Channel Chart Recorder

- ✓ Record to disk anything BitScope can capture. Allows off-line replay and waveform analysis. Export captured waveforms and logic signals.

### Protocol Analyzer



### Digital Oscilloscope



### Spectrum Analyzer

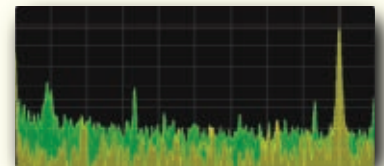

Compatible with major operating systems including Windows, Linux & Mac OS X, Pocket Analyzer is your ideal test and measurement companion.

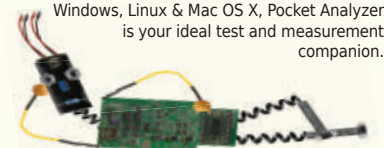

[bitscope.com/nv](http://bitscope.com/nv)

## NEW LIFE FOR AN OLD LCD

If memory serves me, the mid-90s saw a boom in cell phone use and one of the most popular brands on the market was Nokia. Yes, I had one too. While those phones seem absolutely stone age compared to the smart phones we use today, back then the multi-line, semi-graphical LCD was a welcome upgrade from the single-line LCD/LEDs previously used on phones and pagers. Thankfully, these displays have very long lives and are readily available for us to add to our designs.

The displays we're looking for specifically use the Philips PCD8544 matrix LCD driver/controller. Of course, if you do a Web search on this device, you will find loads of Arduino code which seem to be modifications of an original program written by Sylvain Bissonnette. After reviewing the Bissonnette code and a few of the Arduino variants (to see what high-level functions are popular), I decided it would be a fairly straightforward exercise to create my own driver in PASM (for speed).

If you're wondering, yes. An interface could be coded in Spin and for many applications this would be fine. For my projects, however, I want the ability to create a "screen" in a graphics application and load it right into the LCD without a significant delay. In fact, by using PASM and some pre-built "screens," simple animations are possible.

### LIKE A SHIFT REGISTER

As this is going to get a little involved, let's jump right in. From the controller's point-of-view, the PCD8544 looks like an output shift register with an extra

pin (DC, for data/command). This pin determines how the byte shifted into the display is interpreted (0 for command, 1 for data). This may seem familiar; you'll probably remember that parallel LCDs have a pin called RS that serves the same purpose.

Figure 1 shows the relationship between the signals responsible for moving data into the display. We'll start by taking the SCE (chip enable) pin low, setting the DC pin as required, then clocking in eight bits, MSB first. After all, bytes have been shifted to the display so the SCE pin is brought back high. Yep, it's pretty easy. There is a fifth pin into the chip — RST, an active-low reset line. When we first initialize the display, we'll pull this line low for about a millisecond to clear internal registers. This is required by the PCD8544.

Modules using the PCD8544 driver and an 84 x 48 LCD are available from a few sources, but I prefer the one from Adafruit. The unit is inexpensive (\$10) and uses a transistor circuit to control the LED backlighting — this means we don't have to worry about current out of a Propeller pin. Since we're going to the trouble of writing a

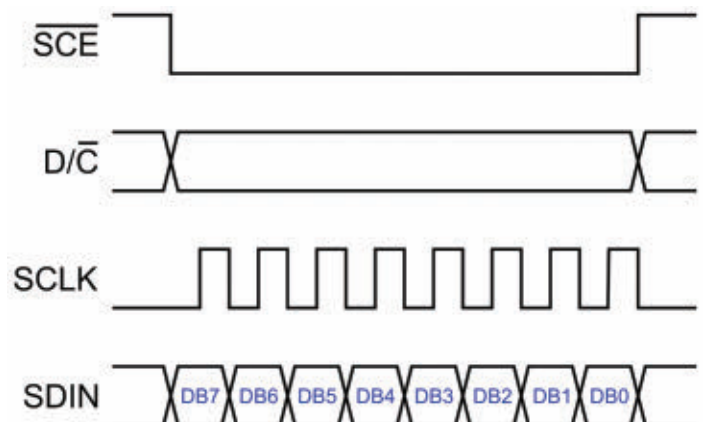

■ FIGURE 1. Serial protocol.



4..0	Driver command
5	DC bit, 0: command, 1: data
6	Normal (0) or Inverted (1) data
15..7	Byte count
31..16	Data byte or hub address

■ FIGURE 4. Command bits.

In addition to these features, the object supports very limited graphics capability, specifically the writing of one or more bytes to the display RAM. As I pointed out earlier, a character is written by copying the map of bytes that form that character to the display. Since we're using PASM anyway, we're going to work as much functionality in there as we can which affects how we call the driver. In a typical text driver, a string function looks like this:

```
pub str(p_str)
    repeat strsize(p_str)
        tx(byte[p_str++])
```

This code (taken from a standard serial driver) runs in a loop to write the string one character at a time. In order to expedite string and block output, I designed the PASM interface to accept a single byte or the address of the block of bytes.

How do we do that? Well, we can take advantage of the native 32-bit variable size and pack it with all the information we need to pass to the driver. **Figure 4** shows how the bits in the command (a long) will be interpreted by the driver. The methods in our Spin interface will pack these bits as required and move them to *command*. When the PASM cog sees a non-zero value in *command*, it unpacks the bits and performs the desired operation.

Most of the parameters passed to the PASM cog are LCD interface pins which need to be converted to a pin mask and then set to output mode:

```
mov    t1, par
add    t1, #4
rdlong t2, t1
mov    rstmask, #1
shl   rstmask, t2
or     outa, rstmask
or     dira, rstmask
```

This snippet copies the *par* register (which holds the hub address of *command*) into *t1* which is then used by the rest of the setup as the hub address pointer. We add four to skip over *par* which points us to the RST pin number. That gets read into *t2* which is used to create a bit mask for the pin using the *shl* instruction. Finally, the pin is set to an output high state (RST disabled) by OR'ing the mask with the *outa* and *dira* registers.

This same process is used for the other LCD control pins. The LED backlight pin is optional, so it gets handled a little differently:

```
add    t1, #4
rdlong t2, t1
cmps   t2, #0    wc, wz
if_b   mov    ledmask, #0
if_b   add    t1, #8
if_b   jmp    #getmaps
        mov    ledmask, #1
        shl   ledmask, t2
        or    dira, ledmask
```

After reading the LED pin into *t2*, we do a signed compare (*cmps*) to see if its value is less than zero. If that's the case, we move zero into the mask, then increment *t1* (hub pointer) by eight to skip over the next two parameters before jumping to *#getmaps*. If the LED is used (*t2* is 0 or higher), then a mask is created and the pin is set to output mode.

After I had the basic driver working, I made a change. Originally, the LED control was simply on and off. This is fine, but I thought that as I'm already in PASM I could use one of the counters to do PWM to control LED brightness. To do fixed-frequency PWM with a counter, we need to use NCO mode and update the counter inside a fixed loop that runs at the period set by the PWM frequency. The system frequency is divided by the desired PWM frequency (375 Hz) to determine the number of clock ticks in the PWM period:

```
add    t1, #4
rdlong looptix, t1
add    t1, #4
mov    levelhub, t1

add    t2, NCO_SE
mov    frqb, #1
mov    ctrb, t2
```

When the LED is used, we'll read the period (in ticks) into *looptix* and then save the pointer to the brightness level setting in *levelhub*. Next, we'll set up *ctrb* for NCO mode using the LED pin (still in *t2*).

Let's stop here for a second. By using this strategy, we will require the same amount of time to run — the delay is caused by waiting for the PWM period to time out. The code is constructed such that when the LED is not used

by the PCD8544 driver, the code loop will run as fast as it can. During testing, I put the driver into this mode and then timed the various methods to determine how fast everything runs. It came as no surprise that the right-justified decimal output of **negx** across an entire line took the longest; about 2.6 ms. This equates to the maximum PWM frequency of 384 Hz, so I used 375 to give the code a bit of overhead. Please keep in mind that my testing was at a system frequency of 80 MHz; if you're doing a low-power application that uses a slower clock and you still want LED control, you'll need to adjust the PWM frequency constant.

Okay, after collecting the final parameter (address of character maps), the code initializes the loop time for use in PWM control and then jumps to **#cmdexit**:

```
cmdexit      or      outa, scemask
             mov      cmd, #0
             wrlong   cmd, par

updateled    tjz     ledmask, #getcommand

             waitcnt  looptimer, looptix
             rdlong   phsb, levelhub
             jmp      #getcommand
```

The purpose of this section is to deselect the LCD and then write zero to the command value to let the Spin interface know that the driver is ready for another command. Just after that, we check the LED mask for zero (LED not used) and if that's the case jump right back to the top. When the mask is not zero (LED is in use), then we allow the PWM loop timer to expire, reload that timer, and reload the counter with the brightness value which is in the hub.

For those of you desiring simple on-off control of the LED backlight, there is no problem. Pass -1 as the LED pin number to the **.start()** method to disable PWM, and then control the LED pin manually (high for on, low for off) from your mainline code. This is how I was able to light the display while running my timing tests.

As I stated earlier, the PCD8544 looks like a shift register to a microcontroller, so we're going to need SPI type code to move data to it. We can write this using basic PASM instructions; being assembly, it will run very fast. For additional speed, we can take advantage of one of the counters running NCO mode.

In the setup section, there is this bit of code that is associated with the SDIN (serial data) pin:

```
add      t2, NCO_SE
mov      frqa, #0
mov      phsa, #0
mov      ctra, t2
```

In this case we're setting **ctrA** to run NCO mode but notice that we're putting 0 into the **frqa** register. When

the counter is running NCO mode, the value in **frqa** is added to **phsa** every clock tick and bit 31 of **phsa** is copied to the output pin. In this case, **phsa** will not auto-increment with 0 in **frqa**. Here's how we can put the counter to use for faster SPI output code:

```
shiftout      shl      outbyte, #(32 - 8)
              mov      phsa, outbyte
              mov      bits, #8

:loop         or      outa, sckmask
              shl      phsa, #1
              andn    outa, sckmask
              djnz    bits, #:loop

shiftout_ret  ret
```

We start by aligning the MSB of the byte to shift out with bit 31 by shifting it left 24 bits. This is then moved into the **phsa** register which will cause whatever is in bit 31 to appear on the SDIN pin. We set up a bit counter and then drop into a loop that takes the clock line high. It is on this edge that the new bit (on SDIN) is clocked into the PCD89544. The next instruction shifts the value in **phsa** left by one to get the next bit (and move it to SDIN). We take the clock line low, decrement the bit count, and continue until finished.

This is pretty nifty code and is really fast which helps us move a lot of data to the display. To give you an idea, when I first started experimenting with the LCD I wrote a simple Spin driver. It took well over 100 milliseconds to fill the display. By using the PASM driver and the fast shiftout, that display fill time dropped to just over one millisecond. Of course, I would love to have you believe that I'm the clever guy that came up with this — of course, you know I'm not. This is one of those great tidbits one learns by participating in the Propeller forum on the Parallax website.

Now that we've seen some of the low-level mechanics, let's have a look at the processing of a command from the user code. Let's say that we want to write a custom character to the present cursor location on the screen. We know that we'll need a map of six bytes to define the character. For my demo program, I created a degrees symbol like this:

## RESOURCES

**JON "JONNYMAC"  
MCPHALEN**  
[jon@jonmcp halen.com](mailto:jon@jonmcp halen.com)

**PARALLAX, INC.**  
Propeller chips and  
programming tools  
[www.parallax.com](http://www.parallax.com)

**ADAFRUIT INDUSTRIES**  
Nokia 5110/3310  
LCD Module (#338)  
prototyping supplies  
[www.adafruit.com](http://www.adafruit.com)

**LCD ASSISTANT**  
[http://en.radzio.dxp.pl/  
bitmap\\_converter](http://en.radzio.dxp.pl/bitmap_converter)

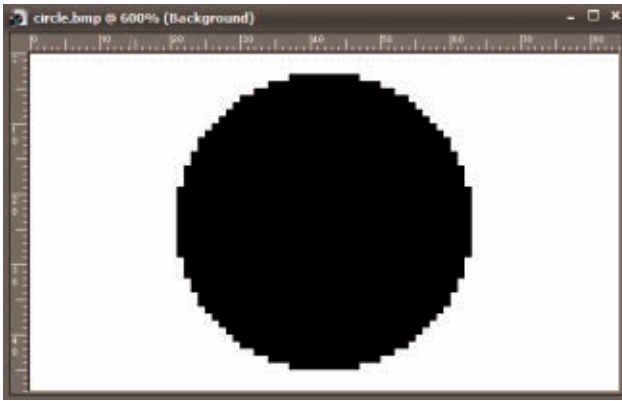

■ FIGURE 5. Normal aspect ratio.

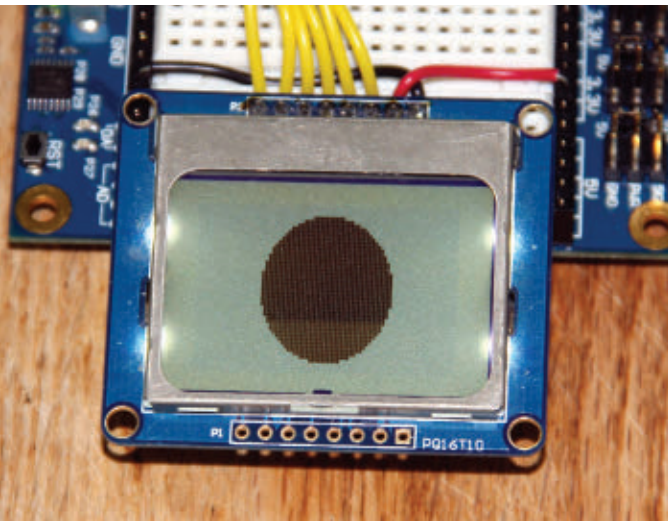

■ FIGURE 6. Bad aspect display.

```
DegSym      byte    $06, $09, $09, $06,
             $00, $00
```

We could also do it like this:

```
DegSym      byte    %00000110
             byte    %00001001
             byte    %00001001
             byte    %00000110
             byte    %00000000
             byte    %00000000
```

This helps us visualize the custom character — so long as we cock our heads to the right to align our eyes with the top of the character definition! In the high-level code, we'll use the `.put_glyph()` method to write the custom character. To write the degrees symbol, we would do this:

```
lcd.put_glyph(@DegSym, 6)
```

As you can see, we pass the definition address and the character width (five plus pad column). The interface

packs all of this information into `command` and passes it to the driver. Let's see how the driver takes the command value, unpacks it, and handles the user request.

Here's the top of the PASM loop:

```
getcommand      rdlong  cmd, par
                mov     uparms, cmd
                and     cmd, #$1F  wz
                if_z   jmp     #updateled

                max     cmd, #7
                add     cmd, #jumptable
                jmp     cmd

jumptable       jmp     #cmdexit
                jmp     #cmd_reset
                jmp     #cmd_wr_byte
                jmp     #cmd_wr_count
                jmp     #cmd_wr_block
                jmp     #cmd_wr_char
                jmp     #cmd_wr_str
```

We read the command value from the hub and make a copy in `uparms`. The command is AND'ed with `$1F` to strip off all but the handler selection bits. If the result is zero (no command), we jump right to `#updateled` which checks for LED use and handles PWM updating (we covered this earlier). Assuming we have a handler request, we truncate the value to what's actually in the code. The `max` instruction limits the value in `cmd` which causes the jump to find `#cmdexit` for anything greater than six.

With a valid request, we add the cog address of the jump table to create what is — in effect — the equivalent of a PBASIC **BRANCH** instruction. This causes the program to jump to the appropriate handler code. At the end of each handler section, we jump to `#cmdexit` to disconnect from the LCD and update PWM (if enabled). The `.put_glyph()` method uses the code at `#cmd_wr_block`; let's have a look at it:

```
cmd_wr_block    andn    outa, scemask
                test   uparms, #DC_BIT  wz
                muxc   outa, dcmask
                mov    t1, uparms
                shr    t1, #16
                mov    t2, uparms
                shr    t2, #7
                and    t2, #$1FF
                test   uparms, #INV_BIT  wz

:loop          rdbyte  outbyte, t1
                if_nz  xor    outbyte, #$FF
                call   #shiftout
                add    t1, #1
                djnz   t2, #:loop
                jmp    #cmdexit
```



The handler code starts by taking the SCE pin low, then copying the DC bit into the Carry flag and using **muxc** to set the DC output. For a graphics block, we're using data mode so this pin will be high.

Next, we copy *uparms* (original command and data) into *t1* and shift it left by 16 bits. What this leaves in *t1* is the hub address of our graphics data. We make another copy of *uparms* in *t2*, shift it left by seven, and then mask with \$1FF. What we have in *t2* is the number of bytes in the block. Finally, we test the invert bit and save that in the Z flag before dropping into the loop that writes the bytes.

At the top of this loop, we read a byte from the hub. If inversion was specified, then we XOR the byte with \$FF to invert the bits. This byte is passed to **shiftout** to be moved to the display RAM. We don't have to worry about the LCD address counter as it is automatically incremented with every write.

After writing the byte, we increment the hub pointer in *t1*, then decrement the byte count in *t2* and continue until all bytes have been written.

Once you've grasped the block write code, the rest of the handlers will make sense. Writing an ASCII character or string requires a little more work as we have to convert the ASCII character to a table offset for the character maps. Once this is done, however, the code is identical to writing a six-byte block. Enough grunt stuff.

Let's put this display to use. I connected mine to a Prop-BOE and used the following pin definitions:

```
LED = 5
SDIN = 4
SSCK = 3
DC = 2
SCE = 1
RST = 0
```

To get things going — and assuming we want PWM control of the backlight LEDs — we can call the `start` method like this:

```
lcd.start(RST, LED)
```

Remember, if a project is forced to use non-contiguous pins we always use the `.startx()` method and pass all pin numbers to the driver. Let's say we want to put a simple message on the screen:

```
lcd.clear
lcd.str(string(" Nuts & Volts! "))
```

As you can probably tell, writing to the PCD8544 LCD object is just like writing to any other character-based object.

Since we have full control of writing text and there is an inverted option, we can mix normal and inverted text in the same display:

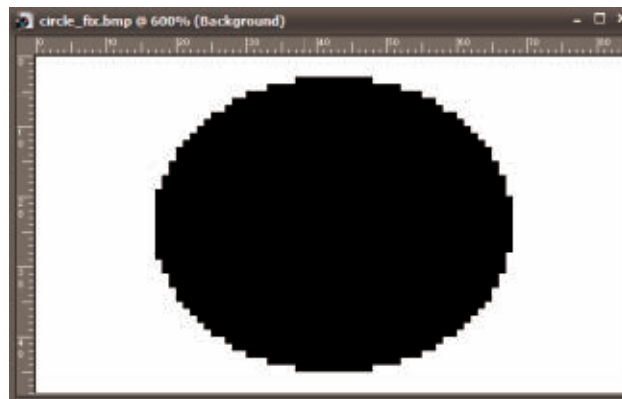

■ FIGURE 7. Adjusted aspect ratio.

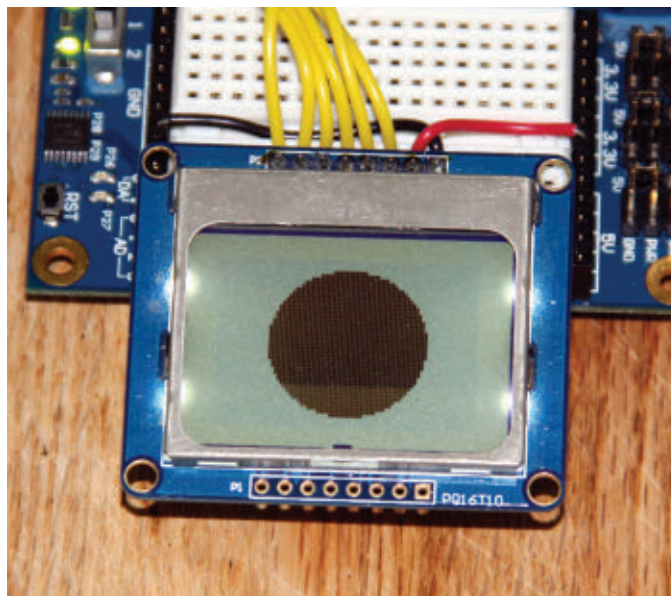

■ FIGURE 8. Correct aspect display.

```
lcd.char_xy(0, 1)
lcd.set_style(lcd#INVERT)
lcd.str(string(" Nuts & Volts "))
```

This bit of code moves to the next line and then writes the same string using inverted mode. By mixing normal and inverted modes, we can create interesting and effective displays.

## PRACTICAL GRAPHICS

With this display, we can create complex output by building a bitmapped background in our favorite graphics editor, converting it to a suitable pixel map, and then writing to the display.

If you're not a heavy graphics user, I want to warn you of a problem that can be very frustrating when creating custom graphics for the LCD. Our computers have a pixel aspect ratio of 1:1 while the LCD used in the module is about 0.83:1. What this means is that if we create a

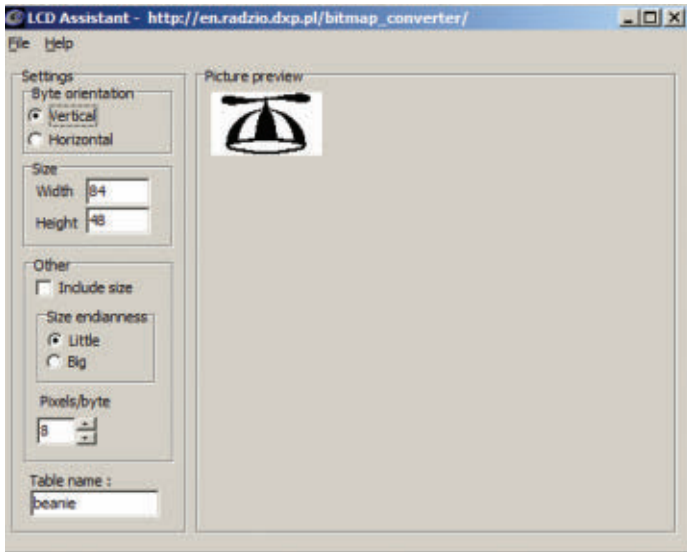

■ FIGURE 9. LCD Assistant.

graphic — like the one in **Figure 5** — then translate that to a table for the display, what we’re going to end up with is what you see in **Figure 6**. *What?!*

In simple terms, the pixels in the LCD are narrower than the pixels in our PC monitors so objects that look normal on the PC will look “skinny” in the LCD (*if only I could do that with my mirror*). The way to fix this for correct output with the LCD is to scale the X axis by 120%. Remember to re-crop the image to 84 pixels wide after doing this. **Figure 7** shows the corrected image and as you can see in **Figure 8**, what looks “fat” in the PC program displays normally in the LCD.

At this point, you’re probably wondering how we convert a bitmap into a data map for the program. There is a piece of freeware called *LCD Assistant* that will do the

first part of the translation. Open the bitmap with the program and keep the default settings (as in **Figure 9**). Select **Save Output** from the **File** menu and enter the name of the file in the dialog. I saved it as a standard text file. This is just step one.

Open the text file in the Propeller Tool and do the following:

- Delete all non-data lines.
- Convert ‘0x’ (hex header) to ‘\$’ (for Spin) using Find/Replace.
- Delete trailing commas on all data lines.
- Add a “byte” type designator to each line.

The first line of the table will — of course — include a name so we can point to it. The lines will look something like this, though only the first has a label:

```
Circle      byte      $00, $00, $00, $00 ...
```

Admittedly, it is a little work to finish the conversion but “smart” block selection (using the Alt key) and pasting can simplify the process. With practice, you can easily convert the raw output from *LCD Assistant* to a useful Spin table in about 30 seconds.

## THAT’S A WRAP

Well, that’s about it for this time. As always, please download and explore the demonstration and driver code at the article link as it includes lots of helpful comments. The demo puts the LCD through its paces and gives you a good launching point for including this display in your projects. Happy New Year! Until next time, keep spinning and winning with the Propeller! **NV**



**PBP3**  
PICBASIC PRO™ Compiler

**Experimenter - \$49.95**  
**Silver Edition - \$119.95**  
**Gold Edition - \$269.95**

The industry-standard BASIC compiler for Microchip PIC® microcontrollers.

**Multi-Seat Licensing**  
for Educational Institutions

**Upgrade from**  
PICBASIC™ Compiler (PBC)

Download a FREE trial version now.

**www.PBP3.com**

**microEngineering Labs, Inc.**

**www.melabs.com**

**888-316-1753**

PICBASIC and PICBASIC PRO are trademarks of Microchip Technology Inc. in the USA and other countries. PIC is a registered trademark of Microchip Technology Inc. in the USA and other countries.

# ELECTRONET

**GET THE NUTS & VOLTS DISCOUNT!**  
 Mention or enter coupon code **NVRMZ12**  
 and receive 10% off your order!

**ramsey**  
[www.ramseykits.com](http://www.ramseykits.com)  
 AM/FM Broadcasters • Hobby Kits  
 Learning Kits • Test Equipment  
 ...AND LOTS OF NEAT STUFF!

THE ORIGINAL SINCE 1994  
**PCB-POOL**  
 Beta LAYOUT

- Low Cost PCB prototypes
- Free laser SMT stencil with all Proto orders

[WWW.PCB-POOL.COM](http://WWW.PCB-POOL.COM)

**INVEST in your BOT!**

**HiTEC**  
 INVEST in  
 12115 Paine Street • Poway, CA 92064 • 858-748-6948 • [www.hitecrd.com](http://www.hitecrd.com)

For the ElectroNet  
 online, go to  
**[www.nutsvolts.com](http://www.nutsvolts.com)**  
 click **Electro-Net**

**ALL ELECTRONICS**  
 CORPORATION  
 Electronic Parts & Supplies  
 Since 1967

Got electronics?  
**[www.nutsvolts.com](http://www.nutsvolts.com)**

**Proto Buddy Book & Kit Combo**

DO-IT-YOURSELF  
**Circuitbuilding FOR DUMMIES**

Includes an article reprint!

**Only \$59.95**

For complete details visit our webstore @ [www.nutsvolts.com](http://www.nutsvolts.com)

**[www.canakit.com](http://www.canakit.com)**

- Over 200 Kits & Modules to choose from!
- Easy Worldwide Online Ordering
- Fast Delivery & Same Day Shipping

FM Transmitters • Timers • Audio Amplifiers • Motor Controllers

**USB** Add USB to your next project--  
 It's easier than you might think!

**DLP Design**

USB-FIFO • USB-UART • USB/Microcontroller Boards  
 RFID Readers • Design/Manufacturing Services Available  
*Absolutely NO driver software development required!*

[www.dlpdesign.com](http://www.dlpdesign.com)

**superbrightleds.com**

Component LEDs - LED Replacement Bulbs - LED Accent Lighting

Super Bright LEDs Inc. St. Louis, Missouri - USA [superbrightleds.com](http://superbrightleds.com)

**Microcontroller Boards**

GREAT for Breadboards, Home Projects, Experiments, Test Fixtures, Prototypes, Labs and more.  
 Microcontrollers, Communications, Display, Power.  
**BASIC ON BOARD Eliminates development tools**

**ATRIA Technologies Inc**  
[www.AtriaTechnologies.com](http://www.AtriaTechnologies.com)

**Pololu**  
 Robotics & Electronics  
**[WWW.POLOLU.COM](http://WWW.POLOLU.COM)**

Serial LCD & LED  
[www.melabs.com](http://www.melabs.com)

**Beginner's Guide Complete Combo!**

Beginner's Guide to Embedded C Programming

Includes:  
 • 3 Books  
 • 2 CD-ROMs  
 • 1 Experiment Kit

**Combo Price \$229.95**

VOL 3 Experiment Component Pack

For complete details, visit our webstore @ [www.nutsvolts.com](http://www.nutsvolts.com).

# The Nuts & Volts **WEBSTORE**

## GREAT FOR DIYers!

### Digital Filmmaking for Beginners A Practical Guide to Video Production by Michael Hughes

Discover how to create professional-quality digital videos — faster than you can say "lights, camera, action." Digital video cameras are everywhere — even on our phones! But cameras don't make great movies;

filmmakers do. Written by a seasoned pro with 40 years of teaching experience, *Digital Filmmaking for Beginners* is your fully illustrated introduction to all technical aspects of digital filmmaking.

**\$24.95**

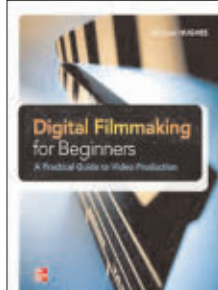

### How to Diagnose and Fix Everything Electronic by Michael Jay Geier

#### Master the Art of Electronics Repair!

In this hands-on guide, a lifelong electronics repair guru shares his tested techniques and invaluable insights.

*How to Diagnose and Fix Everything Electronic* shows you

how to repair and extend the life of all kinds of solid-state devices, from modern digital gadgetry to cherished analog products of yesteryear. **About the Author:** Michael Jay Geier began operating a neighborhood electronics repair service at age eight that was profiled in *The Miami News*.

**\$24.95**



### Basic Electronics for Tomorrow's Inventors

by Nick Dossis



Learn all about electronics with hands-on experiments and projects.

This great book features a variety of simple, solder-free projects, including an LED reading light, electronic security keypad, IR target practice game, a real working telephone, temperature and moisture sensors, spy gadgets, and other neat stuff. Best of all, these experiments require only plug-and-play "breadboards" and other commonly available parts.

**\$19.95**

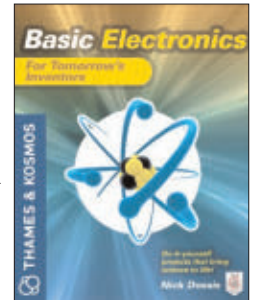

### Electronics An Introduction by Jim Stewart

This book is designed as an in-depth introduction to important concepts in electronics. While electronics can be highly mathematical, this text is not about calculations. It is about how electronic

equipment is able to extract, process, and present information held in electrical signals. If you are in — or studying to be in — a profession that requires the use of electronic equipment, then this book will provide the insight necessary to use such equipment effectively.

**\$33.95\***

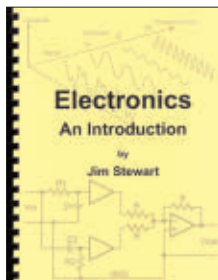

### Build Your Own Electronics Workshop by Thomas Petruzzellis

**BUILD YOUR OWN DREAM ELECTRONICS LAB!**

This value-packed resource provides everything needed to put together a fully functioning home electronics workshop! From finding space to stocking it with components to putting the shop into action — building, testing, and troubleshooting systems. This great book has it all! And the best part is, it shows you how to build many pieces of equipment yourself and save money, big time!

**Reg Price \$29.95  
Sale Price \$26.95**



### Beginner's Guide to ... Programming the PIC24/dsPIC33 by Thomas Kibalo

Kibalo takes you step by step through the fundamentals of programming the PIC24H which can equally be applied to the dsPIC33.

His clear explanation of the inner workings make learning the PIC24H/dsPIC33

16-bit architecture easy. His code examples demonstrate how to perform the functions most applications require. The hardware is shown in a simple breadboard setup so even a beginner can build it, along with very few extra components needed.

**\$39.95\***



### HTML: A Beginner's Guide by Wendy Willard

Create highly functional, impressive websites in no time. Fully updated and revised, *HTML: A Beginner's Guide*, Fourth Edition explains how to structure a page, place images, format text, create links, add color, work with multimedia, and use forms. You'll also go beyond the basics and learn how to save your own web graphics, use Cascading Style Sheets (CSS), create dynamic web content with basic JavaScript, and upload your site to the web. By the end of the book, you'll be able to build custom websites using the latest HTML techniques.

**\$29.95**



### Programming PICs in Basic by Chuck Hellebuyck

If you wanted to learn how to program microcontrollers, then you've found the right book! Microchip PIC microcontrollers are being designed into electronics throughout the world and none is more popular than the eight-pin version. Now the home hobbyist can create projects with these little microcontrollers using a low cost development tool called the CHIPAXE system and the Basic software language. Chuck Hellebuyck introduces how to use this development setup to build useful projects with an eight-pin PIC12F683 microcontroller. **\$14.95**



### Master and Command C for PIC MCUs by Fred Eady

*Master and Command C for PIC MCU, Volume I* aims to help readers get the most out of the Custom Computer Services C compiler for PIC microcontrollers.

The author describes some basic compiler operations that will help programmers particularly those new to the craft create solid code that lends itself to easy debugging and testing. As Eady notes in his preface, a single built-in CCS compiler call (output\_bit) can serve as a basic aid to let programmers know about the "health" of their PIC code. **\$14.95**



Order online @ [www.store.nutsvolts.com](http://www.store.nutsvolts.com)  
 Or CALL 1-800-783-4624 today!

**BOOK & KIT COMBOS**

**Proto Buddy Book & Kit Combo**

Includes an article reprint!

**Only \$59.95**

For complete details visit our webstore @ [www.nutsvolts.com](http://www.nutsvolts.com)

**Beginner's Guide Complete Combo!**

**Combo Price \$229.95**

For complete details, visit our webstore @ [www.nutsvolts.com](http://www.nutsvolts.com).

**An Arduino Workshop**

Puzzled by the Arduino?

An Arduino Workshop \$44.95  
 Projects Kit \$84.95  
 Book+Kit Combo \$124.95

Joe Pardue  
[SmileyMkrm.com](http://SmileyMkrm.com)

**Learn C Programming?**

C Programming for Microcontrollers \$44.95  
 Projects Kit \$58.49  
 Book+Kit Combo \$99.95

C Programming for Microcontrollers  
 Featuring AVR's 8-bit AVR and the PIC18C4520

Joe Pardue  
 SmileyMkrm.com

**Arduino Proto Shield**

Prototyping Shield Kit includes PCB, mini breadboard and stacking headers

**\$16.95**

**From Smiley's Workshop**

**CD-ROM SPECIAL**

**Nuts & Volts 8 CD-ROMs & Hat Special!**

That's 96 issues. Complete with supporting code and media files.

**Free Shipping!**

**Only \$169.95**  
 or \$24.95 each.

Published monthly by T & L Publications, Inc. [www.nutsvolts.com](http://www.nutsvolts.com)

**The Nuts & Volts Pocket Ref**

All the info you need at your fingertips!

This great little book is a concise all-purpose reference featuring hundreds of tables, maps, formulas, constants & conversions. AND it still fits in your shirt pocket!

**Only \$12.95**

Visit <http://store.nutsvolts.com> or call (800) 783-4624

**PROJECTS**

**Seismograph Kit**

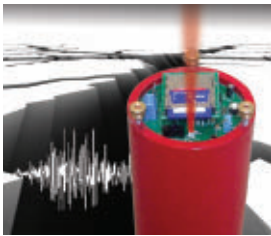

**As seen in the May 2012 issue.**

Now you can record your own shaking, rattling, and rolling.

The Poor Man's Seismograph is a great project /device to record any movement in an area where you normally shouldn't have any. The kit includes everything needed to build the seismograph. All you need is your PC, SD card, and to download the free software to view the seismic event graph.

**Subscriber's Price \$79.95**  
**Non-Subscriber's Price \$84.95**

**3D LED Cube Kit**

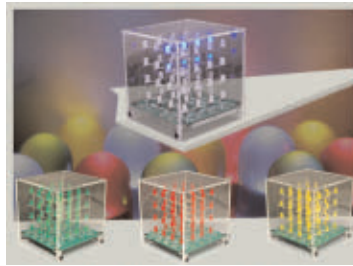

This kit shows you how to build a really cool 3D cube with a 4 x 4 x 4 monochromatic LED matrix which has a total of 64 LEDs. The preprogrammed microcontroller that includes 29 patterns that will automatically play with a runtime of approximately 6-1/2 minutes. Colors available: Green, Red, Yellow & Blue

**Subscriber's Price \$57.95**  
**Non-Subscriber's Price \$59.95**

**Battery Marvel Kit**

**As seen in the November 2011 issue.**

Battery Marvel helps protect cars, trucks, motorcycles, boats, and any other 12V



vehicles from sudden battery failure. This easy-to-build kit features a single LED that glows green, yellow, or red, indicating battery health at a glance. An extra-loud piezo driver alerts you to any problems.

**For more info, please visit our website.**

**Subscriber's Price \$18.95**  
**Non-Subscriber's Price \$19.95**

**Neon Transistor Clock Kit**

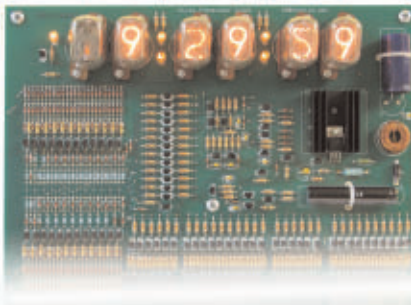

*Add HIGH VOLTAGE to your clock!*

This is a Nixie Tube display version of the Transistor Clock. It uses only discrete components — no integrated circuits.

For more info, see the April 2012 issue.

**Subscriber's Price \$245.95**  
**Non-Subscriber's Price \$249.95**

**Sorting Counter Kit**



*As seen in the July 2011 issue.*

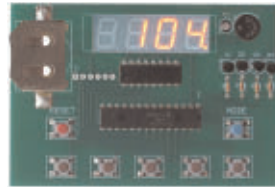

Sorting counters have many uses — keeping score, counting parts, counting people — it is just a handy gadget to have around. This is a very simple project for those who want to learn to solder or are interested in using microprocessors and how they function. No special tools are needed, just a small tip soldering iron. It has no box as it stands alone, therefore there is no drilling.

**Subscriber's Price \$33.95**  
**Non-Subscriber's Price \$39.95**

**Magic Box Kit**

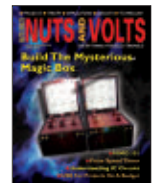

*As seen on the April 2007 cover.*

This unique DIY construction project blends electronics technology with carefully planned handcraftsmanship. This clever trick has the observer remove one of six pawns while you are out of the room and upon re-entering you indicate the missing pawn without ever opening the box.

**Subscriber's Price \$39.95**  
**Non-Subscriber's Price \$45.95**

**FOR BEGINNER GEEKS!**

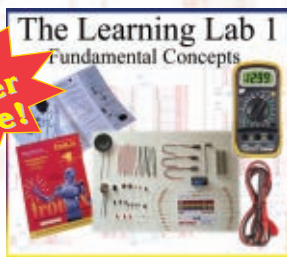

**\$59.95**

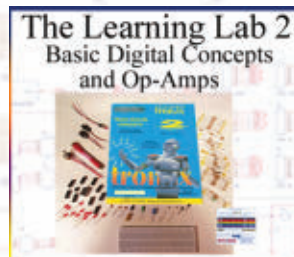

**\$49.95**

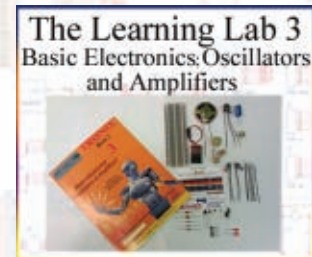

**\$39.95**

The labs in this series — from GSS Tech Ed — show simple and interesting experiments and lessons, all done on a solderless circuit board.

As you do each experiment, you learn how basic components work in a circuit, and continue to build your arsenal of knowledge with each successive experiment.

**For more info and a promotional video, please visit our webstore.**

# CLASSIFIEDS

## KITS/PLANS

### Electronic Kits

- Fun and Educational
- Discount White and Blue LEDs
- Quantity Discounts

www.bakatronics.com

## LIGHTING



## SURPLUS

### SURPLUS ELECTRONIC PARTS & ACCESSORIES

Over 20,000 Items in Stock.

Cables	Hardware	Relays	Switches
Connectors	LEDs	Semiconductors	Test Equipment
Displays	Motors	Service Manuals	Tools
Fans	Potentiometers	Speakers	VCR Parts

Surplus Material Components  
SMC ELECTRONICS  
www.smcelectronics.com

No Minimum Order.  
Credit Cards and PAYPAL Accepted.  
Flat \$4.95 per order USA Shipping.

## HARDWARE WANTED

### DEC EQUIPMENT WANTED!!!

Digital Equipment Corp. and compatibles.  
Buy - Sell - Trade

CALL KEYWAYS 937-847-2300  
or email [buyer@keyways.com](mailto:buyer@keyways.com)

## WANT TO BUY

### WANT TO BUY: WHOLESALE OR MANUFACTURING COMPANY

Inventory, machinery, equipment, cars, trucks, airplane, trailers, estates. ANYTHING CONSIDERED. CALL! NO COST OR OBLIGATION!  
ISE: YOUR NUMBER 1 LIQUIDATOR.  
956-444-0004 FREE: 888-351-5550  
www.iseliquidator.com

## CHIP PROGRAMMERS

### LOGICAL DEVICES, INC.



Universal USB Programmer \$195.00!!  
www.logicaldevices.com  
Tel:303-923-8080 support@logicaldevices.com

## ENERGY SOLUTIONS

Save Money On Your Electric Bill  
www.sunny-solutions-shop.com  
800-315-0309

## COMPONENTS

### RF PARTS™ CO.

RF Tubes, Transistors, Power Components  
Email: [rpf@rfparts.com](mailto:rpf@rfparts.com) • Web: [www.rfparts.com](http://www.rfparts.com)  
800-737-2787 Fax 888-744-1943

### uM-FPU64 64-bit Floating Point Coprocessor



64-bit and 32-bit IEEE 754 compatible  
SPI or I2C interface, 3.3V Supply, 5V Tolerant I/O  
Extensive floating point support, FFT, matrix operations  
GPS input, local device support, Flash functions, IDE

Robotics Navigation  
Sensor Modules Embedded Systems

Additional products...  
uM-FPU V3.1 32-bit FPU  
uM-PWM1 Servo Coprocessor

www.micromegacorp.com

## ENGINEERING/ DESIGN SVCS

### DEVELOTECH, INC.

IP, PCB & Circuit Design,  
Firmware, Smart Sensors,  
Test, Low Quantity Builds  
NV@DEVELOTECH.NET  
Orlando, FL 407.756.6823

### FLEXREV China Direct Manufacturing

Turn Key or Subassemblies  
Components, Enclosures, Keypads

\$0.007 per soldering point  
2 layer PCBs \$0.14/in2  
Small jobs welcome

FLEXREV.COM

## ROBOTICS

### MaxSonar Ultrasonic Ranging is EZ

LV-ProxSonar-EZ  
• People Sensing  
• Made Easy  
• Proximity Sensor  
• MSRP \$29.95

HRXL-MaxSonar-WR (IP67)  
• 1-mm resolution  
• Industrial packaging  
• Weather resistant  
• MSRP \$109.95

I2CXL-MaxSonar-EZ  
• Great for UAV's  
• I2C Interface  
• High acoustic power  
• Starting at \$39.95

I2CXL-MaxSonar-WRC (IP67)  
• I2C interface  
• Compact packaging  
• Weather resistant  
• MSRP \$109.95

www.maxbotix.com

## QKITS.COM

AVR Treasure Finder Robot kit detects metal, stops and beeps!



\$46.95 USD

1-888-GO 4 KITS

## READER FEEDBACK

Continued from page 9

stitched together to create this full color self-portrait.

The mosaic shows the rover at "Rocknest" – the spot in Gale Crater where the mission's first scoop sampling took place. Four scoop scars can be seen in the regolith in front of the rover.

The base of Gale Crater's three mile high (five kilometer) sedimentary mountain – Mount Sharp – rises on the right side of the frame. Mountains in the background to the left are the northern wall of Gale Crater. The Martian landscape appears inverted within the round,

reflective ChemCam instrument at the top of the rover's mast. Self-portraits like this one document the state of the rover and allow mission engineers to track changes over time, such as dust accumulation and wheel wear. Due to its location on the end of the robotic arm, only MAHLI (among the rover's 17 cameras) is able to image some parts of the craft, including the port side wheels.

It's pretty interesting to actually see it on the surface of Mars ... Jeff

Subscribe today!

www.nutsvolts.com

## USING THE NEARSPACE SIMPLE FLIGHT COMPUTER

Last time, we covered building the NearSpace Simple-18 flight computer. Now, it's time to test and learn how to use it prior to its first near space launch. This flight computer — like the others I've written about — are for amateur radio use only. You need to be a licensed amateur radio operator to use it. I will write about an unlicensed version of this flight computer soon.

### BATTERY FOR THE NEARSPACE SIMPLE-18

You need to select a battery that's at least six volts for the flight computer, and then solder wires to the PCB (printed circuit board) so that you can connect the battery to the flight computer. The battery must work well when cold and its connection to the flight computer must lock securely so that shaking cannot disconnect it during a mission.

Lithium-polymer batteries are not as sensitive to the cold as alkaline batteries. A secure battery connection is important for R/C racing cars, so therefore, rechargeable R/C LiPo batteries are ideal for this flight computer.

I didn't include a power switch in this design to help to reduce the risks of a flight computer failure. So, the flight computer starts up as soon as the battery is connected. The job of the mission recovery crew will be to unplug the battery to shut down the flight computer.

### TESTING THE NEARSPACE SIMPLE-18

Be sure there are no shorts on the PCB, and check that every port and IC socket works. Look over the soldered connections on the bottom of the PCB and verify that none of them overflow the solder pads and touch non-connected neighbors.

After completing a visual inspection, perform the first electrical test by searching for a possible short between power and ground. Set a multimeter to continuity, and check between the positive and negative terminals of the flight computer's battery connector. If the multimeter does not ring, it's safe to connect the battery to the flight computer.

For the second test, connect the battery and set the multimeter to measure voltage (at a scale that can measure at least five volts). Test each of the five volt and ground points in the flight computer. **Figure 1** indicates where you will measure +5 volts (within 1/4 of a volt) and ground.

### USING THE NEARSPACE SIMPLE-18

The NearSpace Simple-18 uses a TinyTrak APRS tracker for tracking and recovering the mission. It uses the PICAXE-18M2 for operating experiments and collecting data. There are two ports on the flight computer for programming, and four ports for interfacing sensors and experiments. Four LEDs indicate the status of the NearSpace Simple-18. Let me now describe these ports and LED indicators to prepare you to use the flight computer.

### INTERFACE PORTS

The first port is the GPS port



Discuss this article in the *Nuts & Volts* forums at <http://forum.nutsvolts.com>.

**FIGURE 1.** The voltage test points of the NearSpace Simple-18 are marked with red and green blocks. The red blocks are +5 volts and the green blocks are ground. The non-colored blocks are there for reference only; do not test these points.

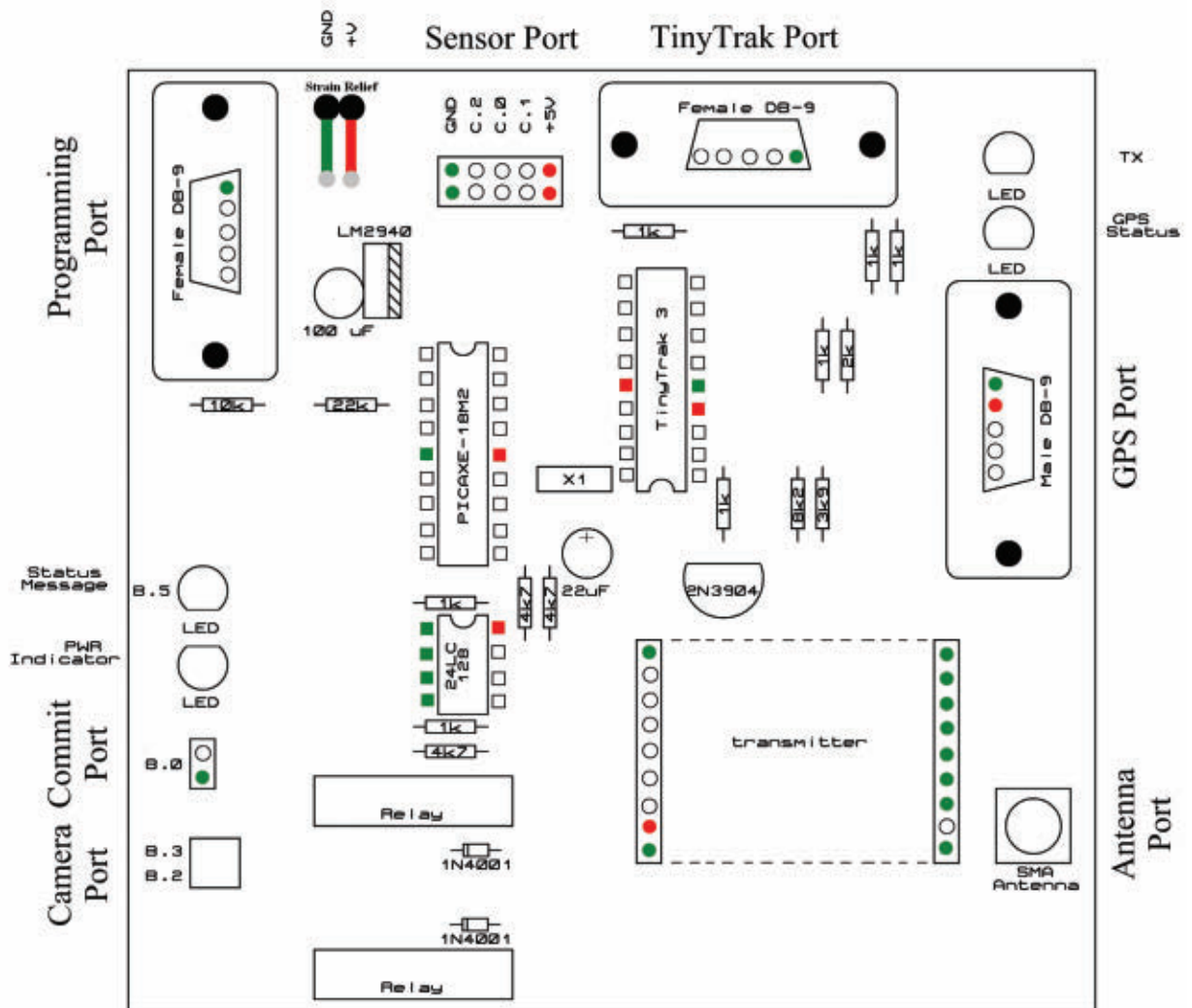

which both the PICAXE and the TinyTrak share. The GPS port's primary purpose is to provide position data for the APRS tracker. Its secondary purpose is to provide position data – like altitude – to the PICAXE-18M2 in support of its experiments.

The port provides a regulated five volts to the GPS receiver through pin 4 of the GPS DB-9 connector. This eliminates the need for a separate battery for the GPS receiver.

Disconnect the GPS when programming the TinyTrak because a connected GPS receiver will prevent the TinyTrak from receiving its configuration settings.

The second port is the sensor port. Both digital and analog sensors

plug into this port, and it connects the sensors to three of the PICAXE-18M2's I/O pins. In addition, the port provides five volts and ground to operate the sensors.

The port is a two by five pin receptacle because that provides better strength and stability than a one by five receptacle can. The left and right sides of the receptacle are the pins that provide five volts and ground to the sensors. Ideally, sensors for the flight computer will consist of an array of three sensors with shared power and ground.

The third port is the camera port. There are two pairs of connections in this port which allow the flight computer to operate two cameras. It connects cameras to the two relays

on the PCB. The relays replace the shutter switch in most digital cameras and permit the PICAXE to trigger the camera to take a picture. How to modify a camera for this depends on the camera. However, you need to open the camera and locate the shutter switch contacts.

Solder two thin wires to the contacts and run them outside the camera body. If you soldered the wires properly, the camera will take a picture when you touch together the bare ends of the wires. Terminate the wires with a two-pin receptacle (a receptacle like the three-pin receptacle of a servo) and plug the camera cable into the camera port.

Note that there may be times when you want the camera port to

turn the camera on and off that is taking the pictures. Switching off the camera may be an issue with smart cameras whose battery saver mode shuts the camera off during periods of perceived inactivity.

This could also be an issue with video cameras that will only record

for a maximum length of time before shutting off. With cameras like these, the NearSpace Simple-18 can use one camera connection to shut the camera on and off, and the second connection to trigger the shutter or restart the video recording. This requires you to access the camera's

power switch the same way that you accessed the shutter switch. The connections will be similar and shouldn't be very difficult to complete.

The last port is the mission commit port. It's used to signal the PICAXE-18M2 to start the mission. This means that you can power-up the flight computer at the start of filling the balloon without recording data on the ground. Then, just prior to launch — after verifying the GPS has a satellite lock — remove the commit pin and begin recording data. The result is that your flight computer does not waste memory recording data on the ground.

## LED INDICATORS

The four LED indicators in the NearSpace Simple-18 provide a quick perspective on the status of the flight computer. The LEDs indicate status by either being on, off, or by blinking. The first LED indicator is the power indicator. It's illuminated when the battery is connected to the flight computer.

The second is the status indicator. This LED connects to the PICAXE and is programmable. You can program the PICAXE to use the LED to signal anything you desire by having the PICAXE-18M2 turn it on, turn it off, or blink it.

The last two LED indicators are part of the TinyTrak APRS tracker. One LED illuminates for a second while the TinyTrak is transmitting a position report. This is useful when troubleshooting a transmitter or receiver error.

The last LED indicator is the GPS status indicator. This LED has three states. It's off when a GPS is not plugged into the port. The LED blinks when the GPS is connected to the flight computer, but hasn't acquired a satellite lock. The GPS indicator LED is continuously illuminated when the GPS has a position lock. Never launch a near spacecraft when this LED is off or blinking.



# Sabertooth 2x60

## Dual 60A Continuous Brushed Motor Controller

**Specifications:**

- 60A Continuous, 120A peak current
- 6V - 33.8V input voltage range (8s lipo max)
- Analog, RC (PWM), and Serial Interface
- Overcurrent, overvoltage, undervoltage, and overheat protection built in
- Fan cooling keeps the controller cool
- Heavy duty terminals take up to 2 gauge wire
- 1 year warranty on every Sabertooth
- DEScribe Software Suite Compatible



ONLY  
\$189.99

- [www.dimensionengineering.com/Sabertooth2x60.htm](http://www.dimensionengineering.com/Sabertooth2x60.htm) - 899 Moe Dr. #21 Akron, OH 44310 - 330-634-1430 -

## INJECTION MOLDING MACHINE - \$595

This unique accessory turns your drill press into an injection molding machine. Price includes injector, heater, digital temperature controller, plastic pellets, plus a sample mold and illustrated 24-page instruction manual.





**MOLD YOUR OWN PLASTIC PARTS**



Inventors, do prototyping, mold fishing lures or more! Video on our webpage:

[www.techkits.com/pim](http://www.techkits.com/pim)

## AMAZING KITS!

- BINARY CLOCK
- HIGH VOLTAGE
- NIXIES
- JUMBO LED CLOCK
- STEPPER MOTOR DRIVES
- DIGITAL THERMOMETER

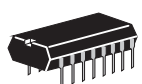
- ION MOTOR
- LEVITATOR
- SOLAR KITS

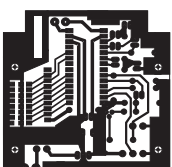

All skill levels. Step-by-step manuals. Details on our webpage:

[www.techkits.com/kits](http://www.techkits.com/kits)

## PROGRAMMING PORTS

The two programming ports change the behavior of the NearSpace Simple-18. The programming port not only programs the PICAXE, but also allows it to download data. The TinyTrak port is not used as frequently as the programming port. It's used to download the operating parameters to the TinyTrak APRS tracker.

The PICAXE-18M2 is programmed using the PICAXE Editor from [www.picaxe.com](http://www.picaxe.com), and the TinyTrak is programmed using the free configuration software created by Byonics ([www.byonics.com](http://www.byonics.com)).

## PROGRAMMING THE NEARSPACE SIMPLE-18

The following code snippets are enough to get you started programming the NearSpace Simple-18. Refer to the PICAXE programming guide that comes with the PICAXE Editor for a full explanation of these commands.

The following snippet keeps the flight computer in a loop until the commit pin is removed. Use it to prevent the flight computer from beginning a mission prior to the launch of the near spacecraft:

```
Commit:
IF PINB.0 = 0 THEN Commit
```

The following snippet turns the status LED on or off. Use this code when you want the flight computer to signal a mission status. You can loop this code and add pauses to create a blinking status LED indicator:

```
HIGH B.5
LOW B.5
```

The flight computer triggers the cameras to take pictures with this snippet:

```
HIGH B.2
PAUSE 1000
LOW B.2
```

You can record pictures with the

second camera by using **B.3** in place of **B.2**.

Before data can be stored into memory, the PICAXE must be configured for I<sup>2</sup>C communication with the 24LC128 memory.

The IC operates at 400 kHz and stores data in one word wide

records. The following snippet configures the PICAXE to the proper I<sup>2</sup>C setting:

```
I2CSLAVE %10100000,
I2CFAST, I2CWORD
```

After setting the PICAXE-18M2 for I<sup>2</sup>C communication, data can be

## The new Star Controller: POWER OF THE GODS.

Well, the power of Lenny,  
Zeus' doofus brother and  
God of Blinky Things.

Power it up with 4~13VDC, and use 5V logic (up to 80kHz PWM) to create a dazzling RGB light source. It's the safe and simple way to add a powerful full-color illumination to your project.

Price: **\$22<sup>00</sup>**  
SKU: 60160



PS: He likes to hang out with Mike,  
God of Clicky Buttons.



**SOLARBOTICS**  
solarbotics.com 1-866-276-2687

## NIGHTFIRE ELECTRONICS KITS

<http://vakits.com>

### 352-390-6195

Hours:  
9AM to 6PM EST

Component Kits	Electronic Kits
Resistor Kits	PIC Kits
Capacitor Kits	LED Kits
Diode Kits	Timer Kits
Transistor Kits	Power Supply Kits
Hardware	Relay Kits
Thru-Hole & SMT	Audio Kits

**Free Shipping for orders  
over \$39.99 (USA & Canada)**

Celebrating 10 Years! Family Owned!



I've included a fix to the PCB copper mask for the NearSpace Simple-18 because there was an error in the ground connection to one of the DB-9 connectors. That error has been corrected in this copy of the copper mask. A file is available at the article link.

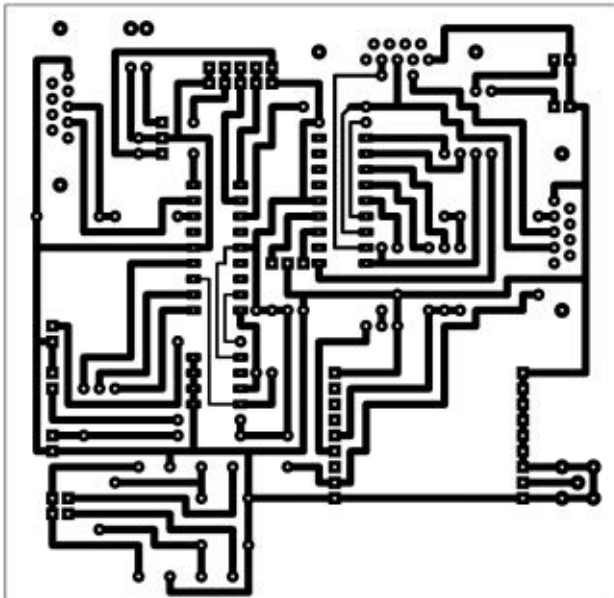

stored into memory with this code snippet:

```
WRITEI2C Address, (B6,B7)
```

Note that the variable **Address** is one word in size and points to the memory location where the next two bytes of data (**B6** and **B7**) are stored. Unless you want to waste storage space, store data using both bytes. I recommend using the PICAXE Editor's Terminal program to display the stored flight data. To get the data out of memory, set the PICAXE terminal to 4800 baud and use this:

```
SERTXD ("Start,")
FOR Record = 0 to 4091 STEP 2
READI2C Record, (B1,B0)
SERTXD (#B0, ",", #B1, ",")
NEXT
```

Notice that this code begins by displaying the message "Start." Then, it downloads the data two bytes at a time with a comma between each byte. If the flight program stores data in one word variables, then use this code instead:

```
SERTXD ("Start,")
FOR Record = 0 to 4091 STEP 2
READI2C Record, (W0)
SERTXD (#W0, ",")
NEXT
```

**ezP!ck**  
VACUUM  
PICK AND PLACE  
SYSTEM

**ABACOM**  
TECHNOLOGIES

www.abacom-tech.com

**AP CIRCUITS**  
PCB Fabrication Since 1984

As low as...  
**\$9.95**  
each!

Two Boards  
Two Layers  
Two Masks  
One Legend

*Unmasked boards ship next day!*

**www.apcircuits.com**

VISA MasterCard PayPal IPC MEMBER BBB

Because the 24LC128 memory stores data in one word records, it's best to digitize two analog voltages before storing flight data into memory.

If you don't, the flight program will store a one byte record into memory and waste half of the 24LC128 memory space. Convert sensor voltages into one byte records (eight bits) with the following code snippet:

```
READADC C.0,B0
```

**C.0** is the I/O pin whose sensor voltage is being digitized by the command. The result is stored into RAM memory in byte **B0**. The other I/O pins connected to the sensor port are **C.1** and **C.2**.

The PICAXE can convert analog voltages into a 10-bit reading and store the result of the conversion into one word. Six bits are wasted when 10-bit data is stored as a word, but

the data has four times the resolution of an eight-bit conversion. Use the following code snippet to digitize sensor voltages with 10 bits of resolution:

```
READADC10 C.0,W0
```

## PROGRAMMING THE TINYTRAK

Consult the configuration editor's guide when using the software. The TinyTrak's configuration settings include things like the radio call sign, the APRS path for the transmission of data, and the period of the position reports.

Please consult your local amateur radio club when setting up the flight computer's transmission path. That way, your near spacecraft will not excessively interfere with the local APRS traffic.

Don't forget — you must be a licensed amateur radio operator to

use the GPS tracking feature of this flight computer unless you swap the radio for one using a non-licensed frequency.

If you are not currently a licensed ham, contact your local club for help earning a license. The process is much simpler these days and very rewarding.

## FINAL APPROACH

That does it for the NearSpace Simple-18. Next time, I will discuss how to incorporate the flight computer into a simple airframe.

If you would rather purchase a NearSpace Simple-18 kit rather than make one from the PCB up, check my catalog at [nearsys.com/catalog](http://nearsys.com/catalog). You will also find that the website carries a GPS receiver kit that is suitable for the NearSpace Simple-18.

Onwards and Upwards,  
Your near space guide **NV**

# GET THE MESSAGE.

The CU200211-Y1A/Y100 allows you to read across the room

LARGE AND BRIGHT VFD  
READS OVER 10ft AWAY

### Features:

- Readable from over 10ft away
- More visible with brightness boost
- Convenient wide viewing angle

Actual  
size:

ABCD  
0123

For more about the CU200211-Y1A/Y100 visit:

<http://itron.tv/NV0113>

*Noritake* **itron**  
The brighter side of electronics

Noritake Co., Inc.  
2635 Clearbrook Drive  
Arlington Heights, IL 60005  
(847) 439-9020

flexibility, along with the high-performance and low-power required by customers.

The new FM4 family covers the highest end of the product range with DSP and FPU capabilities not available in the FM3 family. All products in the FM4 family will be equipped with the FPU, along with SDRAM and SD card interface functions.

The FM4 series also features an expanded variety of packaging options, as well as a wide range of timers and serial communications functions. The devices integrate high quality and reliable Flash memory technology.

In addition to inverter control functions, various communication functions, CAN, USB 2.0, and Ethernet support, the FM4 family is equipped with high-speed serial communications functions and high-speed, high performance AD converters. These features make the FM4 products ideal for motor and

network controls in factory automation applications, as well as for inverters and other industrial equipment.

Functions that reduce power consumption are built into the microcontrollers, enabling the FM0+ family to target an operating current of 70  $\mu\text{A}/\text{MHz}$  and a standby current of just 0.7  $\mu\text{A}$  (in RTC mode).

The low power consumption makes the new MCUs ideal for portable devices or other power-constrained applications such as battery-operated devices and electronic meters, and sensor controls.

Fujitsu plans to begin releasing sample quantities of products in these new families starting in 2013, and will begin full-scale production of the line later in the year.

For more information, contact:  
**Fujitsu**  
Web: [www.fujitsu.com](http://www.fujitsu.com)

## GREEN ROOF MONITORING SYSTEM

Onset is now offering the HOBO® Green Roof Monitoring System — a research-grade system for measuring the performance of green roofs.

Providing reliable performance in harsh rooftop conditions, the 15-channel system enables users to quickly and easily monitor green roof conditions, measure stormwater runoff, improve irrigation scheduling,



## ALUMINUM END CAPS AND SERVO POWER TUBE GEARBOXES

New aluminum end caps from ServoCity fit into the end of their 1" x 1.5" tube gearboxes, and



allow users to attach any of their .770" pattern components to the gearbox. The end cap has a 1/2" center bore to allow tubing or shafting to extend inside of the

gearbox for added support. When using hollow tubing, it allows wires to be routed through the interior of the gearbox and down the hollow tube for a clean look. The end cap is constructed of 6061 T6 aluminum for strength. Using the end cap with a ServoCity tube gearbox and attaching it to a bottom mount gearbox (pictured) is used as a setup for antenna tracking systems.

ServoCity is also introducing a new patented SPG785A1-5 servo power tube gearbox. A stock HS-785HB servo can rotate 3.5 turns (1.75 turns left or right from center) or 1,260° total. When the HS-785HB servo is installed into this tube gearbox, the total amount of rotation is decreased but power and accuracy is increased. Position feedback remains since the internal potentiometer is not removed.

Choose the necessary gear ratio along with the amount of rotation an



application requires. The lower the gear ratio, the more precision and power is available, but with less rotation. The SPG785A1-5 can handle tremendous side loads with the dual ABEC-5 precision ball bearing supported 1" aluminum hollow shaft. The shaft is hollow to allow wires from cameras, sensors, or other devices to not tangle during multi-turn rotations. The frame of the SPG785A1-5 is machined from 6061-T6 aluminum (anodized) and offers ServoCity's 0.770" hub pattern in line with the output shaft.

For more information, contact:  
**ServoCity**  
Web: [www.servocity.com](http://www.servocity.com)

and maintain healthy rooftop vegetation.

Key advantages include:

- 24/7 web-based access to data.
- All the common green roof measurements: temperature, relative humidity, wind, soil moisture, light intensity, and rainfall.
- Plug-and-play sensors that enable fast easy deployment.
- Customizable data display for kiosks.
- Trend logging, monitoring, and alarm notifications.

The green roof monitoring system is available now, and includes a HOBO U30 GSM-cellular data logger with a one year service plan, smart sensors for measuring rainfall, soil moisture, soil temperature, solar radiation, air temperature/relative humidity, and wind speed and direction, as well as mounting

brackets and a six-watt solar panel. Optional mounting masts, tripods, graphing and analysis software, and additional sensors are also available.

For more information, contact:  
**Onset**  
Web: [www.onsetcomp.com](http://www.onsetcomp.com)



## HIGH ENERGY DENSITY DC LINK CAPACITORS

Cornell Dubilier announces the release of its type BLC high energy density board mount DC link capacitors for medium power inverter systems.

Type BLC capacitors are a good choice for demanding applications in inverters for wind and solar energy, electric vehicles, motor drives, UPS systems, and more.

Available in values of 8 to 55  $\mu$ F

and voltage ratings ranging from 700 to 1,100 VDC, type BLC DC link capacitors are packaged in UL94V-0 plastic boxes with four pins for low equivalent series resistance. These capacitors are designed for long life at high ripple current – up to 36A – with a demonstrable 25 year life under typical operating conditions.

For more information, contact:  
**Cornell Dubilier**  
Web: [www.cde.com](http://www.cde.com)

**NUTS AND VOLTS**

2012 CD-ROM  
Order yours today!  
Only \$24.95

**Free Shipping**

[www.nutsvolts.com](http://www.nutsvolts.com)

For personal use only.  
Copyright 2012-2013  
T & L Publications, Inc.  
All rights reserved.

May NOT be posted on  
a public or corporate  
Internet site.

**NUTS AND VOLTS**  
2012  
Volume 33, No. 1-12

## >>> QUESTIONS

Visit our Tech Forum online at [www.nutsvolts.com/tech-forum](http://www.nutsvolts.com/tech-forum) to view and answer new questions as they come in.

### Microcontroller Newbie

I'm just starting in electronics and have taught myself some of the basics through reading books and building kits. I'm intrigued with microcontroller projects and was hoping to get some seasoned opinions on where to start. There seem to be several popular platforms that get most of the attention such as Arduino, PIC, Stamp, Propeller, etc.

Which is best for a beginner?

Can someone recommend a book on programming that assumes zero experience and explains the basics from the start through getting a simple project up and running?

Are there any beginner-friendly online user groups I might join?

Any advice is appreciated.

**#1131** **J.P.**  
via email

### iPhone / X10 Control

Is there a way to operate my home X10 devices using my iPhone through my Wi-Fi network (preferred) or Bluetooth?

**#1132** **Anton Stamos**  
**Scottsdale, AZ**

### I Want My MP3

I want to play my MP3 player through my car stereo, but it does not have an auxilliary input to plug in at. It does, however, have a separate CD changer. Can I simply wire the CD changer and an audio jack for the MP3 player to a selector switch, and use them both on the CD input? Seems too easy. What am I missing or is there a better way?

**#1133** **Sam Friers**  
**Eugene, OR**

## >>> ANSWERS

### [#12121 - December 2012]

Does anyone have a schematic for a simple light meter? I'm trying to determine the difference in illumination provided by CFLs as opposed to incandescent light bulbs. I'm not too interested in the absolute value of the light hitting the surface, just the relative difference between the two.

**#12121** **Pete Schestopol**  
**Marietta, GA**

All you need is a small solar cell mounted in the end of a "toilet paper" tube. Make sure the cell's face "faces" inward, and that you seal the tube end containing the cell so it's (more or less) "light-proof." If you wish, paint the inside of the tube FLAT BLACK before mounting the solar cell (reduce any "internal reflections, etc." of the tube).

To use: Connect the solar cell's leads to the DMM (polarity is not important; all you want is the "absolute" display value) and set the DMM to the 2V scale. Darken the room and turn on the CFL you want to "measure." Wait a few minutes to allow the bulb to fully warm up, and point the open end of the tube at the glowing CFL. The voltage reading on the DMM display will give you the "relative brightness" indication you're looking for (i.e., "higher" voltage reading = brighter lamp).

**IMPORTANT:** Make sure you use the same measuring distance (i.e., one

inch) between the open end of the tube and each CFL you're measuring for best accuracy! Repeat for all CFLs you want to measure.

**Ken Simmons**  
**Auburn, WA**



### NEW! Nuts & Volts Mobile App!

You can now enjoy *Nuts & Volts Magazine* on-the-go from your mobile device. Our new mobile app is now live and available for iOS, Android, and Kindle Fire devices.

Right now, you can find the latest issues in the brilliant replica format that you know and love, and also text formatted articles designed for maximum readability on any size screen.

You can download each issue and return anytime to read offline. *Nuts & Volts* print subscribers get free access to any issues that are included in their subscription and available within the app. Other back issues are available through a special in-app purchase feature.

### Coming Soon

More back issues plus live feeds from [www.nutsvolts.com](http://www.nutsvolts.com) with news, projects, the Tech Forum, and other online bonus material delivered to you in real time.

Check it out now  
at your favorite App Store!

Send all questions and answers by email to [forum@nutsvolts.com](mailto:forum@nutsvolts.com) or via the online form at [www.nutsvolts.com/tech-forum](http://www.nutsvolts.com/tech-forum)

All questions AND answers are submitted by *Nuts & Volts* readers and are intended to promote the exchange of ideas and provide assistance for solving technical problems. All submissions are subject to editing and will be published on a space available basis if deemed suitable by the publisher. Answers are submitted

by readers and **NO GUARANTEES WHATSOEVER** are made by the publisher. The implementation of any answer printed in this column may require varying degrees of technical experience and should only be attempted by qualified individuals.

*Always use common sense and good judgment!*



# ADvertiser INDEX

## **AMATEUR RADIO AND TV**

NightFire Electronics .....75  
 Ramsey Electronics, Inc. ....82-83

## **BATTERIES/CHARGERS**

Cunard Associates .....31

## **BUSINESS OPPORTUNITIES**

Techkits.com .....74

## **BUYING ELECTRONIC SURPLUS**

Jaycar Electronics .....Back Cover  
 Weirdstuff Warehouse .....31

## **CCD CAMERAS/VIDEO**

Ramsey Electronics, Inc. ....82-83

## **CHIP ADAPTERS**

EZPrototypes .....13

## **CIRCUIT BOARDS**

AP Circuits .....76  
 Beyond Kinetics .....31  
 Butterfly Network, Inc. ....22  
 Cunard Associates .....31  
 Dimension Engineering.....74  
 ExpressPCB .....59  
 Front Panel Express LLC .....23  
 Futurlec .....58  
 PCB Pool .....58  
 R.E. Smith Inc. ....58  
 Saelig Company Inc. ....22  
 Target-3001.com .....9

## **COMPONENTS**

Can a Kit Corp. ....5  
 Electronix Express .....13  
 Futurlec .....58  
 NightFire Electronics.....75  
 Noritake .....77  
 SDP/SI .....31

## **COMPUTER**

### **Hardware**

EZSBC .....23  
 Noritake .....77  
 Weirdstuff Warehouse .....31

### **Microcontrollers / I/O Boards**

Abacom Technologies .....76  
 Beyond Kinetics .....31  
 Bitscope .....59  
 Butterfly Network, Inc. ....22  
 Gooligum Electronics .....31  
 microEngineering Labs .....66

MikroElektronika .....3  
 Pololu Robotics & Electronics.....4  
 Solarbotics/HVW .....75

### **Software**

MakerPlot.com .....31  
 Target-3001.com .....9

## **DESIGN/ENGINEERING/REPAIR SERVICES**

Can a Kit Corp. ....5  
 ExpressPCB .....59  
 Front Panel Express LLC .....23  
 PCB Pool .....58  
 Target-3001.com .....9

## **DRIVE COMPONENT CATALOGS**

SDP/SI .....31

## **EDUCATION**

Bitscope .....59  
 Command Productions .....35  
 Gooligum Electronics .....31  
 NKC Electronics .....31  
 Poscope .....45

## **EMBEDDED TOOLS**

NetBurner .....2

## **ENCLOSURES**

Front Panel Express LLC .....23

## **GRAPHICAL PLOTTING SOFTWARE**

MakerPlot.com .....31

## **GUI FOR MICROCONTROLLERS**

MakerPlot.com .....31

## **KITS & PLANS**

Can a Kit Corp. ....5  
 Gooligum Electronics .....31  
 Jaycar Electronics .....Back Cover  
 NetBurner .....2  
 NightFire Electronics.....75  
 NKC Electronics .....31  
 QKITS .....31  
 Ramsey Electronics, Inc. ....82-83  
 Solarbotics/HVW .....75  
 Techkits.com .....74

## **MISC./SURPLUS**

All Electronics Corp. ....7  
 Front Panel Express LLC .....23  
 Weirdstuff Warehouse .....31

## **OPTICS**

Noritake .....77

## **PROGRAMMERS**

Butterfly Network, Inc. ....22  
 Futurlec .....58  
 microEngineering Labs .....66  
 MikroElektronika .....3

## **PROTOTYPE BOARDS**

EZPrototypes .....13

## **RF TRANSMITTERS/RECEIVERS**

Abacom Technologies .....76

## **ROBOTICS**

Beyond Kinetics .....31  
 EZSBC .....23  
 Lemos International Co., Inc. ....55  
 Pololu Robotics & Electronics.....4  
 Robot Power .....31  
 SDP/SI .....31  
 Solarbotics/HVW .....75

## **SATELLITE**

Lemos International Co., Inc. ....55

## **SOLDERING STATIONS AND IRONS**

HAKKO .....27

## **TEST EQUIPMENT**

Bitscope .....59  
 Dimension Engineering.....74  
 Jaycar Electronics .....Back Cover  
 NKC Electronics .....31  
 Poscope .....45  
 Saelig Company Inc. ....22

## **TOOLS**

HAKKO .....27  
 MikroElektronika .....3  
 NetBurner .....2  
 PanaVise .....58  
 Poscope .....45  
 Techkits.com .....74

## **VIDEO/DISPLAY MODULES**

4D Systems .....51

## **WIRE, CABLE AND CONNECTORS**

EZPrototypes .....13

4D Systems .....51  
 Abacom Technologies .....76  
 All Electronics Corp. ....7  
 AP Circuits .....76  
 Beyond Kinetics .....31  
 Bitscope .....59  
 Butterfly Network, Inc. ....22  
 Can a Kit Corp. ....5  
 Command Productions .....35  
 Cunard Associates .....31  
 Dimension Engineering.....74  
 Electronix Express .....13  
 ExpressPCB .....59  
 EZPrototypes .....13  
 EZSBC .....23  
 Front Panel Express LLC .....23  
 Futurlec .....58  
 Gooligum Electronics .....31  
 HAKKO .....27  
 Jaycar Electronics ..Back Cover  
 Lemos International Co., Inc. ....55  
 MakerPlot.com .....31  
 microEngineering Labs .....66  
 MikroElektronika .....3  
 NetBurner .....2  
 NightFire Electronics.....75  
 NKC Electronics .....31  
 Noritake .....77  
 PanaVise .....58  
 PCB Pool .....58  
 Pololu Robotics & Electronics..4  
 Poscope .....45  
 QKITS .....31  
 Ramsey Electronics .....82-83  
 R.E. Smith Inc. ....58  
 Robot Power .....31  
 Saelig Company Inc. ....22  
 SDP/SI .....31  
 Solarbotics/HVW .....75  
 Target-3001.com .....9  
 Techkits.com .....74  
 Weirdstuff Warehouse .....31



## Electrocardiogram ECG Heart Monitor

- ✓ Visible and audible display of your heart rhythm!
- ✓ Bright LED "Beat" indicator for easy viewing!
- ✓ Re-usable hospital grade sensors included!
- ✓ Monitor output for professional scope display
- ✓ Simple and safe 9V battery operation



When we think of a New Year, we often start with our proverbial list of New Year's resolutions. Often starting with weight loss goals as a result of all the December holiday parties, (including the Buffalo Wings of course!) they typically also include a new attitude for a healthier life style. While we are frequently reminded that February is national Heart Smart month, we think the first of the Year is no better time to start! Every month should be Heart Smart month. Heart Smart is a way of life, and certainly shouldn't be limited to one month a year. We kept that in mind when we designed the ECG1!

Not only will building an actual ECG be a thrill, but you'll get hands-on knowledge of the relationship between electrical activity and the human body. Each time the human heart beats, the heart muscle causes small electrical changes across your skin. By monitoring and amplifying these changes, the ECG1C detects the heartbeat and allows you to accurately display it, and hear it, giving you a window into the inner workings of the human heart and body!

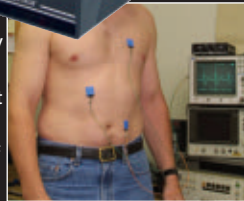

One of our engineers/guinea pigs, checking his heart!

Use the ECG1C to astound your physician with your knowledge of ECG/EKG systems. Enjoy learning about the inner workings of the heart while, at the same time, covering the stage-by-stage electronic circuit theory used in the kit to monitor it. The three probe wire pick-ups allow for easy application and experimentation without the cumbersome harness normally associated with ECG monitors.

The documentation with the ECG1C covers everything from the circuit description of the kit to the circuit description of the heart! Multiple "beat" indicators include a bright front panel LED that flashes with the actions of the heart along with an adjustable level audio speaker output that supports both mono and stereo hook-ups. In addition, a monitor output is provided to connect to any standard oscilloscope to view the traditional style ECG/EKG waveforms just like you see in a real ER or on one of the medical TV shows!

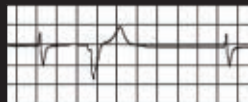

Look what I found!

On a personal note... See the display to the left? That's me! In between writing this monthly ad copy, catalog copy, and plethora of other tasks here, I noticed some skipped beats in my pulse! An immediate cardiac check found I had something called Trigeminy, or PVCs that occur at intervals of 2 normal beats to one PVC! And I saw it with our ECG1 kit!

The fully adjustable gain control on the front panel allows the user to custom tune the differential signal picked up by the probes giving you a perfect reading and display every time! 10 hospital grade re-usable probe patches are included together with the matching custom case set shown. Additional patches are available in 10-packs. Operates on a standard 9VDC battery (not included) for safe and simple operation. Note, while the ECG1C professionally monitors and displays your heart rhythms and functions, it is intended for hobbyist usage only. If you experience any cardiac symptoms, seek proper medical help immediately!



ECG1C	Electrocardiogram Heart Monitor Kit With Case & Patches	\$44.95
ECG1WT	Electrocardiogram Heart Monitor, Factory Assembled & Tested	\$89.95
ECGP10	Electrocardiogram Re-Usable Probe Patches, 10-Pack	\$4.95

## Digital Voice Changer

This voice changer kit is a riot! Just like the expensive units you hear the DJ's use, it changes your voice with a multitude of effects! You can sound just like a robot, you can even ad vibrato to your voice! 1.5W speaker output plus a line level output! Runs on a standard 9V battery.

MK171 Voice Changer Kit \$14.95



## Steam Engine & Whistle

Simulates the sound of a vintage steam engine locomotive and whistle! Also provides variable "engine speed" as well as volume, and at the touch of a button the steam whistle blows! Includes speaker. Runs on a standard 9V battery.

MK134 Steam Engine & Whistle Kit \$11.95



## 5A PWM Motor Controller

This handy controller uses a pulse width modulated output to control the speed of a motor without sacrificing torque! Handles a continuous current of 5A and includes an LED to indicate speed, as well as an oversized gold heatsink! Also available factory assembled.

CK1102 5A PWM Motor Controller Kit \$14.95

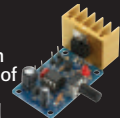

## Digital LED Thermometer

This handy thermometer reads Celsius or Fahrenheit on an eye-catching .56" LED display! Based on the DS18B20 sensor and controlled by a PIC, it has a range of -67°F to 257°F (-55°C to 125°C) with a wired remote range of 325 feet!

CK127 Digital LED Thermometer Kit \$29.95



## Laser Trip Senser Alarm

True laser protects over 500 yards! At last within the reach of the hobbyist, this neat kit uses a standard laser pointer (included) to provide both audible and visual alert of a broken path. 5A relay makes it simple to interface! Breakaway board to separate sections.

LTS1 Laser Trip Sensor Alarm Kit \$29.95



## Electronic Watch Dog

A barking dog on a PC board! And you don't have to feed it! Generates 2 different selectable barking dog sounds. Plus a built-in mic senses noise and can be set to bark when it hears it! Adjustable sensitivity! Unlike the Saint, eats 2-8VAC or 9-12VDC, it's not fussy!

K2655 Electronic Watch Dog Kit \$39.95



# The Learning Center!

PL130A

PL200

PL300

SM200K

AMFM108K

PL500

SP1A

AM2

AMFM7

SR3

AK870

## Beginners To Advanced... It's Fun!

- ✓ Learn, build, and enjoy!
- ✓ 130, 200, 300, & 500 in one electronic labs!
- ✓ Practical through hole and SMT soldering labs!
- ✓ Integrated circuit AM/FM radio lab!
- ✓ AM, AM/FM, and SWL radio labs!
- ✓ Radio Controlled (RC) car!
- ✓ Beginner's non-soldering kits!

For over 4 decades we've become famous for making electronics fun, while at the same time making it a great learning experience. As technology has changed over these years, we have continued that goal!

**PL130A** Gives you 130 different electronic projects together with a comprehensive learning manual describing the theory behind all the projects.

**PL200** Includes 200 very creative fun projects and includes a neat interactive front panel with 2 controls, speaker, LED display and a meter.

**PL300** Jump up to 300 separate projects that start walking you through the learning phase of digital electronics.

**PL500** The ultimate electronics lab that includes 500 separate projects that cover it all, from the basics all the way to digital programming.

**SP1A** Whether young or old, there's always a need to hone your soldering skills. Either learn from scratch or consider it a refresher, and end up with a neat little project when you're done!

**SM200K** Move up to Surface Mount Technology (SMT) soldering, and learn exactly how to solder those tiny little components to a board!

**AMFM108K** We not only take you through AM and FM radio theory but we guide you through IC's. When you're done you've built yourself an IC based AM/FM radio that works great!

**AM2** Learn the complete theory of AM broadcast radio and end up with a highly sensitive AM radio receiver!

**AMFM7** Step up to AM/FM with this multi-band lab and learn the basics of both bands. The FM tuner is factory assembled and aligned!

**SR3** Enter the world of SWL with this short-wave radio learning lab covering 6-8MHz and 12-18MHz!

**AK870** One of the most exciting electronic learning kits that the kids will love! Build a complete RC speedster from the ground up! 7 remote functions!

PL130A	130-In-One Lab Kit	\$39.95
PL200	200-In-One Lab Kit	\$84.95
PL300	300-In-One Lab Kit	\$109.95
PL500	500-In-One Lab Kit	\$249.95
SP1A	Through Hole Soldering Lab	\$9.95
SM200K	SMT Practical Soldering Lab	\$22.95
AMFM108K	AM/FM IC Lab Kit & Course	\$36.95
AM2	AM Radio Learning Lab	\$11.95
AMFM7	AM/FM Radio Learning Lab	\$12.95
SR3	Short Wave Radio Learning Lab	\$16.95
AK870	RC Speedster Car Kit	\$29.95



Where Electronics...  
Is Always Fun!

- ✓ Build It!
- ✓ Learn It!
- ✓ Achieve It!
- ✓ Enjoy It!

## Follow Us and SAVE \$\$

Follow us on your favorite network site and look for a lot of super deals posted frequently... exclusively for our followers!



## 4-Channel USB Relay Controller Board

- ✓ Individually configurable I/O channels!
- ✓ Compatible with DS18B20 temp sensors!
- ✓ USB control for your custom applications!

This professional quality USB relay controller and data acquisition module allows computer controlled switching of external devices, plus full bi-directional communication with the external world using the USB port of your computer. The controller is very flexible and can be used for a wide range of custom applications, including weather stations, temperature monitoring, logging and control, etc.

It is compatible with both Windows and Apple OS X, as well as various Linux flavors. When you plug it into your computer, it appears as a USB CDC device that creates a Virtual Serial (COM) port allowing easy communication with the board through any programming language that supports serial communications (VB, VB.NET, C#, C, C++, Perl, Java, etc).

The controller features four onboard relay outputs with a current rating of 10A each. Also onboard is a 6-channel Input/Output interface, with each channel individually configurable as Digital Input, Digital Output, Analog Input (10-bit Resolution), or DS18B20 series Temperature Sensor.

In Digital Input/Output modes, each channel can support a TTL compatible or ST input or a 5V output signal. In Analog Input mode, each channel can convert a voltage of between 0 to 5V into a 10-bit digital representation. Finally, in Temperature Sensor mode, each channel can be connected to a DS18B20 series Digital Temp Sensor.

### UK1104 4-Ch USB Relay Interface Kit

\$59.95

## RF Preamplifier

The famous RF preamp that's been written up in the radio & electronics magazines! This super broadband preamp covers 100 KHz to 1000 MHz! Unconditionally stable gain is greater than 16dB while noise is less than 4dB! 50-75 ohm input. Runs on 12-15 VDC.

### SA7 RF Preamp Kit

\$16.95

## Mad Blaster Warble Alarm

If you need to simply get attention, the "Mad Blaster" is the answer, producing a LOUD ear shattering raucous racket! Super for car and home alarms as well. Drives any speaker. Runs on 9-12VDC.

### MB1 Mad Blaster Warble Alarm Kit

\$9.95

## Water Sensor Alarm

This little \$7 kit can really "bail you out"! Simply mount the alarm where you want to detect water level problems (sump pump)! When the water touches the contacts the alarm goes off! Sensor can even be remotely located. Runs on a standard 9V battery.

### MK108 Water Sensor Alarm Kit

\$6.95

## Air Blasting Ion Generator

Generates negative ions along with a hefty blast of fresh air, all without any noise! The steady state DC voltage generates 7.5kV DC negative at 400uA, and that's LOTS of ions! Includes 7 wind tubes for max air! Runs on 12-15VDC.

### IG7 Ion Generator Kit

\$64.95

## Tri-Field Meter Kit

"See" electrical, magnetic, and RF fields as a graphical LED display on the front panel! Use it to detect these fields in your house, find RF sources, you name it. Featured on CBS's Ghost Whisperer to detect the presence of ghosts! Req's 4 AAA batteries.

### TFM3C Tri-Field Meter Kit

\$74.95

## Electret Condenser Mic

This extremely sensitive 3/8" mic has a built-in FET preamplifier! It's a great replacement mic, or a perfect answer to add a mic to your project. Powered by 3-15VDC, and we even include coupling cap and a current limiting resistor! Extremely popular!

### MC1 Mini Electret Condenser Mic Kit

\$3.95

## Touch Switch

Touch on, touch off, or momentary touch hold, it's your choice with this little kit! Uses CMOS technology. Actually includes TWO totally separate touch circuits on the board! Drives any low voltage load up to 100mA. Runs on 6-12 VDC.

### TS1 Touch Switch Kit

\$9.95

## Laser Light Show

Just like the big concerts, you can impress your friends with your own laser light show! Audio input modulates the laser display to your favorite music! Adjustable pattern & speed. Runs on 6-12VDC.

### LLS1 Laser Light Show Kit

\$49.95

## USB DMX Interface

Control DMX fixtures with your PC via USB! Controls up to 512 DMX channels each with 256 different levels! Uses standard XLR cables. Multiple fixtures can be simply daisy chained. Includes Light Player software for easy control. Runs on USB or 9V power.

### K8062 USB DMX Interface Controller Kit

\$67.95

## Tickle-Stick Shocker

The kit has a pulsing 80 volt tickle output and a mischievous blinking LED. And who can resist a blinking light and an unlabeled switch! Great fun for your desk, "Hey, I told you not to touch!" Runs on 3-6 VDC.

### TS4 Tickle Stick Kit

\$9.95

## Passive Aircraft Monitor

The hit of the decade! Our patented receiver hears the entire aircraft band without any tuning! Passive design has no LO, therefore can be used on board aircraft! Perfect for air-shows, hears the active traffic as it happens! Available kit or factory assembled.

### ABM1 Passive Aircraft Receiver Kit

\$89.95

## Sniff-It RF Detector Probe

Measure RF with your standard DMM or VOM! This extremely sensitive RF detector probe connects to any voltmeter and allows you to measure RF from 100kHz to over 1GHz! So sensitive it can be used as a RF field strength meter!

### RF1 Sniff-It RF Detector Probe Kit

\$27.95

## Classic Nixie Tube Clocks

Our next generation of classic Nixie tube clocks perfectly mesh today's technology with the Nixie era technology of the 60's. Of course, features you'd expect with a typical clock are all supported with the Nixie clock... and a whole lot more! The clocks are programmable for 12 or 24 hour mode, various AM/PM indications, programmable leading zero blanking, and include a programmable alarm with snooze as well as date display, 4 or 6 tube, kit or assembled!

We then jumped the technological time line of the 60's Nixie displays by adding the latest multi-colored LEDs to the base of the Nixie tubes to provide hundreds of illumination colors to highlight the glass tubes! The LED lighting can be programmed to any color and brightness combination of the colors red, green, or blue to suit your mood or environment. Then we leaped over the technological time line by integrating an optional GPS time base reference for the ultimate in clock accuracy! The small optional GPS receiver module is factory assembled and tested, and plugs directly into the back of the clock to give your Nixie clock accuracy you could only dream of! The clocks are available in our signature hand rubbed Teak & Maple, polished aluminum, or clear acrylic bases.

### NIXIE Classic Nixie Tube Clock Kits From \$229.95

## USB PIC Programmer

Finally, a compact USB PIC Programmer with a 20 pin ZIF socket for easy programming of most Microchip PIC Flash devices that does not require low voltage programming. Plus it uses USB therefore no more RS232 compatibility issues!

### CK1301 USB PIC Programmer Kit

\$34.95

## HV Plasma Generator

Generate 2" sparks to a handheld screwdriver! Light fluorescent tubes without wires! This plasma generator creates up to 25kV at 20kHz from a solid state circuit! Build plasma bulbs from regular bulbs and more! Runs on 16VAC or 5-24VDC.

### PG13 HV Plasma Generator Kit

\$64.95

## Speedy Speed Radar Gun

Our famous Speedy radar gun teaches you doppler effect the fun way! Digital readout displays in MPH, KPH, or FPS. You supply two coffee cans! Runs on 12VDC or our AC121 supply.

### SG7 Speed Radar Gun Kit

\$74.95

## Broadband RF Preamp

Need to "perk-up" your counter or other equipment to read weak signals? This preamp has low noise and yet provides 25dB gain from 1MHz to well over 1GHz. Output can reach 100mW! Runs on 12 volts AC or DC or the included 110VAC PS. Asmb.

### PR2 Broadband RF Preamp

\$69.95

## OBDII CarChip Pro

The incredible OBDII plug-in monitor that has everyone talking! Once plugged into your vehicle it monitors up to 300 hours of trip data, from speed, braking, acceleration, RPM and a whole lot more. Reads and resets your check engine light, and more!

### 8226 CarChip Pro OBDII Monitor-Asmb \$79.00

GET THE INUTS AND VOLTS DISCOUNT!

Mention or enter the coupon code **NVRMZ12** and receive 10% off your order!

800-446-2295  
www.ramseykits.com

Prices, availability, and specifications are subject to change. Not responsible for typos, mistakes, stupid, or New Year's morning headaches! Robin gets cool this year for making me get this ad copy done in early December! Visit www.ramseykits.com for the latest pricing, specials, terms and conditions. Copyright 2013 Ramsey Electronics™, so there!

RAMSEY ELECTRONICS®

590 Fishers Station Drive  
Victor, NY 14564  
(800) 446-2295  
(585) 924-4560

## Audio Kits for Electronics Enthusiasts

### 45 Second Voice Recorder Kit

Cat. KC-5454

This kit easily records two, four or eight different messages for random-access playback or a single message for 'tape mode' playback. It also provides cleaner and glitch-free line-level audio output suitable for feeding an amplifier or PA system. It can be powered from any source of 9-14V DC.

- Supplied with silk screened and solder masked PCB and all electronic components
- PCB: 120 x 58mm

**\$25.25\***

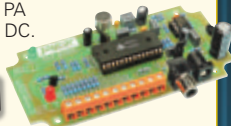

**Popular Kit!**

### Theremin Synthesiser Kit MkII

Cat. KC-5475

Create your own eerie science fiction sound effects by simply moving your hand near the antenna. Easy to set up and build. Complete kit contains PCB with overlay, pre-machined case and all specified components.

- PCB: 85 x 145mm

**\$54.00\***



**Best Seller!**

### Digital Audio Delay Kit

Cat. KC-5506

Corrects sound and picture synchronization ("lip sync") between your modern TV and home theatre system. Features an adjustable delay

from 20 to 1500ms in 10ms steps, and handles Dolby Digital AC3, DTS and linear PCM audio with sampling rate of up to 48kHz. Connections include digital S/PDIF and optical Toslink connections, and digital processing means there is no audio degradation. Kit includes PCB with overlay a pre-soldered SMD IC, enclosure with machined panels, and electronic components.

- 9-12VDC power supply required
- Universal IR remote required
- PCB: 103 x 118mm

**\$72.00\***



### "The Champ" Audio Amplifier Kit

Cat. KC-5152

This tiny module uses the LM386 audio IC, and will deliver 0.5W into 8 ohms from a 9V supply making it ideal for all those basic audio projects. It features variable gain, will happily run from 4-12VDC and is smaller than a 9V battery, allowing it to fit into the tightest of spaces.

- PCB and electronic components included
- PCB: 46 x 26 mm

**\$6.00\***



### SD Card Speech Recorder/Player Kit

Cat. KC-5481

Use this kit to store your WAV files on MMC/SD/SDHC cards. It can be used as a jukebox, a sound effects player or an expandable digital voice recorder. You can use it as a free-standing recorder or in conjunction with any Windows, MAC® or Linux PC.

- Short form kit includes overlay PCB, SD card socket and electronic components
- Compatible with SD, SDHC or MMC cards
- PCB: 164 x 136mm

**\$54.00\***

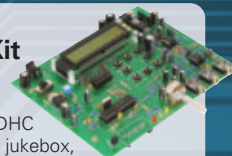

### Full Function Smart Card Reader / Programmer Kit

Cat. KC-5361

This full function programmer allows you to program both the microcontroller and EEPROM in the popular gold, silver and emerald wafer cards. It connects to the serial port of your PC and is supplied with PCB, wafer card socket and electronic components.

- Requires RS232 cable
- PCB: 141 x 101mm

**\$34.50\***



NOTE: Jaycar Electronics and Silicon Chip Magazine will not accept responsibility for the operation of this device, its related software, or its potential to be used for unlawful purposes.

### High Performance 250WRMS Class-D Amplifier Kit

Cat. KC-5514

High quality amplifier boasting 250WRMS output into 4 ohms, 150W into 8 ohms and can be bridged with a second kit for 450W into 8 ohms. Features include high efficiency (90% @ 4 ohm), low distortion and noise (<0.01%), and over-current, over-temperature, under voltage, over-voltage and DC offset protection. Kit supplied with double sided, soldermasked and screenprinted silk-screened PCB with SMD IC pre-soldered, heatsink, and electronic circuit board mounted components.

- Power requirements: +/- 40 to 60VDC, 50 to 55V nominal (see KC-5471)
- S/N ratio: 103dB
- Freq. response: 10Hz - 10kHz, +/- 1dB
- PCB dimensions: 117 x 167mm

**\$65.00\***

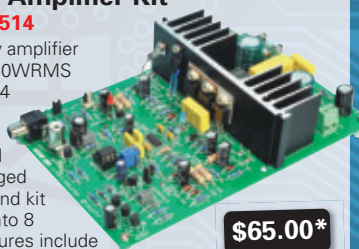

Also available:

- Stereo Speaker Protector Kit to suit **NEW KC-5515 \$21.75**
- +/- 55V Power Supply Kit to suit **KC-5471 \$21.75**

### "Minivox" Voice Operated Relay Kit

Cat. KC-5172

Voice operated relays are used for 'hands free' radio communications and some PA applications etc. Instead of pushing a button, this device is activated by the sound of a voice. This tiny kit fits in the tightest spaces and has almost no turn-on delay. 12VDC @ 35mA required. Kit is supplied with PCB electret mic, and all specified components.

- PCB: 47 x 44mm

**\$11.50\***



### The Super Ear Kit

Cat. KA-1809

This kit assists people who have difficulty in hearing high audio frequencies, or for those who want to hear more than their normal unaided ear. By amplifying these high audio frequencies, not only will conversations be made clearer, you will be able to hear noises not normally heard such as insects or a watch ticking, for example. Built into a small case and powered from a 9V battery makes this kit totally portable. Use it as a hearing aid or for a fun & educational purpose.

- Kit supplied with case, front label, PCB, 9V battery, and all electronic components.
- Headphones required
- PCB: 56 x 26mm

**\$20.25\***

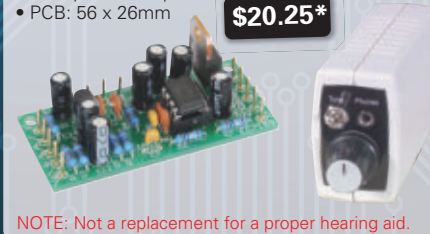

NOTE: Not a replacement for a proper hearing aid.

## NOW SHIPPING VIA DHL

• FAST DELIVERY • TRACK SHIPMENT

### Post & Packing Charges

Order Value	Cost
\$25 - \$49.99	\$7.50
\$50 - \$99.99	\$20
\$100 - \$199.99	\$40
\$200 - \$499.99	\$60
\$500+	\$75

- Max weight 12lb (5kg).
- Heavier parcels POA.
- Minimum order \$25.

### HOW TO ORDER

**WEB:** [www.jaycar.us](http://www.jaycar.us)  
**PHONE:** 1-800-784-0263\*  
**FAX:** +61 2 8832 3118\*  
**EMAIL:** [techstore@jaycar.com](mailto:techstore@jaycar.com)  
**POST:** P.O. Box 107, Rydalmere NSW 2116 Australia

**5-10 working day delivery**

\*Australian Eastern Standard Time (Monday - Friday 09.00 to 17.30 GMT + 10 hours)

• ALL PRICING IN US DOLLARS      Prices valid until 31/1/2013

**\*All prices EXCLUDE postage & packing**